



STELLS

CATÁLOGO 2020

A Toolsworld foi fundada em Moscou no ano de 1995, seu primeiro escritório de vendas fora do país está localizado no Cazaquistão, em 2011 e conta hoje com uma gama de produtos superior a 8.000 itens divididos por segmentos como: ferramentas manuais, ferramentas elétricas e produtos domésticos.

Toolsworld was founded in Moscow in the year 1995, its first offshore sales office is located in Kazakhstan in 2011 and today has a product range of more than 8.000 items divided by segments such as: hand tools, power tools and household products.

A Toolsworld fue fundada en Moscú en el año 1995, su primera oficina de ventas fuera del país se encuentra en Kazajstán en 2011 y cuenta hoy con una gama de productos superior a 8.000 elementos divididos por segmentos como: herramientas manuales, herramientas eléctricas y productos domésticos.

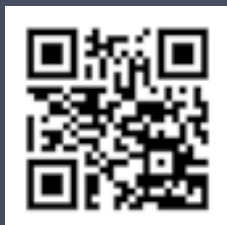

WWW.TOOLSWORLD.COM.BR
WWW.INSTRUMENT.RU

Siga também nossas redes sociais



Viela Urga, 810 - Guarulhos
Bonsucesso - Cep 07175-332
Telefone: + 55 11 2466-8080
SAC: 0800 777 8 999
email@toolsworld.com.br





Um mundo de ferramentas para o seu negócio.

A Toolsworld atende todo o território nacional com uma equipe altamente capacitada e pronta para atender o cliente que procura sempre ferramentas ergonomicamente produzidas e voltadas aos consumidores e profissionais dos mais variados segmentos. A qualidade está presente em todos os nossos produtos espalhados pelo mundo.



A world of instruments for yours business.

Toolsworld serves the entire territory national team with a highly capable and ready to serve the client always looking for tools ergonomically produced and aimed at consumers and segments. Quality is present in all our products all over the world.



Un mundo de instrumentos para el tuyo negocio.

Toolsworld atende todo el territorio nacional con un equipo altamente capacitada y lista para atender al cliente que busca siempre herramientas ergonomicamente producidas y para los consumidores y los profesionales de los más variados segmentos. La calidad está presente en todos los nuestros productos esparcidos por todo el mundo.



SOBRE NÓS

A TOOLSWORLD foi fundada em 1995 em Moscou com a premissa de atender o mercado nacional com ferramentas manuais de alta qualidade e com os melhores preços do mercado. Não demorou muito e logo a produção das ferramentas para o mercado interno já ficou pequeno e a empresa partiu em 2011 para uma expansão global abrindo seu primeiro escritório de vendas no Cazaquistão e posteriormente na Romênia e Bielorrússia, em 2018 novos escritórios na Romênia, Polônia, Hungria e Uzbequistão. Neste ano a empresa continua a sua expansão com abertura de escritórios nos Estados Unidos e Emirados Árabes Unidos.

Na mesma velocidade de expansão do mercado as linhas de produto cresceram e neste mesmo ano o catálogo de produtos ultrapassou 8.000 itens das marcas: Matrix (Brasil: MTX), GROSS, SPARTA, PALISAD, PALISAD LUXE, PALISAD CAMPING, STELS, DENZEL, ELFÉ, STERN, SIBROTEH, BARS, RÚSSIA, KRONWERK que se dividem em ferramentas manuais, elétricas, fixadores, jardinagem agrícola e produtos domésticos.

Seguindo este crescimento e utilizando tecnologias avançadas, aprimoramento constante de processos de produção e controle de qualidade, trouxeram um aumento significativo do volume de negócios, vendas e experiência que nos credenciaram para entrega dos mais altos níveis de serviços que satisfaçam as necessidades de nossos clientes e consumidores.

SOBRE NOSOTROS

TOOLSWORLD fue fundada en 1995 en Moscú con la premisa de atender el mercado nacional con herramientas manuales de alta calidad y con los mejores precios del mercado. No tardó mucho y luego la producción de las herramientas para el mercado interno ya se hizo pequeña y la empresa partió en 2011 para una expansión global abriendo su primera oficina de ventas en Kazajstán y posteriormente en Rumania y Bielorrusia en 2018 nuevas oficinas en Rumania, Polonia, Hungría y Uzbekistán. Este año la empresa continúa su expansión con apertura de oficinas en Estados Unidos y Emiratos Árabes Unidos.

En la misma velocidad de expansión del mercado las líneas de producto crecieron y este mismo año el catálogo de productos sobrepasó 8.000 ítems de las marcas: Matrix (Brasil: MTX), GROSS, SPARTA, PALISAD, PALISAD CAMPING, STELS, DENZEL, ELFÉ, STERN, SIBROTEH, BARS, RUSIA, KRONWERK que se dividen en herramientas manuales, eléctricas, fijadores, jardinería agrícola y productos domésticos.

Siguiendo este crecimiento y utilizando tecnologías avanzadas, perfeccionamiento constante de procesos de producción y control de calidad, han traído un aumento significativo del volumen de negocios, ventas y experiencia que nos han acreditado para la entrega de los más altos niveles de servicios que satisfagan las necesidades de nuestros clientes y los consumidores.

ABOUT US

TOOLSWORLD was founded in 1995 in Moscow with the premise of serving the national market with high quality hand tools at the best prices on the market. It did not take long and soon the production of the tools for the internal market was already small and the company started in 2011 for a global expansion opening its first sales office in Kazakhstan and later in Romania and Belarus in 2018 new offices in Romania, Poland, Hungary and Uzbekistan. This year the company continues its expansion with opening offices in the United States and United Arab Emirates.

At the same speed of expansion of the market the product lines grew and in that same year the product catalog surpassed 8,000 items of brands: Matrix (Brazil: MTX), GROSS, SPARTA, PALISAD, PALISAD LUXE, PALISAD CAMPING, STELS, DENZEL, ELFÉ, STERN, SIBROTEH, BARS, RUSSIA, KRONWERK which are divided into hand tools, electrical, fasteners, agricultural gardening and household products.

Following this growth and using advanced technologies, constant improvement of production processes and quality control, have brought a significant increase in the volume of business, sales and experience that have accredited us to deliver the highest levels of services that meet the needs of our customers and consumers.



1

FERRAMENTAS DE BANCADA

BENCH TOOLS | HERRAMIENTAS DE BANCADA

PGS 9-64



2

FERRAMENTAS DE CARPINTEIRO

CARPENTER TOOLS | HERRAMIENTAS DE CARPINTERO

PGS 65-72



3

FERRAMENTAS DE MEDIÇÃO

MEASURING TOOLS | HERRAMIENTAS DE MEDICIÓN

PGS 73-84



4

FERRAMENTAS DE MONTAGEM

INSTALLATION TOOLS | HERRAMIENTAS DE MONTAJE

PGS 85-92



5

FERRAMENTAS AUTOMOTIVAS

AUTOMOTIVE TOOLS | HERRAMIENTAS AUTOMOTORES

PGS 93-128



6

FERRAMENTAS DE JARDIM

GARDEN TOOLS | HERRAMIENTAS DE JARDÍN

PGS 129-150



7

FERRAMENTAS DE CORTE

CUTTING TOOLS | HERRAMIENTAS DE CORTE

PGS 151-196



8

FERRAMENTAS CONSTRUÇÃO E ACABAMENTO

CONSTRUCTION AND FINISHING TOOLS
HERRAMIENTAS CONSTRUCCIÓN Y ACABADO

PGS 197-206



9

ACESSÓRIOS DE FERRAMENTAS

TOOL ACCESSORIES
ACCESORIOS DE HERRAMIENTAS

PGS 207-214



INFORMAÇÕES GERAIS

GENERAL INFORMATION
INFORMACIONES GENERALES

PGS 215-232



SIMBOLOGIA TÉCNICA

TECHNICAL SYMBOLS | SIMBOLOGÍA TÉCNICA

PRINCIPAL



CÓDIGO
CODE



CARACTERÍSTICAS
Technical Features



PESO CABEÇA
Head Weight
Peso Cabeça



PESO TOTAL
Total Weight



PESO TOTAL
Total Weight
Peso Total



CAIXA MASTER
Box Master | Caja Máster



QUANT. MINÍMA
Quant. Minimum
Cantidad Mínimo



DIÂMETRO
Diameter
Diámetro



PERFIL FENDA
Fenda profile | Perfil fenda



PERFIL PHILLIPS
Profile phillips | Perfil phillips



PERFIL POZIDRIVE
Profile pozidrive | Perfil pozidrive



PERFIL TORX - bit/ponta
Profile TORX - bit/tip
Perfil TORX - bit/punta



PERFIL TORX com guia
Profile TORX with guide
Perfil TORX con guía



PERFIL TORX soquete/encaixe
Profile TORX socket / fitting
Perfil TORX enchufe / encajar



PERFIL SEXTAVADO bit/ponta
Profile Six point bit/tip
Perfil sextavado bit/punta



PERFIL SEXTAVADO soquete/encaixe
Profile Six point socket / fitting
Perfil sextavado enchufe / encaja



PERFIL SEXTAVADO soquete/encaixe
Profile Six point socket / fitting
Perfil sextavado enchufe / encaja



PERFIL SEXTAVADO com guia
Profile Six point with guide
Perfil sextavado con guía



PERFIL BI-SEXTAVADO soquete/encaixe
Profile twelve point socket / fitting
Perfil bi-sextavado enchufe / encaja



PERFIL SPLINE soquete/encaixe
Profile SPLINE socket / fitting
Perfil SPLINE enchufe / encaja



PERFIL SPLINE bit/ponta
Profile SPLINE point bit/tip
Perfil SPLINE bit/punta



PERFIL SPANNER bit/ponta
Profile SPANNER point bit/tip
Perfil SPANNER bit/punta



PERFIL SPAN bit/ponta
Profile SPAN point bit/tip
Perfil SPAN bit/punta



USO PARA FERRAMENTAS PNEUMÁTICAS
Use for pneumatic tools
Uso para herramientas neumáticas



EMBALAGEM TIPO BLISTER
Blister type packaging
Embalaje tipo blister

BLISTER



ENCAIXE SDS MAX
Socket SDS MAX
Encaje SDS MAX



ENCAIXE SDS PLUS
Socket SDS PLUS
Encaje SDS PLUS



ÁÇO CROMO-VANÁDIO
Steel chromo-vanádio | Acero cromado-vanadio



ÁÇO CROMO-MOLIBDÊNIO
Chrome-molybden steel | Acero cromado-molibdenio



ÁÇO S2
S2steel | Acero S2



ÁÇO FORJADO - DUREZA 45HRc
Forged steel - hardness 45hrc
Acero forjado - dureza 45hrc



ÁÇO CARBONO
Carbon steel
Acero carbono



GRAU DE DUREZA DO AÇO
Strength of steel hardness
Grado de dureza del acero



IMÃ MINEDIN
Magnet minedin
Ímã minedin



PARA TRABALHOS EM ÁREAS COM VOLTAGEM DE ATÉ 1000V
For work in areas with voltage up to 1000V
Para trabajos en áreas con voltagen de hasta 1000V



PADRÃO INTERNACIONAL DE SEGURANÇA PARA PRODUTOS ELETRO-ELETRÔNICOS

International standard of safety for electronic-electronic products

Estándar internacional de seguridad para productos electrón-electrónicoS



NORMA INTERNACIONAL IEC 60900:2004 PARA PRODUTOS ELETRO-ELETRÔNICOS

International standard iec 60900: 2004 For electronic-electronic products

Norma internacional iec 60900: 2004 Para productos electrón-electrónicoS



INSTITUTO ALEMÃO PARA NORMATIZAÇÃO

O uso da norma DIN, bem como de outras normas internacionais, assegura um padrão de qualidade na fabricação de produtos e equipamentos, refletindo diretamente na segurança do consumidor final.

GERMAN INSTITUTE FOR NORMATIZATION The use of the DIN standard, as well as other international standards, ensures a quality standard in the manufacture of products and equipment, directly reflecting the safety of the final consumer.

INSTITUTO ALEMÁN PARA NORMATIZACIÓN El uso de la norma DIN, así como de otras normas internacionales, asegura un estándar de calidad en la fabricación de productos y equipos, reflejando directamente en la seguridad del consumidor final.



CANAL DA POEIRA

COM FELIPE MIRANDA

Este é um canal para mostrar, ensinar e inspirar, no melhor estilo faça você mesmo (DIY), usando madeira, metal, espuma, resinas e qualquer outro material para deixar a nossa casa, escritório ou oficina ainda mais incrível.

Durante o processo ensinamos técnicas de marcenaria, serralheria e muito mais.

Também fazemos testes de equipamentos, dando uma opinião sempre sincera sobre o produto apresentado.

Tudo isso sem enrolação e indo direto ao ponto.

Já comentei várias vezes nos vídeos do canal que a MTX tem uma grande variedade de ferramentas de qualidade e ensino a a utilizar várias ferramentas da marca.

Para conhecer a linha completa, acesse o site:
<http://toolsworld.com.br/brand/MTX/>

Os produtos MTX estão a venda nas melhores lojas do ramo, em todo o território nacional.

 **mtx**®
FERRAMENTAS CONFIÁVEIS

FAÇA ALGO NOVO,
FAÇA VOCÊ MESMO.

ASSISTA AOS MEUS
VÍDEOS ENSINANDO O
USO DAS FERRAMENTAS





GARANTIA DE PERFEIÇÃO!

A marca GROSS tem as melhores ferramentas profissionais do mercado!



BANCADA

BENCH | BANCADA

FERRAMENTAS DE BANCADA

BENCH'S TOOLS
HERRAMIENTAS DE BANCADA

As ferramentas de bancada GROSS, MTX e SPARTA, proporcionam ao profissional ou consumidor final um produto de extrema eficiência para o trabalho a ser desenvolvido. Utilizando matérias primas de qualidade as ferramentas tem um ótimo desempenho e proporcionam um excelente resultado.

The GROSS, MTX and SPARTA benchtop tools provide the professional or final consumer with an extremely efficient product for the work to be done. Using quality raw materials the tools have a great performance and provide an excellent result.

Las herramientas de banco GROSS, MTX y SPARTA, proporcionan al profesional o consumidor final un producto de extrema eficiencia para el trabajo a ser desarrollado. Utilizando materias primas de calidad las herramientas tienen un óptimo desempeño y proporcionan un excelente resultado.

SIMBOLOGIA



CÓDIGO
CODE



CARACTERÍSTICAS
Technical Features



PESO CABEÇA
Head Weight
Peso Cabeza



PESO TOTAL
Total Weight



PESO DA PEÇA
Part Weight
Peso de la Pieza



CAIXA MASTER
Box Master | Caja Máster



QUANT. MINÍMA
Quant. Minimum
Cantidad Mínimo



DIÂMETRO
Diameter
Diámetro



Martelo bola c/ cabo de madeira polida

Ball hammer with polished wood handle | Martillo bola con mango de madera pulida



AÇO FORJADO 45HRc



DIMENSÕES SIZE TAMAÑO (MM)	KG	KG	DIMENSÕES SIZE TAMAÑO (MM)			Quant. Min.	
			A	B	C		
1020055	200g	330g	80	285	20	60	6
1020155	300g	430g	95	300	25	48	6
1020255	400g	580g	100	320	25	48	6
1020355	600g	830g	110	350	30	36	6
1020455	800g	1040g	125	360	30	24	6
1020555	1000g	1290g	130	380	40	24	6



- Extremidades lixadas | Sanded ends | Extremos lijados
- Cabeça envernizada | Varnished head | Cabeza barnizada

Martelo bola c/ cabo emborrachado

Ball hammer with rubber cable | Martillo bola con mango de goma



AÇO FORJADO 55HRc

NORMA DIN 1041



DIMENSÕES SIZE TAMAÑO (MM)	KG	KG	DIMENSÕES SIZE TAMAÑO (MM)			Quant. Min.	
			A	B	C		
1020655	200g	361g	80	285	20	48	6
1020755	300g	467g	90	310	25	36	6
1020855	400g	604g	100	360	25	24	6
1020955	600g	889g	110	310	30	24	6
1021055	800g	1083g	130	350	30	12	6
1021155	1000g	1375g	135	390	40	12	6

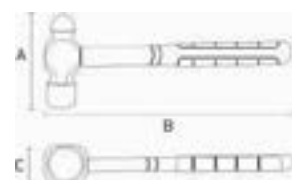

- Extremidades lixadas | Sanded ends | Extremos lijados
- Cabeça envernizada | Varnished head | Cabeza barnizada
- Cabo de fibra de alta resistência com empunhadura de borracha | High-strength fiber cable with rubber grip | Mango de fibra de alta resistencia con empuñadura de goma

Martelo pena cabo de madeira

Machinist's hammer wooden handle | Martillo de pena con mango de madera



AÇO FORJADO 45HRc



DIMENSÕES SIZE TAMAÑO (MM)	KG	KG	DIMENSÕES SIZE TAMAÑO (MM)			Quant. Min.	
			A	B	C		
1020256	100g	169g	80	260	20	120	6
1020456	200g	283g	90	280	20	60	6
1020656	300g	394g	103	300	23	48	6
1020856	400g	512g	110	310	30	48	6

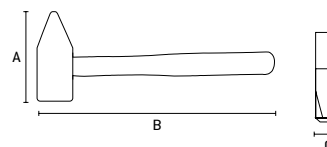

- Cabeça forjada em aço especial. | Forged special steel head | Cabeza forjada en acero especial
- Têmpera na face de impacto e na pena. | Hardened on the striking face and pein | Temple en la base de impacto y en la pena.
- Cabeça com pintura eletrostática. | Head with electrostatic paint finishing | Cabeza con pintura electrostática.
- Fixação por cunha metálica. | Fixed with steel wedge | Fijación con cuña metálica.
- Cabo de madeira envernizado. | Varnished hardwood handle | Mango de madera barnizado

Martelo pena cabo de madeira pintado

Machinist's hammer painted wood cable | Martillo de pena mango de madera pintada



AÇO FORJADO 55HRc

NORMA DIN 1041



DIMENSÕES SIZE TAMAÑO (MM)	KG	KG	DIMENSÕES SIZE TAMAÑO (MM)			Quant. Min.	
			A	B	C		
102279	200g	278g	94	283	20	72	12
102289	300g	690g	104	304	23	48	6
102309	400g	533g	111	313	25	36	6

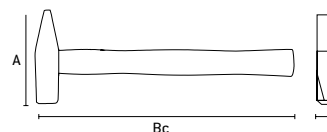

- Têmpera na face de impacto e na pena. | Hardened on the striking face and pein. | Temple en la base de impacto y en la pena
- Cabeça com pintura eletrostática. | Head with electrostatic paint finishing | Cabeza con pintura electrostática.
- Cabo de madeira longo envernizado com desenho anatômico para a diminuição de vibração. | Long varnished wood handle with anatomical design for the decrease of vibration. | Mango de madeira largo barnizado con un diseño anatómico para disminución de la vibración.

Martelo Unha Tubular com cabo emborrachado

Tubular Nail Hammer with Rubberized Cable |
Martillo Uña Tubular con Mango de goma

AÇO FORJADO 45HRc



AÇO CARBONO



antigo	novo	Ø	KG	KG	DIMENSÕES SIZE TAMAÑO (MM)			Quant. Min.
					A	B		
	104403	23	285g	380g	100	240	60	6
	104404	25	345g	460g	110	290	48	6
104405	1044055	27	479g	639g	120	310	36	6

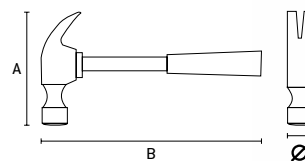

- Cabeça envernizada | Varnished head | Cabeza barnizada
- Cabo de Metal e emborrachado | Rubberized metal cable | Mango de metal y de goma

Martelo unha cabo de madeira

Claw hammer wooden handle |
Martillo uña mango de madera



AÇO FORJADO 45HRc



novo	Ø	KG	KG	DIMENSÕES SIZE TAMAÑO (MM)			Quant. Min.
				A	B		
104104	20	247g	330g	100	299	72	6
1041055	22	248g	340g	105	300	72	6
104106	25	375g	500g	127	320	48	6
1042055	27	467g	622g	130	325	36	6
104206	29	563g	750g	140	345	24	6

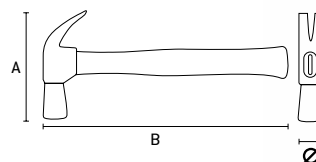

- Cabo de madeira envernizada | Varnished wood cable | Mango de madeira barnizada
- Desenho anatômico para diminuir vibração | Anatomical design to decrease vibration | Diseño anatómico para disminuir la vibración
- Cabeça polida | Polished head | Cabeza pulida

Martelo unha Cabo de fibra

Claw hammer Fiber cable | Martillo uña mango de fibra



AÇO FORJADO 55HRc



	Ø	KG	KG	DIMENSÕES SIZE TAMAÑO (MM)			Quant. Min.
				A	B		
1040555	20	260g	347g	100	275	60	6
1040655	23	329g	438g	120	300	48	6
1040755	25	396g	528g	130	325	36	6
1040855	27	479g	639g	135	330	36	6
1040955	29	594g	792g	140	335	24	6

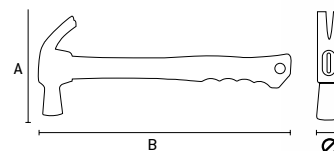

- Cabeça polida | Polished head | Cabeza pulida
- Cabo em fibra de alta resistência | High strength fiber cable | Mango de fibra de alta resistencia
- Empunhadura em borracha termoplástica | Thermoplastic rubber grip | Empuñadura de caucho termoplástico

Martelo unha Cabeça Imantada

Claw Hammer Head Magnet | Martelo unha Cabeça imã



AÇO FORJADO 55HRc



	Ø	KG	KG	DIMENSÕES SIZE TAMAÑO (MM)			Quant. Min.
				A	B		
104469	27	554g	738g	132	330	36	6

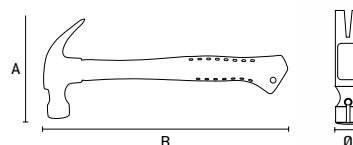

- Cabeça polida | Polished head | Cabeza pulida
- Cabo em fibra de alta resistência | High strength fiber cable | Cable de fibra de alta resistencia
- Empunhadura em borracha termoplástica | Thermoplastic rubber grip | Empuñadura de caucho termoplástico

Encaixe imantado para apoio de pregos com cabeça
Magnetic fitting for nail head support
Enganche imantado para apoyo de clavos con cabeza



Marreta Quadrada
Square Mallet | Mazza cuadrado



AÇO FORJADO 55HRc

NORMA DIN 6475



NOVO	KG	KG	DIMENSÕES SIZE TAMAÑO (MM)			Quant. Min.	
			A	B	Ø		
1090556	1000g	1167g	100	280	30	24	6
1090756	1500g	1667g	110	300	40	12	6
1090956	2000g	2244g	117	320	50	12	6

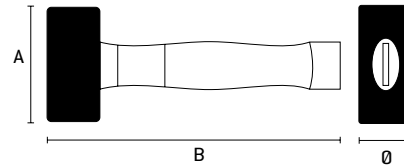

- Cabeça Quadrada | Square head | Cabeza Cuadrada
- Cabo de madeira envernizado | Varnished wood handle | Mango de madera barnizada

Marreta oitavada
Octave hammer | Mazza octava



AÇO FORJADO 55HRc

NORMA DIN 6475



NOVO	KG	KG	DIMENSÕES SIZE TAMAÑO (MM)			Quant. Min.	
			A	B	Ø		
1090155	500 g	518g	80	310	30	36	6
1090555	1000g	1080g	100	330	35	24	6
1090755	1500g	1562g	120	350	40	12	6
1090955	2000g	2100g	130	400	45	12	6
1090655	3000g	3330g	150	605	55	6	0
1090855	5000g	6000g	180	900	60	4	0
1092555	8000g	9500g	200	900	75	2	0

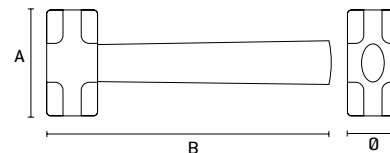

- Cabeça Oitavada | Square head | Cabeza Cuadrada
- Cabo de madeira envernizado | Wood handle varnished | Mango de madera vidriado

Marreta oitavada cabo em fibra
Octave hammer with fiber cable | Marreta octava con mango de fibra



AÇO FORJADO 55HRc



NOVO	KG	KG	DIMENSÕES SIZE TAMAÑO (MM)			Quant. Min.	
			A	B	Ø		
1092655	500g	694g	75	300	30	36	6
1091955	1000g	1208g	100	320	35	24	6
1092055	1500g	1583g	110	370	40	12	6
1092155	2000g	2083g	120	375	50	12	6
1092255	3000g	3833g	150	380	55	6	0

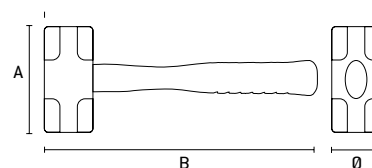

- Cabeça Oitavada | Eighth Head | Cabeza octava
- Cabo em fibra de alta resistência para reduzir o impacto e a vibração transmitidos ao usuário | High strength fiber cable to reduce impact and vibration transmitted to the user | Mango de fibra de alta resistencia para reducir el impacto y la vibración transmitidos al usuario

Marreta Quadrada Cabo de fibra

Square Hammer Fiber Cable |
Marreta cuadrado con mango de fibra



Barcode	Ø	KG	KG	DIMENSÕES SIZE TAMAÑO (MM)		Box	Quant. Min.
				A	B		
109229	58	3000g	3938g	140	910	6	0
109249	70	5000g	5938g	160	910	6	0

AÇO FORJADO 52HRC

NORMA DIN 6475

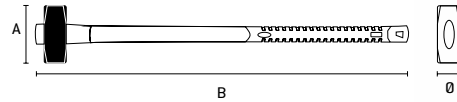

- Aço forjado | Forged steel | Acero forjado
- Cabo em fibra de alta resistência | High strength fiber cable | Mango de fibra de alta resistencia
- Norma DIN 6475 | Standard DIN 6475 | Norma DIN 6475

Martelo Poliuretano anti-retorno

Anti-return polyurethane hammer | Martillo Poliuretano anti-retorno



Barcode	Ø	KG	KG	DIMENSÕES SIZE TAMAÑO (MM)		Box	Quant. Min.
				A	B		
1098555	40	708g		80	290	36	6
1098655	50	917g		110	340	24	6
1098755	60	1000g		120	375	12	6

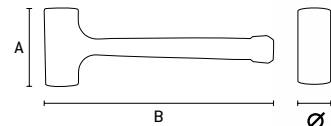

- Anti - retorno | Anti - return | Anti - retorno
- Todo em Poliuretano | All in Polyurethane | Todo en Poliuretano
- Ideal para montagens industriais, martelinho de ouro e funilarias em geral | Ideal for industrial assemblies, gold hammer and funillars in general | Ideal para montajes industriales, martillos de oro y funerales en general

Martelo de borracha cabo de madeira

Rubber hammer with wooden handle |
Martillo de goma con mango de madera



Barcode	Ø	KG	KG	DIMENSÕES SIZE TAMAÑO (MM)		Box	Quant. Min.
				A	B		
1113055	30	225g	305g	80	260	60	12
1114055	40	340g	469g	90	280	48	12
1115055	50	450g	567g	100	320	36	12
1115555	60	680g	846g	110	360	24	6

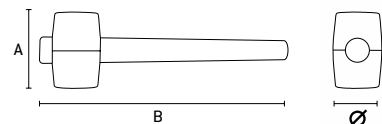

- Cabeça de Borracha | Rubber Head | Cabeza de Goma
- Cabo de madeira pintado e envernizado | Painted wood handle and varnished | Mango de madeira pintado y barnizado

Martelo de borracha Preto e Branco

Black and White Rubber Hammer | Martillo de goma Blanco y negro



Barcode	Ø	KG	DIMENSÕES SIZE TAMAÑO (MM)		Box	Quant. Min.
			A	B		
111709	50	450g	78	287	36	6
111719	60	758g	95	318	24	6
111729	70	1000g	115	342	24	6

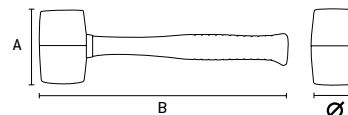

Aplicação: parte branca para porcelanato (não deixa resíduos) e parte preta para cerâmica

Application: white part for porcelain (leaves no residue) and black part for ceramics

Aplicación: parte blanca para porcelanato (no deja residuos) parte negra para la cerámica

- Cabo de fibra com revestimento em borracha termoplástica | Fiber cable with coating in thermoplastic rubber | Mango de fibra con revestimiento de caucho termoplástico



Martelo de borracha p/ Cerâmica

Ceramic Rubber Hammer | Martillo de goma Cerámica



Barcode	Ø	KG	DIMENSÕES SIZE TAMAÑO (MM)		Box	Quant. Min.
			A	B		
111759	50	422g	76	287	36	6
111859	60	742g	96	318	24	6
111939	70	967g	116	342	24	6

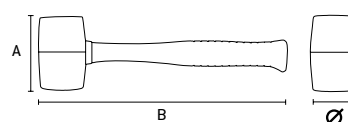

Aplicação: Pisos de Cerâmica

Application: Ceramic floors

Aplicación: Pisos de Cerámica

- Cabeça de Borracha Preto | Black Rubber Head | Cabeza de caucho negro
- Cabo de fibra com revestimento em borracha termoplástica | Fiber cable with coating in thermoplastic rubber | Mango de fibra con revestimiento de caucho termoplástico



Martelo de borracha p/ Porcelanato

Rubber Hammer Porcelain | Martillo de goma Porcelanato



Barcode	Ø	KG	DIMENSÕES SIZE TAMAÑO (MM)		Box	Quant. Min.
			A	B		
111959	50	414g	76	287	36	6
111969	60	742g	95	318	24	6
111979	70	963g	115	342	24	6

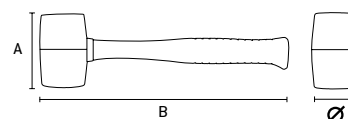

Aplicação: Pisos de porcelanato (não deixa resíduos)

Application: Porcelain flooring (leaves no residue)

Aplicación: Pisos de porcelanato (no deja residuos)

- Cabeça de Borracha Branca | White Rubber Head | Cabeza de caucho Blanco
- Cabo de fibra com revestimento em borracha termoplástica | Fiber cable with coating in thermoplastic rubber | Mango de fibra con revestimiento de caucho termoplástico



Chaves Allen Curta fosfatizada

Allen Key Phosphatized | Chaves Allen fosfatizado



• Acabamento Fosfatizado | Phosphated Finish | Acabado Fosfatizado

Código	Tamanho	DIMENSÕES SIZE TAMAÑO (MM)			Quant. Min.	
		A	B	C		
1120155	1,5 mm - 25 pçs	13	44	1,5	80	0
1120255	2,0 mm - 25 pçs	15	50	2	80	0
1120355	2,5 mm - 25 pçs	18	56	2,5	80	0
1120455	3,0 mm - 25 pçs	22	65	3	80	0
1120555	4,0 mm - 20 pçs	27	72	4	30	0
1122555	5,0 mm - 20 pçs	32	80	5	30	0
1121255	6,0 mm - 20 pçs	37	90	6	20	0
1121455	7,0 mm - 20 pçs	39	101	7	10	0
1121655	8,0 mm - 10 pçs	43	108	8	16	0
1122855	9,0 mm - 10 pçs	45	117	9	12	0
1123055	10,0 mm - 10 pçs	50	123	10	8	0
1123255	12,0 mm - 10 pçs	55	133	12	8	0

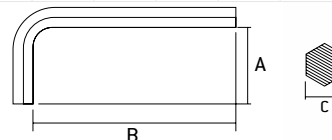

Chaves Allen Longa Abaulada fosfatizada

Allen Key Long Phosphatized | Chaves Allen Larga fosfatizado



• Acabamento Fosfatizado | Phosphated Finish | Acabado Fosfatizado

Código	Tamanho	DIMENSÕES SIZE TAMAÑO (MM)			Quant. Min.	
		A	B	C		
1125655	1,5 mm - 25 pçs	13	70	1,5	80	0
1125755	2,0 mm - 25 pçs	15	77	2	80	0
1125855	2,5 mm - 25 pçs	18	86	2,5	80	0
1125955	3,0 mm - 25 pçs	22	102	3	80	0
1126055	4,0 mm - 20 pçs	27	109	4	30	0
1126155	5,0 mm - 20 pçs	32	123	5	30	0
1126255	6,0 mm - 20 pçs	37	135	6	20	0
1126355	7,0 mm - 20 pçs	39	147	7	12	0
1126455	8,0 mm - 10 pçs	43	157	8	16	0
1126555	9,0 mm - 10 pçs	45	167	9	12	0
1126855	10,0 mm - 10 pçs	50	177	10	8	0
1126755	12,0 mm - 10 pçs	55	187	12	8	0

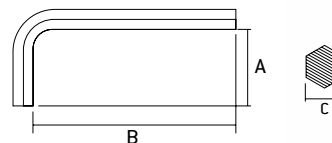

Chaves TORX curta fosfatizado com guia

TORX Key Phosphatized | Chaves TORX fosfatizado



• Acabamento Fosfatizado | Phosphated Finish | Acabado Fosfatizado

Código	Tamanho	DIMENSÕES SIZE TAMAÑO (MM)			Quant. Min.	
		A	B	C		
1127555	T10 - 25 pçs	13	54	15	40	0
1127655	T15 - 25 pçs	15	61	20	40	0
1127755	T20 - 25 pçs	18	66	30	40	0
1127855	T25 - 25 pçs	25	73	35	40	0
1127955	T27 - 10 pçs	29	81	40	50	0
1128055	T30 - 10 pçs	32	90	45	50	0
1128155	T40 - 10 pçs	35	100	50	40	0
1128255	T45 - 5 pçs	43	110	60	40	0
1128355	T50 - 5 pçs	45	127	70	40	0

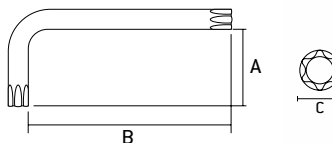

Chaves Torx Longa fosfatizada com guia

Allen Key Phosphatized | Chaves Allen fosfatizado



• Acabamento Fosfatizado | Phosphated Finish | Acabado Fosfatizado

Código	Tamanho	DIMENSÕES SIZE TAMAÑO (MM)			Quant. Min.	
		A	B	C		
1128755	T10 - 25 pçs	13	70	15	40	0
1128855	T15 - 25 pçs	15	77	20	40	0
1128955	T20 - 25 pçs	18	86	30	40	0
1129055	T25 - 25 pçs	25	93	35	40	0
1129155	T27 - 10 pçs	29	109	40	50	0
1129255	T30 - 10 pçs	32	123	45	50	0
1129355	T40 - 10 pçs	35	139	50	50	0
1129455	T45 - 5 pçs	43	155	60	40	0
1129555	T50 - 5 pçs	45	173	70	40	0

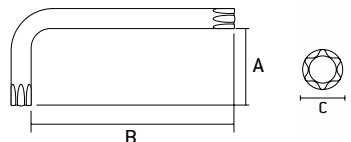

Jogos de Chaves Torx de 9 peças

Torx key set - 9 peices | Juegos de Chaves Torx de 9 piezas



9
peças
parts | piezas

SKU	CHAVE CORRESPONDENTE	KG	A	B
123059	T10 T15 T20 T25 T27 T30 T40 T45 T50 - curta	48	12	12
123069	T10 T15 T20 T25 T27 T30 T40 T45 T50 - longa	36	12	12
123079	TR T10 T15 T20 T25 T27 T30 T40 T45 T50 - extra longa	36	12	12

123059 - Curta

CHAVE CORRESPONDENTE	KG	A	B
T10	1g	13	44
T15	2g	15	48
T20	4g	18	56
T25	5g	20	63
T27	10g	24	70
T30	18g	27	80
T40	28g	31	90
T45	58g	35	100
T50	102g	40	112

123069 - Longa

CHAVE CORRESPONDENTE	KG	A	B
T10	1,4g	13	63
T15	2g	15	77
T20	4g	18	87
T25	7g	20	93
T27	14g	24	104
T30	25g	27	120
T40	41g	31	141
T45	84g	35	158
T50	145g	40	180

123079 - Extra Longa

CHAVE CORRESPONDENTE	KG	A	B
T10	1,6g	13	91
T15	3,2g	15	102
T20	5,6g	18	114
T25	9,1g	20	129
T27	18,2g	24	144
T30	32,5g	27	165
T40	53,2g	31	188
T45	104,9g	35	208
T50	183,6g	40	234

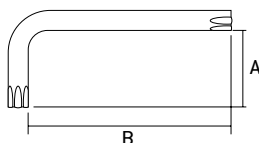

• Acabamento acetinado | Satin finish | Acabado satinado

Jogo de Chaves Allen de 9 peças fosfatizado

Allen Key Set - 9 peices Phosphatized | Juego de Chaves Allen de 9 piezas fosfatizado



112269

• Série curta | Short serie | Serie corta

CHAVE CORRESPONDENTE	KG	A	B
1,5	1g	13	44
2	2g	15	48
2,5	4g	18	56
3	5g	20	63
4	10g	24	70
5	18g	27	80
6	28g	31	90
8	58g	35	100
10	102g	40	112

9
peças
parts | piezas



SKU	CHAVE CORRESPONDENTE	KG	A	B
112269	1,5 2,0 2,5 3,0 4,0 5,0 6,0 8,0 10,0 mm - Curta	72	12	12
112319	1,5 2,0 2,5 3,0 4,0 5,0 6,0 8,0 10,0 mm - Longa	36	12	6



112319

• Série longa | Long serie | Serie Larga

CHAVE CORRESPONDENTE	KG	A	B
1,5	1,4 g	15	63
2	2 g	18	77
2,5	4 g	20	87
3	7 g	23	93
4	14 g	29	104
5	25 g	33	120
6	41 g	38	141
8	84 g	44	158
10	145 g	50	180

• Acabamento Fosfatizado | Phosphated Finish | Acabado Fosfatizado

Jogos de Chaves Allen de 9 peças Torx key set - 9 peices | Juegos de Chaves Torx de 9 piezas



Barcode	Dimensions	Box Qty	Min. Qty
112339	1,5 2,0 2,5 3,0 4,0 5,0 6,0 8,0 10,0 mm - Longa	36	6
164109	1,5 2,0 2,5 3,0 4,0 5,0 6,0 8,0 10,0 mm - Extra-longa	36	12
164119	2,0 2,5 3,0 4,0 5,0 6,0 8,0 10,0 12,0 mm - Extra-longa	36	12



BLISTER



9 peças
parts | piezas

112339 • Série longa | Long serie | Serie larga

CHAVE CORRESPONDENTE CORRESPONDING KEY CLAVE CORRESPONDENTE	KG	DIMENSÕES SIZE TAMAÑO (MM)	
		A	B
1.5	1 g	13	63
2	2 g	15	77
2.5	4 g	18	87
3	5 g	20	93
4	10 g	24	104
5	18 g	27	120
6	28 g	31	141
8	102 g	35	158
10	120 g	40	180



Permite trabalhar com um ângulo de até 25° em relação ao eixo do parafuso.

This key allows you to work on screws situated up to 25° from the vertical.

Permite trabajar con un ángulo de hasta 25° con relación al eje del tornillo.



9 peças
parts | piezas

164109 • Série extra longa | Extra long serie Serie extra larga

CHAVE CORRESPONDENTE CORRESPONDING KEY CLAVE CORRESPONDENTE	KG	DIMENSÕES SIZE TAMAÑO (MM)	
		A	B
1,5	1,6 g	15	91
2,0	3,2 g	18	102
2,5	5,6 g	20	114
3,0	9,1 g	23	129
4,0	18,2 g	29	144
5,0	32,5 g	33	165
6,0	53,2 g	38	188
8,0	104,9 g	44	208
10,0	183,6 g	50	234

164119 • Série extra longa | Extra long serie Serie extra larga

CHAVE CORRESPONDENTE CORRESPONDING KEY CLAVE CORRESPONDENTE	KG	DIMENSÕES SIZE TAMAÑO (MM)	
		A	B
2,0	3,2 g	18	102
2,5	5,6 g	20	114
3,0	9,1 g	23	129
4,0	18,2 g	29	144
5,0	32,5 g	33	165
6,0	53,2 g	38	188
8,0	104,9 g	44	208
10,0	183,6 g	50	234
12,0	260 g	55	259

• Acabamento acetinado | Satin Finish | Acabado santinado

Jogo de Chaves Allen de 9 peças acetinado

Satin Allen key set - 9 peices | Juego de Chaves Allen de 9 piezas satinado



CrV
Alta
Qualidade



BLISTER



9
peças
parts | piezas

123019

• Série curta | Short series | Serie corta

CHAVE CORRESPONDENTE CORRESPONDING KEY CLAVE CORRESPONDENTE	KG	DIMENSÕES SIZE TAMAÑO (MM)	
		A	B
2,0	2g	15	48
2,5	4g	18	56
3,0	5g	20	63
4,0	10g	24	70
5,0	18g	27	80
6,0	28g	31	90
8,0	58g	35	100
10,0	102g	40	112
12,0	120g	45	120

123039

• Série curta | Short series | Serie corta

CHAVE CORRESPONDENTE CORRESPONDING KEY CLAVE CORRESPONDENTE	KG	DIMENSÕES SIZE TAMAÑO (MM)	
		A	B
1,5	1g	13	44
2,0	2g	15	48
2,5	4g	18	56
3,0	5g	20	63
4,0	10g	24	70
5,0	18g	27	80
6,0	28g	31	90
8,0	58g	35	100
10,0	102g	40	112



9
peças
parts | piezas

123049

• Série longa | Long serie | Serie larga

CHAVE CORRESPONDENTE CORRESPONDING KEY CLAVE CORRESPONDENTE	KG	DIMENSÕES SIZE TAMAÑO (MM)	
		A	B
1,5	1,4g	13	63
2,0	2g	15	77
2,5	4g	18	87
3,0	7g	20	93
4,0	14g	24	104
5,0	25g	27	120
6,0	41g	31	141
8,0	84g	35	158
10,0	145g	40	180

123029

• Série longa | Long serie | Serie larga

CHAVE CORRESPONDENTE CORRESPONDING KEY CLAVE CORRESPONDENTE	KG	DIMENSÕES SIZE TAMAÑO (MM)	
		A	B
2,0	2g	15	77
2,5	4g	18	87
3,0	7g	20	93
4,0	14g	24	104
5,0	25g	27	120
6,0	41g	31	141
8,0	84g	35	158
10,0	145g	40	180
12,0	228g	55	205

• Acabamento acetinado | Satin Finish | Acabado santinado



9
peças
parts | piezas

164099
• Série extra longa | Extra long serie |
Serie extra larga

CHAVE CORRESPONDENTE CORRESPONDING KEY CLAVE CORRESPONDENTE	KG	DIMENSÕES SIZE TAMAÑO (MM)	
		A	B
1,5	1,6g	13	91
2,0	3,2g	15	102
2,5	5,6g	18	114
3,0	9,1g	20	129
4,0	18,2g	24	144
5,0	32,5g	27	165
6,0	53,2g	31	188
8,0	104,9g	35	208
10,0	183,6g	40	234

123089
• Série extra longa | Extra long serie |
Serie extra larga

CHAVE CORRESPONDENTE CORRESPONDING KEY CLAVE CORRESPONDENTE	KG	DIMENSÕES SIZE TAMAÑO (MM)	
		A	B
2,0	3,2g	15	102
2,5	5,6g	18	114
3,0	9,1g	20	129
4,0	18,2g	24	144
5,0	32,5g	27	165
6,0	53,2g	31	188
8,0	104,9g	35	208
10,0	183,6g	40	234
12,0	260g	55	259

Jogos de Chaves Allen / Torx Argola

Allen / Torx key set Ring | Juegos de Llaves Allen / Torx Anillo

- HEX
- TR
- SACO PLÁSTICO
- AUTO SERVIÇO



NOVO							
1126655	1,5 2,0 2,5 3,0 3,5 4,0 5,0 6,0 8,0 10,0 mm - HEX	100	20				
1126675	T10 T15 T20 T25 T27 T30 T40 T45 T50 - TORX	100	20				

112665 / 1126655

• Série curta | Shoet serie | Serie corte

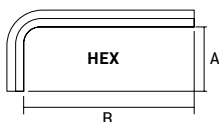

10
peças
parts | piezas

CHAVE CORRESPONDENTE CORRESPONDING KEY CLAVE CORRESPONDENTE	KG	DIMENSÕES SIZE TAMAÑO (MM)	
		A	B
1,5	1g	12	37
2	2g	13	40
2,5	3g	14	42
3	4g	14	47
3,5	6g	15	48
4	8g	16	53
5	12g	17	57
6	20g	18	60
8	38g	19	62
10	68g	23	72

112667 / 1126675

• Série curta | Shoet serie | Serie corte

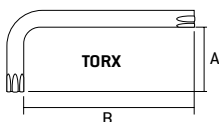

9
peças
parts | piezas

CHAVE CORRESPONDENTE CORRESPONDING KEY CLAVE CORRESPONDENTE	KG	DIMENSÕES SIZE TAMAÑO (MM)	
		A	B
T10	1g	13	44
T15	2g	15	48
T20	4g	18	56
T25	5g	20	63
T27	10g	24	70
T30	18g	27	80
T40	28g	31	90
T45	58g	35	100
T50	102g	40	112

•Acabamento Fosfatizado | Phosphated Finish | Acabado Fosfatizado

Estojo de Chaves Allen HEX/Torx de 18 peças

Allen HEX/Torx key case - 18 peices | Estuche de Llaves Allen HEX/Torx de 18 piezas



18
peças
parts | piezas



123149	1,5 2,0 3,0 4,0 5,0 6,0 8,0 10,0 12,0 mm TH1,5 2,0 2,5 3,0 4,0 5,0 6,0 8,0 10,0 12,0 mm T10 T15 T20 T25 T27 T30 T40 T45 T50 - CURTA	48	12
123159	1,5 2,0 2,5 3,0 4,0 5,0 6,0 8,0 10,0 mm T10 T15 T20 T25 T27 T30 T40 T45 T50 - LONGA	36	12

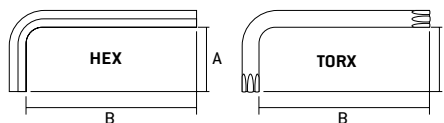

123149

CHAVE CORRESPONDENTE CORRESPONDING KEY CLAVE CORRESPONDENTE	KG	DIMENSÕES SIZE TAMAÑO (MM)	
		A	B
1,5	1g	12	37
2	2g	13	40
2,5	3g	14	42
3	4g	14	47
3,5	6g	15	48
4	8g	16	53
5	12g	17	57
6	20g	18	60
8	38g	19	62
10	68g	23	72
T10	1g	13	44
T15	2g	15	48
T20	4g	18	56
T25	5g	20	63
T27	10g	24	70
T30	18g	27	80
T40	28g	31	90
T45	58g	35	100
T50	102g	40	112

123159

CHAVE CORRESPONDENTE CORRESPONDING KEY CLAVE CORRESPONDENTE	KG	DIMENSÕES SIZE TAMAÑO (MM)	
		A	B
1,5	1,4 g	15	63
2	2 g	18	77
2,5	4 g	20	87
3	7 g	23	93
4	14 g	29	104
5	25 g	33	120
6	41 g	38	141
8	84 g	44	158
10	145 g	50	180
T10	6,2 g	23	93
T15	9 g	25	98
T20	12,5 g	29	104
T25	17,2 g	30	114
T27	22,4 g	33	120
T30	31,8 g	38	141
T40	53,6 g	41	147
T45	75 g	44	158
T50	101 g	47	169

- Acabamento acetinado | Satin Finish | Acabado santinado
- Estojo em tecido | Fabric case | Estuche de tela

Estojo de Chaves Allen de 10 peças

Allen key case - 10 peices | Estuche de llaves Allen 10 piezas



10
peças
parts | piezas



123099	1,5 2,0 2,5 3,0 4,0 5,0 6,0 8,0 10,0 12,0 mm - Curtas	48	12
123109	1,5 2,0 2,5 3,0 4,0 5,0 6,0 8,0 10,0 12,0 mm - Extra Longa	36	12



123109

CHAVE CORRESPONDENTE CORRESPONDING KEY CLAVE CORRESPONDENTE	KG	DIMENSÕES SIZE TAMAÑO (MM)	
		A	B
1,5	1,6g	13	91
2,0	3,2g	15	102
2,5	5,6g	18	114
3,0	9,1g	20	129
4,0	18,2g	24	144
5,0	32,5g	27	165
6,0	53,2g	31	188
8,0	104,9g	35	208
10,0	183,6g	40	234
12,0	260 g	55	259

123099

CHAVE CORRESPONDENTE CORRESPONDING KEY CLAVE CORRESPONDENTE	KG	DIMENSÕES SIZE TAMAÑO (MM)	
		A	B
1,5	1g	13	44
2	2g	15	48
2,5	4g	18	56
3	5g	20	63
4	10g	24	70
5	18g	27	80
6	28g	31	90
8	58g	35	100
10	102g	40	112
12	167 g	50	137

- Acabamento acetinado | Satin Finish | Acabado santinado

Estojo de Chaves Allen de 10 peças abaulada

Allen key case - 10 peices Round edge | Estuche de llaves Allen 10piezas Punta Redonda



10
peças
parts | piezas



123119



1,5 | 2,0 | 2,5 | 3,0 | 4,0 | 5,0 | 6,0 | 8,0 | 10,0 mm - Extra Longa



36



12



CHAVE CORRESPONDENTE CORRESPONDING KEY CLAVE CORRESPONDENTE	KG	DIMENSÕES SIZE	TAMANHO (MM)
		A	B
1,5	1,6g	13	91
2,0	3,2g	15	102
2,5	5,6g	18	114
3,0	9,1g	20	129
4,0	18,2g	24	144
5,0	32,5g	27	165
6,0	53,2g	31	188
8,0	104,9g	35	208
10,0	183,6g	40	234
12,0	260g	55	259

Permite trabalhar com um ângulo de até 25° em relação ao eixo do parafuso.

This key allows you to work on screws situated up to 25° from the vertical.

Permite trabajar con un ángulo de hasta 25° con relación al eje del tornillo.



- Acabamento acetinado | Satin Finish | Acabado santinado
- Ponta Abaulada | Round edge | Punta Redonda

Estojo de Chaves Torx de 9 peças

Torx key case - 9 peices | Estuche de Chaves Torx de 9 piezas



9
peças
parts | piezas



123129



T10 | T15 | T20 | T25 | T27 | T30 | T40 | T45 | T50 - curta



48



12



123139



T10 | T15 | T20 | T25 | T27 | T30 | T40 | T45 | T50 - longa



36



12



123129

CHAVE CORRESPONDENTE CORRESPONDING KEY CLAVE CORRESPONDENTE	KG	DIMENSÕES SIZE	TAMANHO (MM)
		A	B
T10	1g	13	44
T15	2g	15	48
T20	4g	18	56
T25	5g	20	63
T27	10g	24	70
T30	18g	27	80
T40	28g	31	90
T45	58g	35	100
T50	102g	40	112

123139

CHAVE CORRESPONDENTE CORRESPONDING KEY CLAVE CORRESPONDENTE	KG	DIMENSÕES SIZE	TAMANHO (MM)
		A	B
T10	1,4g	13	63
T15	2g	15	77
T20	4g	18	87
T25	7g	20	93
T27	14g	24	104
T30	25g	27	120
T40	41g	31	141
T45	84g	35	158
T50	145g	40	180

- Acabamento acetinado | Satin Finish | Acabado santinado
- Com furo | With hole | Con agujero

Linha de Bits Ponta Fenda 5 Peças

Fenda Point Bits Line 5 Pieces | Línea de Bits Puntera Fenda 5 Piezas



Barcode	SKU	DIMENSÕES SIZE TAMAÑO (MM)		Box	Quant. Min.
		A	B		
1134055	SL3,5 x 25 mm	3,5	25	200	25
1134155	SL4,0 x 25 mm	4,0	25	200	25
1134255	SL4,5 x 25 mm	4,5	25	200	25
1134355	SL5,0 x 25 mm	5,0	25	200	25
1134455	SL6,0 x 25 mm	6,0	25	200	25
1134655	SL4,0 x 38 mm	4,0	38	200	25
1134755	SL4,5 x 38 mm	4,5	38	200	25
1134855	SL5,0 x 38 mm	5,0	38	200	25
1134955	SL6,0 x 38 mm	6,5	38	200	25
1135255	SL3,5 x 50 mm	3,5	50	200	25
1135355	SL4,0 x 50 mm	4,0	50	200	25
1135455	SL4,5 x 50 mm	4,5	50	200	25
1135555	SL6,0 x 50 mm	6,0	50	200	25
1135755	SL3,5 x 75 mm	3,5	75	100	25
1135855	SL4,0 x 75 mm	4,0	75	200	25
1135955	SL6,0 x 75 mm	6,0	75	200	25



• Encaixe Sextavado 1/4" | Hex socket 1/4 " | Encaje Sexto 1/4 "

Linha de Bits Ponta Phillips 5 Peças

Phillips Point Bits Line 5 Pieces | Línea de Bits Puntera Phillips 5 Piezas



Barcode	SKU	DIMENSÕES SIZE TAMAÑO (MM)		Box	Quant. Min.
		A	B		
1136155	PH1 - 4,0x25 mm	4	25	200	25
1136255	PH2 - 5,0x25 mm	5	25	200	25
1136355	PH3 - 6,0x25 mm	6	25	200	25
1136455	PH1 - 4,0x38 mm	4	38	200	25
1136555	PH2 - 5,0x38 mm	5	38	200	25
1136655	PH3 - 6,0x38 mm	6	38	200	25
1136755	PH1 - 4,0x50 mm	4	50	200	25
1136855	PH2 - 5,0x50 mm	5	50	200	25
1136955	PH3 - 6,0x50 mm	6	50	200	25
1137055	PH1 - 4,0x75 mm	4	75	200	25



• Encaixe Sextavado 1/4" | Hex socket 1/4 " | Encaje Sexto 1/4 "

Linha de Bits Industrial TORX Cromo Molibdênio 5 Peças

Industrial Bit Series Chrome Molybdenum 5 Pieces |

Línea de Bits Industrial Cromo Molibdeno 5 Piezas



Barcode	Part No.	DIMENSÕES SIZE TAMAÑO (MM)		Box	Quant. Min.
		A	B		
1130155	T6 x 25 mm	T6	25	200	25
1130255	T7 x 25 mm	T7	25	200	25
1130355	T8 x 25 mm	T8	25	200	25
1130455	T9 x 25 mm	T9	25	200	25
1130555	T10 x 25 mm	T10	25	200	25
1130655	T15 x 25 mm	T15	25	200	25
1130755	T20 x 25 mm	T20	25	200	25
1130855	T25 x 25 mm	T25	25	200	25
1130955	T27 x 25 mm	T27	25	200	25
1131055	T30 x 25 mm	T30	25	200	25
1131155	T40 x 25 mm	T40	25	200	25
1131255	T6 x 50 mm	T6	50	200	25
1131355	T7 x 50 mm	T7	50	200	25
1131455	T8 x 50 mm	T8	50	200	25
1131555	T9 x 50 mm	T9	50	200	25
1131655	T10 x 50 mm	T10	50	200	25
1131755	T15 x 50 mm	T15	50	200	25
1131855	T20 x 50 mm	T20	50	200	25
1131955	T25 x 50 mm	T25	50	200	25
1132055	T27 x 50 mm	T27	50	200	25
1132155	T30 x 50 mm	T30	50	200	25
1132255	T40 x 50 mm	T40	50	200	25
1132355	T6 x 75 mm	T6	75	100	25
1132455	T7 x 75 mm	T7	75	100	25
1132555	T8 x 75 mm	T8	75	100	25
1132655	T9 x 75 mm	T9	75	100	25
1132755	T10 x 75 mm	T10	75	100	25
1132855	T15 x 75 mm	T15	75	100	25
1132955	T20 x 75 mm	T20	75	100	25
1133055	T25 x 75 mm	T25	75	100	25
1133155	T27 x 75 mm	T27	75	100	25
1133255	T30 x 75 mm	T30	75	100	25



• Encaixe Sextavado 1/4" | Hex socket 1/4 " | Encaje Sexto 1/4 "



BITS COM LIMITADOR

BITS WITH LIMITATOR | BITS CON LIMITADOR

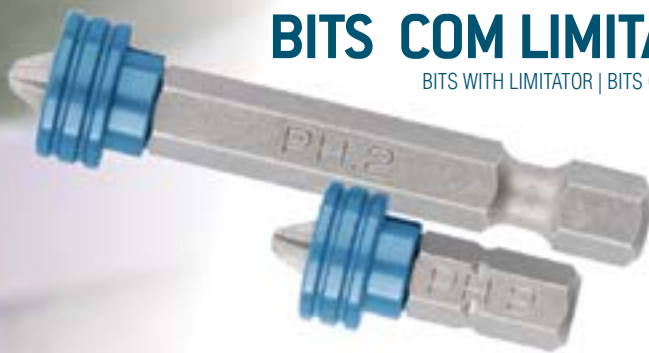

Encaixe Sextavado 1/4" | Hex socket 1/4 " | Encaje Sexto 1/4 " •
Imantado e com limitador | Magnetized and with limite | Magnetizado y con limitador •
Tamanho: 25mm|50mm | Size: 25mm|50mm | Tamaño: 25mm|50mm •

Aplicação para parede Gesso /Drywall | Wall application Plaster / Drywall | Aplicación para pared Yeso / Drywall •

Conjunto de bits de dois lados PH2 45mm 10 pçs

Double Sided Bits 45mm | Conjunto de bits de dos lados 45mm

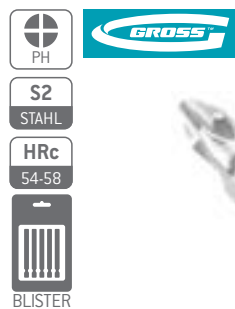

10 peças
parts | piezas

1120955	(PH 2)1/4"	DIMENSÕES SIZE TAMAÑO (MM)		50	Quant. Min.
		A	B		

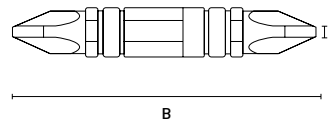

- Aço CrMo | Stel CrMo | Acero CrMo
- Encaixe Sextavado 1/4" | Hex socket 1/4" | Encaje Sexto 1/4"
- Ponta Dupla Imantada | Magnet Double Tip | Punta Doble Magnetizada
- Tamanho: 45mm | Size: 45mm | Tamaño: 45mm

Ranuras para maior aderência
Grooves for added grip
Ranuras para una mayor adherencia



Conjunto de bits PH2 70 mm 10 pçs

Set of 70 mm bits | Conjunto de bits 70 mm

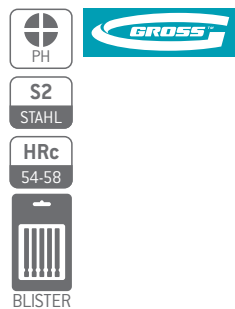

10 peças
parts | piezas

1126256	(PH 2)1/4"	DIMENSÕES SIZE TAMAÑO (MM)		50	10
		A	B		



- Ponta Imantada | Magnet Tip | Punta Magnetizada
- Aço CrMo | Stel CrMo | Acero CrMo
- Encaixe Sextavado 1/4" | Hex socket 1/4" | Encaje Sexto 1/4"
- Tamanho: 70mm | Size: 70mm | Tamaño: 70mm

Ranuras para maior aderência
Grooves for added grip
Ranuras para una mayor adherencia



Conjunto de bits PH2 90mm - 10pçs

Set of 90mm bits 10pcs | Conjunto de bits 90mm 10pzs

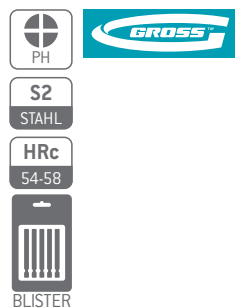

10 peças
parts | piezas

1126356	(PH 2)1/4"	DIMENSÕES SIZE TAMAÑO (MM)		50	10
		A	B		

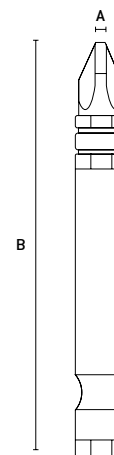

- Ponta Imantada | Magnet Tip | Punta Magnetizada
- Aço CrMo | Stel CrMo | Acero CrMo
- Encaixe Sextavado 1/4" | Hex socket 1/4" | Encaje Sexto 1/4"
- Tamanho: 70mm | Size: 70mm | Tamaño: 70mm

Conjunto de bits 25mm - 10 pçs

Set of 25mm bits - 10 pcs | Conjunto de bits 25mm - 10 pcs



antigo	novo		DIMENSÕES SIZE TAMAÑO (MM)			Quant. Min.
			A	B		
11330	1132956	(PH 1) 3/16"	4,763	25	60	20
	1133056	(PH 2) 1/4"	6,35	25	60	20

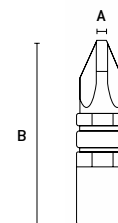

- Ponta Imantada | Magnet Tip | Punta Magnetizada
- Aço CrMo | Stéll CrMo | Acero CrMo
- Encaixe Sextavado 1/4" | Hex socket 1/4 " | Encaje Sexto 1/4 "
- Tamanho: 25mm | Size: 25mm | Tamaño: 25mm

Conjunto de bits PH2 25 mm 2 pçs

Set of 25 mm bits | Conjunto de bits 25 mm

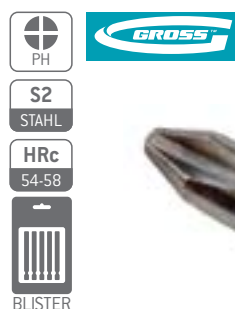

antigo	novo		DIMENSÕES SIZE TAMAÑO (MM)			Quant. Min.
			A	B		
11349	1134956	(PH 1) 3/16"	4,763	25	60	20
11351	1135156	(PH 2) 1/4"	6,35	25	60	20

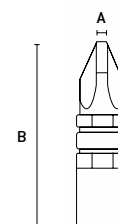

- Ponta Imantada | Magnet Tip | Punta Magnetizada
- Aço CrMo | Stéll CrMo | Acero CrMo
- Encaixe Sextavado 1/4" | Hex socket 1/4 " | Encaje Sexto 1/4 "
- Tamanho: 70mm | Size: 70mm | Tamaño: 70mm

Conjunto de bits 50/70/90mm 10 pçs

Bit set 50/70/90mm | Conjunto de bits 50/70/90mm

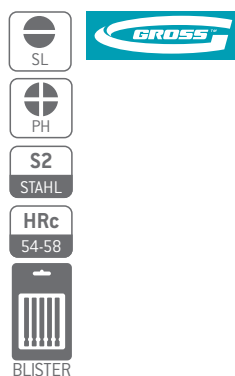

antigo	novo		DIMENSÕES SIZE TAMAÑO ()			Quant. Min.
			A	B		
11325	1132556	(SL 5) 7/32"	5,55	50	60	20
	1132656	(SL 6) 1/4"	6,35	50	60	20
	1133455	(PH 1) 3/16"	4,736	50	60	20
	1133555	(PH 2) 1/4"	6,35	50	60	20
	1133655	(PH 3) 5/16"	7,938	50	60	20
	1137855	(PH 2) 1/4"	4,763	70	60	20
	1137955	(PH 2) 1/4"	6,35	90	60	20

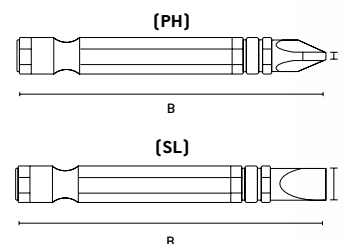

- Encaixe Sextavado 1/4" | Hex socket 1/4 " | Encaje Sexto 1/4 "

Conjunto de bits adaptador magnético 50mm 2 pçs

Magnetic adapter bit set 50mm | Conjunto de bits magnético 50mm

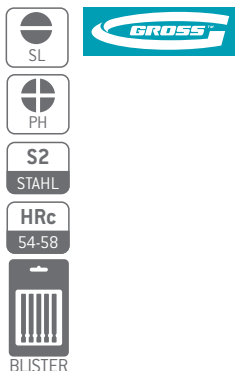

2 peças
parts / piezas

antigo	novo	[]	DIMENSÕES SIZE TAMAÑO (MM)		Quant. Min.
			A	B	
11355	1135556	[PH1] 3/16"	4,763mm	50mm	60 20
	1135756	[PH2] 1/4"	6,35mm	50mm	60 20
11359	1135956	[PH3] 5/16"	7,938mm	50mm	60 20
	1137655	[SL5] 1/4"	6,35mm	50mm	60 20

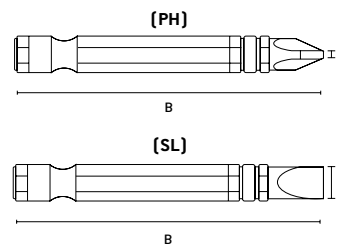

- Ponta Imantada | Magnet Tip | Punta Magnetizada
- Encaixe Sextavado 1/4" | Hex socket 1/4 " | Encaje Sexto 1/4 "
- Tamanho: 50mm | Size: 50mm | Tamaño: 50mm

Conjunto de bits com limitador

Bit set with limiter | Conjunto de bits con limitador

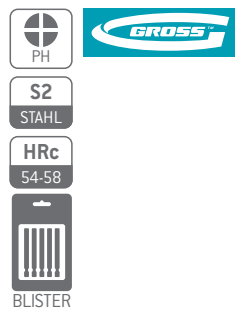

antigo	novo	[]	DIMENSÕES SIZE TAMAÑO (MM)		Quant. Min.
			A	B	
11455	1145556	[PH2] 1/4"	6,35mm	25mm	60 10
11456	1145656	[PH2] 1/4"	6,35mm	50mm	60 10

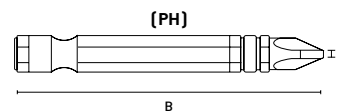

- Encaixe Sextavado 1/4" | Hex socket 1/4 " | Encaje Sexto 1/4 "
- Imantado e com limitador | Magnetized and with limite | Magnetizado y con limitador
- Tamanho: 25mm|50mm | Size: 25mm|50mm | Tamaño: 25mm|50mm
- Aplicação para parede Gesso /Drywall | Wall application Plaster / Drywall | Aplicación para pared Yeso / Drywall

Jogo de Bits/Ponteiras 7pçs

Bits / Tips Set 7pc | Juego de Bits / Puntas 7pc



7 peças
parts / piezas



113929	SL, PH, PZ	120	10
--------	------------	-----	----

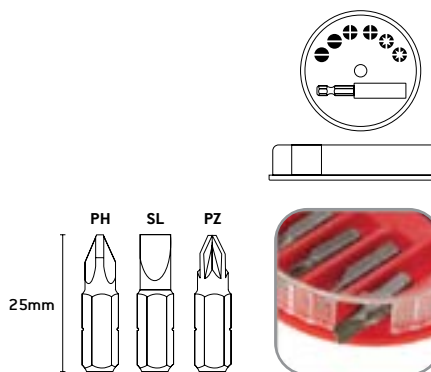

- Adaptador Magnético | Magnetic Adapter | Adaptador magnético
- Bits Tamanho: 25mm | Bits Size: 25mm | Bits Tamaño: 25mm

Composição | Composition | composición:

- 1 adaptador magnético | magnetic adapter | adaptador magnético para bits
- 6 pçs
- bits: PH1/PH2/PZ1/PZ2/SL5/SL7

Maleta Conjunto de bits e cabeças 26 pçs
 Case Set of bits and heads 26 pcs | Maleta Conjunto de bits y cabezas 26 pçs



			DIMENSÕES SIZE TAMAÑO (MM)	
1136156	SL/PH/PZ/TR/HEX	450g	A: 133 B: 194	30 15

26
peças
parts | piezas

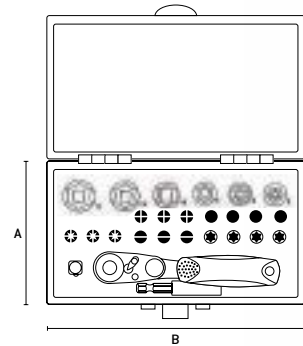

- Aço CrMo | Steel CrMo | Acero CrMo
- Adaptador Magnético | Magnetic Adapter | Adaptador magnético
- Catraca reversível | Reversible ratchet | Catraca reversible
- Encaixe 1/4" | 1/4 "socket | Enchufe 1/4 "
- Bits Tamanho: 25mm | Bits Size: 25mm | Bits Tamaño: 25mm

Composição | Composition | composición:

- 1 adaptador Quadrado | 1 Square adapter 25mm
- 1 Chave de catraca 52 dentes | Ratchet wrench 52 teeth | Llave de trinquete 52 dientes
- 17 bits PH1/PH2/PH3/PZ1/PZ2/PZ3
 TORX: T10, T15, T20, T25, T27, T30, T40
 HEX 3/4/5/6mm
- 6 Soquetes | Sockets de 1/4" 5/6/8/10/12/13mm

Maleta Conjunto de bits e cabeças 33 pçs
 Case Set of bits and heads 33 pcs | Maleta Conjunto de bits y cabezas 33 pçs



			DIMENSÕES SIZE TAMAÑO (MM)	
1136556	SL, PH, TR, HEX, TT, PZ	417g	A: 133 B: 194	30 15

33
peças
parts | piezas

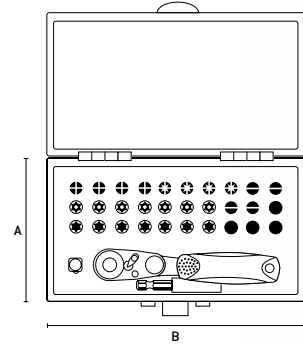

- Adaptador Magnético | Magnetic Adapter | Adaptador magnético
- Catraca reversível | Reversible ratchet | Catraca reversible
- Encaixe 1/4" | 1/4 "socket | Enchufe 1/4 "
- Bits Tamanho: 25mm | Bits Size: 25mm | Bits Tamaño: 25mm

Composição | Composition | composición:

- 1 adaptador Quadrado | 1 Square adapter 25mm
- 1 adaptador magnético | adapter magnetic
- 1 Chave de catraca 52 dentes | Ratchet wrench 52 teeth | Llave de trinquete 52 dientes
- 30 bits PH1, PH2, PH3, PZ1, PZ2, PZ3
 TORX: T10, T15, T20, T25, T27, T30, T40
 TORX com guia: T10, T15, T20, T25, T27, T30, T40
 H3, H4, H5, H6 / SL3, SL4, SL5, SL6

Maleta Conjunto de bits e cabeças 61 pçs
 Case Set of bits and heads 61 pcs | Maleta Conjunto de bits y cabezas 61 pçs



			DIMENSÕES SIZE TAMAÑO (MM)	
113879	SL, PH, TR, SPAN, HEX, TT, PZ soquetes, SP	469g	A: 89 B: 127	36 12

61
peças
parts | piezas

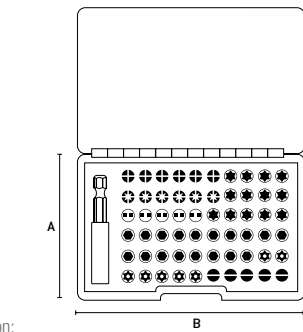

- Aço CrV | Steel CrV | Acero CrV
- Adaptador Magnético - IMÁ MINEDIN | MINEDIN Magnetic Adapter | Adaptador magnético - MINEDIN
- Encaixe 1/4" | 1/4 "socket | Enchufe 1/4 "
- Bits Tamanho: 25mm | Bits Size: 25mm | Bits Tamaño: 25mm

Composição | Composition | composición:

- 1 adaptador magnético | magnetic adapter | adaptador magnético para bits
- 60 bits
 # 5 Fenda: 3, 4, 5, 6 e 7 mm
 # 7 Torx com guia: T10, T15, T20, T25, T27, T30 e T35
 # 6 Allen com guia: 2, 2.5, 3, 4, 5 e 6 mm
 # 12 Allen: 1.5, 2, 2.5, 3, 3.5, 4, 4.5, 5, 5.5, 6, 7 e 8 mm
 # 9 Torx: T9, T10, T15, T20, T25, T27, T30, T35 e T40
 # 5 Spanner: (2) 4, 6, 8 e 10 / # 6 Pozidriv: P20, PZ1, (3) PZ2 e PZ3
 # 6 Phillips: PH0, PH1, (3) PH2 e PH3

**Maleta Conjunto de Bits/
Ponteiras e Brocas 40pçs**

Bits / Tips and Drills Set 40pcs |
Maleta Conjunto de Bits / Pontas y Brocas 40pçs



- Aço CrV | Stel CrV | Acero CrV
- Adaptador Magnético | Magnetic Adapter | Adaptador magnético
- Bits Tamanho: 25mm | Bits Size: 25mm | Bits Tamaño: 25mm

113229	SL, PH, PZ, TR, brocas drills	742g	DIMENSÕES SIZE TAMAÑO (MM)			12	Quant. Min.
			A	B	C		
			226	257			

40
peças
parts | piezas

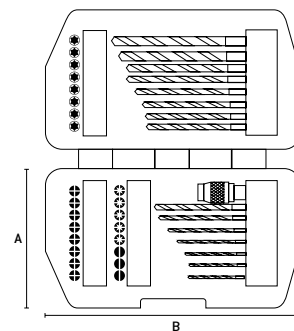

Composição | Composition | composición:

- 1 adaptador magnético | magnetic adapter | adaptador magnético para bits
- 24pçs bits: PH0/ PH1/PH2/PH3 PZ0/PZ1/PZ2/PZ3 T8/T10/T15/T20/T25/T27/T30/ T40 SL4/ SL5/ SL6/ SL7/ SL8mm broca: 1/1,5/2/2,5/3/3,2/3,5/4/4,5/4,8/5/5,5/6mm

Jogo de Bits/Ponteiras 18pçs

Bits / Tips Set 18pcs | Juego de Bits / Pontas 18pçs



113839	SL, PH, TR, SPAN, HEX, TT, PZ soquetes, SP	256g	DIMENSÕES SIZE TAMAÑO (MM)			48	12
			A	B	C		
			178	198	39		

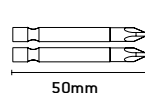

18
peças
parts | piezas

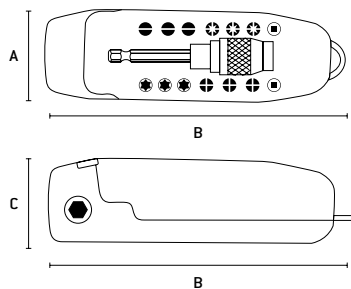

Encaixe Lateral
Lateral Attachment
Encaje Lateral



Composição | Composition | composición:

- 1 adaptador 65mm | adapter | adaptador
- 1 Carabiner
- 14 bits 25mm: PH1/PH2/PH3/PZ1/PZ2/PZ3 SL3/SL4/SL5/T10/T15/T25/S1/S2
- 2 bits 50mm: PZ1/PZ2

Bits / Ponteira - 1/4"

Bits / Tips - 1/4" | Bits / Ponteira - 1/4"



- Adaptador Magnético | Magnetic Adapter | Adaptador magnético
- Encaixe 1/4" | Fitting 1/4 " | Encaje 1/4



113989	207g	DIMENSÕES SIZE TAMAÑO (MM)			100	0
		A	B	C		
117929	20g	52	110	11	200	10

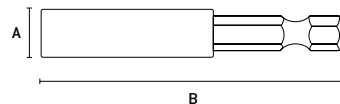

113989
• 10 peça | piece | pieza

117929
• 1 peça | piece | pieza

Soquetes Magnéticos - 2 pçs

Magnetic Sockets | Soportes Magnéticos



- Encaixe 1/4" | Fitting 1/4" | Encaje 1/4"
- Embalagem com 2 peças | Packing with 2 pieces | Embalaje con 2 piezas



Código	Qtd	DIMENSÕES SIZE TAMAÑO (MM)		Cubo	Quant. Min.
		Ø	B		
115669	2pçs	6mm	45mm	480	20
115689	2pçs	7mm	45mm	480	20
115699	2pçs	8mm	45mm	480	20
115719	2pçs	10mm	45mm	480	20
115739	2pçs	8mm	65mm	300	10
115769	2pçs	10mm	65mm	300	10
117889	2pçs	12mm	45mm	200	10
117899	2pçs	13mm	45mm	200	10
117909	2pçs	12mm	65mm	200	10
117919	2pçs	13mm	65mm	200	10

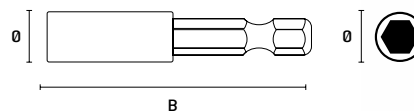

Pulseira Magnética

Magnetic Bracelet | Pulsera magnética



- Para pregos, pinos e parafuso | For nails, pins and bolts | Para clavos, pernos y tornillos



Código	KG	DIMENSÕES SIZE TAMAÑO (MM)			Cubo	Quant. Min.
		A	B	C		
115649	123g	53	310	29	100	20

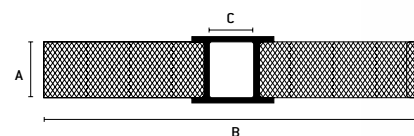

Chave de bits reversível com dobradiça - 18 pçs

Reversible bit key with hinged | Llave de bits reversible con bisagra



18 peças
parts | piezas

Código	SL, PH, TR, HEX, PZ	KG	DIMENSÕES SIZE TAMAÑO (MM)		Cubo	Quant. Min.
			A	B		
1155455		333g	35	265	48	24

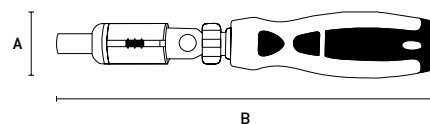

Composição | Composition | composición:

- 1 chave de bits e soquetes | 1 bit key and sockets | 1 clave de bits y sockets
- 1 adaptador para bits | 1 bit adapter | 1 adaptador para bits
- 10 bits 25mm: PH2/PH3/PZ2/PZ3/SL4/SL5/SL6/SL7/TR15/TR20
- 6 soquetes | sockets | enchufe : HEX 5/6/7/8/9/10

Chave de bits com catraca reversível - 14 pçs

Reversible ratchet bit key | Llave de bits con trinquete reversible



14 peças
parts | piezas

Código	SL, PH, HEX	KG	DIMENSÕES SIZE TAMAÑO (MM)			Cubo	Quant. Min.
			A	B			
1155655		278g	115	32	72	36	

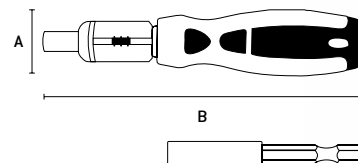

Composição | Composition | composición:

- 1 chave de bits e soquetes | 1 bit key and sockets | 1 clave de bits y sockets
- 1 adaptador para bits | 1 bit adapter | 1 adaptador para bits
- 6 bits 25mm: PH1/PH2/PH3/SL4/SL5/SL7
- 6 soquetes | sockets | enchufe : HEX 5/6/7/8/9/10

Chave reversível com bits/ponteira/soquetes-16pçs

Reversible switch with bits/bushing/sockets-16pcs | Llave reversible con bits/puntera/enchufe-16pzs



BLISTER



16 peças
parts | piezas

113329	SL, PH, HEX, PZ	340g	DIMENSÕES SIZE TAMAÑO (MM)				Quant. Min.
			A	B			12

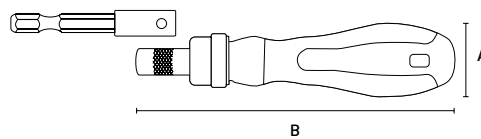

- Encaixe Sextavado 1/4" | Hex socket 1/4 " | Encaje Sexto 1/4 "
- Tamanho: 50mm | Size: 50mm | Tamaño: 50mm

Composição | Composition | composición:

- 1 chave de bits e soquetes | 1 bit key and sockets | 1 clave de bits y sockets
- 1 adaptador para soquetes | 1 socket adapter | 1 adaptador para sockets
- 1 extensor para soquetes | 1 socket extender | 1 extensor para sockets
- 9 bits 25mm: PH1/PH2/PH3/SL4/SL5/SL6/PZ1/PZ2/PZ3
- 4 soquetes | sockets | enchufe : HEX (1/4")5/6/10/11

Chave de bits com alça ergonômica em forma de T 12 pçs

Bit key with T-shaped ergonomic handle | Llave de bits con mango ergonómico en forma de T



BLISTER



12 peças
parts | piezas

115679	SL, PH, PZ	80g	DIMENSÕES SIZE TAMAÑO (MM)				Quant. Min.
			A	B	C		0

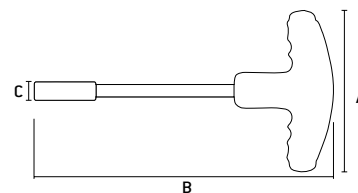

Composição | Composition | composición:

- 1 Cabo adaptador "T" | 1 Adapter cable | 1 cable adaptador
- 11 bits 25mm:
PH1/PH2/PH3
SL3/SL4/SL5/SL6/SL8
PZ1/PZ2/PZ3

Chave de Fenda/Phillips

Screwdriver / Phillips | Destornillador / phillips



BLISTER



antigo	novo			DIMENSÕES SIZE TAMAÑO (MM)				Quant. Min.	
115875	1158755	SL6/PH2 1/4"	47g	A	B	C	D		100

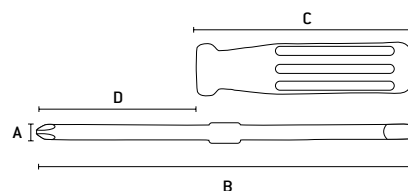

- Ponta Dupla | Double Tip | Punta Doble

Chave manual de impacto - 7 pçs

Rotary impact wrench - 7pcs | Llave de impacto rotativo - 7 pzs



			DIMENSÕES SIZE TAMAÑO [MM]				
115759	SL, PH	884g	A	B	C	25	0

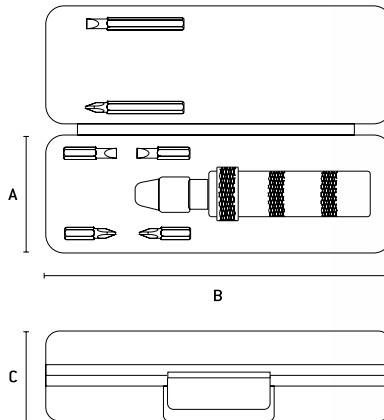

Composição | Composition | composición:
 • 1 chave de impacto | 1 key of impact | 1 clave de impacto
 • 6 bits : PH2 x 35mm / PH3 x 35mm / PH3 x 65mm
 SL2 X 35mm / SL8 X 35mm / SL8 X 65mm

Jogo de Ferramentas

Tool Set | Juego de herramientas



			DIMENSÕES SIZE TAMAÑO [MM]			
117859	SL, PH, TR, HEX, PZ	1,04Kg	A	B	12	6

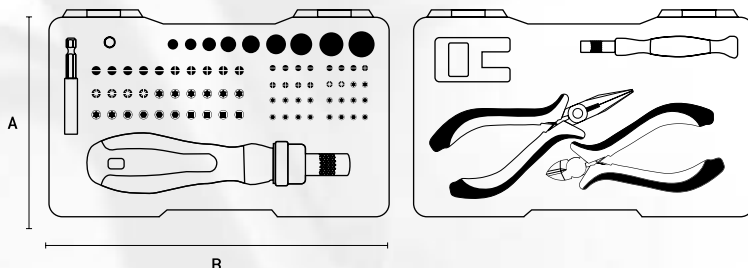

Composição | Composition | composición:

- 1 Chave de fenda reversível
Reversible screwdriver | Llave de ranura reversible
- 1 adaptador | adapter
- 1 suporte de bit | bit support | soporte de bits
- 1 chave de fenda para trabalho de precisão
Screwdriver for precision work | Destornillador para trabajo de precisión
- 1 alicate corte diagonal | diagonal cutting pliers
- 1 alicate de nariz longo | long nose pliers | alicate de nariz larga
- 1 magnetizador | magnetizer
- Bits para chave de fenda reversa:
Reverse Screwdriver Bits | Bits para destornillador inversa

T10, T15, T20 (2 pçs), T25 (2 pçs) T27, T30

SL3, SL4, SL5 (2 pçs) SL6

PH0, PH1, PH2 (2 pçs), PH3;

PZ0, PZ1, PZ2, PZ3

H3, H4, H5, H6

S0, S1, S2, S3;

• Bits de chave de fenda para trabalho de precisão:
Screwdriver bits for precision work | Bits de destornillador para trabajo de precisión

T4, T5, T6, T7, T8, T9, T10, T15, T20

SI1, S1.5, S2, S2.5, S3, S3.5, S4

PH000 (2 pçs), PH0, PH1;

Pz0, Pz1;

H0,7/H0,9/H1,3/H1,5/H2,5/H3,5/H4;

• Cabeça hexagonal para a chave de fenda reversa:
Hex Head for Reverse Screwdriver | Cabeza hexagonal para el destornillador inverso

5mm, 6mm, 7mm, 8mm, 9mm, 10mm, 11mm, 12mm, 13mm.



Caixa de bits /Ponteira Multidentada / adaptador 1/2" x 10 mm

Bit set Box Multidentate / Tip | Caja de bits / Puntera Multidentate



11 peças
parts | piezas

Composição | Composition | composición:

- 1 adaptador | adapter 1/2" x 10mm
- Bits 30mm: M5/M6/M8/M10/M12
- Bits 75mm: M5/M6/M8/M10/M12

1131256	Bits Spline	633g	DIMENSÕES SIZE TAMAÑO (MM)			30	0
			A	B	C		

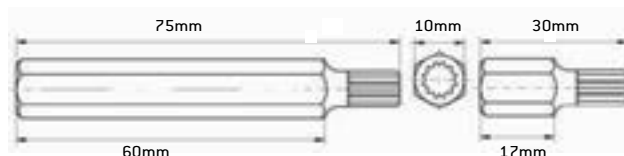
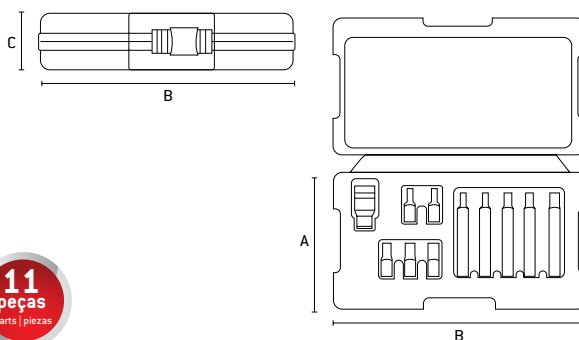

- Encaixe Sextavado 10 mm | Fitting Sixth 10 mm | Encaje Sextavado 10 mm
- Caixa Plástica | Plastic box | Caja de plástico

Caixa de bits /Ponteira Sextavado / adaptador de 1/2" x 10 mm

Bit set Box Sixth grade / Tip | Caja de bits / Puntera hexagonal



15 peças
parts | piezas

Composição | Composition | composición:

- 1 adaptador | adapter 1/2" x 10 mm
- Bits 30mm: 4,0/5,0/6,0/7,0/8,0/10/12mm
- Bits 75mm: 4,0/5,0/6,0/7,0/8,0/10/12mm

11313	1131356	Bits Sextavado	767g	DIMENSÕES SIZE TAMAÑO (MM)			30	0
				A	B	C		

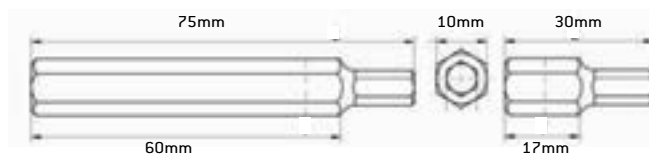
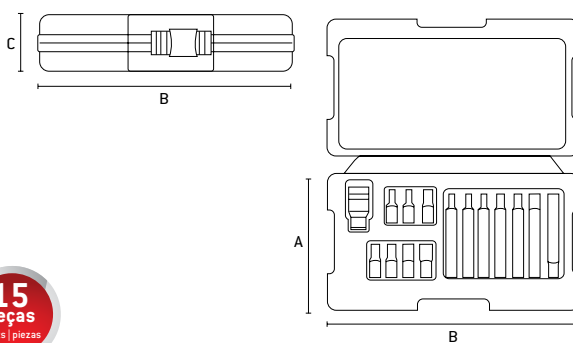

- Caixa Plástica | Plastic box | Caja de plástico

Caixa de bits /Ponteira Torx / adaptador de 1/2 x 10 mm

Bit set Box Torx / Tip | Caja de bits / Puntera Torx



15
peças
parts | piezas

Composição | Composition | composición:

- 1 adaptador | adapter 3/8" x 1/2"mm
- Bits 30mm: T20/T25/T30/T40/T45/T50/T55
- Bits 75mm: T20/T25/T30/T40/T45/T50/T55

NOVO	1131556	Bits Torx	738g	DIMENSÕES SIZE TAMAÑO (MM)			Quant. Min.
				A	B	C	0

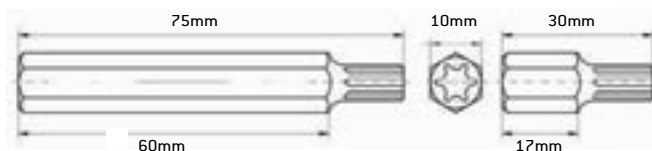
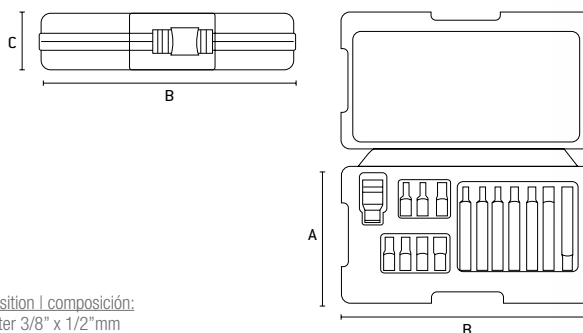

- Caixa Plástica | Plastic box | Caja de plástico

Caixa de bits /Ponteira Multidentada / adaptador de 1/2" x 10 mm

Bit set Box Multidentate / Tip | Caja de bits / Puntera Multidentate

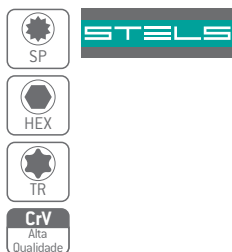

42
peças
parts | piezas

NOVO	1131856	Bits Hex Torx Spline	1.692g	DIMENSÕES SIZE TAMAÑO (MM)			Quant. Min.
				A	B	C	0

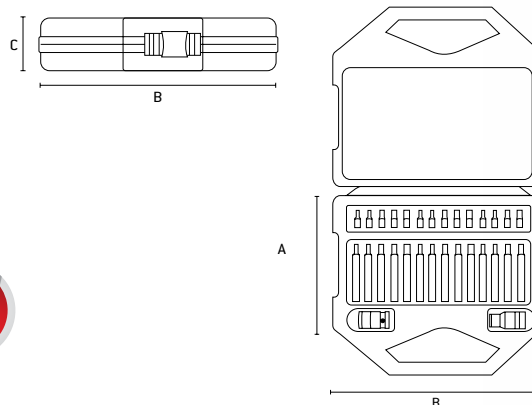

Composição | Composition | composición:

- 1 adaptador | adapter 3/8" x 10mm
- 1 adaptador | adapter 1/2" x 10mm
- (7 unid.) HEX Bits 4-5-6-7-8-10-12 x 30
- (7 unid.) HEX Bits 4-5-6-7-8-10-12 x 75
- (8 unid.) Bits Torx 20-25-30-40-45-50-55-60 x 30
- (8 unid.) Bits Torx 20-25-30-40-45-50-55-60 x 75
- (5 unid.) Spline Bits M5-6-8-10-12 x 30
- (5 unid.) Spline Bits M5-6-8-10-12 x 75

- Caixa Plástica | Plastic box | Caja de plástico

• SPLINE

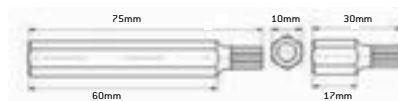

• HEX

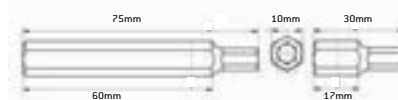

• TORX



Chaves Fenda / Phillips Série CABO VERDE

Screwdrivers / Phillips Series Green Cable |

Llaves Destornillador / Phillips - Serie Cabo verde

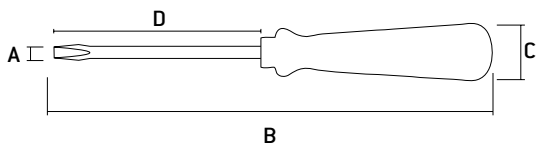

Barcode	SKU	DIMENSÕES SIZE TAMAÑO [MM]				Box	Quant. Min.
		A	B	C	D		
1140155	1/8" X 3.1/8" (SL3 X 80 MM)	3	150	15	80	144	12
1140255	1/8" X 4" (SL3 X 100 MM)	3	200	15	100	144	12
1140355	1/8" X 5" (SL3 X 125 MM)	3	225	15	125	144	12
1140455	1/8" X 6" (SL3 X 150 MM)	3	250	15	150	144	12
1140555	3/16" X 1.1/2" (SL5 X 38 MM)	5	100	18	38	144	12
1140655	3/16" X 3" (SL5 X 75 MM)	5	160	18	75	144	12
1140755	3/16" X 6" (SL5 X 150 MM)	5	260	18	150	144	12
1140855	1/4" X 1.1/2" (SL6 X 38 MM)	6	100	25	38	288	12
1140955	1/4" X 4" (SL6 X 100 MM)	6	200	25	100	144	12
1141055	1/4" X 5" (SL6 X 125 MM)	6	225	25	125	144	12
1141155	1/4" X 6" (SL6 X 150 MM)	6	250	25	150	144	12
1141255	1/4" X 8" (SL6 X 200 MM)	6	300	25	200	144	12
1141355	1/4" X 10" (SL6 X 250 MM)	6	350	25	250	144	12
1141455	5/16" X 5" (SL8 X 125 MM)	8	225	25	125	72	12
1141555	5/16" X 6" (SL8 X 150 MM)	8	250	25	150	72	12
1141655	5/16" X 8" (SL8 X 200 MM)	8	300	25	200	72	12
1141755	5/16" X 10" (SL8 X 250 MM)	8	350	25	250	72	12
1141855	3/8" X 6" (SL9,5 X 150 MM)	9.5	250	25	150	72	12
1141955	3/8" X 8" (SL9,5 X 200 MM)	9.5	300	25	200	72	12
1142055	3/8" X 10" (SL9,5 X 250 MM)	9.5	350	25	250	72	12
1145155	1/8" X 2" (PH0 X 50 MM)	0	100	15	50	144	12
1145255	1/8" X 3" (PH0 X 75 MM)	0	150	15	75	144	12
1145355	1/8" X 5" (PH0 X 125 MM)	0	225	15	125	144	12
1145455	1/8" X 6" (PH0 X 150 MM)	0	250	15	150	144	12
1145555	3/16" X 1.1/2" (PH1 X 38 MM)	1	43	18	38	144	12
1145655	3/16" X 3" (PH1 X 75 MM)	1	150	18	75	144	12
1145755	3/16" X 4" (PH1 X 100 MM)	1	200	18	100	144	12
1145855	3/16" X 6" (PH1 X 150 MM)	1	250	18	150	144	12
1145955	1/4" X 1.1/2" (PH2 X 38 MM)	2	100	25	38	144	12
1146055	1/4" X 4" (PH2 X 100 MM)	2	200	25	100	144	12
1146155	1/4" X 5" (PH2 X 125 MM)	2	225	25	125	144	12
1146255	1/4" X 6" (PH2 X 150 MM)	2	250	25	150	144	12
1146355	5/16" X 6" (PH3 X 150 MM)	3	250	25	150	72	12
1146455	5/16" X 8" (PH3 X 200 MM)	3	300	25	200	72	12
1146555	3/8" X 6" (PH4 X 150 MM)	4	250	25	150	72	12
1146655	3/8" X 8" (PH4 X 200 MM)	4	300	25	200	72	12

- Cabo anatômico | Anatomical cable | Cable anatómico
- Cabo plástico de dois componentes | Two-component rubberized cable | Cable de goma de dos componentes
- Embalagem: Clipe Plástico | Packing: Plastic Clip | Embalaje: Clip Plástico



Jogo de Chaves Fenda / Phillips

Phillips / Screwdrivers Set | Juego de Llaves Destornillador / Phillips

			DIMENSÕES SIZE TAMAÑO (MM)				
1178255	SL/PH	483g	A	B	C	30	15



6 peças
parts | piezas

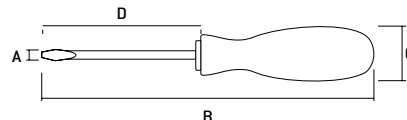

CHAVE CORRESPONDENTE CORRESPONDING KEY CLAVE CORRESPONDENTE	A	B	D
SL 4	4,0	200	100
SL 5	4,0	200	100
SL 6	4,0	250	150
PH 0	4,0	200	80
PH 1	4,0	200	100
PH 2	4,0	250	150

- Cabo anatômico | Anatomical cable | Mango anatómico
- Cabo emborrachado de dois componentes | Two-component rubberized cable | Mango de goma de dos componentes
- Ponta Imantada | Magnetized Tip | Puntada magnetizada

Chaves Fenda / Phillips Série Point

Screwdrivers / Key Phillips - Point Series | Llaves Destornillador / Phillips - Serie Point

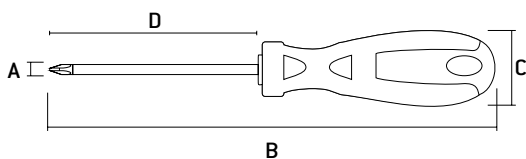
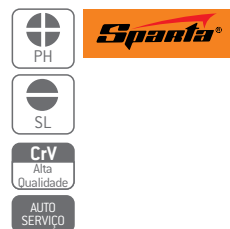

Código	Especificação	DIMENSÕES SIZE TAMAÑO (MM)				Quant. Min.	
		A	B	C	D		
1176055	1/8" X 2" (SL3 X 50 MM)	3	100	25	50	240	12
1176155	1/8" X 3" (SL3 X 75 MM)	3	150	25	75	240	12
1176255	1/8" X 4" (SL3 X 100 MM)	3	200	25	100	240	12
1176355	1/8" X 5" (SL3 X 125 MM)	3	225	25	125	240	12
1176455	1/8" X 6" (SL3 X 150 MM)	3	250	25	150	240	12
1176555	3/16" X 1.1/2" (SL5 X 38 MM)	5	100	25	38	240	12
1176655	3/16" X 3" (SL5 X 75 MM)	5	150	25	75	240	12
1176755	3/16" X 4" (SL5 X 100 MM)	5	200	25	100	192	12
1176855	3/16" X 5" (SL5 X 125 MM)	5	225	25	125	192	12
1176955	3/16" X 6" (SL5 X 150 MM)	5	250	25	150	192	12
1177055	1/4" X 1.1/2" (SL6 X 38 MM)	6	100	25	38	192	12
1177155	1/4" X 4" (SL6 X 100 MM)	6	200	25	100	192	12
1177255	1/4" X 5" (SL6 X 125 MM)	6	225	25	125	192	12
1177355	1/4" X 6" (SL6 X 150 MM)	6	250	25	150	192	12
1177455	1/4" X 8" (SL6 X 200 MM)	6	300	25	200	192	12
1177555	5/16" X 6" (SL8 X 150 MM)	8	250	25	150	144	12
1177655	5/16" X 8" (SL8 X 200 MM)	8	300	25	200	144	12
1177755	5/16" X 10" (SL8 X 250 MM)	8	350	25	250	144	12
1177855	3/8" X 6" (SL9,5 X 150 MM)	9,5	250	25	150	144	12
1177955	3/8" X 8" (SL9,5 X 200 MM)	9,5	300	25	200	144	12
1178055	3/8" X 10" (SL9,5 X 250 MM)	9,5	350	25	250	144	12
1178155	1/8" X 2" (PH0 X 50 MM)	0	130	25	50	240	12
1178255	1/8" X 3" (PH0 X 75 MM)	0	160	25	75	240	12
1178355	1/8" X 5" (PH0 X 125 MM)	0	210	25	125	240	12
1178455	1/8" X 6" (PH0 X 150 MM)	0	230	25	150	240	12
1178555	3/16" X 1.1/2" (PH1 X 38 MM)	1	160	25	38	240	12
1178655	3/16" X 3" (PH1 X 75 MM)	1	210	25	75	192	12
1178755	3/16" X 4" (PH1 X 100 MM)	1	190	25	100	192	12
1178855	3/16" X 6" (PH1 X 150 MM)	1	240	25	150	192	12
1178955	1/4" X 1.1/2" (PH2 X 38 MM)	2	100	25	38	240	12
1179055	1/4" X 4" (PH2 X 100 MM)	2	200	25	100	192	12
1179155	1/4" X 5" (PH2 X 125 MM)	2	220	25	125	192	12
1179255	1/4" X 6" (PH2 X 150 MM)	2	250	25	150	192	12
1179355	5/16" X 6" (PH3 X 150 MM)	3	260	25	150	144	12
1179455	5/16" X 8" (PH3 X 200 MM)	3	310	25	200	144	12
1179555	3/8" X 6" (PH4 X 150 MM)	4	260	25	150	144	12
1179655	3/8" X 8" (PH4 X 200 MM)	4	290	25	200	144	12

- Cabo anatômico | Anatomical cable | Cable anatómico
- Cabo emborrachado de dois componentes | Two-component rubberized cable | Cable de goma de dos componentes
- Embalagem: Clipe Plástico | Packing: Plastic Clip | Embalaje: Clip Plástico

Chave Teste 140mm

Teste Key 140mm | Llave Test 140mm



NOVO	100V a 500V	12g	DIMENSÕES SIZE TAMAÑO (MM) A	1200	Quant. Min. 20
1304055			130		

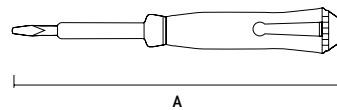

- Haste niquelada | Nickel plated rod | Vástago niquelado
- Capacidade 100V a 500V | Capacity 100V to 500V | Capacidad 100V a 500V
- Não indicada para soltar ou apertar parafusos | Not suitable for loosening or tightening screws | No indicado para soltar o apertar tornillos

Chave Teste 190mm

Teste Key 190mm | Llave Test 190mm



NOVO	100V a 500V	20g	DIMENSÕES SIZE TAMAÑO (MM) A	1200	Quant. Min. 20
1306055			120		

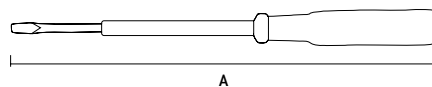

- Haste niquelada | Nickel plated rod | Vástago niquelado
- Capacidade 100V a 500V | Capacity 100V to 500V | Capacidad 100V a 500V
- Não indicada para soltar ou apertar parafusos | Not suitable for loosening or tightening screws | No indicado para soltar o apertar tornillos

Multiteste Digital LCD

Multitest Digital LCD | Multifunción Digital LCD



NOVO	12V - 220V	DIMENSÕES SIZE TAMAÑO (MM) A	500	Quant. Min. 20
1308055	Medições 12V - 220V	170		

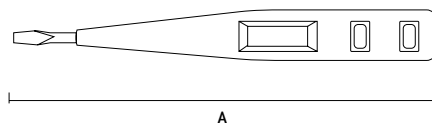

- Escala de medição 12V-220V | Measuring range 12V-220V | Escala de medición 12V-220V
- Medições de tensão (V) e verificação de polaridade | Voltage measurements (V) and polarity check | Mediciones de tensión (V) y verificación de polaridad
- Display LCD | LCD Display | Pantalla LCD
- Não indicada para soltar ou apertar parafusos | Not suitable for loosening or tightening screws | No indicado para soltar o apertar tornillos

Multiteste Digital LCD led

Multitest Digital LCD led | Multifunción Digital LCD led



NOVO	DIMENSÕES SIZE TAMAÑO (MM) A	500	Quant. Min. 20
1308555	180		



- Medições CA e CC 12V, 36V, 55V, 110V e 220V

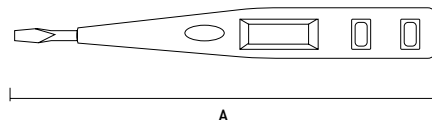

- DIN VDE 0680 Teil 6 04.77 e norma europeia CE. | DIN VDE 0680 Teil 6 04.77 and European standard CE. | DIN VDE 0680 Teil 6 04.77 y norma europea CE.
- O Multiteste digital foi projetado para detecção de tensão nas redes elétricas, verificação do estado e polaridade das baterias e pilhas secas, verificação de fios para detectar a descontinuidade, detecção de micro-ondas e radiação eletromagnética. | The Digital Multiteste is designed for voltage detection in electrical networks, verification of the state and polarity of batteries and dry batteries, wires to detect discontinuity, microwave detection and electromagnetic radiation. | El Multiteste digital está diseñado para la detección de tensión en las redes eléctricas, la verificación del estado y la polaridad de las baterías y las pilas secas, hilos para detectar la discontinuidad, la detección de microondas y la radiación electromagnética.
- Visor Digital e lâmpada neon | Digital display and neon lamp | Pantalla digital y lámpara de neón
- Não indicada para soltar ou apertar parafusos | Not suitable for loosening or tightening screws | No indicado para soltar o apertar tornillos

Jogo de Chaves de Precisão 6pçs
Precision Key Set 6pcs | Juego de llaves de precisión 6pzs



1334455	PH/SL	100	Quant. Min. 0
---------	-------	-----	---------------

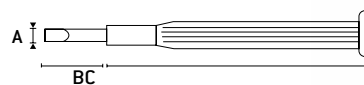

CHAVE CORRESPONDENTE CORRESPONDING KEY CLAVE CORRESPONDENTE	KG	DIMENSÕES SIZE TAMAÑO (MM)		
		A	B	C
SL1,4	5g	1.4	22	58
SL2,0	6g	2.0	22.5	65
SL2,4	7g	2.4	26	68
SL3,0	12g	3.0	28	75
PH00	7g	2.4	24.5	70
PH0	11g	3.0	30	75

- Ideal para manutenção de relógios, óculos e componentes eletrônicos | Ideal for maintenance of watches, glasses and electronic components | Ideal para el mantenimiento de relojes, gafas y componentes electrónicos

Jogo de Chaves de Precisão imantado - 8pçs
Precision Key Set magnetized - 8pcs | Juego de llaves de precisión imantado - 8pzs

115899	SL, PH, TR	371g	DIMENSÕES SIZE TAMAÑO (MM)		6	Quant. Min. 6
			A 140	B 190		

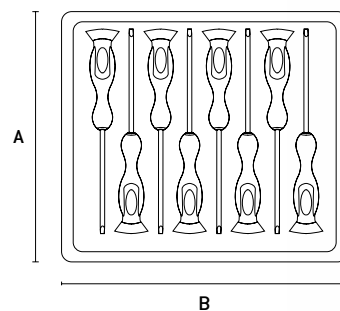

Composição | Composition | composición:
SL2,0 | SL2,4 | SL3,0 | PH00 | PH0 | TR 5 | TR 6

- Aço CrV | Stel CrV | Acero CrV
- Ideal para manutenção de relógios, óculos e componentes eletrônicos | Ideal for maintenance of watches, glasses and electronic components | Ideal para el mantenimiento de relojes, gafas y componentes electrónicos

Jogo de Chaves de Precisão 6pçs
Precision Key Set 6pcs | Juego de llaves de precisión 6pzs



13346	1334666	PH/SL	96	Quant. Min. 12
-------	---------	-------	----	----------------

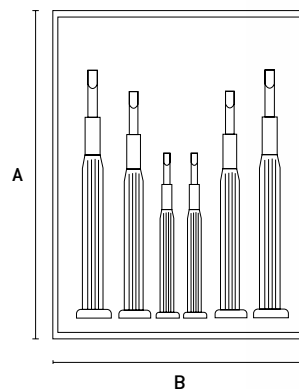

Composição | Composition | composición:
SL1,4 | SL2,0 | SL2,4 | PH00 | PH0 | PH1

- Aço CrMo | Stel CrMo | Acero CrMo
- Ferramenta de alta precisão | High precision tool | Herramienta de alta precisión
- Uso industrial | Industrial use | Uso industrial
- Ideal para manutenção de relógios, óculos e componentes eletrônicos | Ideal for maintenance of watches, glasses and electronic components | Ideal para el mantenimiento de relojes, gafas y componentes electrónicos

Jogo de Ferramentas para Bancada 6pçs

Bench Top Tool Set 6pcs | Juego de herramientas para banco 6pzs



6 peças
parts | piezas



COMPOSIÇÃO COMPOSITION COMPOSICIÓN	KG	DIMENSÕES SIZE TAMAÑO (MM)		
		A	B	C
1 MARTELO HAMMER MARTILLO	298g	100	285	20
1 ALICATE PLIERS ALICATE	174g	100	160	10
1 TRENA MEASURING TAPE CINTA MÉTRICA	50g	56	57	2MT
1 CHAVE DE FENDA SCREWDRIVER DESTORNILLADOR	174g	2.9	47	87
1 CHAVE PHILLIPS PHILLIPS SCREWDRIVER LLAVE PHILLIPS	174g	4.9	65	87
1 ESTILETE STILETTO CUCHILLO	174g	40	150	15

- Indicada para pequenos trabalhos do dia a dia | Suitable for everyday small jobs | Indicada para pequeños trabajos del día a día

Jogo de Ferramentas para Bancada 129pçs

Bench Top Tool Set 129pcs | Juego de herramientas para banco 129pzs



129 peças
parts | piezas

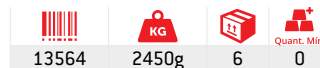

Composição | Composition | composición:

- 1 alicate bico meia cana reto 6" (160mm) | Snipe Nose Pliers | Pinza Punta Media Caña
- 1 alicate corte diagonal 6" (160mm) | diagonal cutting pliers | Pinza corte diagonal
- 1 alicate prensa terminais | pliers terminal presses | alicate prensa terminales
- Jogo com 20 bits: | Game with bits | Juego con bits
(Hex H3 - H4 - H5 - H6 mm)
(Quadrado S1 - S2 | Square cuadrado);
(Adaptador | Adapter);
(Torx T10 - T15 - T20 - T25);
(Pozidriv 0-1-2);
(Phillips 1-2-3);
(Fenda 3-4-5)
- Jogo com 16 chave Allen: | Set with Allen wrench | Juego con llave Allen
(1,5 - 2 - 2,5 - 3 - 4 - 5 - 5,5 - 6mm);
(1/16" - 5/64" - 3/32" - 1/8" - 5/32" - 3/16" - 7/32" - 1/4")

- Cabo anatômico com catraca para bits | Anatomical cable with ratchet for bits | Cable anatómico con trinquete para bits
- 4 chaves de precisão | precision wrenches | llaves de precisión
- Chaves ajustáveis / inglesa 6" (150mm) | Adjustable wrenches / English | llaves ajustables / inglés
- Estilete | Stilet 9mm
- Martelo unha 250g cabo metálico emborrachado | Nail hammer rubberized metallic handle | Martillo uña cable metálico de goma
- Nível 9" (230mm) com 3 bolhas | Level 9" (230mm) with 3 bubbles | Nivel 9" (230mm) con 3 burbujas
- 10 parafusos 6mm, cabeça chata zincado Phillips | Phillips 6mm Screws, Phillips Galvanized Flat Head | tornillos 6mm, cabeça plana zincado Phillips
- 46 pregos de aço com cabeça 20mm | steel studs with head 20mm | clavos de acero con cabeza 20mm
- 5 parafusos máquina cabeça redonda com porca sextavada | round head machine screws with hex nut | tornillos máquina cabeça redonda con tuerca hexagonal
- 4 ganchos | hooks
- 10 buchas plásticas para fixação 6mm | plastic bushings for fastening 6mm | Buchas plásticas para fijación 6mm
- Trena 3,5m x 12mm | measuring tape | cinta métrica
- Maleta plástica | Plastic suitcase |

Chave Inglesa Cromada

Chrome Plated Wrench | Llave Inglesa Cromada



AUTO SERVIÇO



NOVO	KG	DIMENSÕES SIZE TAMAÑO (MM)				Quant. Min.	
		A	B	C	D		
1552055	6" (150 mm)	60	150	5	19	60	6
1552555	8" (200 mm)	70	240	5	24	60	6
1553055	10" (250 mm)	70	250	5	30	60	6
1553555	12" (300 mm)	70	310	5	36	48	6
1554055	15" (375 mm)	87	370	24	46	24	6
1554555	18" (450 mm)	120	470	50	50	12	0

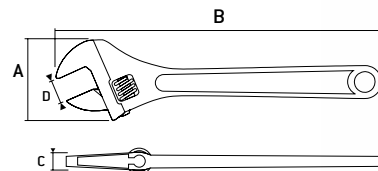

- Indicada para fixar ou soltar porcas e parafusos quadrados e sextavados | Suitable for tightening or loosening square and hexagonal nuts and bolts | Indicada para apretar o soltar tuercas y tornillos cuadrados y hexagonales

Chave Inglesa cabo emborrachado

Wrench Rubber Cable | Llave de cable de cobre



BLISTER



NOVO	KG	DIMENSÕES SIZE TAMAÑO (MM)				Quant. Min.	
		A	B	C	D		
155019	6" (150 mm)	86	235	13	12	48	6
155039	8" (200 mm)	105	270	15	19	36	6
155059	10" (250 mm)	111	333	17	16	24	6
155079	12" (300 mm)	115	383	20	20	24	6
155119	18" (450 mm)	188	535	26	32	10	0

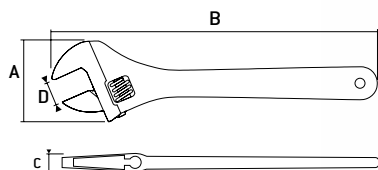

- Indicada para fixar ou soltar porcas e parafusos quadrados e sextavados | Suitable for tightening or loosening square and hexagonal nuts and bolts | Indicada para apretar o soltar tuercas y tornillos cuadrados y hexagonales
- Cabeça polida | Polished head | Cabeza pulida
- Aço Carbono | Carbon steel | Acero carbono

Escala em milímetro para determinar a abertura
Scale in millimeter to determine aperture
Escala en milímetro para determinar la apertura



Jogo de Ferramentas de montagem 40pçs

Mounting Tools Set 40pcs | Juego de herramientas de montaje 40pzs



AUTO SERVIÇO



NOVO	KG	DIMENSÕES SIZE TAMAÑO (MM)			Quant. Min.	
		A	B	C		
13565	850g	195	420	62	24	12

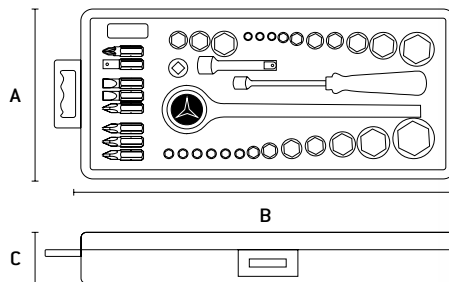

40 peças
parts | piezas

Composição | Composition | composición:

- 8 bits
- 26 cabeçotes terminais | endheads | cabezas terminales
- 1 chave de catraca | ratchet wrench | llave de trinquete
- 1 cabo de extensão | extension cable | cable de extensión
- 1 adaptador de bit | bit adapter | adaptador de bits
- 1 chave de fenda quadrada | square screwdriver | destornillador cuadrado

Chave de grifo Modelo Heavy Duty

Pipe wrench Heavy Duty Model | Llave de grifo Modelo Heavy Duty



- Tipo Americano | American type | Tipo Americano
- Uso Industrial | Industrial use | Uso Industrial
- Mordente em aço | Steel chevron | Mordente de acero

Código	Tamanho	DIMENSÕES SIZE TAMAÑO (MM)				Quant. Min.	
		A	B	C	D		
1570155	8" (200 mm)	50	200	20	40	72	6
1570255	10" (250 mm)	60	250	20	50	48	6
1570355	12" (300 mm)	70	300	20	60	36	6
1570455	14" (350 mm)	75	350	20	70	24	6
1570555	18" (450 mm)	90	457	35	80	12	6
1570655	24" (600 mm)	95	600	30	90	10	5
1570755	36" (900 mm)	130	900	40	100	6	3

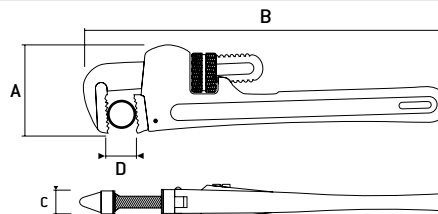

Chave de grifo em alumínio

Griffin key aluminum | Llave de grifo de aluminio



- Corpo em alumínio, super leve e altamente resistente | Super light and highly resistant aluminum body | Cuerpo en aluminio, súper ligera y altamente resistente
- Tipo Americano | American type | Tipo Americano
- Para Tubos | For Tubes | Para Tubos
- Uso Profissional | Professional Use | Uso Profesional

Código	Tamanho	DIMENSÕES SIZE TAMAÑO (MM)				Quant. Min.	
		A	B	C	D		
1560155	10" (250 mm)	56	250	20	50	48	0
1560255	12" (300 mm)	60	300	20	60	36	0
1560355	14" (350 mm)	80	350	25	70	24	0
1560455	18" (450 mm)	90	457	40	80	12	0
1560555	24" (600 mm)	100	600	30	90	10	0
1560655	36" (900 mm)	120	900	40	100	6	0

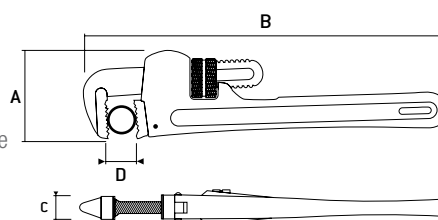

Chave de grifo tipo Stillson

Pipe wrench Type Stillson | Llave de grifo tipo Stillson



- Para Tubos | For Tubes | Para Tubos
- Uso Profissional | Professional Use | Uso Profesional

Código	Tamanho	Peso	DIMENSÕES SIZE TAMAÑO (MM)				Quant. Min.	
			A	B	C	D		
157565	10" (250 mm)	504g	68	230	15,5	50,8	48	6
157645	14" (350 mm)	977g	76	300	18	63,5	24	4
157685	18" (450 mm)	1456g	100	460	18	83,5	18	0

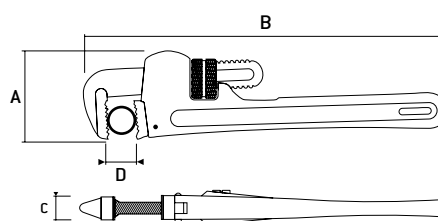

Chave de grifo Inclinado

Inclined Griffin key | Llave de grifo Inclinado



- Facilita o acesso nos lugares difíceis | Facilitates access in difficult places | Facilita el acceso en lugares difíciles
- Tipo Americano | American type | Tipo Americano
- Mordente em aço | Steel chevron | Mordente de acero
- Uso Profissional | Professional Use | Uso Profesional

Código	Tamanho	DIMENSÕES SIZE TAMAÑO (MM)				Quant. Min.	
		A	B	C	D		
1571155	8" (200 mm)	45	200	20	40	48	0
1571255	10" (250 mm)	60	250	20	50	36	0
1571355	12" (300 mm)	65	300	30	60	24	0
1571455	14" (350 mm)	80	350	20	70	24	0
1571555	18" (450 mm)	90	457	30	80	12	0
1571655	24" (600 mm)	110	600	40	90	10	0
1571755	36" (900 mm)	130	900	50	100	4	0

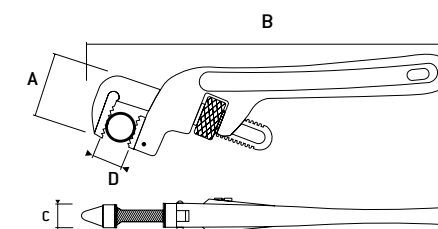

Jogo de Limas Agulha Diamantadas - 5 pçs

Set of Diamond Needle Files | Juego de limas Aguja Diamantada



5 peças
parts | piezas

158339	140x70x3mm	DIMENSÕES SIZE TAMAÑO (MM)		200	20
		A	B		

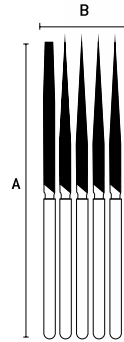

- Ideal para afiação de ferramentas com Wídea | Ideal for tool edging with Wídea | Ideal para afinación de herramientas con Wídea
- Indicada para ourives e pessoas que trabalhem com pequenas peças | Indicated for goldsmiths and people who work with small parts | Indicada para orillos y personas que trabajen con pequeñas piezas
- Embalagem: Plástica | Packing: Plastic | Embalaje: Plástico

Lima Formato Plano

Flat Scraper | Raspador plano



1622055	4" (100 mm)	DIMENSÕES SIZE TAMAÑO (MM)		144	12
		A	B		
1622355	6" (150 mm)	15	270	72	12
1622655	8" (200 mm)	52	310	72	12
1622955	10" (250 mm)	25	390	72	12
1623255	12" (300 mm)	55	440	48	12

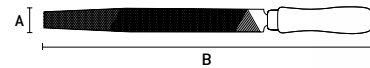

- Murça | Murça | Murça
- Cabo de Madeira | Wooden Cape | Cable de madera

Lima Formato Triangular

Triangular shape scraper | Rascador Formato Triangular



1602055	4" (100 mm)	DIMENSÕES SIZE TAMAÑO (MM)		144	12
		A	B		
1602355	6" (150 mm)	50	260	72	12
1602655	8" (200 mm)	50	310	72	12
1602955	10" (250 mm)	50	370	72	12
1603255	12" (300 mm)	55	450	48	12

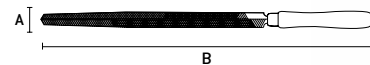

- Murça | Murça | Murça
- Cabo de Madeira | Wooden Cape | Cable de madera

Lima Formato Meia Cana

Half Cane Scraper | Rascador Formato Medias Cana



1632055	4" (100 mm)	DIMENSÕES SIZE TAMAÑO (MM)		144	12
		A	B		
1632355	6" (150 mm)	40	260	72	12
1632655	8" (200 mm)	53	322	72	12
1632955	10" (250 mm)	55	392	72	12
1633255	12" (300 mm)	54	453	48	12

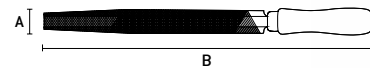

- Murça | Murça | Murça
- Cabo de Madeira | Wooden Cape | Cable de madera

Lima Formato Redondo

Round Scraper | Rascador Formato Redondo



1612055	4" (100 mm)	DIMENSÕES SIZE TAMAÑO (MM)		144	12
		A	B		
1612355	6" (150 mm)	50	260	72	12
1612655	8" (200 mm)	100	310	72	12
1612955	10" (250 mm)	100	180	72	12
1613255	12" (300 mm)	55	436	48	12

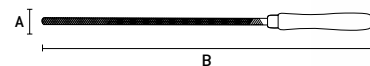

- Murça | Murça | Murça
- Cabo de Madeira | Wooden Cape | Cable de madera



1

Lima Formato Triangular



	DIMENSÕES SIZE TAMAÑO (MM)	DIMENSÕES SIZE TAMAÑO (MM)		Quant. Min.	
		A	B		
1603355	4" (100 mm)	50	200	144	12
1603455	6" (150 mm)	50	260	72	12
1603555	8" (200 mm)	50	310	72	12
1603655	10" (250 mm)	50	370	72	12
1603755	12" (300 mm)	55	450	48	12



- Bastarda | Bastard | Bastardo
- Cabo de Madeira | Wooden Cape | Cable de madera

Lima Formato Redondo



	DIMENSÕES SIZE TAMAÑO (MM)	DIMENSÕES SIZE TAMAÑO (MM)		Quant. Min.	
		A	B		
1613355	4" (100 mm)	50	200	144	12
1613455	6" (150 mm)	50	260	72	12
1613555	8" (200 mm)	10	310	72	12
1613655	10" (250 mm)	10	380	72	12
1613755	12" (300 mm)	55	436	48	12

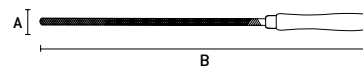

- Bastarda | Bastard | Bastardo
- Cabo de Madeira | Wooden Cape | Cable de madera

Lima Formato Plano



	DIMENSÕES SIZE TAMAÑO (MM)	DIMENSÕES SIZE TAMAÑO (MM)		Quant. Min.	
		A	B		
1623355	4" (100 mm)	52	200	144	12
1623455	6" (150 mm)	52	270	72	12
1623555	8" (200 mm)	52	310	72	12
1623655	10" (250 mm)	25	390	72	12
1623755	12" (300 mm)	55	440	48	12

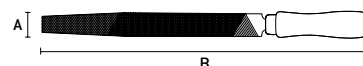

- Bastarda | Bastard | Bastardo
- Cabo de Madeira | Wooden Cape | Cable de madera

Lima Formato Meia Cana



	DIMENSÕES SIZE TAMAÑO (MM)	DIMENSÕES SIZE TAMAÑO (MM)		Quant. Min.	
		A	B		
1633355	4" (100 mm)	40	200	144	12
1633455	6" (150 mm)	40	260	72	12
1633555	8" (200 mm)	53	322	72	12
1633655	10" (250 mm)	55	392	72	12
1633755	12" (300 mm)	54	453	48	12

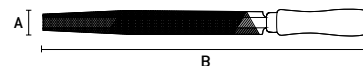

- Bastarda | Bastard | Bastardo
- Cabo de Madeira | Wooden Cape | Cable de madera

Lima Formato Triangular



1584255	8" (200 mm)	DIMENSÕES SIZE TAMARO (MM)		72	12
		A	B		



- Murça | Murça | Murça
- Cabo plástico | plastic cable | cable de plástico

Lima Formato Redonda



1584655	8" (200 mm)	DIMENSÕES SIZE TAMARO (MM)		72	12
		A	B		



- Murça | Murça | Murça
- Cabo plástico | plastic cable | cable de plástico

Lima Formato Quadrada



1584455	8" (200 mm)	DIMENSÕES SIZE TAMARO (MM)		72	12
		A	B		

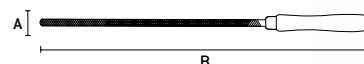

- Murça | Murça | Murça
- Cabo plástico | plastic cable | cable de plástico

Lima Formato Chata



1584155	8" (200 mm)	DIMENSÕES SIZE TAMARO (MM)		72	12
		A	B		



- Murça | Murça | Murça
- Cabo plástico | plastic cable | cable de plástico



1

Lima Formato Meia-Cana



1584855	8" (200 mm)	DIMENSÕES SIZE TAMAÑO (MM)		72	12
		A	B		

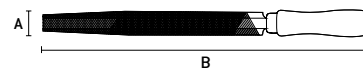

- Bastarda | Bastard | Bastardo
- Cabo plástico | plastic cable | cable de plástico

Jogo De Limas Bastardas 3 pçs



1585255	8" (200 mm)	DIMENSÕES SIZE TAMAÑO (MM)		40	0
		A	B		

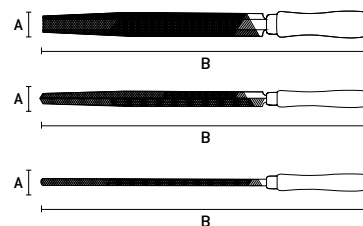

- Bastarda | Bastard | Bastardo
- Cabo plástico | plastic cable | cable de plástico

Jogo De Limas Bastardas 5 pçs



1585455	8" (200 mm)	DIMENSÕES SIZE TAMAÑO (MM)		20	0
		A	B		

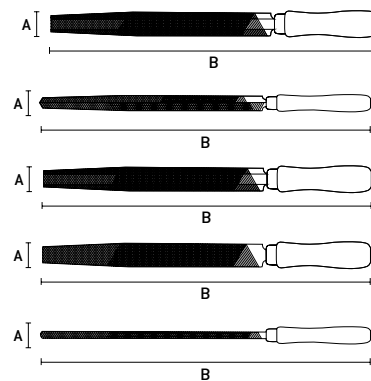

- Bastarda | Bastard | Bastardo
- Cabo plástico | plastic cable | cable de plástico

Mandril Aperto Rápido

Fast Clamp Chuck | Mandril Apriete Rápido



168089	Rosca 1/2", 1-10mm	189g	DIMENSÕES SIZE TAMANO [MM]		50	80	50	1
			A	B				

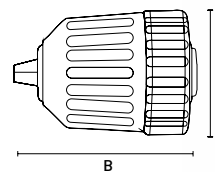

- Não utiliza chave | Does not use a key | No utiliza clave
- Embalagem: Caixa | Packing: Box | Embalaje: Caja

Mandril Auto Lock

Auto Lock Chuck | Mandril Auto Lock



168079	Rosca 1/2", 2-13mm	325g	DIMENSÕES SIZE TAMANO [MM]		50	80	50	1
			A	B				

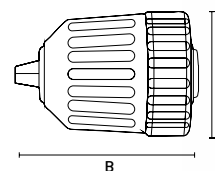

- APERTO RÁPIDO | QUICK START | APERTURA RÁPIDA
- Função Auto Lock (trava de segurança para evitar o desbloqueio da broca) | Auto Lock function (safety lock to prevent unlocking of the drill bit) | Función Auto Lock (bloqueo de seguridad para evitar el desbloqueo de la broca)
- Não utiliza chave | Does not use a key | No utiliza clave
- Embalagem: Caixa | Packing: Box | Embalaje: Caja

SISTEMA EXCLUSIVO MTX
MTX EXCLUSIVE SYSTEM
SISTEMA EXCLUSIVO MTX

Mandril de Chave Manual

Manual Switch Chuck | Mandril de llave manual



168179	Rosca 1/2", 1,5-13mm	335g	DIMENSÕES SIZE TAMANO [MM]		50	80	50	1
			A	B				
168189	Rosca 3/8", 1,5-13mm	361g	50	80	50	50	1	
168199	CONE b16, 3-16mm	617g	70	90	30	30	1	
168209	CONE b18, 3-16mm	647g	60	90	30	30	1	
168229	CONE b12, 1,5-13mm	364g	50	80	50	50	1	

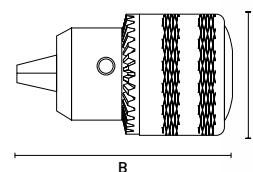

- Com furo passante | With through hole | Con agujero pasante
- Acompanha chave | Accompany key | Acompaña clave
- Embalagem: Caixa | Packing: Box | Embalaje: Caja

Chave para Mandril

Chuck wrench | Llave para Mandril



168859	Isolado Isolated Aislado - 10 mm	76	137	14	100	20
168869	Isolado Isolated Aislado - 13 mm	76	137	17	80	15
168899	Isolado Isolated Aislado - 16 mm	75	135	25	100	20
1689059	oxidado rusty oxidado - 10 mm	76	137	15	100	20
1689559	oxidado rusty oxidado - 13 mm	76	137	20	100	20



168859/168869/168899

- Isolado | Isolated | Aislado

1689059/1689559

- oxidado | rusty | oxidado

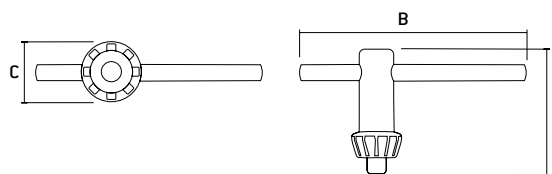

Mini Alicate Bico Meia-Cana Reto (125mm)

Pliers Beak Half-Cane Straight Mini | Pinza Punta Media-Canã Reto Mini



- Reforçado | Reinforced | Reforzado
- Acabamento Fosfatizado | Phosphated Finish | Acabado Fosfatizado

1783055	5" (125 mm)	109g	DIMENSÕES SIZE TAMAÑO (MM)			60	10
			A	B	C		

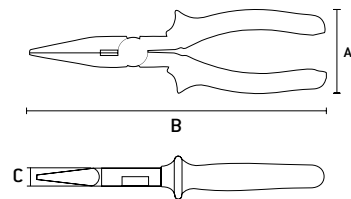

Mini Alicate Bico Meia-Cana Curvo (125mm)

Pliers Beak Half-Cane Curved Mini | Pinza Punta Media-Canã Curvo Mini



- Reforçado | Reinforced | Reforzado
- Acabamento Fosfatizado | Phosphated Finish | Acabado Fosfatizado

1783155	5" (125 mm)	109g	DIMENSÕES SIZE TAMAÑO (MM)			60	10
			A	B	C		

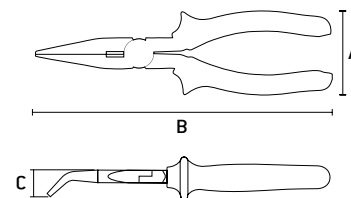

Mini Alicate Corte Diagonal (110mm)

Diagonal Cutting Pliers Mini | Pinza Corte Diagonal Mini



- Lâmina de corte temperada | Hardened cutting blade | Lámina de corte templada
- Reforçado | Reinforced | Reforzado
- Acabamento Fosfatizado | Phosphated Finish | Acabado Fosfatizado

1783255	4.1/2" (110 mm)	109g	DIMENSÕES SIZE TAMAÑO (MM)			60	10
			A	B	C		

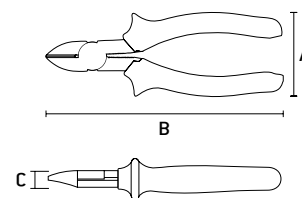

Mini Alicate Universal (120mm)

Universal pliers Mini | Alicate Universal Mini



- Reforçado | Reinforced | Reforzado
- Acabamento Fosfatizado | Phosphated Finish | Acabado Fosfatizado

1783355	4.3/4" (120 mm)	109g	DIMENSÕES SIZE TAMAÑO (MM)			60	10
			A	B	C		

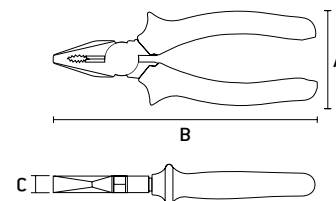

Mini Alicate Bico Meia-Cana Curvo Longo (150mm)

Mini Pliers Long Beak Medium Curved | Mini Pinza Punta Media-Canã Curvo Largo



- Reforçado | Reinforced | Reforzado
- Acabamento Fosfatizado | Phosphated Finish | Acabado Fosfatizado

1783455	6" (150 mm)	109g	60	10
DIMENSÕES SIZE TAMAÑO (MM)				
A	B	C		
85	185	25		

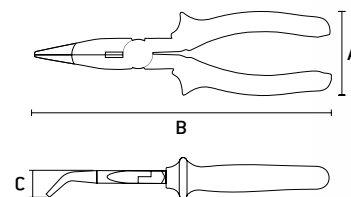

Mini Alicate Bico Redondo (127mm)

Mini Round Bead Pliers | Mini Pinza Punta Redonda



- Reforçado | Reinforced | Reforzado
- Acabamento Fosfatizado | Phosphated Finish | Acabado Fosfatizado

1783555	5" (125 mm)	109g	60	10
DIMENSÕES SIZE TAMAÑO (MM)				
A	B	C		
85	185	25		

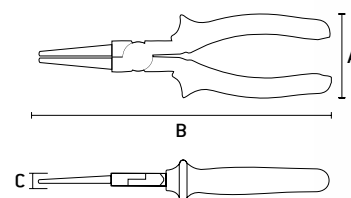

Mini Alicate (127mm)

Mini Round Bead Pliers | Mini Pinza Punta Redonda



- Reforçado | Reinforced | Reforzado
- Acabamento Fosfatizado | Phosphated Finish | Acabado Fosfatizado

1783655	5" (125 mm)	109g	60	10
DIMENSÕES SIZE TAMAÑO (MM)				
A	B	C		
85	185	25		

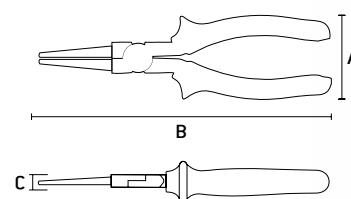

Mini Alicate Corte Frontal (105mm)

Mini Front Cutting Pliers | Mini Pinza Corte Frontal



- Lâmina de corte temperada | Hardened cutting blade | Lámina de corte templada
- Reforçado | Reinforced | Reforzado
- Acabamento Fosfatizado | Phosphated Finish | Acabado Fosfatizado

1783755	4.1/2" (105 mm)	109g	60	10
DIMENSÕES SIZE TAMAÑO (MM)				
A	B	C		
85	185	25		

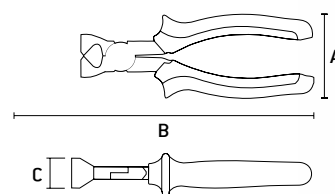

Mini Alicate Bico Meia-Cana Reto (125mm)

Pliers Beak Half-Cane Straight Mini | Pinza Punta Media-Canã Reto Mini



			DIMENSÕES SIZE TAMAÑO (MM)				
1719755	6.1/2" (125 mm)	109g	A	B	C	36	Quant. Min. 6

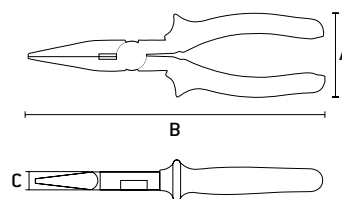

- Reforçado | Reinforced | Reforzado
- Acabamento Fosfatizado | Phosphated Finish | Acabado Fosfatizado

Alicate Corte Diagonal (150mm)

Diagonal Cutting Pliers | Pinza Corte Diagonal



			DIMENSÕES SIZE TAMAÑO (MM)				
1754855	6" (150 mm)	109g	A	B	C	36	Quant. Min. 6

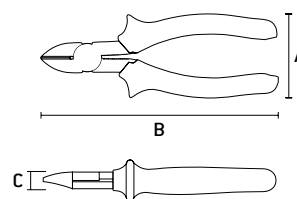

- Reforçado | Reinforced | Reforzado
- Acabamento Fosfatizado | Phosphated Finish | Acabado Fosfatizado

Alicate Universal Combinada

Universal Combination Pliers | Alicate Universal Combinado



			DIMENSÕES SIZE TAMAÑO (MM)				
1706155	8" (200 mm)	373g	A	B	C	36	Quant. Min. 6

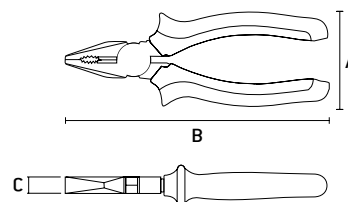

- Reforçado | Reinforced | Reforzado
- Acabamento Fosfatizado | Phosphated Finish | Acabado Fosfatizado

Alicate Bico Meia-Cana Reto Níckel

Pliers Beak Half-Cane Straight Nickel | Pinza Punta Media-Canã Reto Níckel



			DIMENSÕES SIZE TAMAÑO (MM)				
171649	6" (160 mm)	202g	A	B	C	60	6

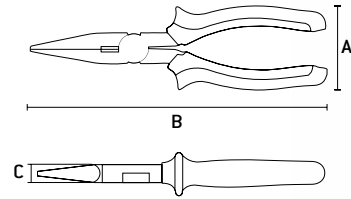

- Linha Níckel | Nickel Line | Línea Níckel
- Acabamento polido | Polished finish | Acabado pulido
- Cabo Plástico anatômico com dois componentes | Cable Anatomic plastic with two components | Mango plástico anatômico con dos componentes
- Embalagem: Clipe Plástico | Packing: Plastic Clip | Embalaje: Clip Plástico

Alicate Bico Meia-Cana Curvo Níckel

Pliers Beak Half-Cane Curved Nickel | Pinza Punta Media-Canã Curvo Níckel



			DIMENSÕES SIZE TAMAÑO (MM)				
174229	7" (180 mm)	245g	A	B	C	60	6

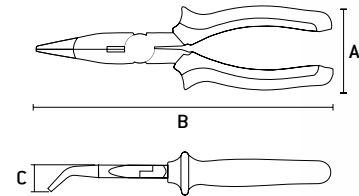

- Linha Níckel | Nickel Line | Línea Níckel
- Acabamento polido | Polished finish | Acabado pulido
- Cabo Plástico anatômico com dois componentes | Cable Anatomic plastic with two components | Mango plástico anatômico con dos componentes
- Embalagem: Clipe Plástico | Packing: Plastic Clip | Embalaje: Clip Plástico

Alicate Corte Diagonal Níckel

Diagonal Cutting Pliers Nickel | Pinza Corte Diagonal Níckel



			DIMENSÕES SIZE TAMAÑO (MM)				
175209	6" (160 mm)	225g	A	B	C	60	6
175229	7" (180 mm)	285g	64	242	27	60	6

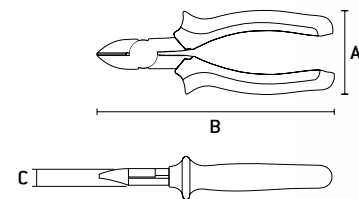

- Linha Níckel | Nickel Line | Línea Níckel
- Lâmina de corte temperada | Hardened cutting blade | Lámina de corte templada
- Acabamento polido | Polished finish | Acabado pulido
- Cabo Plástico anatômico com dois componentes | Cable Anatomic plastic with two components | Mango plástico anatômico con dos componentes
- Embalagem: Clipe Plástico | Packing: Plastic Clip | Embalaje: Clip Plástico

Alicate Universal Níckel

Universal pliers Nickel | Alicates Universal Nickel



			DIMENSÕES SIZE TAMAÑO (MM)				
169069	8" (200 mm)	365g	A	B	C	60	6

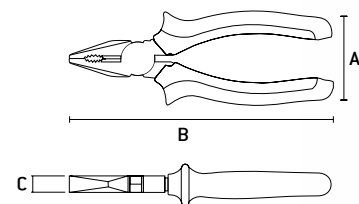

- Linha Níckel | Nickel Line | Línea Níckel
- Acabamento polido | Polished finish | Acabado pulido
- Cabo Plástico anatômico com dois componentes | Cable Anatomic plastic with two components | Mango plástico anatômico con dos componentes
- Embalagem: Clipe Plástico | Packing: Plastic Clip | Embalaje: Clip Plástico



Alicate Bico Meia-Cana Reto Black Níckel

Pliers Beak Half-Cane Straight Black Nickel | Pinza Punta Media-Canã Reto Black Níckel



171589	6" (160 mm)	195g	DIMENSÕES SIZE TAMAÑO (MM)			60	6
			A	B	C		

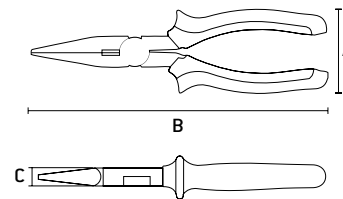

- Linha Black Níckel | Black Nickel Line | Línea Black Níckel
- Acabamento polido | Polished finish | Acabado pulido
- Cabo Plástico anatômico com dois componentes | Cable Anatomic plastic with two components | Cable plástico anatómico con dos componentes
- Embalagem: Clipe Plástico | Packing: Plastic Clip | Embalaje: Clip Plástico

Alicate Corte Diagonal Black Níckel

Diagonal Cutting Pliers Black Nickel | Pinza Corte Diagonal Black Níckel



175729	6" (160 mm)	222g	DIMENSÕES SIZE TAMAÑO (MM)			60	6
			A	B	C		
175749	7" (180 mm)	273g	64	248	25	60	6

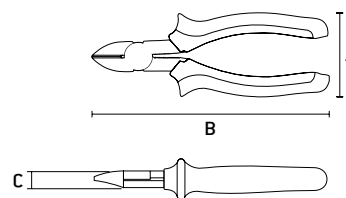

- Linha Black Níckel | Black Nickel Line | Línea Black Níckel
- Acabamento polido | Polished finish | Acabado pulido
- Cabo Plástico anatômico com dois componentes | Cable Anatomic plastic with two components | Cable plástico anatómico con dos componentes
- Embalagem: Clipe Plástico | Packing: Plastic Clip | Embalaje: Clip Plástico

Alicate Universal Níckel

Universal pliers Nickel | Alicate Universal Nickel



169789	6" (160 mm)	243g	DIMENSÕES SIZE TAMAÑO (MM)			60	6
			A	B	C		
169839	8" (200 mm)	363g	60	250	20	60	6

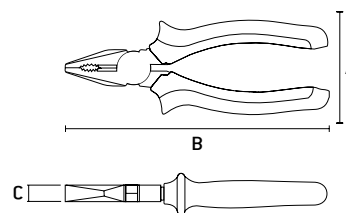

- Linha Black Níckel | Black Nickel Line | Línea Black Níckel
- Acabamento polido | Polished finish | Acabado pulido
- Cabo Plástico anatômico com dois componentes | Cable Anatomic plastic with two components | Cable plástico anatómico con dos componentes
- Embalagem: Clipe Plástico | Packing: Plastic Clip | Embalaje: Clip Plástico

Removedor para anéis de pressão com bicos

Pressure Ring Remover with Nozzles | Eliminador para anillos de presión con boquillas



1835055	6" (150 mm)	175g	DIMENSÕES SIZE TAMAÑO (MM)		48	6
			A	B		

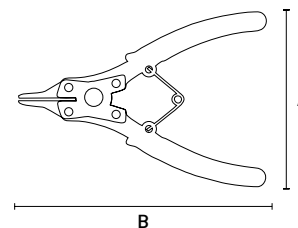

- Para anéis de retenção internos e externos (furos) | For internal and external retaining rings (holes) | Para anillos de retención internos y externos (agujeros)
- Bicos retos e curvos | Straight and curved nozzles | Boquillas rectas y curvas
- Acabamento fosfatizado | Phosphatized Finish | Acabado fosfatizado
- Uso industrial | Industrial use | Uso industrial

ALICATES VDE para Eletricistas



Alicate Bico Meia-Cana Reto VDE

Pliers Beak Half-Cane Straight VDE | Pinza Punta Média-Canã Reto VDE



171019	6" (160 mm)	180g	DIMENSÕES SIZE TAMANHO (MM)			60	5
			A	B	C		

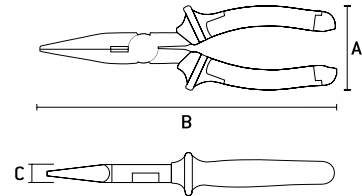

- Linha VDE | VDE Line | Línea VDE
- Acabamento polido | Polished finish | Acabado pulido
- Embalagem: Clipe Plástico | Packing: Plastic Clip | Embalaje: Clip Plástico

Alicate Corte Diagonal VDE

Diagonal Cutting Pliers VDE | Pinza Corte Diagonal VDE



175069	6" (160 mm)	232g	DIMENSÕES SIZE TAMANHO (MM)			60	5
			A	B	C		

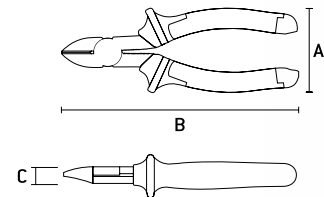

- Linha VDE | VDE Line | Línea VDE
- Acabamento polido | Polished finish | Acabado pulido
- Embalagem: Clipe Plástico | Packing: Plastic Clip | Embalaje: Clip Plástico

Alicate Universal VDE

Universal pliers Nickel | Alicates Universal Nickel



169059	8" (200 mm)	522g	DIMENSÕES SIZE TAMANHO (MM)			60	5
			A	B	C		

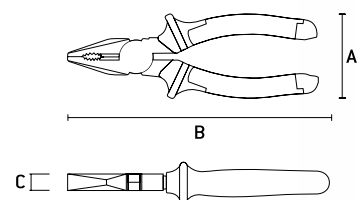

- Linha VDE | VDE Line | Línea VDE
- Acabamento polido | Polished finish | Acabado pulido
- Embalagem: Clipe Plástico | Packing: Plastic Clip | Embalaje: Clip Plástico

Alicate Bico Meia-Cana Reto Mini

Pliers Beak Half-Cane Straight Mini | Pinza Punta Media-Canã Reto Mini



- Cabo emborrachado | Rubberized cable | Cable de goma
- Embalagem: Clipe Plástico | Packing: Plastic Clip | Embalaje: Clip Plástico

NOVO	1782055	5" (130 mm)	74g	DIMENSÕES SIZE TAMAÑO (MM)			120	6
				A	B	C		

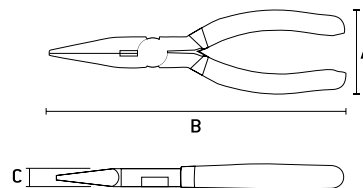

Alicate Bico Meia-Cana Curvo Mini

Pliers Beak Half-Cane Curved Mini | Pinza Punta Media-Canã Curvo Mini



- Cabo emborrachado | Rubberized cable | Cable de goma
- Embalagem: Clipe Plástico | Packing: Plastic Clip | Embalaje: Clip Plástico

NOVO	1782255	5" (130 mm)	79g	DIMENSÕES SIZE TAMAÑO (MM)			120	6
				A	B	C		

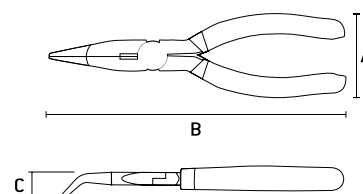

Alicate Corte Diagonal Mini

Diagonal Cutting Pliers Mini | Pinza Corte Diagonal Mini



- Cabo emborrachado | Rubberized cable | Cable de goma
- Embalagem: Clipe Plástico | Packing: Plastic Clip | Embalaje: Clip Plástico

NOVO	1782455	5" (130 mm)	69g	DIMENSÕES SIZE TAMAÑO (MM)			120	6
				A	B	C		

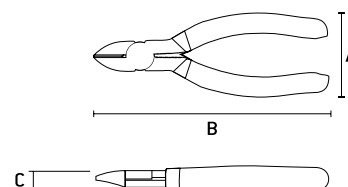

Alicate Universal Mini

Universal pliers Mini | Alicate Universal Mini



- Cabo emborrachado | Rubberized cable | Cable de goma
- Embalagem: Clipe Plástico | Packing: Plastic Clip | Embalaje: Clip Plástico

NOVO	1782655	5" (130 mm)	79g	DIMENSÕES SIZE TAMAÑO (MM)			120	6
				A	B	C		

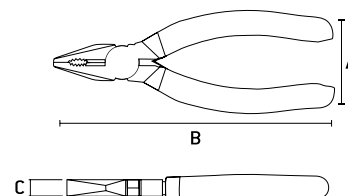

Mini Alicate Bico Meia-Cana Reto

Mini Pliers Beak Half-Cane Straight | Mini Pinza Punta Media-Canã Reto



			DIMENSÕES SIZE TAMAÑO (MM)				
178109	5" (130 mm)	104g	A	B	C	120	6

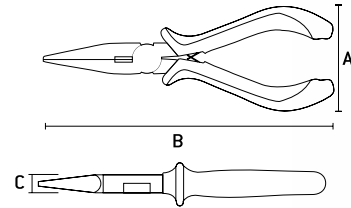

- Acabamento polido | Polished finish | Acabado pulido
- Cabo Plástico anatômico com dois componentes | Cable Anatomic plastic with two components | Cable plástico anatómico con dos componentes

Mini Alicate Bico Meia-Cana Curvo

Mini Pliers Beak Half-Cane Curved | Mini Pinza Punta Media-Canã Curvo



			DIMENSÕES SIZE TAMAÑO (MM)				
178129	5" (130 mm)	109g	A	B	C	120	12

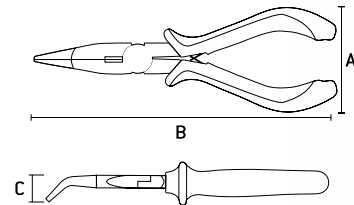

- Acabamento polido | Polished finish | Acabado pulido
- Cabo Plástico anatômico com dois componentes | Cable Anatomic plastic with two components | Cable plástico anatómico con dos componentes

Mini Alicate Corte Diagonal

Mini Diagonal Cutting Pliers | Mini Pinza Corte Diagonal



			DIMENSÕES SIZE TAMAÑO (MM)				
178149	5" (130 mm)	100g	A	B	C	120	6

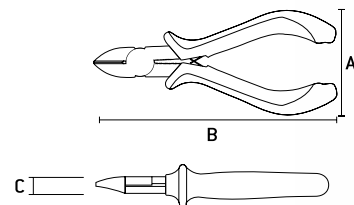

- Acabamento polido | Polished finish | Acabado pulido
- Cabo Plástico anatômico com dois componentes | Cable Anatomic plastic with two components | Cable plástico anatómico con dos componentes

Mini Alicate Universal

Mini Universal pliers | Mini Alicate Universal



			DIMENSÕES SIZE TAMAÑO (MM)				
178169	5" (130 mm)	112g	A	B	C	120	6

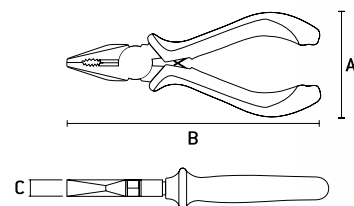

- Acabamento polido | Polished finish | Acabado pulido
- Cabo Plástico anatômico com dois componentes | Cable Anatomic plastic with two components | Cable plástico anatómico con dos componentes



Alicate externo Bico Curvo

External pliers Beak Curved | Pinza externa Punta curva



			DIMENSÕES SIZE TAMAÑO (MM)				
1832055	6" (150 mm)	138g	A	B	C	60	6

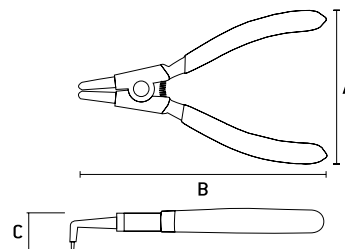

- Para anéis de retenção externos (furos) | For external retaining rings (holes) | Para anillos de retención externos (agujeros)
- Acabamento fosfatizado | Phosphatized Finish | Acabado fosfatizado
- Uso industrial | Industrial use | Uso industrial
- Embalagem: Clipe Plástico | Packing: Plastic Clip | Embalaje: Clip Plástico

Alicate interno Bico Curvo

Internal pliers Beak Curved | Pinza interna Punta curva



			DIMENSÕES SIZE TAMAÑO (MM)				
1832555	6" (150 mm)	124g	A	B	C	60	6

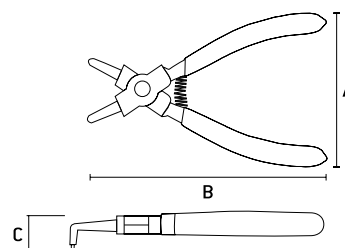

- Para anéis de retenção internos (furos) | For internal retaining rings (holes) | Para anillos de retención internos (agujeros)
- Acabamento fosfatizado | Phosphatized Finish | Acabado fosfatizado
- Uso industrial | Industrial use | Uso industrial
- Embalagem: Clipe Plástico | Packing: Plastic Clip | Embalaje: Clip Plástico

Alicate interno Bico Reto

Internal pliers Beak Reto | Pinza interna Punta Reto



			DIMENSÕES SIZE TAMAÑO (MM)				
1833555	6" (150 mm)	127g	A	B	C	60	6

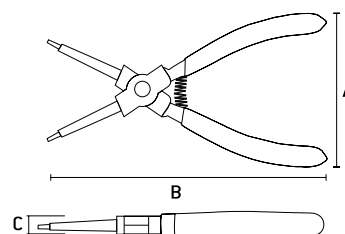

- Para anéis de retenção internos (furos) | For internal retaining rings (holes) | Para anillos de retención internos (agujeros)
- Acabamento fosfatizado | Phosphatized Finish | Acabado fosfatizado
- Uso industrial | Industrial use | Uso industrial
- Embalagem: Clipe Plástico | Packing: Plastic Clip | Embalaje: Clip Plástico

Alicate externo Bico Reto

External pliers Beak Reto | Pinza externa Punta Reto



			DIMENSÕES SIZE TAMAÑO (MM)				
1833055	6" (150 mm)	143g	A	B	C	60	6

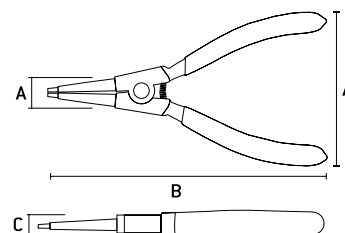

- Para anéis de retenção internos (furos) | For internal retaining rings (holes) | Para anillos de retención internos (agujeros)
- Acabamento fosfatizado | Phosphatized Finish | Acabado fosfatizado
- Uso industrial | Industrial use | Uso industrial
- Embalagem: Clipe Plástico | Packing: Plastic Clip | Embalaje: Clip Plástico

Torquês Armador

Concretor's Pincers | Tenaza para armar



Barcode	Size	Weight (KG)	DIMENSÕES SIZE TAMAÑO (MM)			Quant. Min.
			A	B	C	
1796455	10" (250 mm)	192g	65	242	60	6
1796555	12" (300 mm)	210g	65	300	60	6

AUTO SERVIÇO

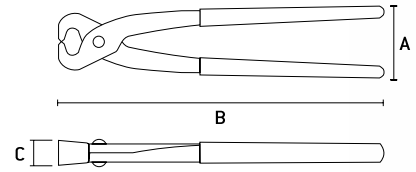

• Cabo emborrachado | Rubberized cable | Cable de goma

Torquês Azulejista

Tile Pincers | Tenaza para azulejo



Barcode	Size	Weight (KG)	DIMENSÕES SIZE TAMAÑO (MM)			Quant. Min.
			A	B	C	
1793455	6" (150 mm)	231g	56	163	22	6
1793855	8" (200 mm)	316g	60	210	23	8

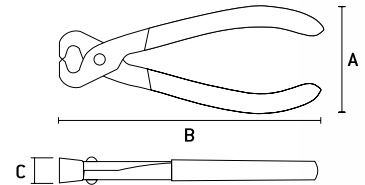

• Cabo emborrachado | Rubberized cable | Cable de goma

Alicate bomba d'água

Water Pump Pliers | Pinza Pico Loro



Barcode	Size	Weight (KG)	DIMENSÕES SIZE TAMAÑO (MM)			Quant. Min.
			A	B	C	
1571855	10" (250 mm)	382g	60	240	10	10
1571955	12" (300 mm)	597g	68	350	20	40

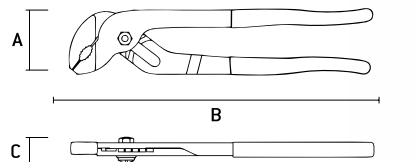

• Cabo emborrachado | Rubberized cable | Cable de goma

Alicate bomba d'água

Water Pump Pliers | Pinza Pico Loro



Barcode	Size	Weight (KG)	DIMENSÕES SIZE TAMAÑO (MM)			Quant. Min.
			A	B	C	
157089	10" (250 mm)	350g	65	350	24	6
157099	12" (300 mm)	694g	65	365	28	36

AUTO SERVIÇO

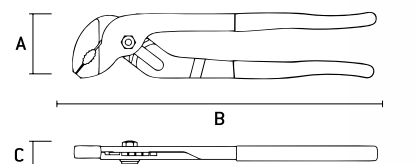

• Aço Carbono | Carbon steel | Acero carbono
 • Cabo dupla injeção com revestimento antiderrapante | Double injection cable with non-slip coating | Cable doble inyección con revestimiento antideslizante



Desencapador automático

Auto unplug | Desengrasador automático



			DIMENSÕES SIZE TAMAÑO (MM)					
1773055	6.1/2" (170 mm)	227g	A	B	C	60	6	

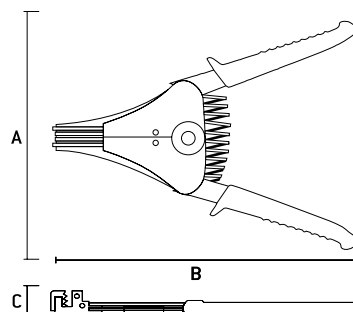

- Possibilita o desentape nas extremidades e no meio | Enables the release of the ends and the middle | Posibilita el desarrollo en las extremidades y en el medio
- Desentapa fios e cabos de 1.0mm a 3.2mm | Strips wires and cables from 1.0mm to 3.2mm | Desentapa cables y cables de 1.0mm a 3.2mm
- Fechamento controlado por mola | Spring-controlled closing | Cierre controlado por resorte

Desencapador de fios

Wire stripper | Desengrasador de cables



				DIMENSÕES SIZE TAMAÑO (MM)					
177505	1775055	8.9/32" (210 mm)	146g	A	B	C	D	100	10

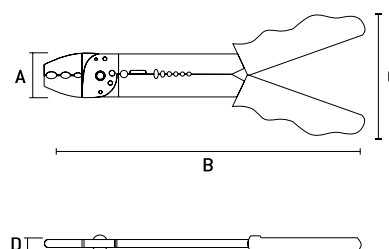

- Corta fios e cabos de bitolas 0.5mm a 6.5mm | Cut wire and wire sizes 0.5mm to 6.5mm | Corta hilos y cables de ancho de 0,5 mm a 6.5mm
- Desentapa fios e cabos de 1.5mm a 6.5mm | Strips wires and cables from 1.5mm to 6.5mm | Desentapa cables y cables de 1.5mm a 6.5mm



BITS COM LIMITADOR

BITS WITH LIMITATOR | BITS CON LIMITADOR

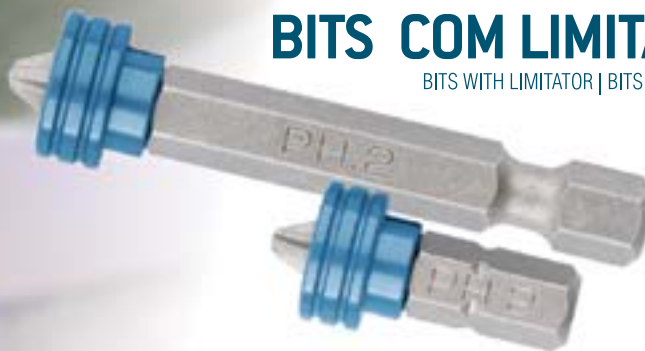

**Encaixe Sextavado 1/4" | Hex socket 1/4" | Encaje Sexto 1/4" •
 Imantado e com limitador | Magnetized and with limite | Magnetizado y con limitador •
 Tamanho: 25mm|50mm | Size: 25mm|50mm | Tamaño: 25mm|50mm •
 Aplicação para parede Gesso /Drywall | Wall application Plaster / Drywall | Aplicación para pared Yeso / Drywall**

DESENCAPADOR DE FIOS

AUTOMÁTICO COM PRENSA PARA TERMINAIS

Automatic wire stripper with press for terminals

Desençador de hilos automático con prensa para terminales

NOVO	KG	DIMENSÕES SIZE TAMAÑO (mm)		Quant. Min.
1771855	417g	A	B	6
		100	300	48

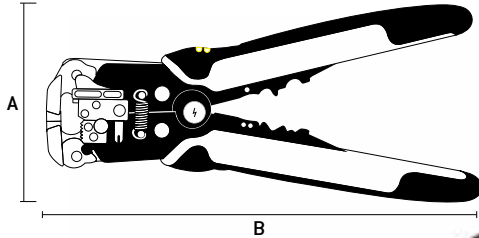

REGULADOR DE LIMITADOR



REGULADOR DE PRESSÃO



PRENSADOR DOS TERMINAIS



PRATICIDADE PARA EMENDAS

- Indicado para desençar cabos e fios com bitolas de 0,2 a 6,0mm (10-24 AWG)

Suitable for stripping cables and wires with gauges from 0.2 to 6.0mm

Indicado para desençar cables e hilos con anchuras de 0,2 a 6,0mm

- Com crimpador de terminais isolados e não isolados (10-22 AWG) de 0,50 a 6,0mm e cortador de fios.

With insulated and non-insulated (10-22 AWG) crimper from 0.50 to 6.0mm and wire cutter

Con cremallador de terminales aislados y no aislados (10-22 AWG) de 0,50 a 6,0 mm y cortador de hilos

- Cabo em aço carbono e lâminas de aço sintetizado de alta resistência.

Carbon steel cable and high strength synthetic steel blades. | Cable de aço carbono e lâminas de aço sintetizado de alta resistência.

- Cabo em polipropileno reforçado com revestimento emborrachado

Rubberized reinforced polypropylene cable | Cable de polipropileno reforçado com revestimento de goma

- Regulador de pressão para diferentes espessuras de fios | Pressure regulator for different wire thicknesses | Regulador de presión para diferentes espesores de hilos

- Limitador para ajuste de tamanho a ser desençado | Limiter for size adjustment to be stripped | Limitador para ajuste de tamaño a ser desençado

- Tamanho | Size | Tamaño: 8"

ALICATE CRIMPADOR

CATRACADO PARA CABOS RJ11, RJ12 e RJ45

Catched catching cranket for RJ11, RJ12 and RJ45 cables
Alicate crimpador catracado para cables RJ11, RJ12 y RJ45

novo	KG	DIMENSÕES SIZE TAMAÑO (mm)		Quant. Min.
1771955	406g	A	B	6
		95	290	48

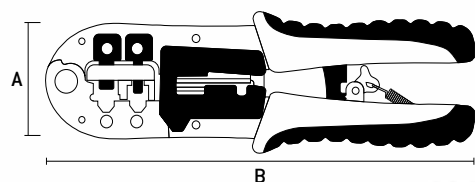

**PARA CONECTORES
8 E 6 PINOS**



**CORTADOR
E DECAPADOR**



CATRACA

- Indicado para Crimpar e Decapar cabos de rede e telefônicos.
Suitable for Crimping and Stripping Network and Telephone Cables. | Indicado para Crimpar y Decapar cables de red y telefônicos.
- Para cabos | For cables | Para cables: RJ11 - RJ12 - RJ45 / 6P e 8P.
- Cabo em aço e lâminas de corte em aço. | Steel cable and steel cutting blades. | Cable de acero y cuchillas de corte de acero.
- Cabo em polipropileno reforçado com revestimento emborrachado.
Reinforced polypropylene cable with rubberized coating. | Mango de polipropileno reforçado con revestimiento de goma.
- Tamanho | Size | Tamaño: 8"

Alicate de pressão mordente curvo

Curved cheek pressure pliers | Pinza de presión mordiente curvo



			DIMENSÕES SIZE TAMAÑO (MM)				
1843055	10" (250 mm)	465g	A	B	C	60	6

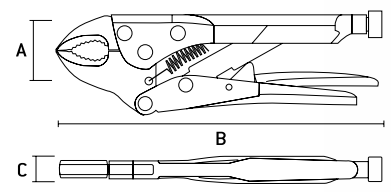

- Uso geral | General use | Uso general
- Niquelado | Nickel plated | níquel

Alicate de Pressão Mordente Reto

Pressure Munching Pliers | Alicate de Presión Mordiente Recto



			DIMENSÕES SIZE TAMAÑO (MM)				
1843155	10" (250 mm)	465g	A	B	C	60	6

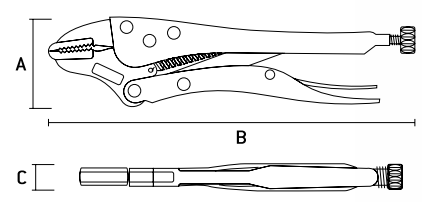

Alicate de Pressão Mordente Curvo Reto

Pressure Munching Pliers | Alicate de Presión Mordiente Recto



			DIMENSÕES SIZE TAMAÑO (MM)				
1843255	10" (250 mm)	465g	A	B	C	60	6

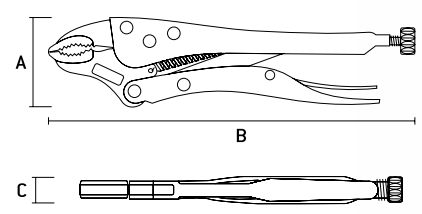

Alicate de Pressão Mordente Longo Reto

Pressure Munching Pliers | Alicate de Presión Mordiente Recto



			DIMENSÕES SIZE TAMAÑO (MM)				
1843355	9" (225 mm)	465g	A	B	C	60	6

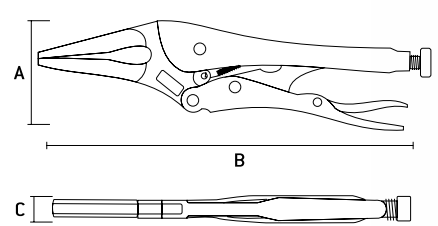

Alicate de Pressão Mordente Tipo C

Type U Munch Pressure Pliers | Alicate de presión Mordente Tipo C

AUTO
SERVIÇO



			DIMENSÕES SIZE TAMAÑO (MM)				
1843455	11" (275 mm)	465g	A	B	C	36	6

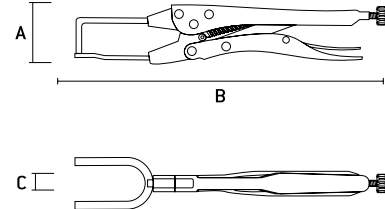
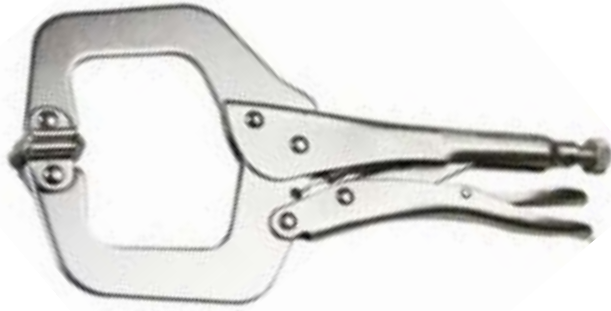

Alicate de Pressão Tipo Corrente

Current Type Pressure Pliers | Alicate de presión tipo corriente

AUTO
SERVIÇO



			DIMENSÕES SIZE TAMAÑO (MM)				
1843555	18" (460 mm)	465g	A	B	C	36	6

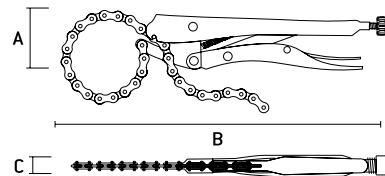

Alicate de Pressão Bico Chato

Flat Tip Pliers | Alicate de Presión Boquilla Chato

AUTO
SERVIÇO



			DIMENSÕES SIZE TAMAÑO (MM)				
1843655	8" (200 mm)	465g	A	B	C	48	6

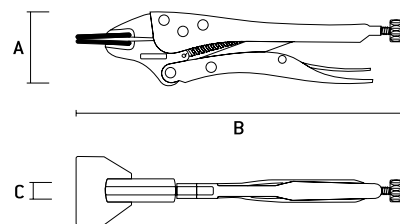

Talhadeira Plana

Flat Stone Chisel | Cincel Plano



Barcode	Icon	KG	DIMENSÕES SIZE TAMAÑO (MM)			Icon	Quant. Min.
			A	B	C		
1870155	8" (200 mm)	1000g	30	200	12	72	0
1870255	10" (250 mm)	1100g	30	250	12	48	0
1870355	12" (300 mm)	1200g	30	300	12	40	0

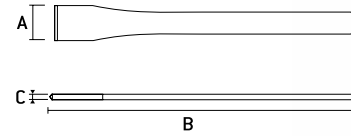

- Utilizada na construção civil | Used in construction | Utilizada en la construcción civil

Talhadeira Ponta Chata

Tip Flat Stone Chisel | Cincel Punta Plana



Barcode	Icon	KG	DIMENSÕES SIZE TAMAÑO (MM)			Icon	Quant. Min.
			A	B	C		
1871155	8" (200 mm)	1000g	30	200	20	72	0
1871255	10" (250 mm)	1100g	30	250	25	48	0
1871355	12" (300 mm)	1200g	30	300	30	40	0

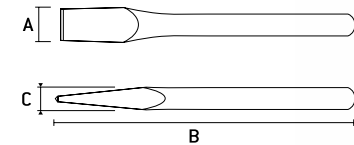

- Utilizada na construção civil | Used in construction | Utilizada en la construcción civil
- Corpo Redondo | Round body | Cuerpo Redondo

Ponteiro Redondo

Round Pointer | Puntero Redondo



Barcode	Icon	KG	DIMENSÕES SIZE TAMAÑO (MM)			Icon	Quant. Min.
			A	B	C		
1880155	8" (200 mm)	1000g	20	200	5	72	0
1880255	10" (250 mm)	1100g	25	250	5	48	0
1880355	12" (300 mm)	1200g	30	300	5	40	0

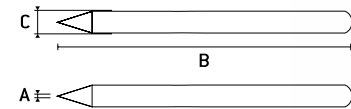

- Utilizada na construção civil | Used in construction | Utilizada en la construcción civil
- Corpo Redondo | Round body | Cuerpo Redondo

Talhadeira Sextavada com protetor

Hexagonal Cleaver with protector | Taladradora Sexta con protector



Barcode	Icon	KG	DIMENSÕES SIZE TAMAÑO (MM)		Icon	Quant. Min.
A	B					
1876055	300X25mm	531g	25	295	36	6

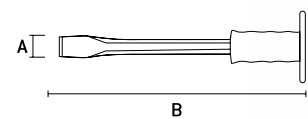

- Cabo com empunhadura plástica | Cable with plastic grip | Cable con empuñadura plástica
- Utilizadas em mecânicas, indústrias e cortes de chapas metálicas | Used in mechanics, industries and cuts of sheet metal | Utilizadas en mecánicas, industrias y cortes de chapas metálicas

Ponteiro Sextavada com protetor

Hexagonal Pointer with Protector | Puntero Sextava con protector



Barcode	Icon	KG	DIMENSÕES SIZE TAMAÑO (MM)		Icon	Quant. Min.
A	B					
1883455	300mm	528g	5	298	36	6

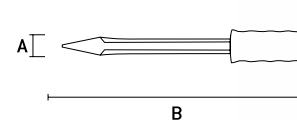

- Cabo com empunhadura plástica | Cable with plastic grip | Cable con empuñadura plástica
- Utilizadas em mecânicas, indústrias e cortes de chapas metálicas | Used in mechanics, industries and cuts of sheet metal | Utilizadas en mecánicas, industrias y cortes de chapas metálicas



1

MINI TORNO/MORSA ARTICULADO COM VENTOSA

Mini articulated vice / vise with suction cup
Mini torno / morsa articulado con ventosa



185069



1500g



A

B



20



1

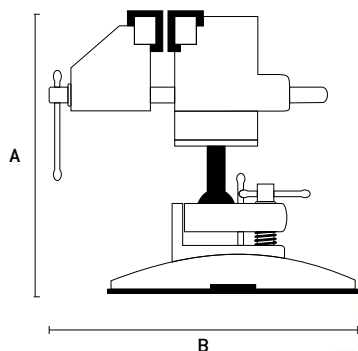

Mordentes emborrachados
- Rubber cheeks
- Mordazas emborrachadas



Base com ventosa para fixação
- Base with suction cup for attachment
- Base con ventosa para fijación

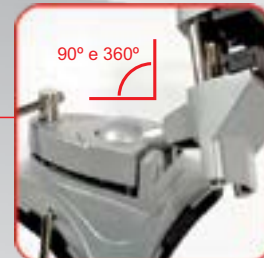

Articulação de 90° e 360°
- 90° and 360° Articulation
- Articulación de 90° e 360°

PARA SERVIÇOS LEVES E DELICADOS DE SOLDA, INSPEÇÃO, MONTAGEM, AJUSTES, POLIMENTO E ETC

For light and delicate welding services, inspection, assembly, adjustments, polishing and etc.
Para servicios ligeros y delicados de soldadura, inspección, montaje, ajustes, pulido y etc

- Possui base emborrachada que se prende a superfícies lisas e planas através de sucção de ar.
- Cabeça giratória a 360° e inclina até 90°
- Garras com pontas emborrachadas, mais segurança, firmeza e menor risco de estragar os objetos
- Manivelas de regulagem e travamento da base, das garras e da cabeça giratória
- Com esta ferramenta você pode trabalhar o mesmo objeto em diversos ângulos, sem a necessidade de ficar prendendo e desprendendo

- Has a rubber base that attaches to flat and smooth surfaces through air suction.
- Rotating 360° head and tilts up to 90°
- Rubber-tipped jaws, more safety, firmness and less risk of spoiling objects
- Adjusting and locking handles for base, claws and swivel head
- With this tool you can work the same object from several angles, without the need to be holding and releasing

- Posee una base de goma que se atiene a superficies lisas y planas a través de succión de aire.
- Cabeza giratoria a 360° e inclina hasta 90°
- Garras con puntas de goma, más seguridad, firmeza y menor riesgo de estropear los objetos
- Manivelas de regulación y bloqueo de la base, de las garras y de la cabeza giratoria
- Con esta herramienta usted puede trabajar el mismo objeto en diversos ángulos, sin la necesidad de quedar atrapando y desprendiendo

MINI TORNO/MORSA 70MM BASE ARTICULADA

Mini lathe / vise 70mm hinged base
Mini torno / morsa 70mm base articulada

185089	990g	DIMENSÕES SIZE TAMAÑO (mm)	A	B	20	1
--------	------	--------------------------------	---	---	----	---



90° e 360°



Mordentes emborrachados

- Rubber cheeks
- Mordazas emborrachadas



Suporte para Furadeira

- Drill Holder
- Soporte para Taladro



Articulação de 90° e 360°

- 90° and 360° Articulation
- Articulación de 90° e 360°



Encaixe da base emborrachado

- Rubber Base Fit
- Encaje de la base de goma

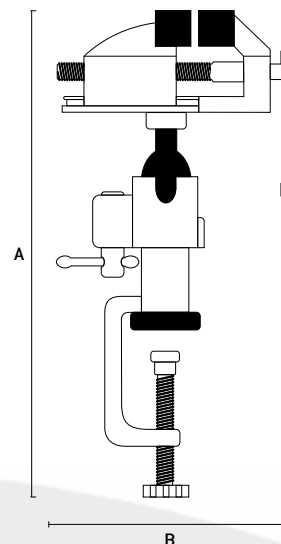

MULTIFUNCIONAL

| MULTIFUNCIONAL

Possui suporte de furadeira indicado para trabalhos leves, o suporte facilita muito na hora de fazer perfurações.

It has drill holder indicated for light work, the stand makes it much easier to drill holes.

Tiene soporte de taladro indicado para trabajos ligeros, el soporte facilita mucho a la hora de hacer perforaciones.

PARA FAZER ACABAMENTOS, CORTAR, LIMAR, LIXAR, ETC.

To make finishes, cut, lime, sand, etc.
Para hacer acabamentos, cortar, lima, lijar, etc.

TRABALHO PRÁTICO

| PRACTICAL WORK | TRABAJO PRACTICO

É ideal para realizar trabalhos que necessitam mobilidade para trabalhar perfeitamente em vários ângulos.

It is ideal for carrying out need mobility to work perfectly from various angles.

Es ideal para realizar trabajos que necesitan movilidad para trabajar perfectamente en varios ángulos.

Proporciona maior precisão na perfuração e menor possibilidade de quebra, principalmente das brocas finas.

Provides greater accuracy in drilling and less chance of breakage, mainly of fine drills.

Proporciona mayor precisión en la perforación y La menor posibilidad de rotura, principalmente de las brocas finas.

Tornos / Morsas de Bancada

Bench Vices | Prensatornillos



NOVO	DIMENSÕES SIZE TAMAÑO (MM)	DIMENSÕES SIZE TAMAÑO (MM)			Quant. Min.	
		A	B	C		
1850555	1.1/2" (40 mm)	118	88	40	20	0
1850755	2" (50 mm)	120	110	50	20	0
1850955	2.1/2" (60 mm)	124	110	60	20	0
1851155	3" (75 mm)	120	117	75	20	0

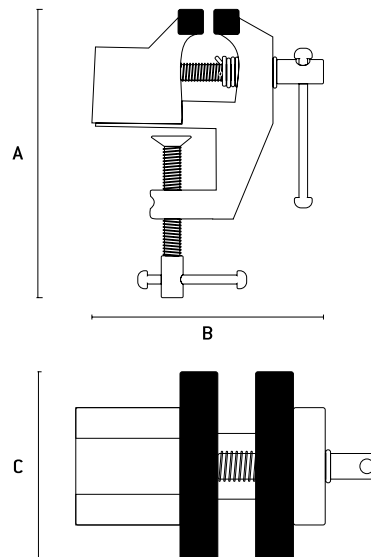

- Indicado para ferramentas, oficinas, serralherias e pra segurar peças e equipamentos em geral, na construção civil, e também na montagem e desmontagem de componentes | Indicated for tools, workshops, locksmiths and to insure parts and equipment in general, in civil construction, as well as assembly and disassembly of components | Indicado para herramientas, talleres, cerrajerías y para asegurar piezas y equipamientos en general, en la construcción civil, y también en el montaje y desmontaje de componentes

• Embalagem individual | Individual packing | Embalaje individual



Tornos / Morsas Base Giratória

Bench Vices | Prensatornillos



NOVO	DIMENSÕES SIZE TAMAÑO (MM)	DIMENSÕES SIZE TAMAÑO (MM)			Quant. Min.	
		A	B	C		
1862355	4" (100 mm)	133	265	100	1	0
1862555	5" (125 mm)	140	270	125	1	0
1862755	6" (150 mm)	170	345	150	1	0
1862955	8" (200 mm)	221	408	200	1	0

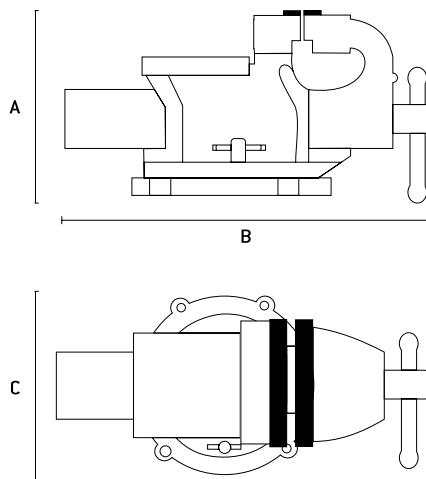

- Indicado para ferramentas, oficinas, serralherias e pra segurar peças e equipamentos em geral, na construção civil, e também na montagem e desmontagem de componentes | Indicated for tools, workshops, locksmiths and to insure parts and equipment in general, in civil construction, as well as assembly and disassembly of components | Indicado para herramientas, talleres, cerrajerías y para asegurar piezas y equipamientos en general, en la construcción civil, y también en el montaje y desmontaje de componentes

• Embalagem individual | Individual packing | Embalaje individual



FERRAMENTAS DE CARPINTEIRO

CARPENTER'S TOOLS
HERRAMIENTAS DE CARPINTERO

As ferramentas de carpinteiro GROSS, MTX e Sparta possuem ferramentas de extrema eficiência para o trabalho a ser desenvolvido. Utilizando matérias primas de qualidade as ferramentas tem um ótimo desempenho e proporcionam um excelente resultado. O profissional irá se surpreender com as ferramentas da marca GROSS e o usuário final com as ferramentas da MTX e Sparta..

The GROSS, MTX and Sparta carpenter tools have extreme efficiency tools for the job to be developed. Using quality raw materials the tools have a great performance and provide an excellent result. The professional will be amazed with the GROSS brand tools and the end user with MTX and Sparta tools.

Las herramientas de carpintero GROSS, MTX y Sparta poseen herramientas de extrema eficiencia para el trabajo a ser desarrollado. Utilizando materias primas de calidad las herramientas tienen un óptimo desempeño y proporcionan un excelente resultado. El profesional se sorprenderá con las herramientas de la marca GROSS y el usuario final con las herramientas de MTX y Sparta.

SIMBOLOGIA



CÓDIGO
CODE



CARACTERÍSTICAS
Technical Features



PESO DA PEÇA
Part Weight
Peso de la Pieza



CAIXA MASTER
Box Master | Caja Máster



QUANT. MINÍMA
Quant. Minimum
Cantidad Mínimo

Grampo Angular

Angular Cleat | Grapa Angular



NOVO	KG	DIMENSÕES SIZE TAMAÑO (MM)			Quant. Min.	
		A	B	C		
20320555	149g	75	210	110	100	10

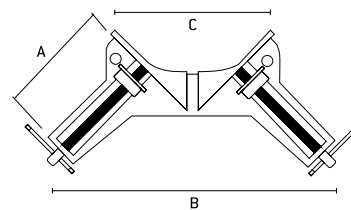

- Produzido em alumínio | Produced in aluminum | Producido en aluminios
- Ideal para esquadrear peças angulares | Ideal for squaring angled pieces | Ideal para encuadrar piezas angulares

Grampo Sargento Tipo F

Staple Sergeant Type F | Grapa Sargento Tipo F



	KG	DIMENSÕES SIZE TAMAÑO (MM)			Quant. Min.		
		A	B	C			
204029	6" (150 mm)	358	80	210	150	50	0
204039	8" (200 mm)	385	80	260	200	50	0
204059	12" (300 mm)	438	80	365	300	50	0

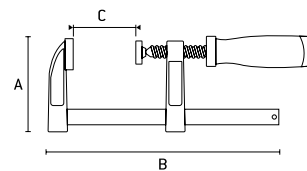

Mordentes com protetores plásticos
- Mordants with plastic protectors
- Mordazas con los protectores plásticos

- Corpo em aço carbono | Carbon steel body | Cuerpo en acero al carbono
- Cabo emborrachado | Rubberized cable | Mango de goma

Grampo Sargento Aperto Rápido

Staple Sergeant Quick Tight | Grapa Sargento Apriete Rápido



	KG	DIMENSÕES SIZE TAMAÑO (MM)			Quant. Min.		
		A	B	C			
205619	6" (150 mm)	184	150	280	150	96	12
205629	8" (200 mm)	196	155	335	200	96	12

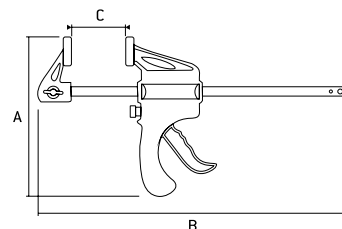

Mordentes com protetores plásticos
- Mordants with plastic protectors
- Mordazas con los protectores plásticos

- Aperto rápido | Quick Tight | Apriete rápido
- Ideal para fixar peças em processos de colagem, montagem de móveis entre outros | Ideal for securing parts in bonding processes, assembling furniture among others | Ideal para fijar piezas en procesos de pegado, montaje de muebles entre otros
- Grampo em plástico rígido ABS de alta resistência | High tensile ABS plastic clamp | Clip de plástico rígido ABS de alta resistencia
- Não usar para sustentação de peças | Do not use for parts | No utilizar para la ayuda de piezas

Grampo Multiuso para Marceneiro

Multipurpose Clip for Handyman | Grapa Multiuso para carpintero



	KG	DIMENSÕES SIZE TAMAÑO (MM)			Quant. Min.	
		A	B	C		
2078255	3" (75mm)	40	83	33	200	0
2078455	4" (100mm)	50	115	42	200	0
2078655	6" (150mm)	84	160	70	100	0
2078855	9" (225mm)	99	205	82	100	0

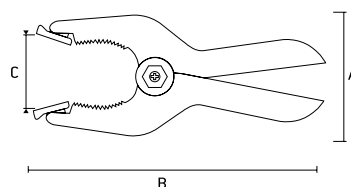

Grampo em Forma de C
C-shaped clip | Grapa en forma de C



DIMENSÕES SIZE TAMAÑO (MM)	DIMENSÕES SIZE TAMAÑO (MM)			Quant. Min.
	A	B	C	
206039 3" (75 mm)	90	170	75	24
206049 4" (100 mm)	110	215	100	24
206059 5" (125 mm)	125	250	125	24
206069 6" (150 mm)	130	280	150	24

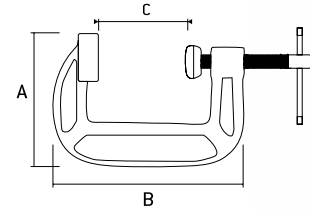

- Corpo de ferro reforçado | Reinforced iron body | Cuerpo de hierro reforzado
- Protetor dos mordentes de plástico | Plastic Cheek Protector | Protector de las mordazas de plástico

Grampo em Forma de C Ajustável
C-shaped clip Adjustable | Grapa en forma de C ajustable



DIMENSÕES SIZE TAMAÑO (MM)	DIMENSÕES SIZE TAMAÑO (MM)			Quant. Min.
	A	B	C	
206109 2" - 3" (50 - 75 mm)	80	130	75	48
206129 3" - 6" (75 - 150 mm)	95	170	150	24
206149 4" - 7" (100 - 175 mm)	110	195	175	12



Ajuste de Tamanho
- Size Adjustment
- Ajuste de tamaño

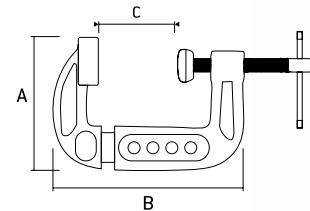

- Corpo de ferro reforçado | Reinforced iron body | Cuerpo de hierro reforzado
- Fosfatizado | Phosphatized | Fosfatizado

Grampo em Forma de C Pintado
C-shaped clip Painted | Grapa en forma de C pintado



DIMENSÕES SIZE TAMAÑO (MM)	DIMENSÕES SIZE TAMAÑO (MM)			Quant. Min.
	A	B	C	
2065055 2" (50 mm)	73	110	50	120
2065355 3" (75 mm)	77	148	75	60
2065655 4" (100 mm)	87	170	100	60
2066255 6" (150 mm)	110	250	150	30
2066555 8" (200 mm)	140	315	200	16

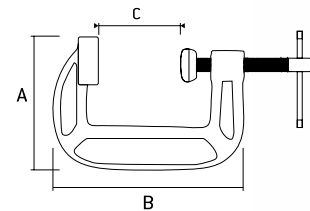

- Corpo de ferro reforçado | Reinforced iron body | Cuerpo de hierro reforzado

Conjunto de Grampos em Forma de C
Set of C-shaped Clips | Conjunto de grapas en forma de C



DIMENSÕES SIZE TAMAÑO (MM)	DIMENSÕES SIZE TAMAÑO (MM)			Quant. Min.
	A	B	C	
2067555 1" (25 mm)	45	55	25	50
2" (50 mm)	55	85	50	
3" (75 mm)	65	120	75	

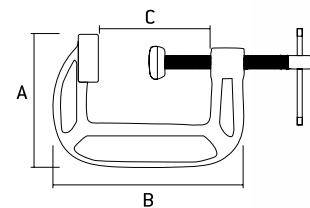

- Corpo de ferro reforçado | Reinforced iron body | Cuerpo de hierro reforzado
- Pintado | Painted | Pintado

Plainas Hobbie

Hobbie Planers | Llanas Hobbie



NOVO	Sparta	DIMENSÕES SIZE TAMAÑO (MM)			Quant. Min.	
		A	B	C		
2102055	nº 1	50	150	65	48	0
2102255	nº 2	53	190	75	36	0

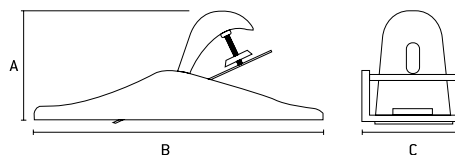

- Lamina temperada de aço Rápido | Tempered steel sheet Fast | Lamina templada de acero rápido
- Corpo de aço fundido | Casting steel body | Cuerpo de acero fundiendo
- Resistente a deformações | Resistant to deformation | Resistente a las deformaciones
- Para remover excesso de madeira nos lugares pequenos e difíceis de alcançar | To remove excess wood in places that are small and hard to reach | Para quitar exceso de madera en los lugares pequeños y difíciles de alcanzar

Plaina Profissional

Professional Plaine | Cepilladora profesional



NOVO	Sparta	DIMENSÕES SIZE TAMAÑO (MM)			Quant. Min.	
		A	B	C		
2107855	nº 3	135	240	60	15	0
2107955	nº 4	144	262	65	12	0

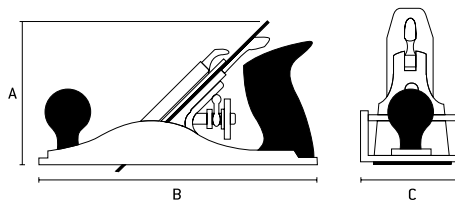

- Corpo de aço fundido | Casting steel body | Cuerpo de acero fundiendo
- Resistente a deformações | Resistant to deformation | Resistente a las deformaciones
- Base lisa | Smooth base | Base lisa
- Cabo Plástico | Plastic Cable | Cable de plástico

Machado cabo de fibra

Ax fiber cable | Machado cable de fibra



NOVO	Sparta	DIMENSÕES SIZE TAMAÑO (MM)			Quant. Min.	
		A	B	C		
2163755	600g	146	373	22	24	6
2163955	800g	167	409	27	12	6

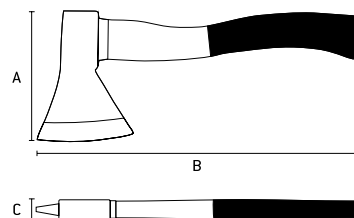

- Cabo Anatômico | Anatomical Cable | Mango Anatómico
- Aço forjado e temperado | Forged and tempered steel | Acero forjado y templado
- Ângulo de afiação 20 - 30% | Sharpening Angle 20 - 30% | Ángulo de afinación 20 - 30%



Caixa Plástica meia esquadria

Plastic housing half miter | Caja Plástica media escuadra



NOVO	2253055	KG	335g	DIMENSÕES SIZE TAMAÑO (MM)			Quant. Min.	
				A	B	C		
				100	345	50	36	0

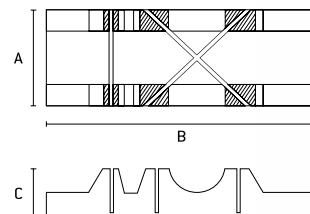

- Acompanha Serra (300mm) | Follow Saw (300mm) | Acompañante Sierra (300mm)
- Cortes em ângulos de 45° e 90° | Cuts at angles of 45° and 90° | Cortes en ángulos de 45° y 90°

Caixa Plástica para serra meia esquadria

Plastic box for half miter saws | Caja Plástica para sierra media escuadra



	225479	KG	363g	DIMENSÕES SIZE TAMAÑO (MM)			Quant. Min.	
				A	B	C		
				130	300	72	24	0

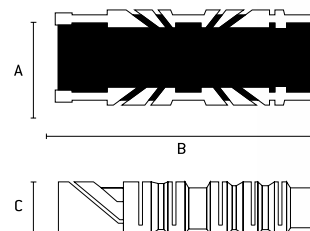

- Cortes em ângulos de 22,5°, 45° e 90° | Cuts at angles of 45° and 90° | Cortes en ángulos de 45° y 90°

Serra meia esquadria manual de precisão

Precision half-miter saw | Sierra media escuadra manual de precisión



	227329	KG	2.250g	DIMENSÕES SIZE TAMAÑO (MM)		Quant. Min.	
				A	B		
				215	420	4	0

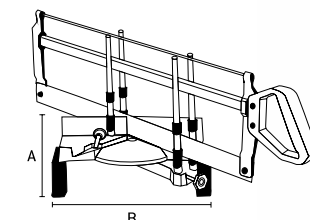

- Permite cortes precisos em planos horizontais e verticais | Allows precise cuts in horizontal and vertical planes | Permite cortes precisos en planos horizontales y verticales

Serra meia esquadria manual de precisão

Precision half-miter saw | Sierra media escuadra manual de precisión



	227409	KG	4.150g	DIMENSÕES SIZE TAMAÑO (MM)		Quant. Min.		
				A	B			
				170	550	160	4	0

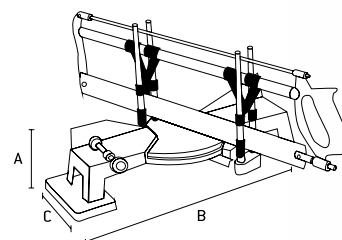

- Permite cortes precisos em planos horizontais e verticais | Allows precise cuts in horizontal and vertical planes | Permite cortes precisos en planos horizontales y verticales
- Com inclinação da lâmina | With blade tilt | Con inclinación de la hoja

Serrote de costa para madeira 12 TPI - 14"

Wood sawing saw 12 TPI | Serrucho de costa para madera 12 TPI



			DIMENSÕES SIZE TAMAÑO (MM)		
231489	14" (350mm)	398g	A	24	6

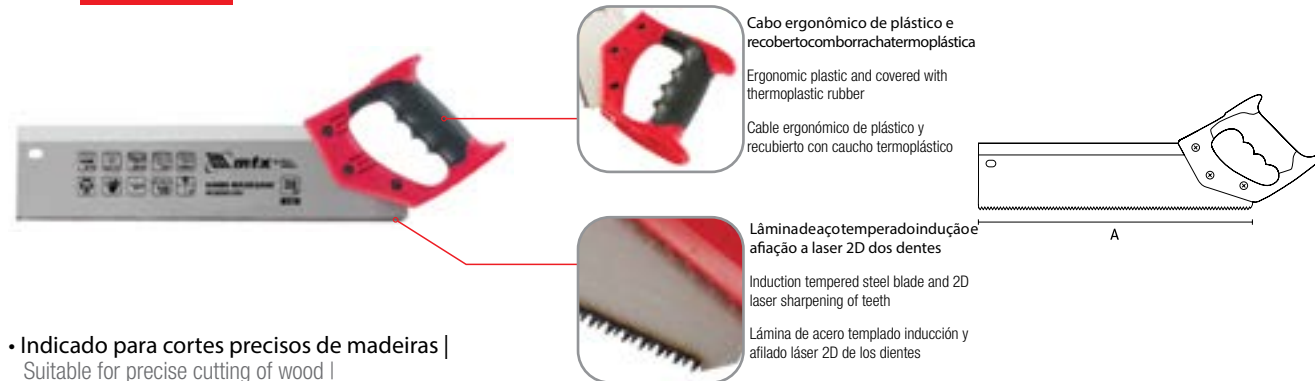

Cabo ergonómico de plástico e recoberto com borracha termoplástica

Ergonomic plastic and covered with thermoplastic rubber

Cable ergonómico de plástico y recubierto con caucho termoplástico

Lâmina de aço temperado indução e afiação a laser 2D dos dentes

Induction tempered steel blade and 2D laser sharpening of teeth

Lámina de acero templado inducción y afilado láser 2D de los dientes

- Indicado para cortes precisos de madeiras | Suitable for precise cutting of wood | Indicado para cortes precisos de maderas
- Para ser usado com a caixa meia esquadria (não acompanha) | To be used with half miter box (not attached) | Para ser utilizado con la caja media escuadra (no acompañada)

Serrote para gesso/Drywall

Plaster saw/drywall | Serrucho para yeso / Drywall



			DIMENSÕES SIZE TAMAÑO (MM)		
233929	7" (180 mm)	198g	A	36	12

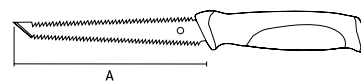

- Lâmina de aço temperado | Hardened steel blade | Lámina de acero templado
- 9 dentes por polegada | 9 teeth per inch | 9 dientes por pulgada
- Dupla afiação | Double edging | Doble afilado
- Ponta afiada para furo inicial | Sharp tip for initial hole | Punta afilada para el agujero inicial
- Linha dupla de corte | Double cutting line | Línea doble de corte

Serrote para madeira

Miter Saw Blade | Lámina para sierra media escuadra



		DIMENSÕES SIZE TAMAÑO (MM)		
235499	16" (400 mm)	A	24	6
235509	18" (450 mm)	450	24	6
235519	20" (500 mm)	500	24	6
235799	22" (550mm) black series	550	24	6

• 235499 | 235509 | 235519



235799
• black series

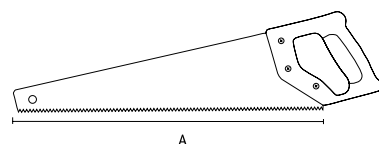

- Lâmina de aço com revestimento teflon | Teflon coated steel blade | Lámina de acero con revestimiento teflón
- 7-8 dentes por polegada com afiação a laser 3D | 7-8 teeth per inch with 3D laser sharpening | 7-8 dientes por pulgada con afilado láser 3D
- Cabo ergonómico de plástico e recoberto com borracha termoplástica | Ergonomic plastic cable and covered with thermoplastic rubber | Cable ergonómico de plástico y recubierto con caucho termoplástico

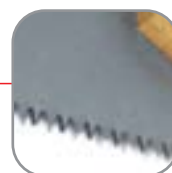

Tripla afiação a laser 3D Corte fácil e rápido nos 2 sentidos

Triple 3D laser sharpening Quick and easy cutting in 2 directions

Triple afilado láser 3D Corte fácil y rápido en los 2 sentidos

Serrote com cabo de madeira

Hacksaw with wooden handle | Sierra con cable de madera



AUTO SERVIÇO



novo	DIMENSÕES SIZE TAMAÑO (MM)	Quant. Min.		
		A	Quant. Min.	Quant. Min.
2318555	16" (400 mm)	400	48	4
2318755	18" (450 mm)	450	48	6
2318955	20" (500 mm)	500	48	6

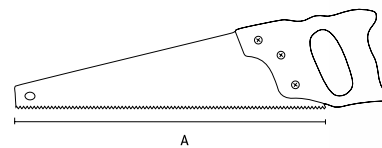

- Lâmina de aço | Steel blade | Lámina de acero
- Lâmina com régua | Blade with ruler | Lámina con regla
- 6 dentes por polegada temperados | 6 teeth per inch tempered | 6 dientes por pulgada templados

Serrote para gesso/drywall cabo de madeira

Plastersaw/drywall wooden cable | Serrucho para yeso/Drywall mango de madera



novo	DIMENSÕES SIZE TAMAÑO (MM)	Quant. Min.		
		A	Quant. Min.	Quant. Min.
2339055	7" (180 mm)	320	120	0

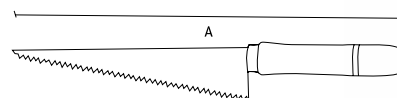

- Indicado para cortar gesso e drywall em geral | Suitable for cutting plaster and drywall in general | Indicado para cortar yeso y drywall en general
- Lâmina de aço carbono | Carbon Steel Blade | Lámina de acero al carbono

Formão cabo plástico

Plastic cable chisel | Cíncel mango de plástico



novo	DIMENSÕES SIZE TAMAÑO (MM)	Quant. Min.				
		A	B	Quant. Min.		
2440555	1/4"	6	215	93g	120	0
2440755	3/8"	10	233	100g	120	0
2441055	1/2"	12	233	120g	120	0
2441755	5/8"	16	250	135g	120	0
2442055	23/32"	18	245	137g	60	0
2442555	1"	24	250	148g	60	0
2443555	1.1/4"	32	257	182g	60	0
2444055	1.1/2"	38	258	267g	60	0

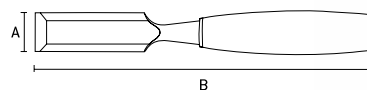

- Lâmina de aço carbono temperado | Tempered carbon steel blade | Lámina de acero al carbono templado
- Cabo plástico resistente | Heavy Duty Plastic Cable | Mango plástico resistente

Formões cabo plástico com borracha

Plastic Rubber Cable Chisel | Formones mango de plástico con caucho



CrV Alta Qualidade

HRc 60

AUTO SERVIÇO



novo	DIMENSÕES SIZE TAMAÑO (MM)	Quant. Min.				
		A	B	Quant. Min.		
245019	1/4"	6	330	230g	50	0
245059	3/8"	10	330	244g	50	0
245079	1/2"	12	330	260g	50	0
245119	5/8"	16	330	260g	50	0
245139	23/32"	18	330	280g	50	0
245169	7/8"	22	330	300g	50	0
245189	1.1/32"	26	330	310g	50	0
245219	1.1/4"	32	330	340g	50	0
245259	1.1/2"	38	330	360g	50	0

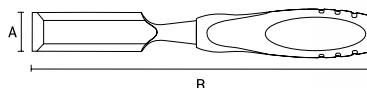

- Lâmina de aço CrV de alta resistência para absorção de impactos | High strength CrV steel blade for impact absorption | Lámina de acero CrV de alta resistencia para absorción de impactos
- Cabo anatômico de plástico com borracha termoplástica | Anatomical plastic cable with thermoplastic rubber | Mango anatómico de plástico con caucho termoplástico

Jogo de Formões

Chisels set | Juego de Formones

CrV
Alta
Qualidade

HRC
60

BLISTER



244329	1/4" 1/2" 23/32" 15/16"	DIMENSÕES SIZE TAMAÑO (MM)		16	4
		A	B		
		6	320		
		12	320		
		18	320		
		24	320		

4
peças
parts | piezas

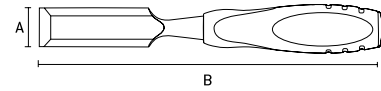

- Lâmina de aço especial de alta resistência para absorção de impactos | High strength special steel blade for impact absorption | Lámina de acero especial de alta resistencia para absorción de impactos
- Cabo anatômico de plástico com borracha termoplástica | Anatomical plastic cable with thermoplastic rubber | Cable anatómico de plástico con caucho termoplástico

Jogo de formões para entalhador

Chisels set | Juego de cinceles



2461655	140g	DIMENSÕES SIZE TAMAÑO (MM)			72	12
		A	B	C		
		189	270	20		

13
peças
parts | piezas

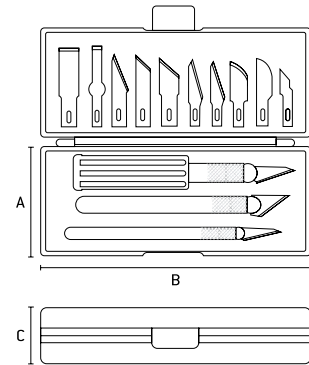

- Lâmina de aço | Steel Blade | Lámina de acero
- Cabo plástico | Plastic cable | Cable de plástico
- Embalagem: Caixa Plástica | Packing: Plastic Box | Embalaje: Caja Plástica

Pé de cabra

Wrecking Bar | Barreta Sacaclavos



HRC
42



2522655	24" (600 mm)	1kg	DIMENSÕES SIZE TAMAÑO (MM)		12	0
			A	B		
2522855	36" (900 mm)	1.398g	14	900	12	0

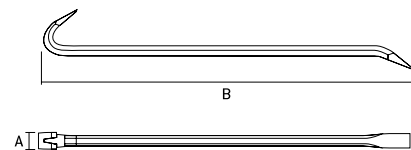

- Corpo sextavado | Hexagonal body | Cuerpo hexagonal
- Aço forjado | Forged steel | Acero forjado
- Para retirar pregos, desmontar caixarias, casas de madeiras | To remove nails, disassemble boxes, wooden houses | Para retirar clavos, desmontar cajeros, casas de madera

Pé de cabra

Wrecking Bar | Barreta Sacaclavos



HRC
44



252339	24" (600 mm)	1960g	DIMENSÕES SIZE TAMAÑO (MM)		6	0
			A	B		
			45	600		

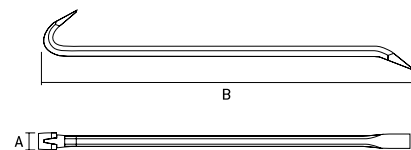

- Corpo sextavado pintado | Painted hexagonal body | Cuerpo hexagonal pintado
- Aço forjado | Forged steel | Acero forjado
- Para retirar pregos, desmontar caixarias, casas de madeiras | To remove nails, disassemble boxes, wooden houses | Para retirar clavos, desmontar cajeros, casas de madera



MEDICÇÃO

MEASUREMENT | MEDICIÓN

FERRAMENTAS DE MEDICÇÃO

MEASURING'S TOOLS
HERRAMIENTAS DE MEDICIÓN

As ferramentas de medição GROSS, MTX e Sparta proporcionam precisão ao trabalho a ser desenvolvido. Utilizando matérias primas de qualidade as ferramentas tem um ótimo desempenho e proporcionam um excelente resultado tanto para profissionais quanto para amadores.

The GROSS, MTX and Sparta measuring tools give precision to the work to be done. Using quality raw materials the tools have a great performance and provide an excellent result for both professionals and amateurs.

Las herramientas de medición GROSS, MTX y Sparta proporcionan precisión al trabajo a desarrollar. Utilizando materias primas de calidad las herramientas tiene un óptimo rendimiento y proporciona un excelente resultado tanto para profesionales como para aficionados.

SIMBOLOGIA



CÓDIGO
CODE



CARACTERÍSTICAS
Technical Features



PESO DA PEÇA
Part Weight
Peso de la Pieza



CAIXA MASTER
BoxMaster | Caja Máster



QUANT. MINÍMA
Quant. Minimum
Cantidad Mínima



Trena

Trains | Cinta Métrica

AUTO SERVIÇO



NOVO	KG	DIMENSÕES SIZE TAMAÑO (MM)			Quant. Min.		
		A	B	C			
3131155	3m x 16mm	134g	65	65	16	120	12
3131255	5m x 18mm	203g	70	70	18	120	12
3131455	10m x 25mm	438g	95	95	25	72	6
3130255	3m x 19mm	100g	65	65	19	120	12
3130355	5m x 25mm	242g	75	75	25	120	12
3130455	7,5m x 25mm	300g	80	80	25	60	6
3130555	10m x 25mm	395g	95	95	25	60	6



3130255
3130355
3130455
3130555

- estojo plástico | plastic case | caja de plástico
- graduação mm/pol. | graduation mm / in. | graduación mm / pulg.



3131155
3131255
3131455

- estojo emborrachado | rubbery | recubierto de goma
- graduação mm | graduation mm | graduación mm

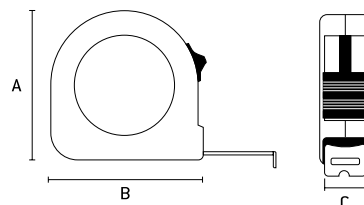

- Fita de aço | Steel strip | Cinta de acero
- Botão de trava da fita | Ribbon lock button | Botón de bloqueo de cinta
- Clipe metálico para cinto | Metal clip for belt | Clip metálico para cinturón
- Alça de nylon para transporte | Nylon carrying handle | Alza de nylon para transporte
- Gancho auto ajustável da fita | Auto Adjustable Ribbon Hook | Gancho auto ajustable de la cinta
- Embalagem: encartelado | Packing: Incarcerated | Embalaje: embalado

Trena

Trains | Cinta Métrica

AUTO SERVIÇO



NOVO	KG	DIMENSÕES SIZE TAMAÑO (MM)			Quant. Min.		
		A	B	C			
310169	3m x 16mm	117g	65	65	13	120	12
310179	5m x 19mm	200g	70	70	19	120	12
310189	7,5m x 25mm	340g	80	80	25	72	6
3100455	3m x 19mm	108g	65	65	19	120	12
3100555	5m x 25mm	250g	70	70	25	120	12
3100655	7,5m x 25mm	317g	80	80	25	60	6
3100055	10m x 25mm	417g	95	95	25	60	6



310169
310179
310189

- estojo plástico | plastic case | caja de plástico
- graduação mm | graduation mm | graduación mm



3100455
3100555
3100655
3100055

- estojo emborrachado | rubbery | recubierto de goma
- imantado | magnetized | magnetizado
- graduação mm/pol. | graduation mm / in. | graduación mm / pulg.

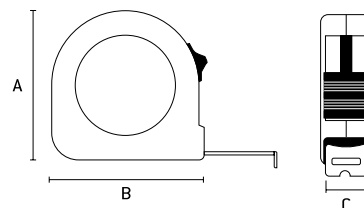

- Fita de aço | Steel strip | Cinta de acero
- Estojo Anatômico | Anatomical Case | Estuche Anatómico
- 3 Botões de trava da fita | 3 Ribbon lock buttons | 3 Botones de bloqueo de cinta
- Clipe metálico para cinto | Metal clip for belt | Clip metálico para cinturón
- Alça de nylon para transporte | Nylon carrying handle | Alza de nylon para transporte
- Gancho auto ajustável da fita | Auto Adjustable Ribbon Hook | Gancho auto ajustable de la cinta
- Embalagem: encartelado | Packing: Incarcerated | Embalaje: embalado

Trena Longa

Long Trains | Cinta Métrica Larga



NOVO	KG	DIMENSÕES SIZE TAMAÑO (MM)			Quant. Min.		
		A	B	C			
3143055	20m x 12,5mm	375g	145	240	22	40	0
3143555	30m x 12,5mm	468g	145	255	22	40	0
3144055	50m x 12,5mm	700g	170	260	22	20	0

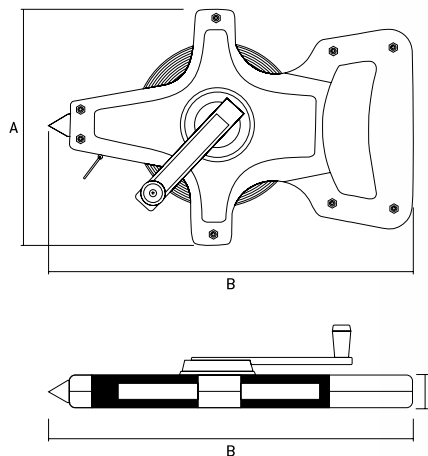

- Corpo de plástico resistente | Sturdy plastic body | Cuerpo de plástico resistente
- Ponta para fixar no terreno | Fixing point on the ground | Punta para fijar sobre el terreno
- Fita de PVC milimetrada | Millimeter PVC tape | Cinta de PVC milimétrica
- Largura da Fita de 12,5mm | 12,5mm Width Thickness | Ancho de la cinta de 12,5mm
- Resistente a umidade e variações de temperatura | Resistant to moisture and temperature variations | Resistente a la humedad y variaciones de temperatura
- Manivela para recolhimento da fita | Crank for tape pickup | Manivela para la recogida de la cinta
- Clipe metálico na ponta da fita | Metal clip on the end of the ribbon | Clip metálico en la punta de la cinta
- Embalagem: caixa | Packing: Box | Embalaje: caja

Paquímetro Digital

Digital Caliper | Calibrador Digital



NOVO	KG	DIMENSÕES SIZE TAMAÑO (MM)			Quant. Min.		
		A	B	C			
316119	150mm	322g	90	245	25	50	10

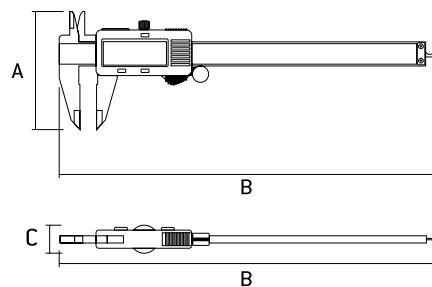

- Faixa de medição: (de 0" a 6") 0 a 150mm | Measuring range: (from 0 "to 6") 0 to 150mm | Rango de medición: (de 0 a 6) 0 a 150 mm
- Divisão de escala: ±0,01mm / 0,0005 - 1/64" | Accuracy: 0.01mm / 0.0005 - 1/64 " | Precisión: 0,01mm / 0,0005 - 1/64 "
- Bateria 2x 1,5V - SR44 | 2x 1.5V Battery - SR44 | Batería 2x 1,5V - SR44
- Medição fácil e com precisão | Easy and accurate measurement | Medición fácil y con precisión
- Indicado para medições internas e externas | Indicated for internal and external measurements | Indicado para mediciones internas y externas
- Embalagem: caixa plástica | Packing: plastic box | Embalaje: caja plástica

Paquímetro Universal
Universal Caliper | Calibrador Universal



	3163159	3163259	6"/150mm	8"/200mm	306g	431g	DIMENSÕES SIZE TAMAÑO (MM)			50	50	10	10
							A	B	C				
							88	245	20				

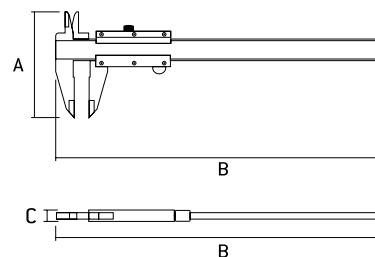

- Divisão de escala $\pm 0,02$ mm | Scale division ± 0.02 mm | División de escala $\pm 0,02$ mm
- Faixa de medição: milímetros | Measuring range: millimeters | Rango de medición: milímetros
- Quadrimensional | Four dimensions | Cuatro dimensiones
- Cursor Monobloco | Monobloc Cursor | Cursor Monobloco
- Embalagem: caixa plástica | Packing: plastic box | Embalaje: caja plástica

Micrômetro
Micrometer | Micrómetro



	3172559	3175059	3177559	3170059	0 - 25 mm	25 - 50 mm	50 - 75 mm	75 - 100mm	303g	382g	580g	725g	DIMENSÕES SIZE TAMAÑO (MM)			50	50	5	5
													A	B	C				
														75	151	30			
														95	185	30			
														108	210	30			
														130	240	30			

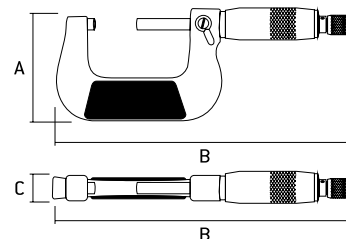

- Com catraca | With ratchet | Con carraca
- Fases de medição com metal duro | Measurement steps with carbide | Fases de medición con metal duro
- Uso Industrial | Industrial use | Uso Industrial
- Graduação de 0,01mm | Graduation of 0,01mm | Graduación de 0,01mm
- Embalagem: caixa plástica | Packing: plastic box | Embalaje: caja plástica

Esquadro
Square | Escuadro



	3234255	3234455	3234655	3235255	10"(250mm)	12"(300mm)	14"(350mm)	20"(500mm)	108g	132g	142g	183g	DIMENSÕES SIZE TAMAÑO (MM)			120	120	12	12
													A	B	C				
														130	250	15			
														130	300	15			
														150	350	15			
														150	500	15			

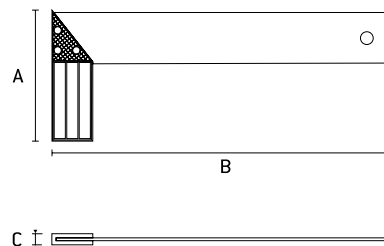

- Cabo de Alumínio | Aluminum Cable | Cable de aluminio
- Lâmina de Aço carbono | Carbon Steel Blade | Lámina de Acero de carbono

Esquadro Combinado (Uso Industrial)

Combined Square (Industrial Use) | Escuadrón Combinado (Uso Industrial)



3236755	12" (300mm)	292g	DIMENSÕES SIZE TAMAÑO (MM)			60	10
			A	B	C		
			140	362	17		

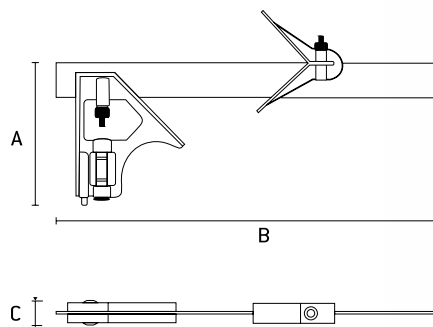

• Nível / Esquadro | Level / Square | Nivel / Escuadra

• Corpo / Base em alumínio fundido |

Cast aluminum body / base | Cuerpo / Base de aluminio fundido

• Régua deslizante de aço inox | Stainless steel sliding ruler | Riego deslizante de acero inoxidable

Esquadro de Aço carbono

Carbon Steel Square | Escuadra de acero carbono



323709	12" (300mm)	240g	DIMENSÕES SIZE TAMAÑO (MM)			72	0
			A	B	C		
			210	310	2		
323719	24" (600mm)	721g	410	601	2	24	0

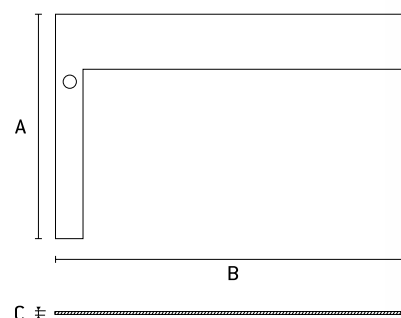

• Todo em aço carbono | All in carbon steel | Todo en acero al carbono

Esquadro de alumínio

Aluminum Square | Escuadra de aluminio



324719	10" (250mm)	158g	DIMENSÕES SIZE TAMAÑO (MM)			40	20
			A	B	C		
			135	250	15		
324729	12" (300mm)	188g	160	300	15	40	20
324739	14" (350mm)	225g	185	350	15	40	20
324749	16" (400mm)	263g	210	400	15	40	0

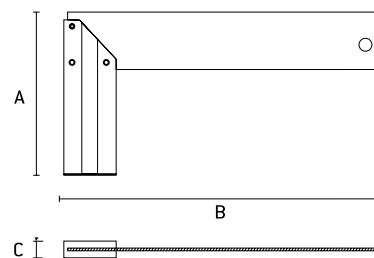

Nível de Alumínio 3 Bolhas

Level of Aluminum 3 Bubbles | Nivel de aluminio
3 burbujas



	Barcode	Clipboard	KG	DIMENSÕES SIZE TAMAÑO (MM)			Box	Quant. Min.
				A	B	C		
332179	10"(250mm)	100g	50	250	25	60	0	
332189	12"(300mm)	135g	50	300	25	60	0	
332199	14"(350mm)	150g	50	350	25	60	0	
332209	16"(400mm)	194g	50	400	25	60	0	
332239	24"(600mm)	259g	50	600	25	60	0	
332269	32"(800mm)	318g	50	800	25	60	0	
332299	40"(1000mm)	360g	50	1000	25	60	0	
332419	79"(2000mm)	733g	50	2000	25	30	0	

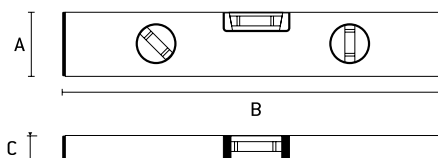

- Margem de erro permitida: 0,057° - 1 mm / 1m | Permitted error range: 0.057° - 1 mm / 1m | Margen de error permitido: 0,057° - 1 mm / 1m
- Alumínio | Aluminum | Aluminio
- Régua Graduada | Graduated Ruler | Régua Graduada
- 3 Bolhas | 3 Bubbles | 3 Burbujas

Nível de Alumínio Reforçado

Level of Aluminum | Nivel de aluminio



	Barcode	Clipboard	KG	DIMENSÕES SIZE TAMAÑO (MM)			Box	Quant. Min.
				A	B	C		
340049	16"(400mm)	333g	60	420	25	60	0	
340069	24"(600mm)	431g	60	615	25	48	0	
340089	32"(800mm)	553g	60	815	25	36	0	
340109	40"(1000mm)	687g	60	1020	25	36	0	

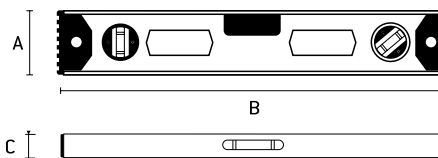

- Margem de erro permitida: 0,057° - 1 mm / 1m | Permitted error range: 0.057° - 1 mm / 1m | Margen de error permitido: 0,057° - 1 mm / 1m
- Alumínio | Aluminum | Aluminio
- 2 Bolhas / 1 Rotativa | 2 Bubbles / 1 Rotary | 2 Burbujas / 1 Rotativa
- Régua Graduada escala (mm e pol.) | Ruler graduated scale (mm and in.) | Regla Graduada escala (mm y pulg.)
- Reforçado | Reinforced | Reforzado



Bolha Rotativa
Rotary Bubble
Burbuja Rotativa

Nível 2 bolhas

Level 2 bubbles | Nivel 2 burbujas



NOVO	KG	DIMENSÕES SIZE TAMAÑO (MM)			Quant. Min.		
		A	B	C			
3510155	10"(250mm)	55g	47	250	17	60	0
3510255	12"(300mm)	75g	47	300	17	60	0
3510355	14"(350mm)	105g	47	350	17	60	0
3510455	16"(400mm)	125g	47	400	17	60	0
3510655	24"(600mm)	158g	47	600	17	60	0
3510855	32"(800mm)	193g	47	800	17	60	0
3511055	40"(1000mm)	233g	47	1000	17	30	0
	71"(1800mm)	500g	47	1800	17	30	0*
3512055	79"(2000mm)	380g	47	2000	17	30	0

- Margem de erro permitida: 0,057° - 1 mm / 1 m |

Permitted error range: 0.057° - 1 mm / 1m | Margen de error permitido: 0,057° - 1 mm / 1m

- Alumínio | Aluminum | Aluminio

- Régua Graduada | Graduated Ruler | Régua Graduada

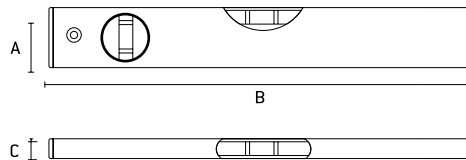

Nível de alumínio imantando

Level of aluminum magnetizing | Nivel de aluminio imantando



	KG	DIMENSÕES SIZE TAMAÑO (MM)			Quant. Min.		
		A	B	C			
347049	16"(400mm)	305g	60	400	25	40	0
347069	24"(600mm)	415g	60	600	25	40	0
347089	32"(800mm)	545g	60	800	25	40	0
347109	40"(1000mm)	640g	60	1000	25	40	0*
347209	80"(2000mm)	1225g	60	2000	25	20	0



- Margem de erro permitida: 0,057° - 1 mm / 1 m |

Permitted error range: 0.057° - 1 mm / 1m | Margen de error permitido: 0,057° - 1 mm / 1m

- Alumínio | Aluminum | Aluminio

- Imantado | Magnetized | Magnetizado

- 3 Bolhas | 3 Bubbles | 3 Burbujas

- Com 1 espelho | With 1 mirror | Con 1 espejo

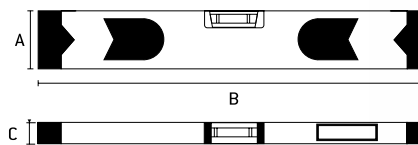

Nível Plástico imantado

Plastic Level magnetized | Nivel Plástico imantado



	KG	DIMENSÕES SIZE TAMAÑO (MM)			Quant. Min.		
		A	B	C			
3461155	9 1/2"(230mm) torpedo	93g	15	230	40	120	20

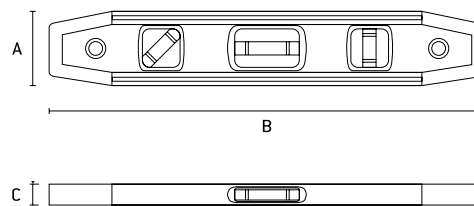

- 3 Bolhas | 3 Bubbles | 3 Burbujas

- Formato Torpedo | Torpedo shape | Formato de Torpedo

- Imantado | Magnetized | Magnetizado

Nível a laser com prumo

Plummet and laser level | Prumo y nivel láser



DIMENSÕES | SIZE | TAMAÑO (MM)

A	B	C
91	125	46



350069

125g

91

125

46

60

0

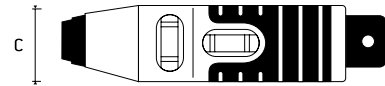
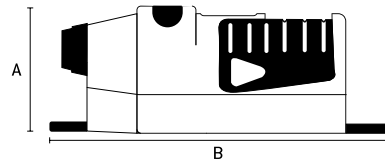

02 Bolhas de nivelamento
02 leveling bubbles
burbujas de nivelación

- Marcação de prumo | Plumb Tagging | Marcado de plomado
- Utilizados para verificar plano verticais e horizontais | Used to check vertical and horizontal planes | Utilizados para comprobar plan vertical y horizontal
- Embalagem: Plástica | Packing: Plastic | Embalaje: Plástico

Nível a laser esquadro

Level laser square | Nivel láser escuadra



DIMENSÕES | SIZE | TAMAÑO (MM)

A	B	C
205	240	57



350079

243g

205

240

57

20

0



Aplicação
Application
Aplicación



2 ventosas para fixação
2 suction cups
2 ventosas para fijación

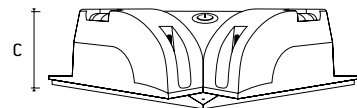
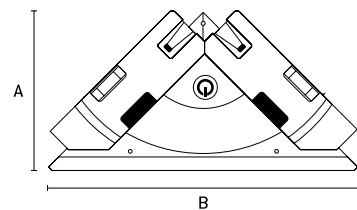

- Tipo de Marcação: Linha de ângulos | Marking Type: Line of Angles | Tipo de marcado: Línea de ângulos
- 03 Bolhas | 03 Bubbles | 03 Burbujas
- Embalagem: Caixa | Packing: Carton | Embalaje: Caja

Nível a laser com tripé

Laser Level with Tripod | Nivel láser con trípode



DIMENSÕES | SIZE | TAMAÑO (MM)

A	B	C
124	242	30



350209

10m

195g

124

242

30

40

10

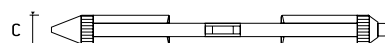
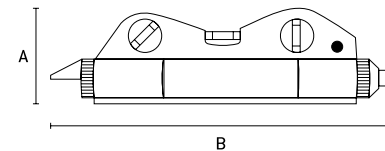

- Magnético | Magnetic | Magnético
- Altura do tripé 150mm | Tripod height 150mm | Altura del trípode 150mm
- 3 Bolhas | 3 Bubbles | 3 Burbujas
- Embalagem: Blister | Packing: Blister | Embalaje: Blister

Prumo / Nível a Laser com tripé

Plumb / Laser Level with Tripod | Prumo / Nivel a láser con trípode



350229	213g	DIMENSÕES SIZE TAMAÑO (MM)			40	10*
		A	B	C		

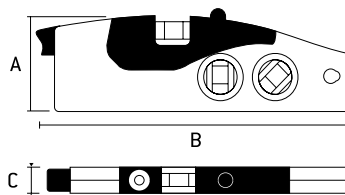

Magnético
Magnetic
Magnético

- Magnético | Magnetic | Magnético
- Marcação em vertical e horizontal | Cross marking | Marcado en cruz
- Altura do tripé 220mm | Tripod height 220mm | Altura del trípode 220mm
- 4 bolhas | 4 Bubbles | 4 Burbujas
- Embalagem: Blister | Packing: Blister | Embalaje: Blister
- Alcance da marcação em cruz 10 metros | Cross-marking range 10 meters | Alcance del marcado en cruz 10 metros
- Alcance da marcação em ponto 50 metros | Point-marking range 50 meters | Alcance del marcado en punto 50 metros

Nível a laser para furação

Level laser square | Nivel láser escuadra



350409	5m	402g	DIMENSÕES SIZE TAMAÑO (MM)			20	0
			A	B	C		

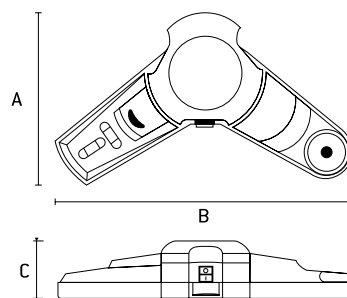

- Marcação para furação | Drilling marking | Marcado para perforación
- Coletor de pó | Dust collector | Colector de polvo
- 2 Bolhas | 2 Bubbles | 2 Burbujas
- Diâmetro máximo 10mm | Maximum diameter 10mm | Diámetro máximo 10mm
- Ideal para acabamentos de instalações | Ideal for finishing installations | Ideal para acabados de instalaciones
- Protetor plástico na parte inferior | Plastic protector on the bottom | Protector plástico en la parte inferior
- Embalagem: Caixa | Packing: Carton | Embalaje: Caja



Aplicação
Application
Aplicación

Tripé

Tripod | Trípode



350909

420 - 1260mm

910g

420 a 1260mm

10

0

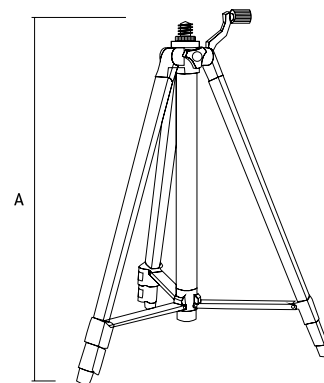

- Alumínio | Aluminum | Aluminio
- Ajuste de altura | Height Adjustment | Ajuste de altura
- Elevação 420 - 1260 mm | Elevation 420 - 1260 mm | Elevación 420 - 1260 mm
- Rosca 5/8" | Thread 5/8" | Rosca 5/8"
- Acessório para produtos: 350339 e 350359 | Accessory for products: 350339 and 350359 | Accesorio para productos: 350339 y 350359

Nível de canto

Level of corner | Nivel de esquina



3482055

135g

98

155

100

20

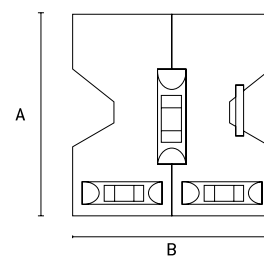

- Plástico | Plastic | Plástico
- Magnético | Magnetic | Magnético
- 3 Bolhas de medição | 3 Measuring bubbles | 3 Burbujas de medición
- Embalagem: Caixa | Packing: Carton | Embalaje: Caja



Aplicação
Application
Aplicación

Nível a Laser de alta precisão com tripé
High Precision Laser Level with Tripod | Nivel láser de alta precisión con trípode



			DIMENSÕES SIZE TAMAÑO (MM)			
350339	10m	2863g	A	B	4	0

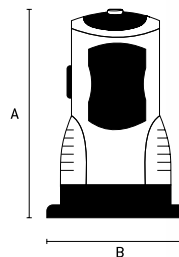

Distância aproximada de operação:
~10m
Approximate operating distance: ~
10m
Distancia aproximada de
funcionamiento: ~ 10m
Potência do laser: 1nW
Laser power: 1nW
Potencia del laser: 1nW
Comprimento da onda do laser:
650nm
Laser wave length: 650nm
Longitud de la onda del laser: 650nm
Alimentação: 3 Pilhas AA 1,5V
Power: 3 AA batteries 1,5V
Alimentación: 3 pilas AA 1,5V



Maleta com o Nível e os acessórios
Suitcase with the Levels of the Accessories
Maleta con Nivel e os acessórios



Base giratória (regulável) 360°
Swivel base (adjustable) 360°
Base giratoria (ajustable) 360°

- Alta precisão de onda horizontal e vertical: ~2nW/m | High horizontal and vertical wave precision: ~ 2nW / m | Alta precisión de onda horizontal y vertical: ~ 2nW / m
- Auto nivelamento | Auto leveling | Auto nivelación
- Marcação em cruz | Cross marking | Marcado en cruz
- Óculos de proteção | Protective goggles | Anteojos de protección
- Altura tripé 1100m, rosca 5/8" | Tripod height 1100m, thread 5/8 " | Altura de trípode 1100m, rosca 5/8 "
- 3 bolhas | 3 bubbles | 3 burbujas
- Embalagem: Caixa Plástica | Packing: Plastic Box | Embalaje: Caja Plástica

NÍVEL A LASER 5 LINHAS

5 LEVEL LASER LEVEL | NIVEL A LASER 5 LÍNEAS



350359



10mt



2333g

DIMENSÕES | SIZE | TAMANHO (mm)

A

B



6



Quant. Min. 1



DESCRIÇÃO

- Alcance: 10m ambientes internos
- Aviso sonoro de desnivelamento
- Possui 3 bolhas de nivelamento
- Utiliza 3 Pilhas AA (incluso)
- Fonte Bivolt (incluso)
- Óculos para melhor visualização do laser (incluso)
- Acompanha maleta para transporte

DESCRIPTION

- Range: 10m indoor environments
- Unbalanced sound warning
- It has 3 leveling bubbles
- Uses 3 AA batteries (included)
- Bivolt Source (included)
- Glasses for better visualization of the laser (included)
- Carrying case included

DESCRIPCIÓN

- Alcance: 10m ambientes internos
- Advertencia sonora de desnivel
- Tiene 3 burbujas de nivelación
- Utiliza 3 pilas AA (incluidas)
- Fuente Bivolt (incluido)
- Gafas para una mejor visualización del láser (incluido)
- Acompaña maletín para transporte

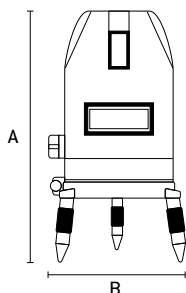

LIGA E DESLIGA

- ON AND OFF
- LIGA Y APAGADO

AJUSTE PRECISO 360°

- 360° PRECISION ADJUSTMENT
- 360° PRECISION ADJUSTMENT

- Comprimento da onda do laser: 650nm
 - Laser wave length: 650nm
 - Longitud de la onda del laser: 650nm
- Nível de Precisão +/- 0,5mm/5m
 - Accuracy Level +/- 0.5mm / 5m
 - Nivel de precisión +/- 0,5mm / 5m
- Desvio do angulo direito 90° a +/- 1°
 - Deviation from right angle 90° to +/- 1°
 - Desviación del ángulo derecho 90° a +/- 1°



4 SAÍDAS DE LINHAS VERTICAIS

- 4 OUTPUTS OF VERTICAL LINES
- 4 SALIDAS DE LÍNEAS VERTICALES

SAÍDA DE LINHA HORIZONTAL

- HORIZONTAL LINE OUTPUT
- SALIDA DE LÍNEA HORIZONTAL

BASE AJUSTÁVEL

- ADJUSTABLE BASE
- BASE AJUSTABLE

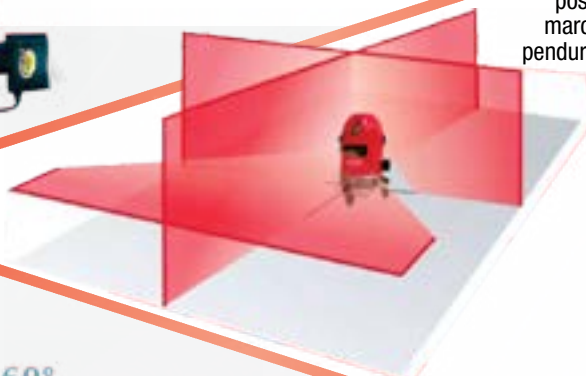

- **Nível Laser MTX** projeta em qualquer superfície, rápido e sem riscar.
- A ferramenta é utilizada para calibrar as posições corretas relativas dos objetos na distância, marcando as bases. Perfeito para instalar prateleiras, pendurar quadros, colocar portas, azulejos, janelas, etc.

- MTX Laser Level projects in any surface, fast and without scratching.
- The tool is used to calibrate the relative positions of objects in the distance, marking the bases. Perfect for installing shelves, hang frames, put doors, tiles, windows, etc.

- Nivel láser MTX proyecta en cualquier superficie, rápido y sin rayar.
- La herramienta se utiliza para calibrar las las posiciones correctas relativas de los objetos en la distancia, marcando las bases. Perfecto para instalar estantes, colgar cuadros, colocar puertas, azulejos, ventanas, etc.

PAINEL FRONTAL

BOLHA DE NÍVEL ILUMINADO

- ILLUMINATED LEVEL BUBBLE
- BURBUJA DE NIVEL ILUMINADO

LINHA VERTICAL

- VERTICAL LINE
- LÍNEA VERTICAL

CLIQUE DUPLO PARA ACIONAMENTO DAS 4 LINHAS VERTICAIS

- DOUBLE CLICK FOR TRANSFER OF 4 VERTICAL LINES
- CLIQUE DOBLE PARA ACCIONAMIENTO DE LAS 4 LÍNEAS VERTICALES

INTENSIDADE DO LASER

- LASER INTENSITY
- INTENSIDAD DEL LÁSER

LINHA HORIZONTAL

- HORIZONTAL LINE
- LÍNEA HORIZONTAL

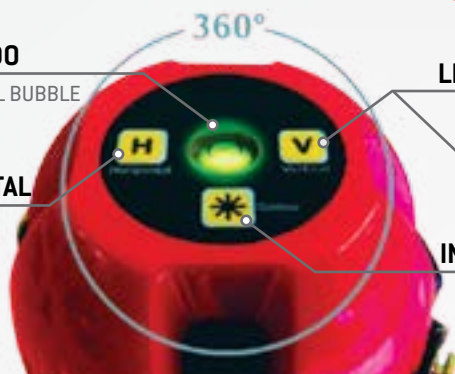



FERRAMENTAS DE MONTAGEM

ASSEMBLY'S TOOLS
HERRAMIENTAS DE MONTAJE

As ferramentas de montagem GROSS, MTX proporcionam a ergonomia apropriada ao trabalho a ser desenvolvido. Utilizando matérias primas de qualidade as ferramentas tem um ótimo desempenho e proporcionam um excelente resultado tanto para profissionais quanto para amadores. Toda a ferramenta é testada para realizar o trabalho com perfeição e confiança.

The GROSS, MTX assembly tools provide the appropriate ergonomics for the work to be done. Utilizing quality raw materials the tools have a great performance and provide an excellent result for both professionals and amateurs. The entire tool is tested to perform the job with perfection and confidence.

Las herramientas de montaje GROSS, MTX proporcionan la ergonomía apropiada al trabajo a ser desarrollado. Utilizando materias primas de calidad las herramientas tienen un óptimo desempeño y proporcionan un excelente resultado tanto para profesionales como para aficionados. Toda la herramienta se prueba para realizar el trabajo con la perfección y la confianza.

SIMBOLOGIA



CÓDIGO
CODE



CARACTERÍSTICAS
Technical Features



PESO DA PEÇA
Part Weight
Peso de la Pieza



CAIXA MASTER
Box Master | Caja Máster



QUANT. MINÍMA
Quant. Minimum
Cantidad Mínimo

Rebitador Manual Tipo Alicate

Manual Riveter Pliers Type | Rebajador Manual Tipo Alicate



Barcode	Length	Weight	DIMENSÕES SIZE TAMAÑO (MM)			Box	Quant. Min.
			A	B	C		
405159	225mm	542g	130	225	30	24	0
405249	250mm	583g	130	250	30	24	0



• 405159

• 405249

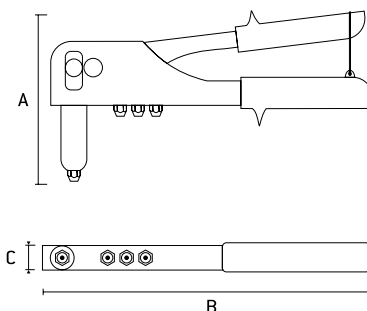

- Rebitos | Rivets | Remaches 2,4 | 3,2 | 4,0 | 4,8 mm
- Indicado para unir peças como: chapas, tubos, perfis através de rebites de repuxo | Suitable for joining parts such as: plates, pipes, profiles through fissure rivets | Indicado para unir piezas como: chapas, tubos, perfiles a través de remaches de repuesto
- Corpo em chapa de aço fundido | Body in cast steel sheet | Cuerpo en chapa de acero fundido
- Rebitos de alumínio e de aço | Aluminum and steel rivets | Rejillas de aluminio y de acero
- Embalagem: Blister | Packing: Blister | Embalaje: Blister

Rebitador Tipo Alicate

Riveter Pliers Type | Rebajador Tipo Alicate



Barcode	Length	Weight	DIMENSÕES SIZE TAMAÑO (MM)			Box	Quant. Min.
			A	B	C		
405279	250mm	725g	130	250	30	24	0
405339	263mm	738g	130	263	28	24	0



• 405279



Cabeça ajustável 0-90°
Adjustable head 0-90°
Cabeza ajustable 0-90°



• 405339



Cabeça giratória 0-360°
Swivel head 0-360°
Cabeza giratoria 0-360°

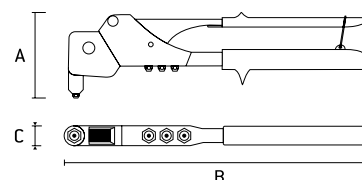
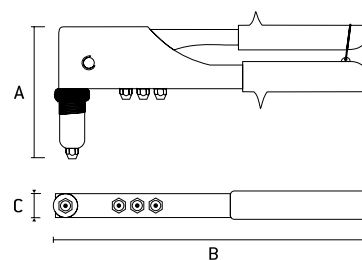

- Rebitos | Rivets | Remaches 2,4 | 3,2 | 4,0 | 4,8 mm
- Indicado para unir peças como: chapas, tubos, perfis através de rebites de repuxo | Suitable for joining parts such as: plates, pipes, profiles through fissure rivets | Indicado para unir piezas como: chapas, tubos, perfiles a través de remaches de repuesto
- Corpo em chapa de aço fundido | Body in cast steel sheet | Cuerpo en chapa de acero fundido
- Rebitos de alumínio e de aço | Aluminum and steel rivets | Rejillas de aluminio y de acero
- Embalagem: Blister | Packing: Blister | Embalaje: Blister

Rebitador Manual Tipo Alavanca

Manual Riveter Type Lever | Rebajador Manual Tipo Palanca



405359



500mm



2030g

DIMENSÕES | SIZE | TAMAÑO (MM)

A

B

C



10



0

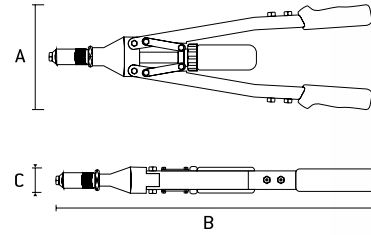

- Rebitos | Rivets | Remaches | 3,2 | 4,0 | 4,8 | 6,0 | 6,4 mm
- Indicado para unir peças como: chapas, tubos, perfis através de rebites de repuxo |
Suitable for joining parts such as: plates, pipes, profiles through fissure rivets |
Indicado para unir piezas como: chapas, tubos, perfiles a través de remaches de repuesto
- Embalagem: Caixa | Packing: Box | Embalaje: Caja

Rebitador Manual Tipo Alavanca

Manual Riveter Type Lever | Rebajador Manual Tipo Palanca



4053855



450 mm



930g

DIMENSÕES | SIZE | TAMAÑO (MM)

A

B

C



10



0

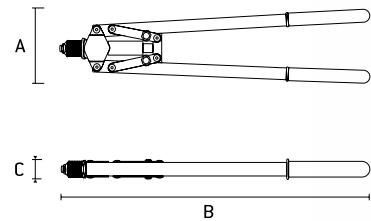

- Rebitos | Rivets | Remaches | 3,2 | 4,0 | 4,8 | 6,0 mm
- Indicado para unir peças como: chapas, tubos, perfis através de rebites de repuxo |
Suitable for joining parts such as: plates, pipes, profiles through fissure rivets |
Indicado para unir piezas como: chapas, tubos, perfiles a través de remaches de repuesto
- Embalagem: Caixa | Packing: Box | Embalaje: Caja



Grampeador e Pinador manual - Profissional

Stapler and Manual Pincher - Professional | Grapadora y Pinador manual - Profesional



BLISTER



409019	908g	DIMENSÕES SIZE TAMAÑO (MM)			24	Quant. Min.
		A	B	C		

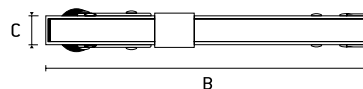
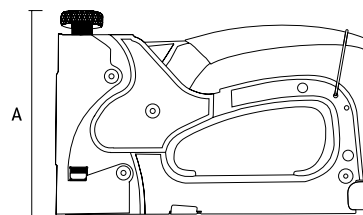

- Grampos e Pinos Tipo | Clamps and Pins Type | Grapas y Perros Tipo: 36, 140, 300, 500
- Para utilização em estofarias | For use on upholstery | Para uso en tapizados
- Ajuste de pressão | Pressure adjustment | Ajuste de presión
- Uso profissional | Professional use | Uso profesional
- Para grampos de 6 - 14mm | For 6 - 14mm clamps | Para grapas de 6 - 14mm
- Corpo em chapa de aço cromado | Chrome plated steel body | Cuerpo en chapa de acero cromado
- Embalagem: Blister | Packing: Blister | Embalaje: Blister
- Acompanha 50 Grampos | Accompany Clamps | Acompaña Clips
- Compartimento para 100 grampos Tipo 140, 95 grampos Tipo 36, 85 grampos Tipo 300 e 500

Grampeador Tapeceiro | Controle de Pressão

Stapler Upholsterer | Pressure Control | Grapadora Tapicería | Control de Presión



BLISTER



409029	650g	DIMENSÕES SIZE TAMAÑO (MM)			40	Quant. Min.
		A	B	C		

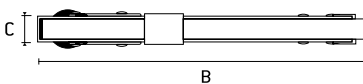
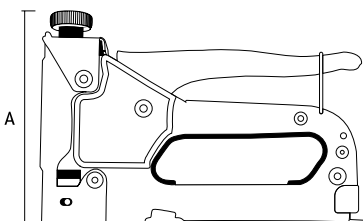

- Para utilização em estofarias | For use on upholstery | Para uso en tapizados
- Ajuste de pressão | Pressure adjustment | Ajuste de presión
- Para grampos tipo 53 de 4 - 14mm | For clamps type 53 in 4 - 14mm | Para grapas tipo 53 de 4 - 14mm
- Corpo em chapa de aço cromado | Chrome plated steel body | Cuerpo en chapa de acero cromado
- Embalagem: Blister | Packing: Blister | Embalaje: Blister
- Acompanha 50 Grampos | Accompany Clamps | Acompaña Clips
- Compartimento para 100 grampos Tipo 53

Grampeador Tapeceiro

Stapler Upholsterer | Grapadora Tapicería



BLISTER



409039	475g	DIMENSÕES SIZE TAMAÑO (MM)			40	Quant. Min.
		A	B	C		

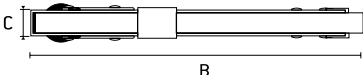
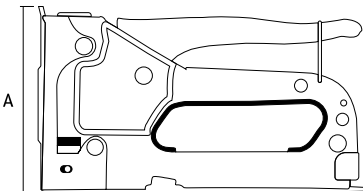

- Para utilização em estofarias | For use on upholstery | Para uso en tapizados
- Para grampos tipo 53 de 4-8 mm | For Type 53 Clips | Para grapas tipo 53
- Corpo em chapa de aço cromado | Chrome plated steel body | Cuerpo en chapa de acero cromado
- Embalagem: Blister | Packing: Blister | Embalaje: Blister
- Acompanha 50 Grampos | Accompany Clamps | Acompaña Clips
- Compartimento para 100 grampos Tipo 53

Grampeador Tapeceiro de Plástico

Stapler Upholsterer Plastic | Grapadora Tapicería de Plástico



409079



250g

DIMENSÕES | SIZE | TAMAÑO (MM)

A

B

C



80



20



BLISTER

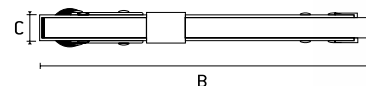
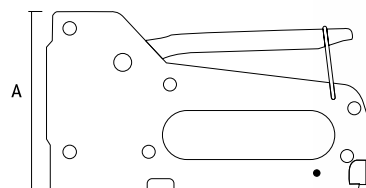

- Para utilização em estofarias | For use on upholstery | Para uso en tapizados
- 4 Para grampos tipo 53 de 4 - 8mm | For 4 - 8mm clamps | Para grapas de 4 - 8mm
- Embalagem: Blister | Packing: Blister | Embalaje: Blister
- Corpo Plástico | Plastic Body | Cuerpo Plástico
- Acompanha 50 Grampos | Accompany Clips | Acompaña Clips
- Compartimento para 100 grampos Tipo 53

Grampeador Tapeceiro Reforçado

Stapler Upholsterer Reinforced | Grapadora Tapicería reforzada



41000



605g

DIMENSÕES | SIZE | TAMAÑO (MM)

A

B

C



40



10*



BLISTER

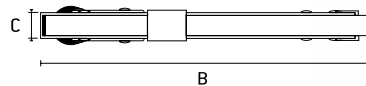
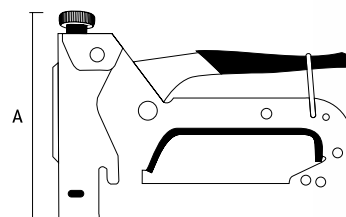

- Ajuste de Pressão | Pressure Adjustment | Ajuste de presión
- Cabo emborrachado | Rubberized cable | Cable de goma
- Corpo de metal reforçado | Reinforced metal body | Cuerpo de metal reforzado
- Grampo tipo 53 (4-14mm) | Type 53 clip (4-14mm) | Grapa tipo 53 (4-14mm)
- Embalagem: Blister | Packing: Blister | Embalaje: Blister

Grampeador Manual

Manual Stapler | Grapadora manual



4200355



950g



20



5



AUTO SERVIÇO



- Kit Contém | Kit Contains | Kit Contiene
- Grampeador (6-14mm) | Stapler (6-14mm) | Grapadora (6-14mm)
- Trena de 2mt x 13mm | Measuring tape 2 mt x 13mm | Trena de 2 mt x 13mm
- 500 grampos tipo 53 (8mm) | 500 cli ps type 53 (8mm) | 500 grapas ti po 53 (8mm)

Extrator de grampos
Staple Remover | Extractor de grapas



409129	universal	143g	DIMENSÕES SIZE TAMAÑO (MM)			84	42
			A	B	C		



BLISTER

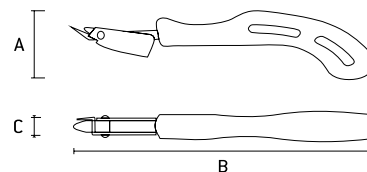

Grampos
Clamp | Grapa



411169	6 mm - tipo 53	6	11,3	0,7	300	0
411189	8 mm - tipo 53	8	11,3	0,7	300	0
411209	10 mm - tipo 53	10	11,3	0,7	240	0
411229	12 mm - tipo 53	12	11,3	0,7	180	0
411249	14 mm - tipo 53	14	11,3	0,7	180	0



• Tipo | Type 53

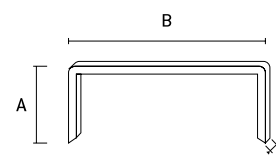

10,6

• Embalagem caixa com 1000 peças | Packing box with 1000 pieces | Embalaje caja con 1000 piezas

Grampos Temperados
Clamp | Grapa



412069	6 mm - tipo 53	6	11,3	0,7	300	0
412089	8 mm - tipo 53	8	11,3	0,7	300	0
412109	10 mm - tipo 53	10	11,3	0,7	240	0
412129	12 mm - tipo 53	12	11,3	0,7	180	0
412149	14 mm - tipo 53	14	11,3	0,7	180	0
413069	6 mm - tipo 140	6	10,6	1,25	200	0
413089	8 mm - tipo 140	8	10,6	1,25	180	0
413109	10 mm - tipo 140	10	10,6	1,25	150	0
413129	12 mm - tipo 140	12	10,6	1,25	120	0
413149	14 mm - tipo 140	14	10,6	1,25	120	0
414129	12 mm - tipo 36 U	12	7,74	1,25	150	0
414149	14 mm - tipo 36 U	14	7,74	1,25	120	0



• Tipo | Type 53



• Tipo | Type 140



• Tipo | Type 36 U

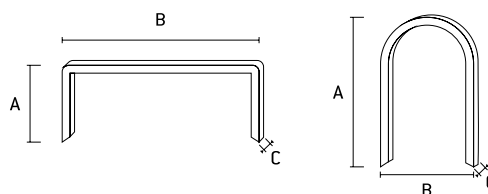

• Temperados | Tempered | Sazonado
• Embalagem caixa com 1000 peças | Packing box with 1000 pieces | Embalaje caja con 1000 piezas

Pinos para pinadores manuais
Staple Remover | Extractor de grapas



415109	10 mm - Tipo 300 T-VT	0,088g	DIMENSÕES SIZE TAMAÑO (MM)			250	0
			A	B	C		
415129	12 mm - Tipo 300 T-VT	0,105g	12	1,25	1	250	0
415149	14 mm - Tipo 300 T-VT	0,126g	14	1,25	1	200	0

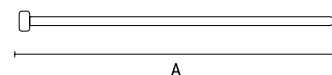

• Tipo | Type 300 T-VT
• Com Cabeça | With head | Con Cabeza
• Embalagem caixa com 1000 peças | Packing box with 1000 pieces | Embalaje caja con 1000 piezas

Rebites de repuxo

Flake rivets | Rejillas de repuesto



Código	Dimensões	Peso	DIMENSÕES SIZE TAMAÑO (MM)		Quant. Max.	Quant. Min.
			A	B		
406109	3,2 x 6 mm	0,050g	3,2	6	400	200
406209	3,2 x 8 mm	0,052g	3,2	8	400	200
406259	3,2 x 10 mm	0,052g	3,2	10	400	100
406279	3,2 x 12 mm	0,057g	3,2	12	400	100
406319	4,0 x 6 mm	0,070g	4,0	6	200	100
406329	4,0 x 8 mm	0,076g	4,0	8	200	100
406359	4,0 x 10 mm	0,078g	4,0	10	200	100
406409	4,0 x 12 mm	0,084g	4,0	12	200	100
406439	4,0 x 14 mm	0,090g	4,0	14	200	100
406459	4,0 x 16 mm	0,091g	4,0	16	200	100
406509	4,8 x 8 mm	0,110g	4,8	8	200	100
406559	4,8 x 10 mm	0,120g	4,8	10	200	100
406609	4,8 x 12 mm	0,125g	4,8	12	200	100
406639	4,8 x 14 mm	0,132g	4,8	14	100	50
406659	4,8 x 16 mm	0,143g	4,8	16	100	50

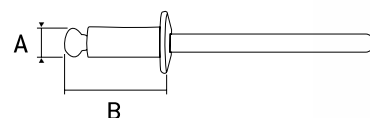

- Corpo Alumínio | Body Aluminum | Cuerpo Aluminio
- Embalagem: pacotes com 50 peças | Packing: packages with 50 pieces | Embalaje: paquetes con 50 piezas

Pinos para pinadores pneumáticos

Pines | Pinos



Código	Dimensões	Peso	DIMENSÕES SIZE TAMAÑO (MM)			Quant. Max.	Quant. Min.
			A	B	C		
576029	10 mm - 18GA - cx 5000 pçs	450g	10	1,25	1	20	0
576049	15 mm - 18GA - cx 5000 pçs	750g	15	1,25	1	20	0
576069	20 mm - 18GA - cx 5000 pçs	823g	20	1,25	1	20	0
576089	25 mm - 18GA - cx 5000 pçs	1075g	25	1,25	1	20	0
576109	30 mm - 18GA - cx 5000 pçs	1300g	30	1,25	1	20	0
576149	35 mm - 18GA - cx 5000 pçs	1500g	35	1,25	1	10	0
576169	40 mm - 18GA - cx 5000 pçs	1700g	40	1,25	1	10	0
576209	50 mm - 18GA - cx 5000 pçs	2020g	50	1,25	1	10	0

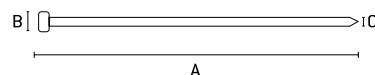

- Largura 1,25mm | Width 1,25mm | Ancho 1,25mm
- Espessura 1mm | Thickness 1mm | Espesor 1mm
- Caixa com 5.000 peças | Box with 5,000 pieces | Caja con 5.000 piezas

Grampos para grampeadores pneumáticos

Bobby pins | Clips



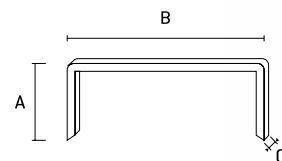

Código	Dimensões	Peso	DIMENSÕES SIZE TAMAÑO (MM)			Quant. Max.	Quant. Min.
			A	B	C		
576529	6 mm - 20GA - cx 5000 pçs	500g	6	1,25	1	30	0
576549	8 mm - 20GA - cx 5000 pçs	600g	8	1,25	1	30	0
576569	10 mm - 20GA - cx 5000 pçs	700g	10	1,25	1	30	0
576609	16 mm - 20GA - cx 5000 pçs	933g	16	1,25	1	15	0
576649	22 mm - 20GA - cx 5000 pçs	1300g	22	1,25	1	15	0



- Largura 11,2mm | Width 11,2mm | Ancho 11,2mm
- Espessura 0,6mm | Thickness 0,6mm | Espesor 0,6mm
- Caixa com 5.000 peças | Box with 5,000 pieces | Caja con 5.000 piezas

Pinador Pneumático para pinos 10-50mm

Pneumatic Pincher/10-50mm | Pintor Neumático/10-50mm



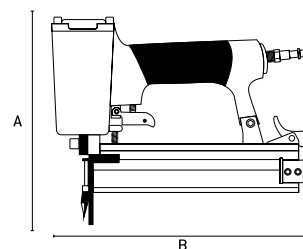

			DIMENSÕES SIZE TAMAÑO (MM)			
574109	10 - 50mm	1120g	A	B	10	0



• Pressão de trabalho: 7 BAR (100 PSI)

Grampeador Pneumático para grampos 10 - 22 mm

Pneumatic Stapler | Grapadora Neumática

			DIMENSÕES SIZE TAMAÑO (MM)			
574209	10 - 22mm	1483g	A	B	10	0

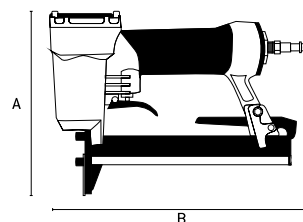

• Pressão de trabalho: 7 BAR (100 PSI)



AUTOMOTIVA

AUTOMOTIVE | AUTOMOTOR

FERRAMENTAS AUTOMOTIVAS

AUTOMOTIVE'S TOOLS
HERRAMIENTAS AUTOMOTORES

As ferramentas automotivas MTX e Sparta proporcionam a ergonomia apropriada ao trabalho a ser desenvolvido. Utilizando matérias primas de qualidade as ferramentas tem um ótimo desempenho e proporcionam um excelente resultado tanto para profissionais quanto para amadores.

MTX and Sparta automotive tools provide the right ergonomics for the work to be done. Utilizing quality raw materials the tools have a great performance and provide an excellent result for both professionals and amateurs.

Las herramientas automotrices MTX y Sparta proporcionan la ergonomía apropiada al trabajo a ser desarrollado. Utilizando materias primas de calidad las herramientas tienen un óptimo desempeño y proporcionan un excelente resultado tanto para profesionales como para aficionados.

SIMBOLOGIA



CÓDIGO
CODE



CARACTERÍSTICAS
Technical Features



PESO DA PEÇA
Part Weight
Peso de la Pieza



CAIXA MASTER
Box Master | Caja Máster



Quant. Min.

QUANT. MINÍMA
Quant. Minimum
Cantidad Mínima



Soquete para vela estriado 1/2"

Socket for candle | Enchufe para la vela



13188	ESTRIADO 16MM	109g	DIMENSÕES SIZE TAMAÑO (MM)		96	24
			A	B		
13189	ESTRIADO 21MM	162g	21	133	96	24

CrV
Alta
Qualidade

AUTO
SERVIÇO

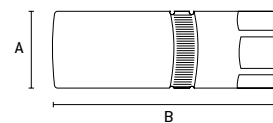

- Acabamento Polido | Polished Finish | Acabado Pulido
- Encaixe 1/2" | Fitting 1/2" | Encaje 1/2"
- Com imã | With magnet | Con el imán

Jogo de Soquetes 1/2"

Socket Set | Juego de Enchufe



13513	17 19 21	840g	DIMENSÕES SIZE TAMAÑO (MM)		20	0*
			Ø			
			17			
			19			
			21			

HEX

CrMo
STAHL



- Indicado para utilização em ferramentas pneumáticas | Suitable for use on pneumatic tools | Indicado para uso en herramientas neumáticas
- Resistente a impactos | Impact resistant | Resistente a impactos
- Encaixe 1/2" | 1/2" fitting | Enganche 1/2"

Soquetes Estriado

Striated Sockets | Enchufe Estriado



1363655	ESTRIADO 16 mm	94g	DIMENSÕES SIZE TAMAÑO (MM)		240	40
			A	B		
1363755	ESTRIADO 21 mm	141g	21	65	150	25

BIHEX

CrV
Alta
Qualidade



- Longo | Long | Largo
- Encaixe quadrado 1/2" | Square fitting 1/2" | Encaje cuadrado 1/2"

Jogo de Soquetes | Multifuncional

Socket Set Multifuncional | Juego de Enchufe multifuncional



antigo	novo		KG	DIMENSÕES SIZE TAMAÑO (MM)			Quant. Min.
				A	B		
13190	1319055	encaixe 1/2"	675g	11-32	153	20	10
13191	1319155	encaixe 3/8"	191g	6-21	123	96	12

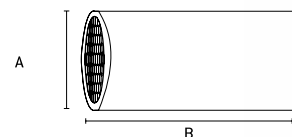

Ajustável a várias cabeças de parafusos
Adjustable to multiple screw heads
Ajustable a varias cabeças de tornillo

• Acabamento Polido | Polished Finish | Acabado Pulido

Soquetes Sextavados Temperados 1/2"

Tempered Hexagonal Sockets | Enchufes Sexto Templado



		KG	DIMENSÕES SIZE TAMAÑO (MM)			Quant. Min.
			A	B		
1380855	8 mm	55g	50	8	200	20
1380955	9 mm	55g	50	9	200	20
1381055	10 mm	55g	50	10	200	20
1381155	11 mm	55g	50	11	200	20
1381255	12 mm	55g	20	12	200	10
1381355	13 mm	63g	50	13	200	10
1381455	14 mm	63g	50	14	200	10
1381555	15 mm	65g	50	15	200	10
1381655	16 mm	65g	25	16	200	10
1381755	17 mm	75g	20	17	160	8
1381855	18 mm	75g	50	18	160	8
1381955	19 mm	81g	50	19	160	8
1382055	20 mm	88g	25	20	160	8
1382155	21 mm	94g	50	21	160	8
1382255	22 mm	106g	50	22	160	8
1382355	23 mm	117g	50	23	120	6
1382455	24 mm	121g	50	24	120	6
1382655	26 mm	165g	30	26	100	5
1382755	27 mm	175g	50	27	100	5
1382855	28 mm	200g	40	28	80	4
1383055	30 mm	213g	50	30	80	4
1383255	32 mm	200g	50	32	80	4
1384555	3/8"	55g	3/8"	100	200	10
1384655	7/16"	55g	7/16"	40	200	10
1384755	1/2"	55g	1/2"	100	200	10
1384855	9/16"	63g	9/16"	100	200	10
1384955	5/8"	65g	5/8"	100	200	10
1385055	11/16"	75g	11/16"	40	160	8
1385155	3/4"	75g	3/4"	100	160	8
1385255	13/16"	88g	13/16"	100	160	8
1385355	7/8"	106g	7/8"	100	160	8
1385455	15/16"	117g	15/16"	100	120	6
1385555	1"	165g	1"	40	100	5
1385655	1.1/8"	200g	1.1/8"	100	80	4
1385755	1.3/16"	213g	1.3/16"	40	80	4
1385855	1.1/4"	220g	1.1/4"	100	80	4

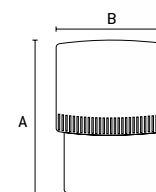

• Encaixe 1/2" | Fitting 1/2" | Encaje 1/2"
• Acabamento Niquelado e cromado fosco | Finish Nickel plated and chrome plated | Acabado Niquelado y cromado mate

Soquetes Estriado 1/2"

Striated Sockets 1/2" | Enchufes Estriado 1/2"



	KG	DIMENSÕES SIZE TAMAÑO (MM)		Quant. Min.		
		A	B			
1390855	8 mm	55g	35	8	200	10
1390955	9 mm	55g	35	9	200	10
1391055	10 mm	55g	35	10	200	10
1391155	11 mm	55g	35	11	200	10
1391255	12 mm	55g	35	12	200	10
1391355	13 mm	63g	40	13	200	20
1391455	14 mm	63g	40	14	200	20
1391555	15 mm	65g	40	15	200	20
1391655	16 mm	65g	40	16	200	20
1391755	17 mm	75g	40	17	160	8
1391855	18 mm	75g	40	18	160	8
1391955	19 mm	81g	40	19	160	8
1392055	20 mm	88g	40	20	160	8
1392155	21 mm	94g	40	21	160	8
1392255	22 mm	106g	40	22	160	8
1392355	23 mm	117g	40	23	120	6
1392455	24 mm	121g	40	24	120	5
1392655	26 mm	165g	40	26	100	5
1392755	27 mm	175g	40	27	100	5
1392855	28 mm	200g	45	28	80	4
1393055	30 mm	213g	45	30	80	4
1393255	32 mm	225g	45	32	80	4
<hr/>						
1394555	3/8"	55g	35	9,525	200	10
1394655	7/16"	55g	35	11,113	200	10
1394755	1/2"	55g	35	12,700	200	10
1394855	9/16"	63g	40	14,288	200	10
1394955	5/8"	65g	40	15,875	200	10
1395055	11/16"	75g	40	17,463	160	8
1395155	3/4"	75g	40	19,050	160	8
1395255	13/16"	88g	40	20,638	160	8
1395355	7/8"	106g	40	22,225	160	8
1395455	15/16"	117g	40	23,813	120	6
1395555	1"	165g	40	25,400	100	5
1395655	1.1/8"	200g	45	28,575	80	4
1395755	1.3/16"	213g	45	30,163	80	4
1395855	1.1/4"	225g	45	31,750	80	4

- Aço CrV Temperado | Stel CrV Temperate | Acero CrV templado
- Bi-Sextavado | Bi-hex | Bi-Hex
- Encaixe quadrado 1/2" | Square fitting 1/2" | Encaje cuadrado 1/2"
- Embalagem clip Plástico | Plastic Clip Packing | Embalaje de plástico

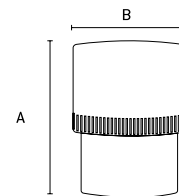

Linha de soquetes industriais

Industrial Socket Line | Línea de sockets industriales



	KG	DIMENSÕES SIZE TAMAÑO (MM)		Quant. Min.		
		A	B			
1322155	17 mm	275g	76	17	84	12
1322255	19 mm	276g	76	19	84	12
1322455	22 mm	308g	76	22	72	8

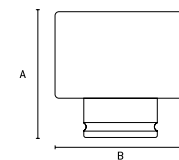

- Série Longa | Long Series | Serie Larga
- Aço CrMo de alta resistência Mecânica | CrMo Steel High Strength Mechanical | Acero CrMo de alta resistencia mecánica
- Tem alojamento para pino e anel de segurança | It has housing for pin and ring of security | Tiene alojamiento para pino y anillo de seguridad
- Para trabalhar com máquinas de impacto | To work with impact machines | Para trabajar con máquinas de impacto
- Encaixe quadrado 1/2" | Square fitting 1/2" | Encaje cuadrado 1/2"
- Embalagem: Caixa | Packing: Box | Embalaje: Caja

Linha de soquetes industriais

Industrial Socket Line | Línea de sockets industriales



	132	KG	DIMENSÕES SIZE TAMAÑO (MM)		Quant. Min.	
			A	B		
1320155	10 mm	75g	35	10	270	30
1320255	11 mm	76g	35	11	270	30
1320355	12 mm	76g	35	12	270	30
1320455	13 mm	77g	35	13	270	30
1320555	14 mm	82g	35	14	270	30
1320655	15 mm	119g	35	15	180	20
1320855	17 mm	125g	35	17	180	20
1320955	18 mm	124g	35	19	180	20
1321055	19 mm	124g	35	18	180	20
1321355	22 mm	135g	35	22	180	20

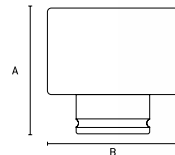

- Série Curta | Short Series | Serie Corta
- Aço CrMo de alta resistência Mecânica | CrMo Steel High Strength Mechanical | Acero CrMo de alta resistencia mecánica
- Tem alojamento para pino e anel de segurança | It has housing for pin and ring of security | Tiene alojamiento para pino y anillo de seguridad
- Para trabalhar com máquinas de impacto | To work with impact machines | Para trabajar con máquinas de impacto
- Encaixe quadrado 1/2" | Square fitting 1/2" | Encaje cuadrado 1/2"
- Embalagem: Caixa | Packing: Box | Embalaje: Caja

Linha de soquetes industriais

Industrial Socket Line | Línea de sockets industriales



	132	KG	DIMENSÕES SIZE TAMAÑO (MM)		Quant. Min.	
			A	B		
1325455	32 mm	460g	55	32	55	11
1325655	36 mm	495g	55	36	42	7
1325855	38 mm	510g	55	38	36	6
1325955	41 mm	620g	55	41	40	5

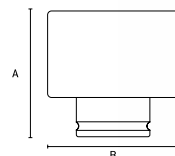

- Série Curta | Short Series | Serie Corta
- Aço CrMo de alta resistência Mecânica | CrMo Steel High Strength Mechanical | Acero CrMo de alta resistencia mecánica
- Tem alojamento para pino e anel de segurança | It has housing for pin and ring of security | Tiene alojamiento para pino y anillo de seguridad
- Para trabalhar com máquinas de impacto | To work with impact machines | Para trabajar con máquinas de impacto
- Encaixe quadrado 3/4" | Square fitting 3/4" | Encaje cuadrado 3/4"
- Embalagem: Caixa | Packing: Box | Embalaje: Caja

5

Jogo de Soquetes sextavados - 10 peças 1/2"

Socket Set Hexagonal - 10 parts | Juego de Sockets hexagonales - 10 piezas



10
peças
parts | piezas

Composição | Composition | composición:

- 10 soquetes: 10, 11, 12, 13, 14, 15, 17, 18, 19 e 22 mm.



1326155



1433g



15



0

CHAVE CORRESPONDENTE CORRESPONDING KEY CLAVE CORRESPONDENTE	KG	DIMENSÕES SIZE TAMAÑO (MM)	
		A	B
10 mm	75g	35	10
11 mm	76g	35	11
12 mm	76g	35	12
13 mm	77g	35	13
14 mm	82g	35	14
15 mm	119g	35	15
17 mm	125g	35	17
18 mm	124g	35	19
19 mm	124g	35	18
22 mm	135g	35	22

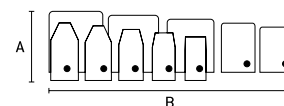

- Aço CrMo de alta resistência Mecânica | CrMo Steel High Strength Mechanical | Acero CrMo de alta resistencia mecánic
- Tem alojamento para pino e anel de segurança | It has housing for pin and ring of security | Tiene alojamiento para pino y anillo de seguridad
- Impacto | Sixth grade | Hexagonal
- Encaixe quadrado 1/2" | Square fitting 1/2" | Encaje cuadrado 1/2 "

Jogo de Soquetes sextavados - 11 peças 1/2"

Socket Set Hexagonal - 11 parts | Juego de Sockets hexagonales - 11 piezas



11
peças
parts | piezas

Composição | Composition | composición:

- 11 soquetes: 10, 11, 12, 13, 14, 15, 17, 18, 19, 22 e 24 mm.



1326255



3283g



6



0

CHAVE CORRESPONDENTE CORRESPONDING KEY CLAVE CORRESPONDENTE	KG	DIMENSÕES SIZE TAMAÑO (MM)	
		A	B
10 mm	150g	76	10
11 mm	152g	76	11
12 mm	152g	76	12
13 mm	154g	76	13
14 mm	164g	76	14
15 mm	238g	76	15
17 mm	250g	76	17
18 mm	248g	76	19
19 mm	248g	76	18
22 mm	270g	76	22
24 mm	308g	76	24

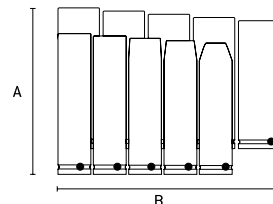

- Aço CrMo de alta resistência Mecânica | CrMo Steel High Strength Mechanical | Acero CrMo de alta resistencia mecánic
- Tem alojamento para pino e anel de segurança | It has housing for pin and ring of security | Tiene alojamiento para pino y anillo de seguridad
- Impacto | Sixth grade | Hexagonal
- Encaixe quadrado 1/2" | Square fitting 1/2" | Encaje cuadrado 1/2 "

Soquetes Sextavado 1/2"

Sixth Sockets 1/2" | Enchufes Sextavado 1/2"



Barcode	mm	g	DIMENSÕES SIZE TAMAÑO (MM)		Quant. Min.	
			A	B		
131109	10 mm	54g	35	10	400	40
131119	11 mm	56g	35	11	400	40
131129	12 mm	55g	35	12	400	40
131139	13 mm	58g	40	13	400	40
131149	14 mm	68g	40	14	400	40
131159	15 mm	58g	40	15	400	40
131169	16 mm	58g	40	16	400	40
131179	17 mm	67g	40	17	400	40
131189	18 mm	67g	40	18	300	10
131199	19 mm	70g	40	19	300	10
131209	20 mm	95g	40	20	200	10
131219	21 mm	90g	40	21	200	10
131229	22 mm	100g	40	22	200	10
131239	23 mm	110g	40	23	200	10
131249	24 mm	115g	40	24	200	20
131279	27 mm	160g	45	27	100	10
131309	30 mm	205g	45	30	120	12
131329	32 mm	230g	45	32	120	10

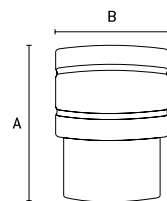

- Aço CrV Temperado | Stelil CrV Temperate | Acero CrV templado
- Acabamento Polido | Polished Finish | Acabado Pulido
- Encaixe quadrado 1/2" | Square fitting 1/2" | Encaje cuadrado 1/2"

Soquetes Estriado 1/2"

Striated Sockets 1/2" | Enchufes Estriado 1/2"



Barcode	mm	g	DIMENSÕES SIZE TAMAÑO (MM)		Quant. Min.	
			A	B		
136769	8 mm	53g	35	8	400	40
136789	9 mm	55g	35	9	400	40
136809	10 mm	55g	35	10	400	40
136829	11 mm	58g	40	11	400	40
136849	12 mm	58g	40	12	400	40
136869	13 mm	58g	40	13	400	10
136889	14 mm	58g	40	14	400	40
136899	15 mm	60g	40	15	400	40
136909	17 mm	65g	40	17	400	10
136919	19 mm	70g	40	19	300	30
136929	22 mm	95g	40	22	200	20
136939	24 mm	110g	40	24	200	20
136959	27 mm	150g	45	30	120	12
136979	30 mm	200g	45	30	120	12
136989	32 mm	218g	45	32	120	12

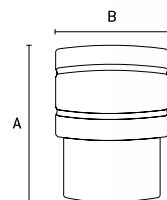

- Aço CrV Temperado | Stelil CrV Temperate | Acero CrV templado
- Bi-Sextavado | Bi-hex | Bi-Hex
- Acabamento Polido | Polished Finish | Acabado Pulido
- Encaixe quadrado 1/2" | Square fitting 1/2" | Encaje cuadrado 1/2"

5

Jogo de Soquetes 3/4"

Socket Set | Juego de Sockets



135369	soquetes 19 - 50	12.750g	DIMENSÕES SIZE TAMAÑO (MM)			2	Quant. Min.
			A	B	C		



Ajustável a várias cabeças de parafusos
Adjustable to multiple screw heads
Ajustable a varias cabezas de tornillo

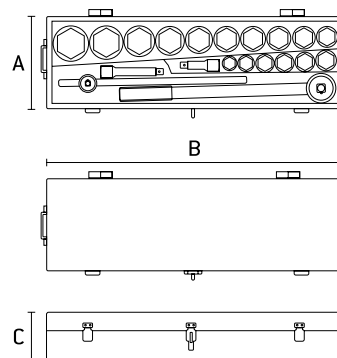

Composição | Composition | composición:

- 1 catraca de 3/4"
- 1 cabo de força T de 3/4"
- 1 extensão de 4" (100 mm)
- 1 extensão de 8" (200 mm)
- 16 soquetes: 19, 21, 22, 23, 24, 26, 27, 30, 32, 34, 36, 38, 41, 46, 48 e 50 mm.

- Aço CrV | Stel CrV | Acero CrV
- Caixa metálica | Metal case | Caja metálica
- Soquete Sextavado | Socket Sixth | Enchufe Hexagonal
- Encaixe 3/4" | Fitting 3/4 " | Encaje 3/4 "

Jogo de Soquetes - 26pçs - 3/4"

Socket Set - 26pcs - 3/4" | Juego de Sockets - 26pzs - 3/4"



135399	soquetes 21 - 62	19.500g	DIMENSÕES SIZE TAMAÑO (MM)			1	Quant. Min.
			A	B	C		

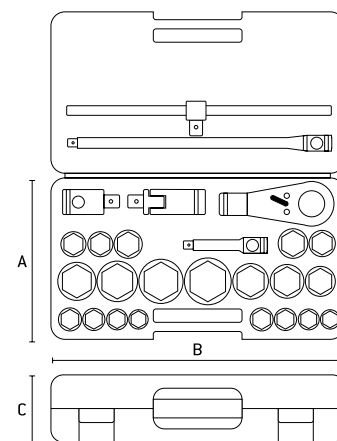

Composição | Composition | composición:

- 1 catraca de 3/4"
- 1 adaptador de 3/4" - 1"
- 1 cabo de força T de 3/4" (525 mm)
- 1 extensão reta de (525 mm)
- 1 extensão L de 8" (200 mm)
- 1 extensão de 8" (200 mm)
- 20 soquetes: 21, 22, 23, 24, 26, 27, 28, 29, 30, 31, 32, 34, 36, 38, 41, 46, 50, 55, 60 e 65 mm.

- Aço CrV | Stel CrV | Acero CrV
- Caixa plástica | Plastic box | Caja de plástico
- Soquete Sextavado | Socket Sixth | Enchufe Hexagonal
- Encaixe 3/4" | Fitting 3/4 " | Encaje 3/4 "

Jogo de Ferramentas/24pçs 1/2"

Tool Set - 24pcs | Juego de Herramientas-24pzs



135769



3500g

DIMENSÕES | SIZE | TAMAÑO (mm)

A B C

250 320 80



6



1



24 peças
total / piezas



Catraca com 72 dentes
Ratchet with 72 teeth
Catraca con 72 dientes



CONTEÚDO DA EMBALAGEM

- 1 Chave catraca reversível 1/2" com cabo emborrachado / 72 dentes
- 1 Barra extensora de 10"
- 1 Barra extensora de 5"
- 1 Chave de vela (soquete sextavado longo) de 21mm
- 1 Chave de vela (soquete sextavado longo) de 16mm
- 1 Cabo T ajustável 1/2"
- 18 Soquetes estriados 1/2": [8, 9, 10, 11, 12, 13, 14, 15, 16, 17, 18, 19, 21, 22, 24, 27, 30 e 32mm]

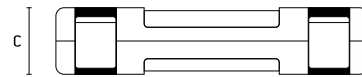
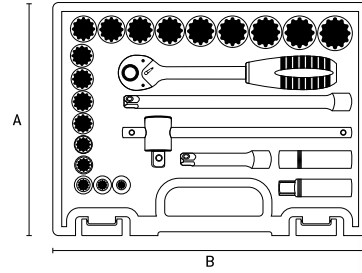

- Aço CrV de alta qualidade | High quality CrV steel | Acero CrV de alta calidad
- Bi-Sextavado | Bi-hex | Bi-Hex
- Caixa plástica | Plastic box | Caja de plástico
- Acabamento Fosco | Matte Finish | Acabado Mate
- Encaixe quadrado 1/2" | Square fitting 1/2" | Encaje cuadrado 1/2"

Jogo de Ferramentas/18pçs 1/2"

Tool Set-18pcs | Juego de Herramientas-18pzs



135779



4000g

DIMENSÕES | SIZE | TAMAÑO (mm)

A B C

250 320 80



6



1



18 peças
total / piezas



Catraca com 72 dentes
Ratchet with 72 teeth
Catraca con 72 dientes



CONTEÚDO DA EMBALAGEM

- 1 Chave catraca reversível 1/2" com cabo emborrachado / 72 dentes
- 1 Barra extensora de 10"
- 1 Barra extensora de 5"
- 1 Cabo T ajustável 1/2"
- 14 Soquetes estriados 1/2": [10, 11, 12, 13, 14, 15, 16, 17, 19, 21, 24, 27, 30 e 32mm]

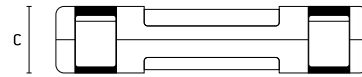
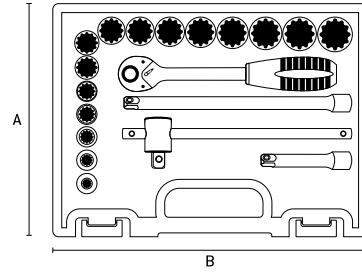

- Aço CrV de alta qualidade | High quality CrV steel | Acero CrV de alta calidad
- Bi-Sextavado | Bi-hex | Bi-Hex
- Caixa plástica | Plastic box | Caja de plástico
- Acabamento Fosco | Matte Finish | Acabado Mate
- Encaixe quadrado 1/2" | Square fitting 1/2" | Encaje cuadrado 1/2"

Jogo de Ferramentas/39pçs 1/2"

Tool Set-39pcs | Juego de Herramientas-39pzs



135789



5520g

DIMENSÕES | SIZE | TAMAÑO (mm)

A B C

290 380 100



4



1



39 peças
total / piezas



Catraca com 72 dentes
Ratchet with 72 teeth
Catraca con 72 dientes



CONTEÚDO DA EMBALAGEM

- 1 Chave catraca reversível 1/2" com cabo emborrachado / 72 dentes
- 1 Barra extensora de 10"
- 1 Barra extensora de 3"
- 1 Barra extensora de 5"
- 1 Junta Universal de 1/2"
- 18 Soquetes estriados 1/2" em mm: [10, 11, 12, 13, 14, 15, 16, 17, 18, 19, 20, 21, 22, 23, 24, 27, 30 e 32mm]
- 14 Soquetes estriados 1/2 em polegadas: [1/2, 3/8, 7/16, 9/16, 5/8, 11/16, 3/4, 13/16, 7/8, 15/16, 1, 1-1/16, 1-1/8, 1-3/16 polegadas]
- 2 Soquetes longos sextavados: 5/8 e 13/16"

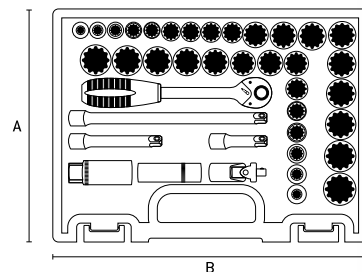

- Aço CrV de alta qualidade | High quality CrV steel | Acero CrV de alta calidad
- Bi-Sextavado | Bi-hex | Bi-Hex
- Caixa plástica | Plastic box | Caja de plástico
- Acabamento Fosco | Matte Finish | Acabado Mate
- Encaixe quadrado 1/2" | Square fitting 1/2" | Encaje cuadrado 1/2"

5

Jogo de Ferramentas/41 pçs

TOOL SET 41PCS | JUEGO DE HERRAMIENTAS 41PZS

135799 Maleta: 250x320x80mm 4700g 6 1



DETALHES DO PRODUTO

Material:
Aço cromo vanádio com acabamento cromado
Catraca com design ergonômico e 72 dentes
Encaixe de 1/2"
Acompanha maleta plástica

CONTEÚDO DA EMBALAGEM

- 1 Catraca reversível
- 1 Extensão 125mm
- 1 Junta universal
- 4 Soquetes estriados longos: **(14, 15, 17 e 19 mm)**
- 13 Soquetes estriados: **(10, 11, 12, 13, 14, 15, 17, 19, 22, 24, 27, 30 e 32 mm)**
- 1 Adaptador 1/2" F x 3/8"
- 1 Adaptador para bit 1/2" x 5/16"
- 8 Bits:
 - 2 Pozidriv: PZ3 e PZ4
 - 2 Phillips: PH3 e PH4
 - 2 Fenda: 8 e 10 mm
 - 2 Allen: 8 e 10 mm
- 1 Jogo de chaves allens com 9 peças e suporte: **(1.5, 2, 2.5, 3, 4, 5, 6, 8 e 10 mm)**



STELS

Jogo de Ferramentas/94 pçs

TOOL SET 94PCS | JUEGO DE HERRAMIENTAS 94PZS

1358099 6667g Maleta: 380x280x85mm 3 1



DETALHES DO PRODUTO

- Encaixe: 1/2" e 1/4"
- **Material:** Aço Cromo Vanádio
- Produtos de excelente qualidade, soquetes e chaves em Aço CR-V
- Soquetes 1/2" com boca estriada
- Catraca reversível com cabo emborrachado / 72 dente
- Maleta resistente

CONTEÚDO DA EMBALAGEM

- 1 Chave catraca reversível 1/2" com cabo emborrachado
- 1 Chave catraca reversível 1/4" com cabo emborrachado
- 1 Barra extensora 1/2 de 5"
- 1 Barra extensora 1/4 de 50mm
- 1 Barra extensora 1/4 de 100mm
- 1 Barra extensora flexível 1/4 de 150mm
- 1 Junta Universal de 1/2"
- 1 Junta Universal de 1/4"
- 1 Chave T de 1/2"
- 1 Chave T de 1/4"
- 1 Chave reta de 1/4"
- 18 Soquetes estriados:
 - (1/2" 10, 11, 12, 13, 14, 15, 16, 17, 18, 19, 20, 21, 22, 23, 24, 27, 30 e 32mm)
- 13 Soquetes estriados de 1/4":
 - (4, 4.5, 5, 5.5, 6, 7, 8, 9, 10, 11, 12, 14 e 14mm)
- 4 Soquetes longos multi-estriados 1/2: (14, 15, 17 e 19mm)
- 8 Soquetes longos multi-estriados 1/4:
 - (6, 7, 8, 9, 10, 11, 12 e 13mm)
- 33 pontas diversas, fenda, phillips, torx e allen
- 1 adaptador para bits de 1/2"
- 2 Chaves de vela (soquetes sextavados) de 16 e 21mm
- 3 Chaves Allen: 1.5, 2, 2.5mm



Jogo de Ferramentas/29 pçs 1/4"

TOOL SET 29PCS | JUEGO DE HERRAMIENTAS 29PZS

1410055	Maleta: 160x270x80mm	20



DETALHES DO PRODUTO

- Encaixe 1/4
- Produtos de excelente qualidade, soquetes e chaves em Aço CR-V
- Soquetes 1/4 com boca sextavada
- Catraca reversível 1/4 com cabo emborrachado / 72 dente
- Maleta resistente

CONTEÚDO DA EMBALAGEM

- 1 Chave catraca reversível 1/4 com cabo emborrachado
- 1 Barra extensora 2 polegadas
- 1 Junta universal de 1/4
- 1 Cabo T ajustável 1/4
- 1 Chave manual encaixe quadrado de 1/4
- 12 Soquetes sextavados encaixe 1/4 medidas: [4, 4.5, 5, 5.5, 6, 7, 8, 9, 10, 11, 12, 13mm]
- 12 Soquetes bits, sendo:
 - 2 bits phillips: PH1, PH2
 - 2 bits pozidriv: PZ1, PZ2
 - 3 bits fenda: SL4, SL5.5, SL7
 - 5 bits tipo allen: H3, H4, H5, H6, H8



STELS

1410155	Maleta - 160X270mm	15

Jogo de Ferramentas/57 pçs 1/4"

TOOL SET 57PCS | JUEGO DE HERRAMIENTAS 57PZS



DETALHES DO PRODUTO

- Encaixe 1/4
- Produtos de excelente qualidade, soquetes e chaves em Aço CRV
- Soquetes 1/4 com boca sextavada
 - Catraca reversível 1/4 com cabo emborrachado / 72 dente
- Maleta resistente

CONTEÚDO DA EMBALAGEM

- 1 Chave catraca reversível 1/4 com cabo emborrachado
- 1 Barra extensora 2 polegadas
- 1 Barra extensora 4 polegadas
- 1 Junta universal de 1/4
- 1 Chave manual encaixe quadrado de 1/4
- 4 Chaves hexagonais tipo allen, medidas: [1.5, 2, 2.5, 3mm]
- 4 Soquetes sextavados longos, medidas: [6, 7, 8, 10]
- 13 Soquetes sextavados encaixe 1/4, medidas: [4, 4.5, 5, 5.5, 6, 7, 8, 9, 10, 11, 12, 13, 14mm]
- 06 Soquetes torx fêmea, medidas: [E4, E5, E6, E7, E8, E10]
- 24 Soquetes bits, sendo:
 - 3 bits phillips: PH1, PH2, PH3
 - 3 bits pozidriv: PZ1, PZ2, Pz3
 - 3 bits fenda: SL4, SL5.5, SL6.5
 - 7 bits tipo allen: H3, H4, H5, H6, H8
- 8 bits torx (sem furo guia): T8, T10, T15, T20, T25, T27, T30, T40



Jogo de Soquetes/curto

Socket Set /short | Juego de Sockets /corto



Código	Descrição	DIMENSÕES SIZE TAMAÑO (MM)		Quant. Min.	
		A	B		
135579	ENCAIXE 1/2" 10 - 22mm	100	390	30	10
135589	ENCAIXE 3/8" 8 - 19mm	965	330	50	10
135599	ENCAIXE 1/4" 4 - 13mm	70	245	60	10

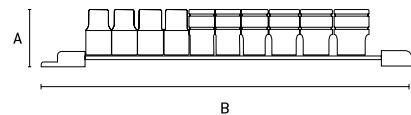

- Aço CrV | CrV steel | Acero CrV
- Sextavado | Sixth grade | Hexagonal
- Acabamento Polido | Polished Finish | Acabado Pulido

- Composição | Composition | composición:
- 135579: 10 soquetes 1/2": 10, 11, 12, 13, 14, 15, 17, 18, 19, 22 mm.
 - 135589: 10 soquetes 3/8: 8,,10, 11, 12, 13, 14, 15, 17, 18, 19 mm.
 - 135599: 10 soquetes 1/4: 4, 5, 6, 7, 8, 9, 10, 11, 12, 13 mm.

Jogo de Soquetes/curto

Socket Set /short | Juego de Sockets /corto



Código	Descrição	DIMENSÕES SIZE TAMAÑO (MM)		Quant. Min.	
		A	B		
135949	ENCAIXE 1/4" 4 - 13mm	70	245	60	6
135969	ENCAIXE 1/2" 10 - 24mm	100	390	30	10



- Aço CrV | CrV steel | Acero CrV
- Estriado | Striated | Estriado
- Acabamento Polido | Polished Finish | Acabado Pulido

- Composição | Composition | composición:
- 135949: 10 soquetes 1/4: 4, 5, 6, 7, 8, 9, 10, 11, 12, 13 mm.
 - 135969: 10 soquetes 1/2": 10, 11, 12, 13, 14, 16, 17, 19, 22 e 24 mm.

Jogo de Soquetes/longo

Sockets / Long Set | Juego de Sockets / Largo



Código	Descrição	DIMENSÕES SIZE TAMAÑO (MM)		Quant. Min.	
		A	B		
135909	ENCAIXE 1/2" 10 - 22mm	120	355	20	0
135919	ENCAIXE 3/8" 8 - 19mm	120	355	30	5

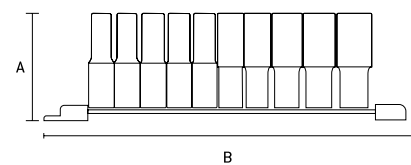

- Aço CrV | CrV steel | Acero CrV
- Sextavado | Sixth grade | Hexagonal
- Longo | Long | Largo
- Acabamento Polido | Polished Finish | Acabado Pulido

- Composição | Composition | composición:
- 135909: 10 soquetes 1/2": 10, 11, 12, 13, 14, 15, 17, 18, 19, 22 mm
 - 135919: 10 soquetes 3/8: 8,,10, 11, 12, 13, 14, 15, 17, 18, 19 mm.

Jogo de Soquetes SPLINE 1/2"

Socket Set SPLINE | Juego de Sockets SPLINE



Código	Descrição	DIMENSÕES SIZE TAMAÑO (MM)		Quant. Min.	
		A	B		
135979	ENCAIXE 1/2" 10 - 22	100	10 - 22mm	30	0

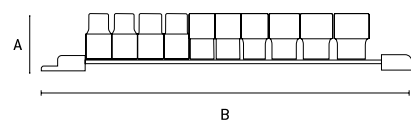

- Aço CrV | CrV steel | Acero CrV
- Spline | Spline | Spline
- Curtos | Short | Corto
- Acabamento Polido | Polished Finish | Acabado Pulido

- Composição | Composition | composición:
- 135979: 10 soquetes 1/2": 10, 11, 12, 13, 14, 15, 17, 18, 19, 22 mm

Jogo de Soquetes/curto

Socket Set /short | Juego de Sockets /corto



- Aço CrV | CrV steel | Acero CrV
- Sextavado | Sixth grade | Hexagonal
- Curtos | Short | Corto
- Acabamento Polido | Polished Finish | Acabado Pulido

Código	Descrição	DIMENSÕES SIZE TAMAÑO (MM)		Quant. Máx.	Quant. Min.
		A	B		
1355755	Encaixe 1/2" 10 - 22mm	100	390	20	10
1355855	Encaixe 3/8" 8 - 19mm	965	330	20	10
1355955	Encaixe 1/4" 4 - 13mm	70	245	50	10

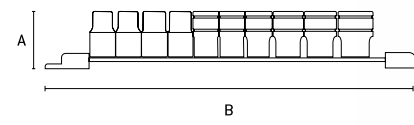

- Composição | Composition | composición:
- 1355755: 10 soquetes 1/2": 10, 11, 12, 13, 14, 15, 17, 18, 19, 22 mm.
 - 1355855: 10 soquetes 3/8": 8, 10, 11, 12, 13, 14, 15, 17, 18, 19 mm.
 - 1355955: 10 soquetes 1/4": 4, 5, 6, 7, 8, 9, 10, 11, 12, 13 mm.

Jogo de Soquetes/curto

Socket Set /short | Juego de Sockets /corto



- Aço CrV | CrV steel | Acero CrV
- Estriado | Striated | Estriado
- Curtos | Short | Corto
- Acabamento Polido | Polished Finish | Acabado Pulido

Código	Descrição	DIMENSÕES SIZE TAMAÑO (MM)		Quant. Máx.	Quant. Min.
		A	B		
1359455	Encaixe 1/4" 4 - 13mm	70	245	50	10
1359655	Encaixe 1/2" 10 - 24mm	100	390	20	10

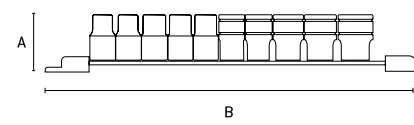

- Composição | Composition | composición:
- 1359455: 10 soquetes 1/4": 4, 5, 6, 7, 8, 9, 10, 11, 12, 13 mm.
 - 1359655: 10 soquetes 1/2": 10, 11, 12, 13, 14, 16, 17, 19, 22 e 24 mm.

Jogo de Soquetes/longo

Socket Set / Long Set | Juego de Sockets / Largo



- Aço CrV | CrV steel | Acero CrV
- Sextavado | Sixth grade | Hexagonal
- Longo | Long | Largo
- Acabamento Polido | Polished Finish | Acabado Pulido

Código	Descrição	DIMENSÕES SIZE TAMAÑO (MM)		Quant. Máx.	Quant. Min.
		A	B		
1359055	Encaixe 1/2" 10 - 22mm	120	355	10	10
1359155	Encaixe 3/8" 8 - 19mm	120	355	20	10

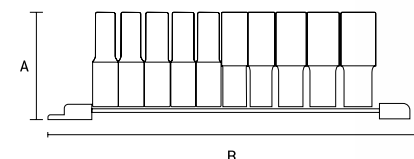

- Composição | Composition | composición:
- 1359055: 10 soquetes 1/2": 10, 11, 12, 13, 14, 15, 17, 18, 19, 22 mm
 - 1359155: 10 soquetes 3/8": 8, 10, 11, 12, 13, 14, 15, 17, 18, 19 mm.



Extensão Flexível

Flexible Extension | Extensión Flexible

CrV
Alta
Qualidade

MINEDIN



STELS	STELS	KG	DIMENSÕES SIZE TAMAÑO (MM)			Quant. Min.
			A	B		
11369	1136756	76g	13	260	50	0
11369	1136956	96g	13	278	50	0

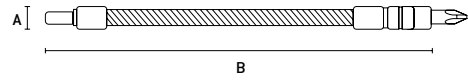

Encaixe 1/4"
Fitting 1/4"
Encaje 1/4"



Extensões

Extensions | Extensiones

STELS

CrV
Alta
Qualidade



novo	KG	DIMENSÕES SIZE TAMAÑO (MM)			Quant. Min.		
		A	B	C			
1390255	1/4"	24g	6	50	12	900	60
1390355	1/4"	67g	6	150	12	300	20
1390455	3/8"	84g	10	75	18	240	60
1390555	3/8"	150g	10	150	18	150	25
1390655	1/2"	202g	13	125	23	120	30
1390856	1/2"	405g	13	250	22	60	10



- Aço CrV de alta qualidade | High quality CrV steel | Acero CrV de alta calidad
- Acabamento Fosco | Matte Finish | Acabado Mate

Extensões

Extensions | Extensiones

mtx®

CrV
Alta
Qualidade



KG	DIMENSÕES SIZE TAMAÑO (MM)	Quant. Min.				
			A	B		
139729	125mm encaixe 1/2"	205g	13	125	120	12
139739	250mm encaixe 1/2"	400g	13	250	60	5

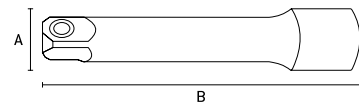

- Aço CrV | CrV steel | Acero CrV
- Acabamento Polido | Polished Finish | Acabado Pulido

Extensões abaulada

Extensions bulging | Extensiones abombadas



Código	Tamanho	Peso	DIMENSÕES SIZE TAMAÑO (MM)		Quant. Min.
			A	B	
139709	1/4"	48g	6	100	10
139719	3/8"	78g	10	75	10
139799	1/2"	230g	13	125	20

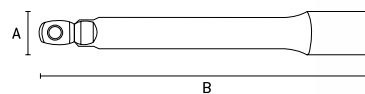

- Aço CrV | CrV steel | Acero CrV
- Acabamento Polido | Polished Finish | Acabado Pulido



- Ponta abaulada | Bullet point | Extremidad abombada
- Articula em ângulo de 25° | Articulates at an angle of 25° | Articula en ángulo de 25°

Extensão Flexível | 1/4"

Flexible Extension-1/4" | Extensión Flexible-1/4"



Código	Tamanho	Peso	DIMENSÕES SIZE TAMAÑO (MM)		Quant. Min.
			A	B	
1390956	150mm 1/4"	62g	12	150	20

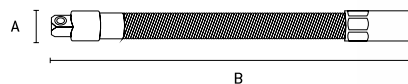

- Aço CrV | Stel CrV | Acero CrV
- Para soquetes manuais com encaixe quadrado 1/4" | For manual sockets with square fitting 1/4" | Para sockets manuales con ranura cuadrada 1/4"
- Acabamento Polido | Polished Finish | Acabado Pulido
- Flexível | Flexible | Flexible

Cabo de Força Articulado 1/2" quadrado

Articulated Power Cable 1/2" square | Cable de Fuerza Articulado 1/2" cuadradas



Código	Tamanho	Peso	DIMENSÕES SIZE TAMAÑO (MM)		Quant. Min.
			A	B	
140669	380mm, encaixe 1/2"	750g	13	380	7

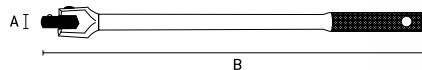

- A articulação em ângulo de (180 graus) | The angled articulation of (180 degrees) | La articulación en ángulo de (180 grados)

- Aço CrV | CrV steel | Acero CrV
- Acabamento Polido | Polished Finish | Acabado Pulido

5

Junta universal

Universal joint | Junta universal



139939	1/4"	33g	DIMENSÕES SIZE TAMAÑO (MM)		800	10
			A	B		
139949	3/8"	67g	20	54	360	60
139959	1/2"	155g	23	72	150	25

CrV
Alta
Qualidade

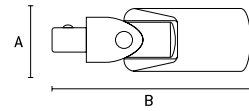

- Aço CrV | CrV steel | Acero CrV
- Acabamento Polido | Polished Finish | Acabado Pulido

Adaptador

Adapter | Adaptador



1390155	1/4" - 3/8"	21g	DIMENSÕES SIZE TAMAÑO (MM)		1000	50
			A	B		
1391156	3/8" - 1/2"	55g	450	30		

CrV
Alta
Qualidade

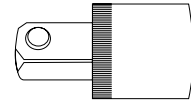

Chave suporte para soquetes

Socket wrench holder | Llave de soporte para sockets

1401255	1/4" (150)	94g	DIMENSÕES SIZE TAMAÑO (MM)		240	30
			A	B		
			6,350	150		

CrV
Alta
Qualidade

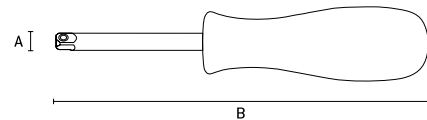

- Haste em Aço CrV | CrV Steel Rod | Vástago en Acero CrV
- Cabo ergonômico | Ergonomic cable | Mango ergonómico
- Encaixe quadrado | Fitting square | Encaje cuadrado
- Para soquetes | For sockets | Para los sockets

Chave suporte para soquetes

Socket wrench holder | Llave de soporte para sockets

139209	1/4" (150)	95g	DIMENSÕES SIZE TAMAÑO (MM)		200	10
			A	B		
			6,350	150		

CrV
Alta
Qualidade

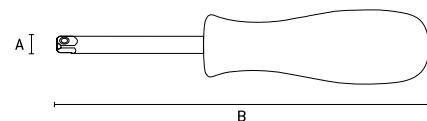

- Encaixe quadrado | Fitting square | Encaje cuadrado

Cabo de força "T"

Power cable "T" | Cable de fuerza "T"



Código	Dimensões	Peso (KG)	DIMENSÕES SIZE TAMAÑO (MM)			Quant. Min.
			A	B	C	
139869	115mm, encaixe 1/4"	48g	25	115	400	10
139879	200mm, encaixe 3/8"	181g	32	200	120	10
139889	250mm, encaixe 1/2"	371g	42	250	48	8

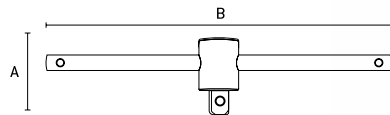

- Aço CrV | CrV steel | Acero CrV
- Acabamento Fosco | Matte Finish | Acabado Mate

Cabo de força "T"

Power cable "T" | Cable de fuerza "T"



Código	Dimensões	Peso (KG)	DIMENSÕES SIZE TAMAÑO (MM)			Quant. Min.
			A	B	C	
1401155	115mm, encaixe 1/4"	47g	14	115	400	30

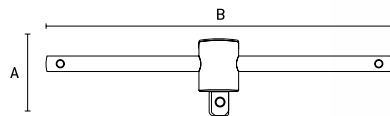

- Aço CrV de alta qualidade | High quality CrV steel | Acero CrV de alta calidad
- Acabamento Fosco | Matte Finish | Acabado Mate

Chave de catraca

Ratchet wrench | Llave de trinquete



Código	Encaixe	Peso (KG)	DIMENSÕES SIZE TAMAÑO (MM)			Quant. Min.	
			A	B	C		
1402055	Encaixe 1/4"	136g	6,350	125	30	100	20
1404055	Encaixe 3/8"	223g	9,525	185	32	50	10
1406055	Encaixe 1/2"	270g	12,700	230	35	50	10

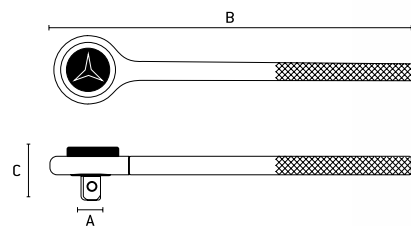

- Sistema reversível com pino | Reversible system with pin | Sistema reversible con pin
- Acabamento Cromado | Chrome Finish | Acabado Cromado

Chave de catraca

Ratchet wrench | Llave de trinquete



Código	Encaixe	Peso (KG)	DIMENSÕES SIZE TAMAÑO (MM)			Quant. Min.	
			A	B	C		
1401055	Encaixe 1/4"	170g	6,350	150	30	100	0
1401355	Encaixe 3/8"	250g	9,525	200	35	50	0
140159	Encaixe 1/2"	300g	12,700	250	40	25	0

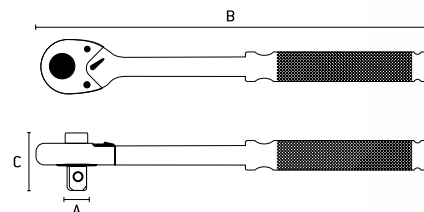

- Aço CrV | CrV steel | Acero CrV
- Sistema reversível com pino | Reversible system with pin | Sistema reversible con pin
- Acabamento Cromado | Chrome Finish | Acabado Cromado

5

Chave de catraca

Ratchet wrench | Llave de trinquete



antigo	novo	53	KG	DIMENSÕES SIZE TAMAÑO (MM)			Quant. Min.	
				A	B	C		
14026	1402555	Encaixe 1/4"	150g	6,350	150	30	100	20
	1402655	Encaixe 3/8"	250g	9,525	200	35	50	10
	1402755	Encaixe 1/2"	300g	12,700	250	40	50	5

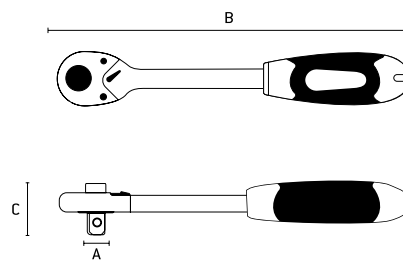

- Sistema reversível com pino rápido | Reversible system with fast pin | Sistema reversible con pin rápido
- Catraca com 72 Dentes | Ratchet with 72 Teeth | Catraca con 72 dientes
- Cabo de dois componentes | Two-component cable | Mango de dos componentes

Chave de catraca Teflonada

Teflon Ratchet wrench | Llave de trinquete Teflón



antigo	novo	53	KG	DIMENSÕES SIZE TAMAÑO (MM)			Quant. Min.	
				A	B	C		
14028	1402855	Encaixe 1/4"	150g	6,350	150	30	100	10
14029	1402955	Encaixe 3/8"	250g	9,525	200	35	50	10
14030	1403055	Encaixe 1/2"	300g	12,700	250	40	50	5

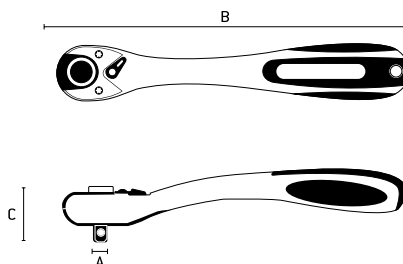

- Sistema reversível com pino rápido | Reversible system with fast pin | Sistema reversible con pin rápido
- Catraca com 72 Dentes | Ratchet with 72 Teeth | Catraca con 72 dientes
- Teflonada | Teflon | Teflón

Chave de catraca Teflonada

Teflon Ratchet wrench | Llave de trinquete Teflón



Sistema reversível com pino rápido
Reversible system with fast pin
Sistema reversible con pin rápido

antigo	novo	53	KG	DIMENSÕES SIZE TAMAÑO (MM)			Quant. Min.	
				A	B	C		
14082		Encaixe 1/2"	300g	12,700	250	40	24	6*
14084		Encaixe 3/8"	250g	9,525	200	35	48	12*
14086		Encaixe 1/4"	150g	6,350	150	30	100	25*

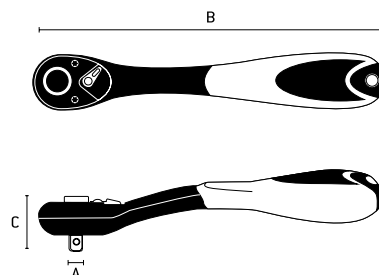

- Catraca com 72 Dentes | Ratchet with 72 Teeth | Catraca con 72 dientes
- Teflonada | Teflon | Teflón

Jogo de Chave de catraca 11 peças

11 Piece Ratchet Wrench Set | Juego de llave de trinquete 11 piezas



11 peças
parts | piezas

1412755	1/2" Soquetes (10-22mm)	1253g	DIMENSÕES SIZE TAMAÑO (MM)		15	5
			A	B		
			100	320		

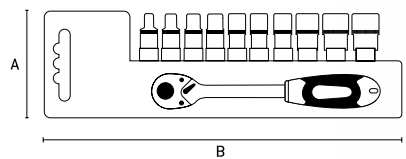

Composição:
 - 1 Chave de catraca de 1/2"
 - 10 soquete sextavado: 10 | 12 | 13 | 14 | 15 | 16 | 17 | 19 | 21 | 22mm

- Catraca com 72 Dentes | Ratchet with 72 Teeth | Catraca con 72 dientes
- Soquetes (10 - 22mm) | Sockets (10 - 22mm) | Enchufe (10 - 22mm)

Torquímetro

TorqueMeter | Llave dinamométrica



141609	42 - 210 n.m (21 kg)	75	485	15	1
141629	70 - 350 n.m (35 kg)	80	658	8	1

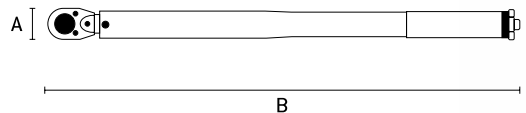

- Encaixe de 1/2" | 1/2 "fitting | Encaje de 1/2 "
- Divisão de escala: 0,35 Nm | Range Division: 35 Nm | División de escala: 0,35 Nm
- Ajuste de torque com trava (cabo) | Torque adjustment with lock (cable) | Ajuste de torsión con trava (cable)
- O torquímetro permite limitar com precisão a força aplicada para apertar parafusos |

The torque wrench allows you to precisely limit the force applied to tightening screws | El torquímetro permite limitar con precisión la fuerza aplicada para apretar tornillos

- É fabricado em aço cromo Vanádio com catraca reversa | It is made of chrome Vanadium steel with reverse ratchet | Es fabricado en acero cromo Vanadio con catraca reversa

Chave de Roda Tipo L

Type L Wheel Wrench | Llave de Rueda Tipo L



1421055	17mm	575g	115	250	40	10
1422455	19mm	625g	115	250	40	10

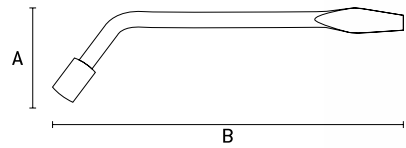

- Com espátula | With spatula | Con espátula

5

Chave de Roda em Cruz
Cross Wheel Wrench | Llave de Rueda en Cruz



			DIMENSÕES SIZE TAMAÑO (MM)		
1424555	Encaixe 1/2"	1892g	A 492	12	0

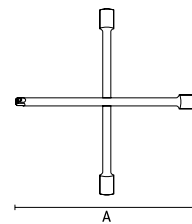

Chave de Roda
Wheel Wrench | Llave de Rueda



			DIMENSÕES SIZE TAMAÑO (MM)			
142379	Encaixe 1/2" ; 17x19 mm	1055g	A 137	B 427	20	0

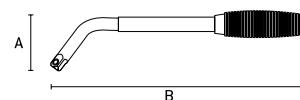

- Com Soquete 17x19mm | With Socket 17x19mm | Con Socket 17x19mm

Chave de Roda
Wheel Wrench | Llave de Rueda



			DIMENSÕES SIZE TAMAÑO (MM)			
14250	Encaixe 1/2" 17x18x21mm	1444g	A 467		16	8

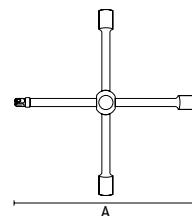

- Aço CrV Temperado | Tempered CrV Steel | Acero CrV Templado

Chave de Roda Montável

Mountable Wheel Wrench | Llave de Rueda de montaje



antigo	novo			DIMENSÕES SIZE TAMAÑO (MM)				Quant. Min.
			KG	A	B	C		
14270	1427055	17 X 19 X 21 X 23mm	1892g	81	492	65	12	0

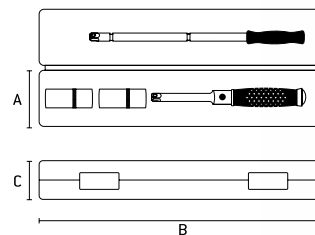

- Chave montável com soquetes | Mountable switch with sockets | Llave de montaje con sockets

Chave Fixa

Fixed key | Clave fija

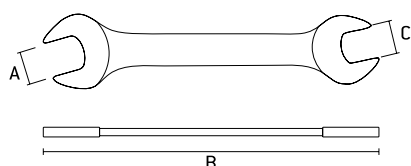

				DIMENSÕES SIZE TAMAÑO (MM)				Quant. Min.
			KG	A	B	C		
1440155	6 X 7 mm	30g	20	120	7	1000	50	
1440255	8 X 9 mm	40g	20	130	9	600	50	
1440355	10 X 11 mm	60g	70	280	11	400	50	
1440455	12 X 13 mm	80g	30	170	13	300	25	
1440555	14 X 15 mm	100g	30	180	15	250	25	
1440655	16 X 17 mm	140g	35	200	17	100	25	
1440755	18 X 19 mm	190g	40	220	19	100	10	
1440855	20 X 22 mm	230g	45	230	22	100	10	
1440955	21 X 23 mm	260g	50	240	23	100	10	
1441055	24 X 26 mm	350g	50	260	26	60	5	
1441155	25 X 28 mm	430g	60	270	28	50	5	

- Aço CrV Temperado | Tempered CrV Steel | Acero CrV Templado
- Acabamento Fosco | Matte Finish | Acabado Mate

Chave de Biela

Connecting rod wrench | Llave de Biela

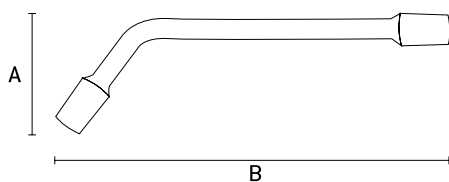

				DIMENSÕES SIZE TAMAÑO (MM)			Quant. Min.
		KG	A	B			
1420155	3/8"	250g	85	230	100	0	
1420255	7/16"	270g	85	230	100	0	
1420355	1/2"	320g	85	240	80	0	
1420455	9/16"	420g	95	240	80	0	
1420555	5/8"	420g	95	240	50	0	
1420655	11/16"	470g	100	260	50	0	
1420755	3/4"	530g	100	260	40	0	
1430155	8mm	220g	85	230	100	0	
1430255	9mm	230g	85	230	100	0	
1430355	10mm	250g	85	230	100	0	
1430455	11mm	270g	85	230	100	0	
1430555	12mm	270g	95	240	80	0	
1430655	13mm	320g	95	240	80	0	
1430755	14mm	320g	95	240	80	0	
1430855	15mm	420g	95	240	50	0	
1430955	16mm	420g	95	240	50	0	
1431055	17mm	440g	100	260	50	0	
1431155	18mm	470g	100	260	40	0	
1431255	19mm	530g	100	260	40	0	

- Aço CrV | Stell CrV | Acero CrV
- Tipo L | Type L | Tipo L
- Niquelado | Nickel plated | Níquel

Chave estrela c/ catraca

Fixed wrench with ratchet | Llave fija con tornillo



Código	Tamanho	Peso	DIMENSÕES SIZE TAMAÑO (MM)			Quant. Min.	
			A	B	C		
145039	12 X 13 mm	138g	12	235	13	200	10
145049	14 X 15 mm	190g	14	246	15	150	10
145059	16 X 17 mm	242g	16	250	17	120	5
145079	18 X 19 mm	336g	18	235	19	100	5

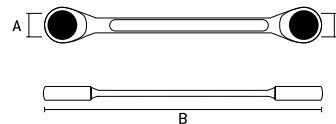

- Cabeça com catraca | Ratchet head | Cabeza con trinquete
- Acabamento Cromado | Chrome Finish | Acabado Cromado
- Norma DIN 3113 | Standard DIN 3113 | Norma DIN 3113

Chave Combinada

Combined key | Llave Combinada



Código	Tamanho	Peso	DIMENSÕES SIZE TAMAÑO (MM)		Quant. Min.	
			A	B		
1460155	6 mm	32g	6	160	1200	0
1460255	7 mm	39g	7	170	1200	0
1460355	8 mm	45g	8	170	800	0
1460455	9 mm	49g	9	180	600	0
1460555	10 mm	61g	10	190	600	0
1460655	11 mm	69g	11	200	400	0
1460755	12 mm	73g	12	200	400	0
1460855	13 mm	89g	13	220	300	0
1460955	14 mm	108g	14	220	300	0
1461055	15 mm	124g	15	220	200	0
1461155	16 mm	139g	16	240	200	0
1461255	17 mm	151g	17	240	200	0
1461355	18 mm	161g	18	240	160	0
1461455	19 mm	183g	19	260	160	0
1461555	20 mm	207g	20	260	120	0
1461655	21 mm	225g	21	280	120	0
1461755	22 mm	240g	22	280	80	0
1461855	23 mm	285g	23	280	80	0
1461955	24 mm	327g	24	305	80	0
1462055	25 mm	337g	25	305	80	0
1462155	26 mm	375g	26	305	60	0
1462255	27 mm	415g	27	320	60	0
1462355	28 mm	450g	28	320	50	0
1462455	29 mm	483g	29	320	50	0
1462555	30 mm	515g	30	360	40	0
1462655	32 mm	595g	32	360	40	0
1462755	36 mm	940g	36	360	20	0

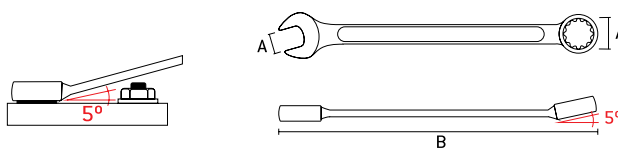

- Acabamento Fosco | Matte Finish | Acabado Mate

Chave Estrela

Star key | Clave estrella



Código	Tamanho	Peso	DIMENSÕES SIZE TAMAÑO (MM)			Quant. Min.	
			A	B	C		
1450155	6 X 7 mm	40g	6	170	7	400	50
1450255	8 X 9 mm	60g	8	190	9	300	20
1450355	10 X 11 mm	90g	10	200	11	200	20
1450455	12 X 13 mm	110g	12	220	13	200	20
1450555	14 X 15 mm	140g	14	240	15	150	10
1450655	16 X 17 mm	180g	16	270	17	100	10
1450755	18 X 19 mm	230g	18	300	19	100	10
1450855	20 X 22 mm	320g	20	330	22	60	5
1450955	21 X 23 mm	370g	21	320	23	60	5
1451055	24 X 26 mm	420g	24	350	26	60	5
1451155	26 X 28 mm	480g	26	360	28	50	5
1451255	27 X 32 mm	640g	27	370	32	40	5
1451355	30 X 32 mm	640g	30	370	32	40	5



- Aço CrV Temperado | Tempered CrV Steel | Acero CrV Templado
- Acabamento Fosco | Matte Finish | Acabado Mate

Chave Combinada

Combined key | Llave Combinada

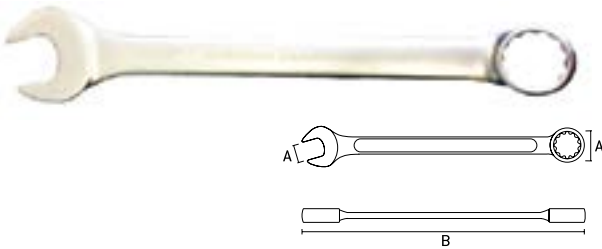

- Aço CrV Temperado de alta qualidade | High Quality Tempered CrV Steel | Acero CrV Templado de alta calidad
- Acabamento Fosco | Matte Finish | Acabado Mate

	DIMENSÕES SIZE TAMAÑO (MM)	Quant. Min.	DIMENSÕES SIZE TAMAÑO (MM)		Quant. Min.	
			A	B		
1463055	1/4"	20g	6,350	100	1200	100
1463155	5/16"	30g	7,938	120	600	100
1463255	3/8"	40g	9,525	135	600	50
1463355	7/16"	50g	11,113	150	400	50
1463455	1/2"	80g	12,700	170	300	50
1463555	9/16"	80g	14,288	180	300	30
1463655	5/8"	110g	15,875	200	200	20
1463755	11/16"	130g	17,463	200	200	20
1463855	3/4"	180g	19,050	230	150	10
1463955	13/16"	220g	20,638	250	100	10
1464055	7/8"	260g	22,225	250	100	10
1464155	15/16"	300g	23,813	280	80	10
1464255	1"	330g	25,400	290	80	5
1464355	1.1/16"	390g	26,988	310	60	5
1464455	1.1/8"	460g	28,575	330	50	5
1464555	1.3/16"	500g	30,163	340	40	5
1464655	1.1/4"	570g	31,750	360	40	5

Chave Combinada

Combined key | Llave Combinada

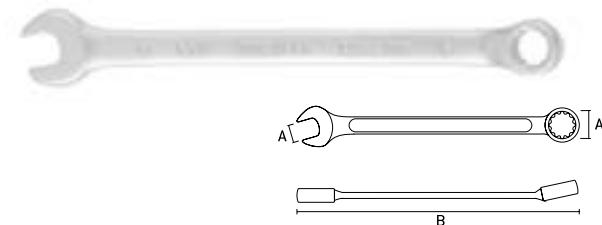

- Acabamento acetinado | Matte Finish | Acabado Mate
- Norma DIN 3113 | Standard DIN 3113 | Norma DIN 3113
- Alta resistência a torções, não quebra e não estilhaça com sobrecarga | High torsional, non-breaking and non-shattering with overload | Alta resistencia a la torsión, no se rompe y no se rompe con sobrecarga

	DIMENSÕES SIZE TAMAÑO (MM)	Quant. Min.	DIMENSÕES SIZE TAMAÑO (MM)		Quant. Min.	
			A	B		
151029	6 mm	27g	6	100	300	75
151039	7 mm	30g	7	111	300	75
151049	8 mm	42g	8	123	240	60
151059	9 mm	38g	9	130	240	60
151069	10 mm	55g	10	140	200	50
151079	11 mm	62g	11	150	200	50
151089	12 mm	72g	12	160	200	50
151099	13 mm	95g	13	170	200	50
151109	14 mm	102g	14	182	200	50
151119	15 mm	098g	15	190	200	50
151139	17 mm	130g	17	210	200	50
151159	19 mm	188g	19	230	100	25
151169	20 mm	218g	20	240	100	25
151189	22 mm	270g	22	260	80	20
151199	24 mm	333g	24	280	60	15
151209	27 mm	410g	27	310	50	5
151219	32 mm	648g	32	360	50	5

Chave Combinada com catraca

Combined key | Llave Combinada



- Cabeça com catraca | Ratchet head | Cabeza con trinquete
- Acabamento Cromado | Chrome Finish | Acabado Cromado
- Norma DIN 3113 | Standard DIN 3113 | Norma DIN 3113
- Permite execução de trabalhos com facilidade e menor esforço usuário | Allows execution of jobs with ease and less user effort | Permite la ejecución de trabajos con facilidad y menor esfuerzo de usuario

	DIMENSÕES SIZE TAMAÑO (MM)	Quant. Min.	DIMENSÕES SIZE TAMAÑO (MM)		Quant. Min.	
			A	B		
148019	8 mm	70g	8	200	240	20
148029	9 mm	95g	9	150	240	10
148039	10 mm	90g	10	160	240	10
148049	11 mm	44g	11	165	240	10
148059	12 mm	119g	12	175	200	10
148069	13 mm	135g	13	180	200	10
148079	14 mm	155g	14	193	150	10
148089	15 mm	200g	15	201	150	10
148099	16 mm	210g	16	270	120	10
148109	17 mm	220g	17	228	120	10
148119	18 mm	270g	18	240	100	10
148129	19 mm	296g	19	245	100	5

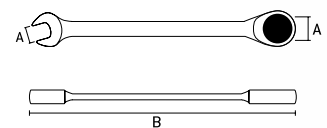

Chave Combinada com catraca articulada

Combination wrench with articulated ratchet | Llave Combinada con trinquete articulado



- Cabeça móvel com catraca reversível | Reversible ratchet head | Cabeza móvil con trinquete reversible
- Acabamento Cromado | Chrome Finish | Acabado Cromado

	DIMENSÕES SIZE TAMAÑO (MM)	Quant. Min.	DIMENSÕES SIZE TAMAÑO (MM)		Quant. Min.	
			A	B		
148609	8 mm	78g	8	147	240	10
148629	10 mm	105g	10	162	240	10
148649	12 mm	138g	12	170	200	10
148659	13 mm	155g	13	180	200	10
148669	14 mm	160g	14	240	150	10
148699	17 mm	240g	17	283	120	10
148719	19 mm	330g	19	247	100	5

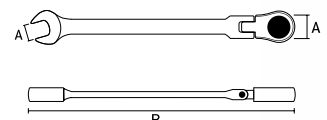

Jogo de Chave Fixa

Combination Key Set | Juego de Llave combinada



Código	Quantidade	Peso	DIMENSÕES SIZE TAMAÑO (MM)		Quant. Min.
			A	B	
152319	6 pçs 6mm - 17mm	342g	110	158	10
152769	8 pçs 6mm - 22mm	641g	141	192	8

CrV
Alta
Qualidade

NORMA
DIN 3113

AUTO
SERVIÇO



• **152319 - Composição:**
06 peças de medidas:
6 x 7, 8 x 9, 10 x 11, 12 x 13,
14 x 15 e 16 x 17.

• **152769 - Composição:**
08 peças de medidas:
6x7 - 8x9 - 10x11 - 12x13 - 14x15
16x17 - 18x19 - 20x22 mm

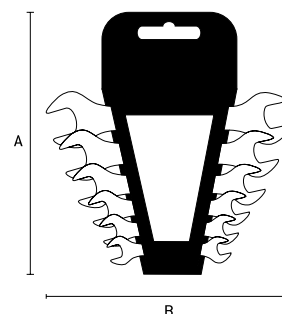

- Norma DIN 3113 | Standard DIN 3113 | Norma DIN 3113
- Acabamento Cromado | Chrome Finish | Acabado Cromado

Jogo de chave estrela

Star key set | Juego de llave estrella



Código	Quantidade	Peso	DIMENSÕES SIZE TAMAÑO (MM)		Quant. Min.
			A	B	
153319	6 pçs 6mm - 17mm	710g	112	252	5
153329	8 pçs 6mm - 22mm	1240g	154	295	0

CrV
Alta
Qualidade

NORMA
DIN 3113

AUTO
SERVIÇO



• **153319 - Composição:**
06 peças de medidas:
6x7, 8x9, 10x11, 12x13, 14x15, 16x17 mm

• **153329 - Composição:**
08 peças de medidas:
6 x 7, 8 x 9, 10 x 11, 12 x 13,
14 x 15, 16 x 17, 18 x 19, 20 x 22 mm

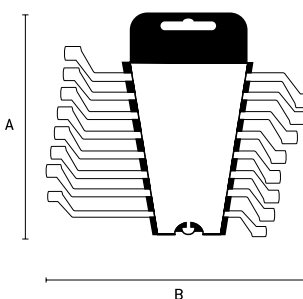

- Norma DIN 3113 | Standard DIN 3113 | Norma DIN 3113
- Para porcas profundas e rebaixadas | For deep and recessed nuts | Para tuercas profundas y rebajadas
- Ângulo de 5° para otimização de transmissão de força | Angle of 5th for power transmission optimization | Ángulo de 5° para optimización de transmisión de fuerza
- Elevada resistência a torção | High torsional resistance | Alta resistencia a la torsión

Jogo de chave Combinada

Combined key set | Juego de clave Combinada



Código	Quantidade	Peso	DIMENSÕES SIZE TAMAÑO (MM)		Quant. Min.
			A	B	
154029	6 peças parts piezas 6mm - 17 mm	390g	101	219	5
154089	8 peças parts piezas 6mm - 19mm	755g	130	228	5
154129	12 peças parts piezas 6mm - 22mm	1140g	182	258	0

CrV
Alta
Qualidade

NORMA
DIN 3113



AUTO
SERVIÇO



154029 | 6 | 8 | 10 | 13 | 14 | 17 mm

6
peças
parts | piezas

154089 | 6 | 8 | 10 | 11 | 13 | 14 | 17 | 19 mm

8
peças
parts | piezas

154129 | 6 | 7 | 8 | 9 | 10 | 11 | 12 | 13 | 14 | 17 | 19 | 22 mm

12
peças
parts | piezas



Imagem meramente ilustrativa | Merely illustrative image | Imagen meramente ilustrativa

- Norma DIN 3113 | Standard DIN 3113 | Norma DIN 3113
- Acabamento Cromo/Fosco | Chrome Finish / Frosted | Acabado Cromo / Fosco

Jogo de chave fixa

Fixed key set | Juego de llave fija

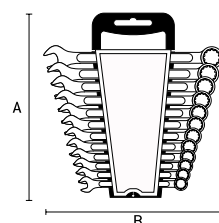

1523655	710g	DIMENSÕES SIZE TAMAÑO (MM)		40	Quant. Min.
		A	B		

Composição | 6X7 | 8X9 | 10X11 | 12X13 | 14X15 | 16X17mm

- CrV Alta Qualidade
- AUTO SERVIÇO
- NORMA DIN 3113



6 peças
parts | piezas

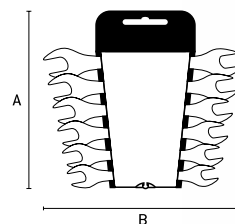

• Aço CrV Temperado de alta qualidade | High Quality Tempered CrV Steel | Acero CrV Templado de alta calidad

Jogo de chave fixa

Fixed key set | Juego de llave fija



1523855	1240g	DIMENSÕES SIZE TAMAÑO (MM)		20	Quant. Min.
		A	B		

Composição | 6X7 | 8X9 | 10X11 | 12X13 | 14X15 | 16X17 | 18X19 | 20X22mm

- CrV Alta Qualidade
- AUTO SERVIÇO
- NORMA DIN 3113



8 peças
parts | piezas

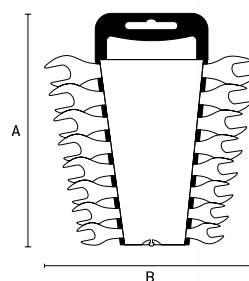

• Aço CrV Temperado de alta qualidade | High Quality Tempered CrV Steel | Acero CrV Templado de alta calidad

Jogo de chave fixa

Fixed key set | Juego de llave fija



1524255	1350g	DIMENSÕES SIZE TAMAÑO (MM)		10	Quant. Min.
		A	B		

Composição | 6X7 | 8X9 | 10X11 | 12X13 | 14X15 | 16X17 | 18X19 | 20X22 | 21X23 | 24X26 | 25X28 | 27X32mm

- CrV Alta Qualidade
- AUTO SERVIÇO
- NORMA DIN 3113



12 peças
parts | piezas

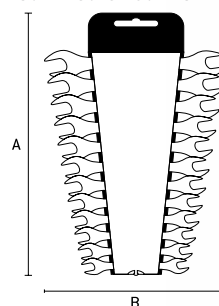

• Aço CrV Temperado de alta qualidade | High Quality Tempered CrV Steel | Acero CrV Templado de alta calidad

Jogo de chave estrela

Fixed key set | Juego de llave fija



1533155	6 peças parts piezas	710g	DIMENSÕES SIZE TAMAÑO (MM)		30	Quant. Min.
			A	B		
1533255	8 peças parts piezas	1240g	154	295	20	0
1533355	12 peças parts piezas	1350g	160	310	8	0

1533155 | 6X7 | 8X9 | 10X11 | 12X13 | 14X15 | 16X17mm

6 peças
parts | piezas

- CrV Alta Qualidade
- AUTO SERVIÇO
- NORMA DIN 3113

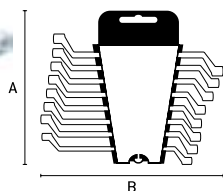

1533255 | 6X7 | 8X9 | 10X11 | 12X13 | 14X15 | 16X17 | 18X19 | 20X22mm

8 peças
parts | piezas

1533355 | 6X7 | 8X9 | 10X11 | 12X13 | 14X15 | 16X17 | 18X19 | 20X22 | 21X23 | 24X26 | 25X28 | 27X32mm

12 peças
parts | piezas

• Aço CrV Temperado de alta qualidade | High Quality Tempered CrV Steel | Acero CrV Templado de alta calidad

5

Chave Estrela de Bater



Barcode	SKU	KG	DIMENSÕES SIZE TAMAÑO (MM)			Box	Quant. Min.
			A	B	C		
1426955	24 mm	250g	20	170	46	80	2
1427155	27 mm	311g	20	187	53	80	1
1427355	30 mm	475g	20	197	55	60	2
1427455	32 mm	450g	40	205	60	60	2
1427555	36 mm	600g	22	213	66	40	2
1427655	41 mm	800g	24	240	70	30	1
1427755	46 mm	1050g	25	245	80	24	1
1427855	50 mm	1333g	26	262	87	20	1
1427955	55 mm	1583g	25	280	90	16	1
1428055	60 mm	1588g	28	282	97	16	1

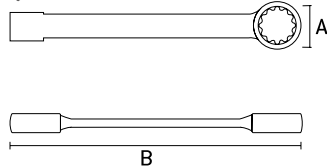

Chave Fixa de Bater



Barcode	SKU	KG	DIMENSÕES SIZE TAMAÑO (MM)			Box	Quant. Min.
			A	B	C		
1428155	24 mm	250g	20	170	46	80	2
1428255	27 mm	311g	20	187	53	80	1
1428355	30 mm	475g	20	197	55	60	2
1428455	32 mm	450g	40	205	60	60	2
1428555	36 mm	600g	22	213	66	40	2
1428655	41 mm	800g	24	240	70	30	1
1428755	46 mm	1050g	25	245	80	24	1
1428855	50 mm	1333g	26	262	87	20	1
1428955	55 mm	1583g	25	280	90	16	1
1429055	60 mm	1588g	28	282	97	16	1

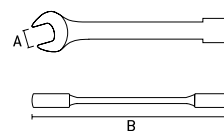

Chave Fixa, CrV, Fosfatizada



Barcode	SKU	KG	DIMENSÕES SIZE TAMAÑO (MM)			Box	Quant. Min.
			A	B	C		
1432055	6 x 7 mm	30g	20	120	20	1000	50
1432155	8 x 9 mm	40g	20	130	10	600	50
1432255	10 x 11 mm	60g	70	280	15	400	50
1432355	12 x 13 mm	80g	30	170	5	300	25
1432455	14 x 15 mm	100g	30	180	10	250	25
1432555	16 x 17 mm	140g	35	200	10	100	25
1432655	18 x 19 mm	190g	40	220	10	100	10
1432755	20 x 22 mm	230g	45	230	10	100	10
1432855	21 x 23 mm	260g	50	240	10	100	10
1432955	24 x 26 mm	350g	50	260	10	60	5
1433055	25 x 28 mm	430g	60	270	10	50	5
1433155	27 x 32 mm	580g	55	290	10	50	5
1433255	30 x 32 mm	550g	65	280	20	40	5

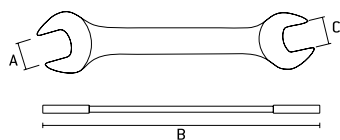

Chave Estrela, CrV, Fosfatizada



Barcode	SKU	KG	DIMENSÕES SIZE TAMAÑO (MM)			Box	Quant. Min.
			A	B	C		
1465155	6 x 7 mm	40g	25	170	10	400	50
1465255	8 x 9 mm	60g	10	190	30	300	20
1465355	10 x 11 mm	90g	10	200	30	200	20
1465455	12 x 13 mm	110g	10	220	30	200	20
1465555	14 x 15 mm	140g	10	240	35	150	10
1465655	16 x 17 mm	180g	10	270	35	100	10
1465755	18 x 19 mm	230g	20	300	40	100	10
1465855	20 x 22 mm	320g	10	330	40	60	5
1465955	21 x 23 mm	370g	10	320	45	60	5
1466055	24 x 26 mm	420g	40	350	20	60	5
1466155	25 x 28 mm	480g	40	360	20	50	5
1466255	27 x 32 mm	640g	45	370	20	40	5
1466355	30 x 32 mm	640g	45	370	20	40	5



Chave Combinada, CrV, Fosfatizada



CrV
Alta
Qualidade

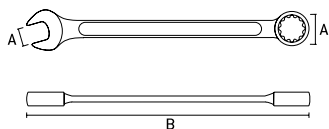

Barcode	KG	DIMENSÕES SIZE TAMAÑO (MM)	Quant. Min.				
			A	B	C		
1490155	6 mm	32g	50	160	8	300	75
1490255	7 mm	39g	50	170	8	300	75
1490355	8 mm	45g	50	170	8	240	60
1490455	9 mm	49g	50	180	10	240	60
1490555	10 mm	61g	50	190	10	200	25
1490655	11 mm	69g	50	200	10	200	25
1490755	12 mm	73g	50	200	10	200	25
1490855	13 mm	89g	50	220	12	200	25
1490955	14 mm	108g	50	220	12	200	25
1491055	15 mm	124g	50	220	12	200	25
1491155	16 mm	139g	50	240	16	120	30
1491255	17 mm	151g	50	240	17	120	30
1491355	18 mm	161g	50	240	17	120	30
1491455	19 mm	183g	50	260	17	100	25
1491555	20 mm	207g	50	260	18	100	25
1491655	21 mm	225g	50	280	20	80	20
1491755	22 mm	240g	50	280	20	80	20
1491855	23 mm	285g	50	280	20	80	20
1491955	24 mm	327g	70	305	20	60	10
1492055	25 mm	337g	70	305	20	60	10
1492155	26 mm	375g	70	305	20	60	10
1492255	27 mm	415g	70	320	22	60	10
1492355	28 mm	450g	70	320	22	40	10
1492455	29 mm	483g	70	320	22	40	10
1492555	30 mm	515g	70	360	25	40	10
1492655	32 mm	595g	70	360	25	20	5

Jogo de Chave Combinada, CrV, Fosfatizada

CrV
Alta
Qualidade



Barcode	KG	DIMENSÕES SIZE TAMAÑO (MM)	Quant. Min.				
			A	B	C		
1493055	6 x 17 mm - 6 pçs	390g	101	219	38	30	5
1493155	6 x 19 mm - 8 pçs	755g	130	228	38	20	5
1493255	6 x 22 mm - 12 pçs	1140g	182	258	40	10	1

1493055 | 6 | 8 | 10 | 13 | 14 | 17 mm

6 peças
para 1 peça



1493155 | 6 | 8 | 10 | 11 | 12 | 13 | 14 | 17 | 19 mm

8 peças
para 1 peça

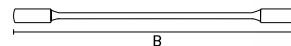

1493255 | 6 | 7 | 8 | 9 | 10 | 11 | 12 | 13 | 14 | 17 | 19 | 22 mm

12 peças
para 1 peça

Jogo de Chave Fixa, CrV, Fosfatizada

CrV
Alta
Qualidade



Barcode	KG	DIMENSÕES SIZE TAMAÑO (MM)	Quant. Min.				
			A	B	C		
1496655	6 x 17 mm - 6 pçs	1240g	154	295	35	20	1
1496755	6 x 22 mm - 8 pçs	1350g	160	310	35	20	1
1496555	6 x 32 mm - 12 pçs	710g	112	252	30	30	5

- 1496655 - Composição:
06 peças de medidas:
6 x 7, 8 x 9, 10 x 11, 12 x 13, 14 x 15, 16 x 17 mm
- 1496755 - Composição:
08 peças de medidas:
6x7, 8x9, 10x11, 12x13, 14x15, 16x17, 18x19, 20x22 mm
- 152769 - Composição:
12 peças de medidas:
6x7, 8x9, 10x11, 12x13, 14x15, 16x17, 18x19, 20x22,, 21x23, 24x26, 25x28, 27x32 mm

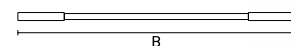
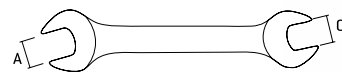

Jogo de Chave Estrela, CrV, Fosfatizada

CrV
Alta
Qualidade



Barcode	KG	DIMENSÕES SIZE TAMAÑO (MM)	Quant. Min.				
			A	B	C		
1499555	6 x 17 mm - 6 pçs	0,710	112	252	30	30	5
1499655	6 x 22 mm - 8 pçs	1,240	154	295	35	20	1
1499755	6 x 32 mm - 12 pçs	1,350	160	310	35	20	1

1499555 | 6X7 | 8X9 | 10X11 | 12X13 | 14X15 | 16X17mm

6 peças
para 1 peça



1499655 | 6X7 | 8X9 | 10X11 | 12X13 | 14X15 | 16X17 | 18X19 | 20X22 | 21X23 | 24X26 | 25X28 | 27X32mm

8 peças
para 1 peça

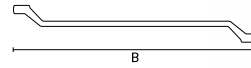

12 peças
para 1 peça

Chave Starter

Starter wrench | Llave Starter



Código	Tamanho	Peso	DIMENSÕES SIZE TAMAÑO (MM)			Quant. Min.
			A	B	C	
1452155	10 X 11 mm	100g	10	150	11	20
1452255	14 X 16 mm	170g	14	180	16	20
1452355	15 X 17 mm	170g	15	180	17	10
1452455	19 X 22 mm	290g	19	230	22	10
1452555	7/16 X 1/2"	100g	7/16"	150	1/2"	25
1452655	9/16 X 5/8"	170g	9/16"	180	5/8"	20
1452755	3/4 X 7/8"	290g	3/4"	230	7/8"	10

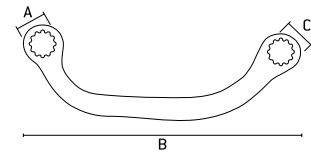

- Meia Lua | Half Moon | Media Luna
- Acabamento Fosco | Matte Finish | Acabado Mate

Jogo de chave Combinada

Combined key set | Juego de clave Combinada



Código	Quantidade	Peso	DIMENSÕES SIZE TAMAÑO (MM)		Quant. Min.
			A	B	
1540355	8 peças parts piezas	710g	112	252	0
1540555	12 peças parts piezas	1240g	154	295	0
1540755	15 peças parts piezas	1350g	160	310	0

1540355 | 8 | 9 | 10 | 11 | 12 | 13 | 14 | 17mm



1540555 | 6 | 7 | 8 | 9 | 10 | 11 | 12 | 13 | 14 | 17 | 19 | 22 mm



1540755 | 6 | 7 | 8 | 10 | 11 | 12 | 13 | 14 | 17 | 19 | 22 | 24 | 27 | 30 | 32mm



Imagem meramente ilustrativa | Merely illustrative image | Imagen meramente ilustrativa

Cinta para amarração de carga

Load lashing strap | Cinta de amarre de carga



Código	Peso	DIMENSÕES SIZE TAMAÑO (MM)		Quant. Min.
		A	B	
5440355	1450g	220	300	0

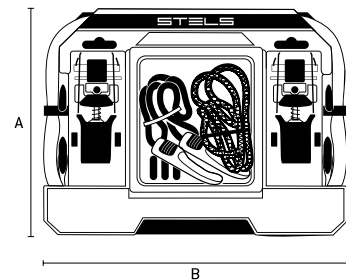

- O kit inclui 2 elásticos com gancho de Ø 0,8 x 0,6 m e Ø 0,8 x 0,8 m e 2 cintas de planas com gancho e catraca de fixação 0,025 mm x 4,50 m | The kit includes 2 elastics with hook of Ø 0,8 x 0,6 m and Ø 0,8 x 0,8 m and 2 straps of flat with hook and ratchet of fixation 0,025 mm x 4,50 m | El kit incluye 2 elásticos con gancho de Ø 0,8 x 0,6 m y Ø 0,8 x 0,8 m y 2 cintas de planas con gancho y trinquete de fijación 0,025 mm x 4,50 m

Cinta para amarração de carga

Load lashing strap | Cinta de amarre de carga



Código	Capacidade	Peso	DIMENSÕES SIZE TAMAÑO (MM)		Quant. Min.
			A	B	
543655	Capacidade Capacity 700Kg - 0,38X5MT	917g	110	320	0
543665	Capacidade Capacity 1000Kg - 0,38X10MT	1250g	160	350	0

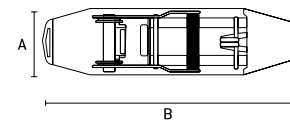

Macaco Hidráulico tipo jacaré 3T

Alligator Type Hydraulic Jack | Gato hidráulico tipo jacaré



5101055	3t/altura min.130 - max.490mm	29,5kg	DIMENSÕES SIZE TAMAÑO (MM)		1	0
			A	B		

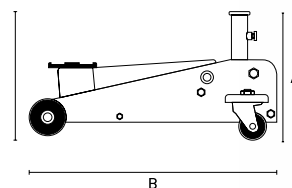

altura min.130mm - max.490mm

- Acompanha cabo | Accompany cable | Acompaña cable
- Embalagem: Caixa Individual | Packing: Individual carton | Embalaje: Caja Individual

Macaco Hidráulico tipo jacaré 2T

Alligator Type Hydraulic Jack | Gato hidráulico tipo jacaré



5100855	2t/altura min.135 - max.300mm	7,5kg	DIMENSÕES SIZE TAMAÑO (MM)		1	0
			A	B		

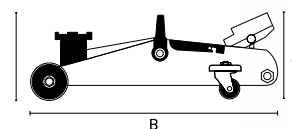

altura min.135 mm - max.300 mm

- Acompanha cabo | Accompany cable | Acompaña cable
- Embalagem: Caixa Individual | Packing: Individual carton | Embalaje: Caja Individual

Macaco Hidráulico tipo jacaré

Alligator Type Hydraulic Jack | Gato hidráulico tipo jacaré



Reforçado com 2 bombas
Reinforced with 2 pumps
Reforzado con 2 bombas

5113355	3 t / altura min.135 - max.465 mm	33,5Kg	DIMENSÕES SIZE TAMAÑO (MM)		1	0
			A	B		
5113555	3,5 t / altura min.100 - max.565 mm	47Kg	A	B	1	0

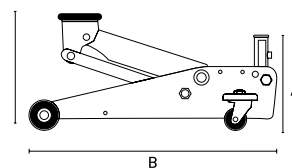

51133 : altura min.135 mm - max.465 mm
51135: altura min.100mm - max.565 mm

- Acompanha cabo | Accompany cable | Acompaña cable
- Embalagem: Caixa Individual | Packing: Individual carton | Embalaje: Caja Individual

Macaco Hidráulico tipo jacaré 2T

Alligator Type Hydraulic Jack | Gato hidráulico tipo jacaré



510289	2 t/altura min.135 - max.385 mm	12,8Kg	DIMENSÕES SIZE TAMAÑO (MM)		1	0
			A	B		

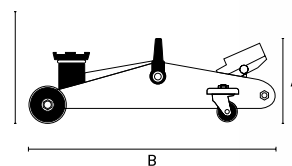

altura min.135mm - max.385 mm

- Portátil | Portable | Portátil
- Acompanha cabo | Accompany cable | Acompaña cable
- Embalagem: Caixa Individual | Packing: Individual carton | Embalaje: Caja Individual

5

Macaco Hidráulico tipo garrafa

Bottle type hydraulic jack | Gato hidráulico tipo botella



- 1 estágio | 1 stage | 1 prática
- Com válvula de segurança (para evitar elevação superior a sua capacidade) | With safety valve (to avoid elevation exceeding its capacity) | Con válvula de seguridad (para evitar elevación superior a su capacidad)
- Usar e armazenar somente na posição vertical | Use and store only in upright position | Utilizar y almacenar solamente en posición vertical
- Acompanha cabo | Accompany cable | Acompaña cable
- Embalagem: Caixa Individual | Packing: Individual carton | Embalaje: Caja Individual

NOVO	SSC	KG	DIMENSÕES SIZE TAMAÑO (MM)		Quant. Min.	
			A	B		
5032155		2,19Kg	153	107	10	0
5032255		2,33Kg	185	120	5	0
5032355		3,62Kg	200	125	5	0
5032455		4,95Kg	205	130	4	0
5032555		5,55Kg	210	130	4	0

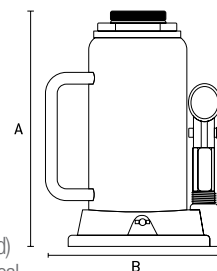

Saca polias

Remove pulleys | Saca poleas



- GARRAS ARTICULADAS | ARTICULATED CLAMPS | GARRAS ARTICULADAS
- Cromada | Chrome plated | cromo
- Uso Leve | Light use | Uso Ligero
- Embalagem: Caixa | Packing: carton | Embalaje: Caja

NOVO	SSC	KG	DIMENSÕES SIZE TAMAÑO (MM)		Quant. Min.	
			A	B		
5253055		436g	55	100	50	0
5253555		750g	60	150	36	0

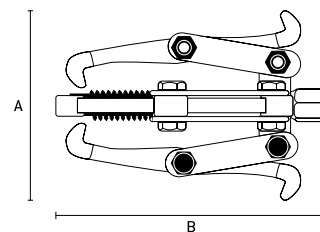

Chave de corrente

Power switch | Llave de corriente



- Tipo leve | Light type | Tipo ligero
- Para filtros | For filters | Para filtros
- Cabo plástico | Plastic cable | Cable de plástico
- Capacidade: 5-125mm | Capacity: 5-125mm | Capacidad: 5-125mm

NOVO	SSC	KG	DIMENSÕES SIZE TAMAÑO (MM)		Quant. Min.	
			A	B		
5282055		303g	80	125	80	10

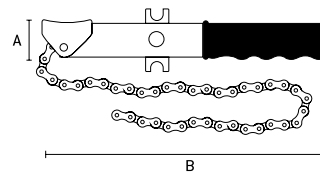

Almotolia metálica

Metal almotolia | Almotolia metálica



- Bomba para óleo | Oil pump | Bomba de aceite
- Bico Flexível regulável | Adjustable Flexible Nozzle | Boquilla flexible regulable
- Corpo metálico | Metal body | Cuerpo metálico

NOVO	SSC	KG	DIMENSÕES SIZE TAMAÑO (MM)		Quant. Min.	
			A	B		
5313055		210g	125	70	50	10

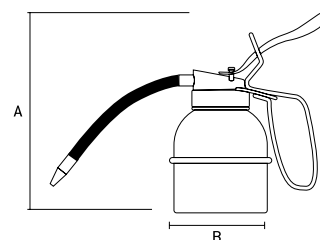

Chave de Teste

Test Key | Clave de prueba



		DIMENSÕES SIZE TAMAÑO (MM)			
5552055	6 - 24V	A	B	250	10

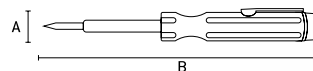

Ideal para identificar cabos rompidos, fusíveis queimados
Ideal for identifying broken cables, blown fuses
Ideal para identificar cables rotos, fusibles quemados

- Corpo plástico | Plastic body | Cuerpo plástico
- Corpo para aterramento | Body for grounding | Cuerpo para puesta a tierra
- Indicado para teste de tensão CC | Suitable for CC voltage test | Indicado para prueba de tensión CC

Funil plástico

Plastic funnel | Embudo plástico



		DIMENSÕES SIZE TAMAÑO (MM)			
5372059	130g	A		150	0

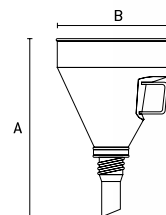

- Flexível | Flexible | Flexible
- Com peneira e alça | With sieve and handle | Con criba y alza
- Diâmetro: 120mm | Diameter: 120mm | Diámetro: 120mm

Abraçadeira rosca sem fim

Endless threaded clamp | Abrazadera rosca sin fin



5400255	8 - 18 mm	31g	500	0
5400455	11 - 20 mm	32g	500	0
5400655	13 - 23 mm	33g	500	0
5400855	14 - 27 mm	34g	500	0
5401055	18 - 25 mm	36g	500	0

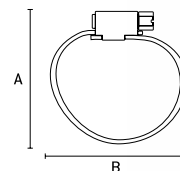

- Aço carbono galvanizado | Carbon steel, galvanized | Acero al carbono galvanizado
- Embalagem com 5 peças | Pack of 5 pieces | Embalaje con 5 piezas

Rodo multiuso

Multipurpose wheel | Rodo multiuso



			DIMENSÕES SIZE TAMAÑO (MM)			
5521855	20cm	126g	A	B	80	20
5521955	16cm	99g	160	260	80	20
5522155	22cm	113g	217	260	80	20

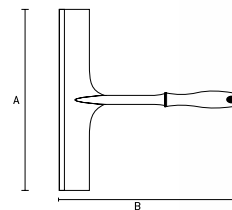

Cabo para Transmissão de Carga de Bateria



5591755	Fio 2,5 mm (200 amperes)	700g	20	0
5591955	Fio 3,0 mm (300 amperes)	955g	20	0

5

Filtro de Purificador / Secador de ar

Compressed air filter | Filtro de aire comprimido



570089	1/4"	115g	DIMENSÕES SIZE TAMAÑO (MM)		100	0
			A	B		
			40	90		

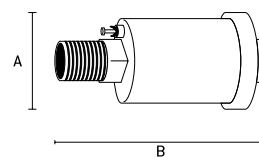

Aplicação
Application
Aplicación

- **Uso profissional** | Professional use | Uso profesional
- **Indicado para retirada de umidade do ar acumulado na mangueira** | Suitable for removing moisture from the air entering the compressor | Indicado para retirar la humedad del aire que entra en el compresor
- **Rosca de 1/4" | 1/4" thread | Rosca de 1/4"**
- **Acessório para todas as ferramentas pneumáticas** | Accessory for all pneumatic tools | Accesorio para todas las herramientas neumáticas
- **Embalagem: caixa** | Packing: Carton | Embalaje: caja

Jogo de engate rápido

Quick coupling kit | Juego de acoplamiento rápido



5701655	1/4" NPT	100g	DIMENSÕES SIZE TAMAÑO (MM)		100	50
			A	B		
			20	45		



BLISTER

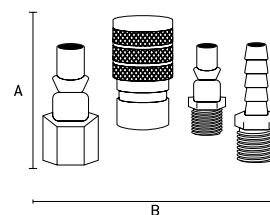

- **Uso profissional e industrial** | Professional and industrial use | Uso profesional e industrial
- **Composição: 4 peças** | Composition: 4 pieces | Composición: 4 piezas

Mangueira espiral de ar

Spiral air hose | Manguera espiral de aire



5700455	1/4" NPT Rosca/Screw/tornillo	340g	DIMENSÕES SIZE TAMAÑO (MM)		50	0
			A	B		
			80	350		
5700555	1/4" NPT Engate rápido Quick coupling/Enganche rápido	340g	DIMENSÕES SIZE TAMAÑO (MM)		50	0
			A	B		
			80	350		

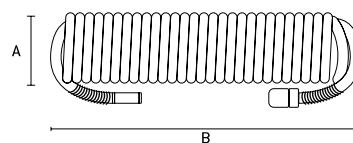

- **Tamanho: 10 metros** | Size: 10 meters | Tamaño: 10 metros

Calibrador de Pneus

Tire Calibrator | Calibrador de Neumáticos



5732255

410g

DIMENSÕES | SIZE | TAMAÑO (MM)
A 290 B 150

40

Quant. Min. 10

AUTO SERVIÇO

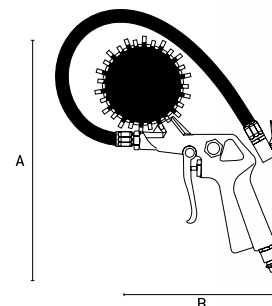

- Mangueira Flexível | Flexible hose | Manguera Flexible
- Bico prendedor para fácil operação | Nipple catch for easy operation | Boquilla prendedor para fácil operación
- Válvula de alívio de pressão | Pressure Relief Valve | Válvula de alívio de presión
- Manômetro para monitoramento de pressão | Pressure gauge for pressure monitoring | Manómetro para monitoreo de presión
- Rosca de 1/4" NPT | 1/4" NPT Thread | Rosca de 1/4" NPT
- Pressão de trabalho 7 BAR (100 PSI)

Jogo de acessórios para compressores

Accessory set for compressors | Juego de accesorios para compresores



5730255
5730455

5pçs, engate rápido
5pçs, engate rápido

DIMENSÕES | SIZE | TAMAÑO (MM)
A 440 B 470
A 450 B 475

10
10

Quant. Min. 0
Quant. Min. 0



- 5730255
- 1 Pistola de pintura tanque baixo com reservatório de alumínio;
- 1 Pistola para limpeza bico curto;
- 1 Mangueira de ar de 5 metros;
- 1 Calibrador de pneus com manômetro;
- 1 Pistola pulverizadora tanque baixo com bico longo e reservatório de alumínio.

- 5730455
- 1 Pistola de pintura tanque alto com reservatório plástico;
- 1 Pistola para limpeza bico curto;
- 1 Mangueira de ar de 5 metros;
- 1 Calibrador de pneus com manômetro;
- 1 Pistola pulverizadora tanque baixo com bico longo e reservatório de alumínio.

- Pressão de trabalho 7 BAR (100 PSI)
- Pistola para limpeza | Cleaning Pistol | Pistola para limpieza
- Mangueira de ar espiral engate rápido | Spiral air hose quick coupling | Manguera de aire espiral acoplamiento rápido
- Calibrador de pneus | Tire gauge | Calibrador de neumáticos
- Pistola de limpeza bico longo | Long Beak Cleaning Gun | Pistola de limpieza largo largo

5

Pistola de limpeza

Cleaning gun | Pistola de limpieza

AUTO
SERVIÇO



5733055



encaixe rosca 1/4"



170g

DIMENSÕES | SIZE | TAMAÑO (MM)

A

B



100



Quant. Min.
25

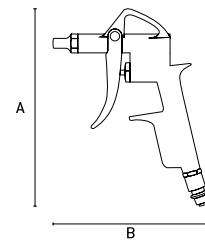

- Curta | Plastic tank top gun | Pistola tanque alto de plástico
- Corpo em alumínio | Cleaning Pistol | Pistola para limpieza
- Acionamento por gatilho | Spiral air hose | Manguera de aire espiral
- Rosca 1/4" NPT | Screw thread | Tornillo
- Pressão de trabalho 7 BAR (100 PSI)

Pistola de limpeza

Cleaning gun | Pistola de limpieza

AUTO
SERVIÇO



5733255



encaixe rosca 1/4"



270g

DIMENSÕES | SIZE | TAMAÑO (MM)

A

B



40



Quant. Min.
20

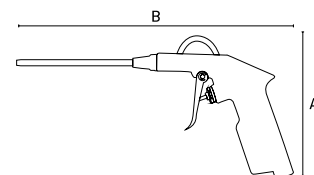

- Indicada para limpeza e secagem de peças, máquinas e equipamentos em geral | Indicated for cleaning and drying of parts, machinery and equipment in general | Indicada para limpieza y secado de piezas, máquinas y equipos en general
- Bico longo | Long beak | Boquilla larga
- Possui gatilho curto para maior praticidade no uso | It has a short trigger for greater practicality in use | Posee gatillo corto para mayor practicidad en el uso
- Corpo plástico | Plastic body | Cuerpo plástico
- Comprimento 135mm | Length 135mm | Longitud 135mm
- Rosca 1/4" NPT | Screw thread | Tornillo
- Pressão de trabalho 7 BAR (100 PSI)

Kit reparo para pistola de pintura

Repair kit for paint spray gun | Kit de reparación para pistola de pintura



Código	Bico	Peso	DIMENSÕES SIZE TAMAÑO (MM)		Quant. Min.
			A	B	
5738055	1,2mm	88g	90	170	50
5738255	1,5mm	89g	90	170	50
5738455	1,8mm	88g	90	170	50



BLISTER

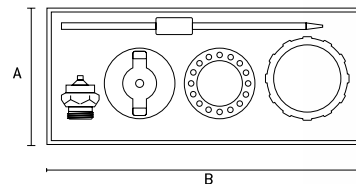

- 4 peças | 4 pieces | 4 piezas
- Bico 1,2 | Nozzle 1,2 | Bico 1,2
- Agulha | Needle | Aguja
- Bocal e abraçadeiras | Nozzle and clamps | Boquilla y abrazaderas

Pistola de jateamento de areia

Sand blasting gun | Pistola de chorro de arena



Código	Capacidade	Peso	DIMENSÕES SIZE TAMAÑO (MM)		Quant. Min.
			A	B	
5732855		1200g	270	370	0
5732655	1000ml	870g	192	253	0



AUTO SERVIÇO



• 5732855

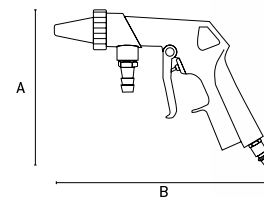

• 5732655

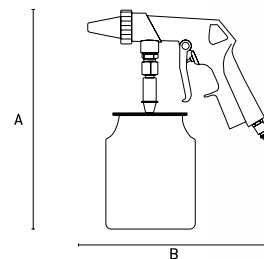

- Alimentação por sucção | Suction feeding | Alimentación por succión
- Tanque baixo | Low tank | Tanque bajo
- Pneumática | Pneumatic | Neumático
- Rosca 1/4" | Thread 1/4" | Rosca 1/4"
- Pressão de trabalho 7 BAR (100 PSI)



Pistola de pintura

Spray gun | Pistola de pintura



Barcode	Capacity	DIMENSÕES SIZE TAMAÑO (MM)		Box	Quant. Min.
		A	B		
5731455	600 ml	165	110	20	0
5731555	1000 ml	225	120	20	0
5731855	200 ml	170	60	30	0

AUTO SERVIÇO



• 5731455



• 5731555



• 5731855
Aerógrafo | Airbrush | Aerógrafo

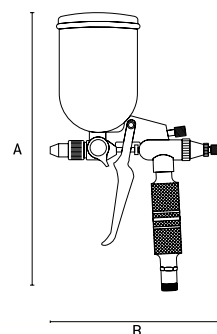
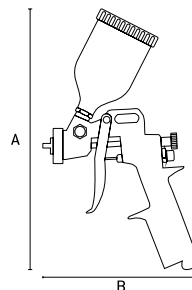

- Alimentação por gravidade | Food by gravity | Alimentación por gravedad
- Tanque alto | High tank | Tanque alto
- Rosca 1/4" | Thread 1/4" | Rosca 1/4"
- Pressão de trabalho 7 BAR (100 PSI)

Pistola de pintura

Spray gun | Pistola de pintura



Barcode	Capacity	Weight	DIMENSÕES SIZE TAMAÑO (MM)		Box	Quant. Min.
			A	B		
5731755	750ml	900g	250	165	10	1
5731655	1000ml	950g	273	190	10	1

AUTO SERVIÇO

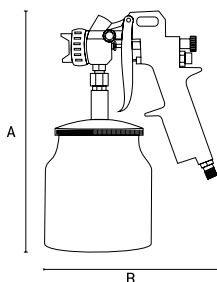

- Alimentação por sucção | Suction feeding | Alimentación por succión
- Tanque baixo | Low tank | Tanque bajo
- Rosca 1/4" | Thread 1/4" | Rosca 1/4"
- Pressão de trabalho 7 BAR (100 PSI)

STELS
VELOCIDADE, CONFIANÇA, ESTILO

AERÓGRAFO
AIRBRUSH | AERÓGRAFO



Imagem meramente ilustrativa



FERRAMENTAS DE JARDIM

Garden's Tools
Herramientas de Jardín

As ferramentas de jardim PALISAD são desenvolvidas para amadores e profissionais da área de jardinagem, para realização de trabalhos com a terra, plantas, irrigação de canteiros, jardins e hortas. Fabricadas com matérias primas de qualidade, garantem um ótimo trabalho e resultado. Oferece um pacote completo de produtos para o seu jardim.

PALISAD garden's tools are designed for amateurs and professionals of the area of gardening, to carry out works with the earth, plants, irrigation of flower beds, gardens and vegetable gardens. Made with quality raw materials, they guarantee a great work and result. Offers a complete package of products for your garden.

Las herramientas de jardín PALISAD se desarrollan para aficionados y profesionales del área de jardinería, para la realización de trabajos con la tierra, plantas, irrigación de jardines, jardines y huertos. Fabricadas con materias primas de calidad, garantizan un excelente trabajo y resultado. Ofrece un paquete completo de productos para su jardín.

SIMBOLOGIA



CÓDIGO
CODE



CARACTERÍSTICAS
Technical Features



PESO DA PEÇA
Part Weight
Peso de la Pieza



CAIXA MASTER
Box Master | Caja Máster



QUANT. MINÍMA
Quant. Minimum
Cantidad Mínimo

JARDINAGEM

GARDENING | JARDINERÍA



Serrote de poda

Pruning saw | Serrucho de poda



604118



367g

DIMENSÕES | SIZE | TAMAÑO (MM)

A	B	C
135	340	25



48



6

AUTO
SERVIÇO

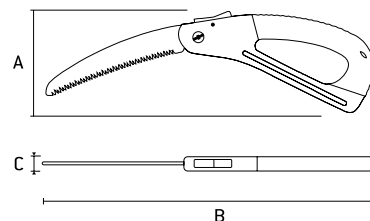

Dobrável com sistema de trava para abertura e fechamento

Folding with locking system for opening and closing | Plegable con sistema de bloqueo para apertura y cierre

- Indicado para cortar galhos secos ou verdes e tubos de PVC |

Suitable for cutting dry or green twigs and PVC pipes | Indicado para cortar ramas secas o verdes y tubos de PVC

- Cabo Plástico | Plastic Cable | Mango de plástico

- Proteção para mão | Hand protection | Protección de mano

- Dentes temperados com sistema de trava e fiação 3D |

Tempered teeth with locking system and 3D wiring | Dientes templados con sistema de trava y cableado 3D

- Embalagem: Blister | Packing: Blister | Embalaje: Blister

Serrote para galhos 350 mm / 14"

Slicer for branches | Serrucho para ramas



605818



350 mm



795g

DIMENSÕES | SIZE | TAMAÑO (MM)

A	B	C
215	430	45



24



1



BLISTER

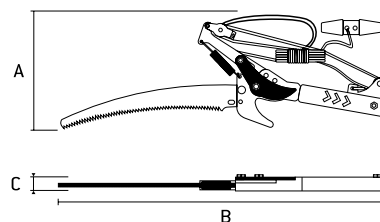

- Aço Y8 | Steel Y8 | Acero Y8

- Cordão de 2,34mt para acionamento da lâmina de corte |

2.34mt cord for cutting blade drive | Cordón de 2,34mt para accionamiento de la cuchilla de corte

- Sem cabo | Without cable | Sin Mango

- Indicado para trabalhos em jardim | Suitable for garden work | Indicado para trabajos en jardín

- Preferível usar para cortar galhos vivos de diâmetro de até 20mm, situados fora do alcance da mão |

Preferible to cut live branches up to 20mm diameter, out of reach | Preferible utilizar para cortar ramas vivas de diámetro de hasta 20mm, situados fuera del alcance de la mano

- Embalagem: Blister | Packing: Blister | Embalaje: Blister

Tesoura para cortar galhos secos e duros

Scissors for cutting hard and dry twigs | Tijeras para cortar ramas secas y duras



605328	271g	DIMENSÕES SIZE TAMAÑO (MM)			72	0*
		A	B	C		

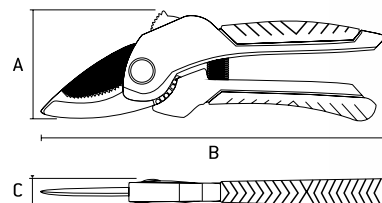

- Para cortar galhos vivos de até 22mm diâmetro | To cut live branches up to 22mm diameter | Para cortar ramas vivas de hasta 22mm de diámetro
- Aço inoxidável | Stainless steel | Acero inoxidable
- Cabo de metal emborrachado | Rubberized metal cable | Mango de metal emborrachado
- Lâmina com revestimento de teflon | Teflon coated blade | Lámina con revestimiento de teflón
- Com trava de segurança e mola | With safety lock and spring | Con traba de seguridad y resorte
- Sistema de alavanca para aumento de força em até 20% com mínimo esforço | Ratchet system for increased cutting with minimum effort | Sistema de trinquete para aumento de corte con mínimo esfuerzo
- Embalagem: Blister | Packing: Blister | Embalaje: Blister

Tesoura para Jardim

Garden Scissors | Tijera para Jardín



605368	208g	DIMENSÕES SIZE TAMAÑO (MM)			72	12
		A	B	C		
605518	208g	130	235	25	72	12



• 605368



• 605518

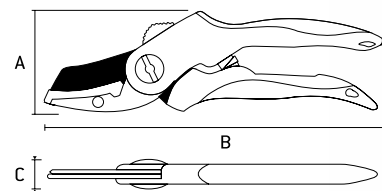
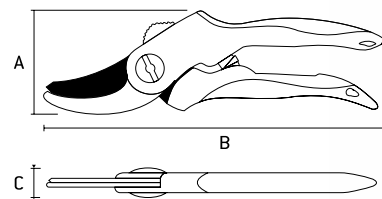

- Para cortar galhos vivos de até 15mm diâmetro | To cut live branches up to 15mm diameter | Para cortar ramas vivas de hasta 15mm de diámetro
- Aço inoxidável | Stainless steel | Acero inoxidable
- Cabo de metal emborrachado | Rubberized metal cable | Mango de metal emborrachado
- Lâmina com revestimento de teflon | Teflon coated blade | Lámina con revestimiento de teflón
- Com trava de segurança e mola | With safety lock and spring | Con traba de seguridad y resorte
- Embalagem: Blister | Packing: Blister | Embalaje: Blister



Tesoura para Jardim

Garden Scissors | Tijera para Jardín

AUTO SERVIÇO



605038	DIMENSÕES SIZE TAMAÑO (MM)			96	Quant. Min.
	A	B	C		

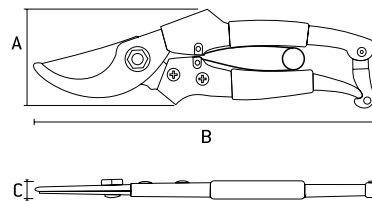

- Para cortar galhos vivos de até 15mm diâmetro | To cut live branches up to 15mm diameter | Para cortar ramas vivas de hasta 15mm de diámetro
- Aço forçado reforçado | Reinforced forged steel | Acero forzado reforzado
- Oxidado anticorrosão | Oxidized anticorrosion | Oxidado anticorrosión
- Cabo plastificado | Plastic cable | Mango plastificado
- Com trava de segurança e mola | With safety lock and spring | Con traba de seguridad y resorte
- Embalagem: Blister | Packing: Blister | Embalaje: Blister

Tesoura para Jardim

Garden Scissors | Tijera para Jardín

AUTO SERVIÇO



6054958	223g	DIMENSÕES SIZE TAMAÑO (MM)			48	Quant. Min.
		A	B	C		

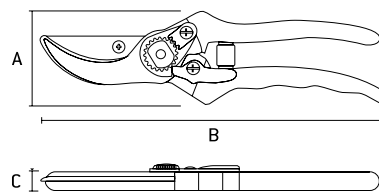

- Para cortar galhos vivos de até 15mm diâmetro | To cut live branches up to 15mm diameter | Para cortar ramas vivas de hasta 15mm de diámetro
- Aço forçado reforçado | Reinforced forged steel | Acero forzado reforzado
- Oxidado anticorrosão | Oxidized anticorrosion | Oxidado anticorrosión
- Cabo emborrachado | Rubberized | cable | Mango emborrachado
- Com trava de segurança e mola | With safety lock and spring | Con traba de seguridad y resorte
- Embalagem: Blister | Packing: Blister | Embalaje: Blister

Tesoura para galhos até 25mm

Scissor for branches up to 25mm | Tijeras para ramas hasta 25mm

AUTO SERVIÇO



605618	333g	DIMENSÕES SIZE TAMAÑO (MM)			48	Quant. Min.
		A	B	C		

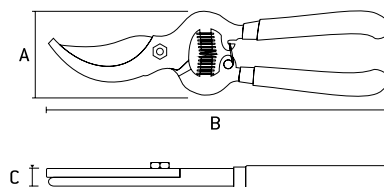

- Podas em Geral | General Pruning | Podras en General
- Lâminas temperadas e bem afiadas | Blades tempered and well honed | Láminas templadas y bien afiladas
- Aço inoxidável | Stainless steel | Acero inoxidable
- Cabo de metal emborrachado | Rubberized metal cable | Mango de metal emborrachado
- Com trava de segurança e mola | With safety lock and spring | Con traba de seguridad y resorte
- Embalagem: Blister | Packing: Blister | Embalaje: Blister

Tesouras corta galhos até Ø25mm

Scissors cuts branches up to Ø25mm | Tijeras corta ramas hasta Ø25mm



605068



1250g

DIMENSÕES | SIZE | TAMAÑO (MM)

A

B

C



12



0

AUTO SERVIÇO

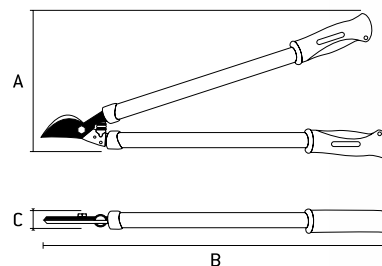

- Aço inoxidável | Stainless steel | Acero inoxidable
- Lâminas temperadas e bem afiadas | Blades tempered and well honed | Láminas templadas y bien afiladas
- Cabo de metal emborrachado | Rubberized metal cable | Mango de metal emborrachado
- Lâmina com revestimento de teflon | Teflon coated blade | Lámina con revestimiento de teflón

Tesouras corta galhos até Ø25mm

Scissors cuts branches up to Ø25mm | Tijeras corta ramas hasta Ø25mm



605218



813g

DIMENSÕES | SIZE | TAMAÑO (MM)

A

B

C



12



0

AUTO SERVIÇO

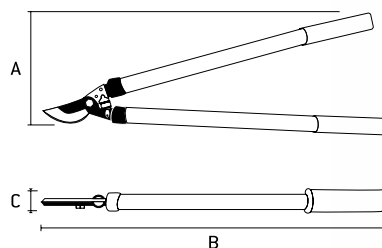

- Aço inoxidável | Stainless steel | Acero inoxidable
- Cabo de metal emborrachado | Rubberized metal cable | Mango de metal emborrachado
- Lâmina com revestimento de teflon | Teflon coated blade | Lámina con revestimiento de teflón

Tesouras corta galhos até Ø35mm

Scissors cuts branches up to Ø35mm | Tijeras corta ramas hasta Ø35mm



605228



1580g

DIMENSÕES | SIZE | TAMAÑO (MM)

A

B

C



10



0

AUTO SERVIÇO

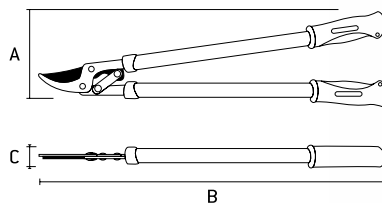

- Aço inoxidável | Stainless steel | Acero inoxidable
- Lâminas temperadas e bem afiadas | Blades tempered and well honed | Láminas templadas y bien afilada
- Cabo de metal emborrachado | Rubberized metal cable | Mango de metal emborrachado
- Lâmina com revestimento de teflon | Teflon coated blade | Lámina con revestimiento de teflón
- Mecanismo de alavanca | Lever mechanism | Mecanismo de palanca



Tesoura para Grama 310mm

Scissors for Grass 310mm | Tijeras para Hierba 310mm



608308	211g	DIMENSÕES SIZE TAMAÑO (MM)			36	Quant. Min.
		A	B			

AUTO SERVIÇO

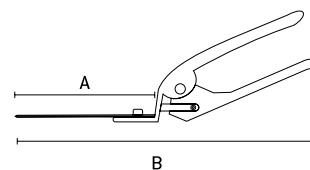

- **Aço forjado** | General Pruning | Podras en General
- **É projetada para cortar grama em gramados e canteiros de flores pequenos** | It is designed to mow grass on lawns and small flower beds | Está diseñada para cortar pasto en césped y canteros de flores pequeñas
- **Revestimento aço especial oxidado para impedir o processo de corrosão** | Special oxidized steel coating to prevent the corrosion process | Revestimiento de acero especial oxidado para impedir el proceso de corrosión
- **Cabo de metal** | Metal cable | Cable de metal

Tesoura para Grama 560mm

Scissors for Grass 560mm | Tijeras para Hierba 560mm



608368	1167g	DIMENSÕES SIZE TAMAÑO (MM)			12	Quant. Min.
		A	B	C		

AUTO SERVIÇO

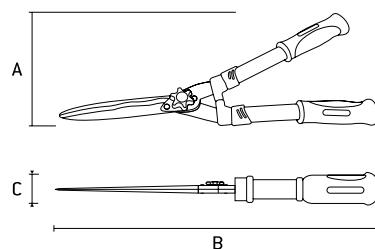

- **Lâminas de aço forjado onduladas** | Corrugated Forged Steel Blades | Láminas de acero forjado onduladas
- **Revestimento anticorrosão (lâminas)** | Anti-corrosion coating (blades) | Revestimiento anticorrosión (lâminas)
- **Cabo plástico revestido de borracha termoplástica** | Thermoplastic rubber coated plastic cable | Cable plástico revestido de goma termoplástica
- **Protetor plástico de fechamento** | Plastic Closure Protector | Protector plástico de cierre

Tesoura para Grama 520mm

Scissors for Grass 520mm | Tijeras para Hierba 520mm



6083758	917g	DIMENSÕES SIZE TAMAÑO (MM)			24	Quant. Min.
		A	B	C		

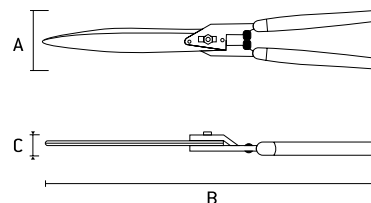

- **Lâminas de aço forjado** | Forged Steel Blades | Láminas de acero forjado
- **Tratamento anticorrosão (lâminas)** | Anti-corrosion treatment (slides) | Tratamiento anticorrosión (lâminas)
- **Cabo de madeira** | Wooden handle | Mango de madera
- **Protetor plástico de fechamento** | Plastic Closure Protector | Protector plástico de cierre

Ancinho / Rastelo 5 dentes

Creep / Rake | Rastrillo / Rizo



617778



244g

DIMENSÕES | SIZE | TAMAÑO (MM)

A

B

C



72



Quant. Min.

6*

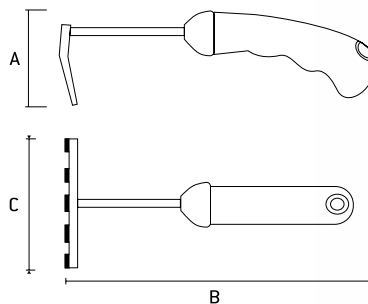

- 5 dentes | 5 teeth | 5 dientes
- Cabo Plástico ABS de dois componentes ergonômico | Cable Plástico ABS de dos componentes ergonómico
- Corpo metálico com pintura anticorrosão | Metal body with anti-corrosion paint | Cuerpo metálico con pintura anticorrosión

Ancinho / Rastelo 3 dentes

Creep / Rake | Rastrillo / Rizo



623758



226g

DIMENSÕES | SIZE | TAMAÑO (MM)

A

B

C



72



Quant. Min.

6*

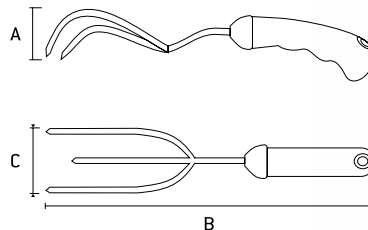

- 3 dentes | 3 teeth | 3 dientes
- Cabo dois componentes ergonômico | Ergonomic two-component cable | Mango dos componentes ergonómicos
- Corpo metálico com pintura anticorrosão | Metal body with anti-corrosion paint | Cuerpo metálico con pintura anticorrosión

Ancinho / Rastelo 3 dentes

Creep / Rake | Rastrillo / Rizo



623858



147g

DIMENSÕES | SIZE | TAMAÑO (MM)

A

B

C



72



Quant. Min.

12

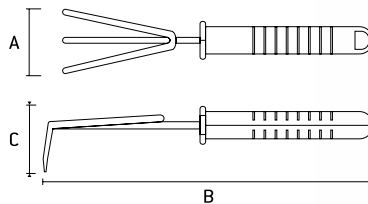

- 3 dentes | 3 teeth | 3 dientes
- Cabo plástico | Plastic cable | Mango de plástico
- Corpo metálico com pintura anticorrosão | Metal body with anti-corrosion paint | Cuerpo metálico con pintura anticorrosión

Garfo 3 dentes

Fork | Tenedor



623878



111g

DIMENSÕES | SIZE | TAMAÑO (MM)

A

B

C



72



Quant. Min.

12

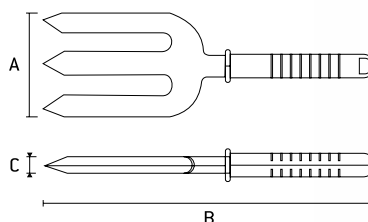

- 3 dentes | 3 teeth | 3 dientes
- Cabo plástico | Plastic cable | Mango de plástico
- Corpo metálico com pintura anticorrosão | Metal body with anti-corrosion paint | Cuerpo metálico con pintura anticorrosión



Extrator de ervas

Herbal extractor | Extractor de hierbas



623218



194g

DIMENSÕES | SIZE | TAMAÑO (MM)

A

B

C



72



6*

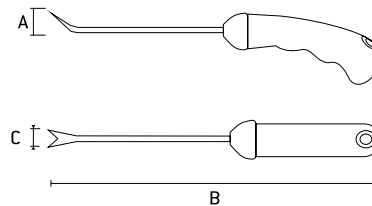

- Cabo dois componentes ergonômico | Ergonomic two-component cable | Mango dos componentes ergonômicos
- Corpo metálico com pintura anticorrosão | Metal body with anti-corrosion paint | Cuerpo metálico con pintura anticorrosión

Extrator de ervas daninhas

Weed extractor | Extractor de malas hierbas



623868



122g

DIMENSÕES | SIZE | TAMAÑO (MM)

A

B

C



72



12

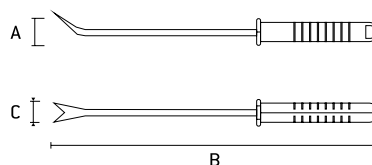

- Cabo plástico | Plastic cable | Mango de plástico
- Corpo metálico com pintura anticorrosão | Metal body with anti-corrosion paint | Cuerpo metálico con pintura anticorrosión

Pazinha

Little Shovel | Pequeña pala



626458



272g

DIMENSÕES | SIZE | TAMAÑO (MM)

A

B

C



72



6*

626478

larga

250g

60

320

75

72

6*

estreita

60

300

65

72

6*

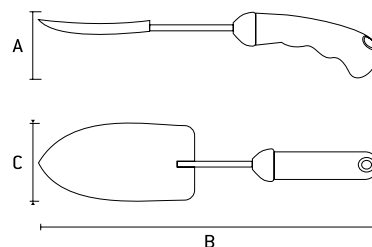

- Cabo dois componentes ergonômico | Ergonomic two-component cable | Mango dos componentes ergonômicos
- Corpo metálico com pintura anticorrosão | Metal body with anti-corrosion paint | Cuerpo metálico con pintura anticorrosión

Pazinha estreita

Little paw | Pala estrecha



626528



118g

DIMENSÕES | SIZE | TAMAÑO (MM)

A

B

C



72



12

626518

larga

99g

40

250

85

72

12

estreita

33

250

60

72

12

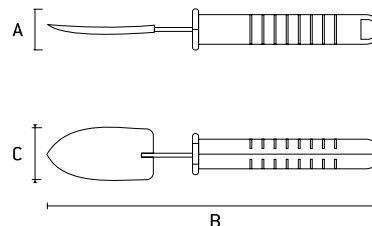

- Cabo plástico | Plastic cable | Mango de plástico
- Corpo metálico com pintura anticorrosão | Metal body with anti-corrosion paint | Cuerpo metálico con pintura anticorrosión

Sacho combinado duas pontas

Hoe combined two ends | Azada combinado duas extremidades



623778



266g

DIMENSÕES | SIZE | TAMAÑO (MM)

A

B

C



72



Quant. Min. 6*

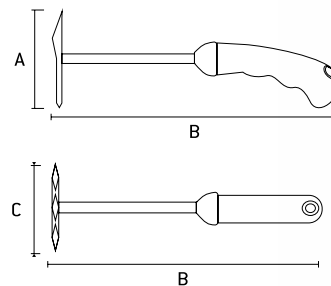

- Cabo dois componentes ergonômico | Ergonomic two-component cable | Mango dos componentes ergonômicos
- Corpo metálico com pintura anticorrosão | Metal body with anti-corrosion paint | Cuerpo metálico con pintura anticorrosión

Sacho combinado duas pontas

Hoe combined two ends | Azada combinado duas extremidades



623898



208g

DIMENSÕES | SIZE | TAMAÑO (MM)

A

B

C



72



Quant. Min. 12

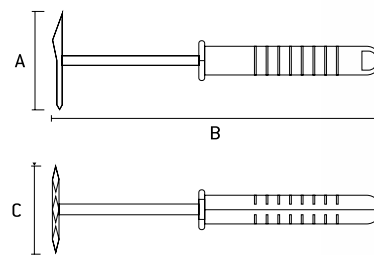

- Cabo plástico | Plastic cable | Mango de plástico
- Corpo metálico com pintura anticorrosão | Metal body with anti-corrosion paint | Cuerpo metálico con pintura anticorrosión

Enxadinha

Small hoe | Azada pequeno



623888



222g

DIMENSÕES | SIZE | TAMAÑO (MM)

A

B

C



72



Quant. Min. 12

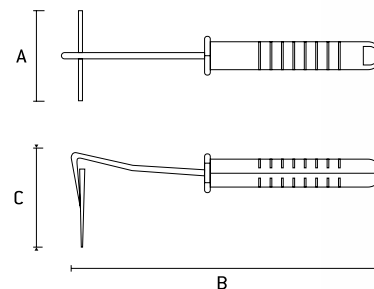

- Cabo plástico | Plastic cable | Mango de plástico
- Corpo metálico com pintura anticorrosão | Metal body with anti-corrosion paint | Cuerpo metálico con pintura anticorrosión



Vassoura para grama e jardim 22 dentes

Grass and garden broom | Escoba para césped y jardín



- Metálica | Metallic | Metálico
- Fixo | Fixed | Fijo
- Sem Cabo | Without cable | Sin Cable

			DIMENSÕES SIZE TAMAÑO (MM)				
617708	22 dentes	300g	A	B	C	30	0

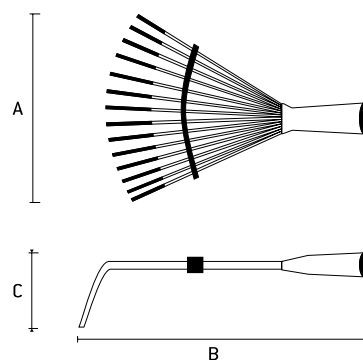

Ancinho / Rastelo

Creep / Rake | Rastrillo / Rizo



- 5 dentes | 5 teeth | 5 dientes
- Cabo de madeira | Wooden handle | Mango de madera
- Corpo metálico com pintura anticorrosão | Metal body with anti-corrosion paint | Cuerpo metálico con pintura anticorrosión

			DIMENSÕES SIZE TAMAÑO (MM)				
617558		194g	A	B	C	72	0

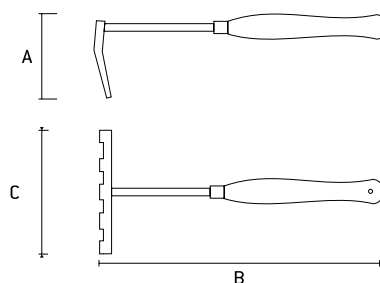

Pazinha

Little Shovel | Pequeña pala



- Cabo de madeira | Wooden handle | Mango de madera
- Corpo metálico com pintura anticorrosão | Metal body with anti-corrosion paint | Cuerpo metálico con pintura anticorrosión

			DIMENSÕES SIZE TAMAÑO (MM)				
626058	larga	250g	A	B	C	72	0
626068	estreita	264g	100	360	90	72	0

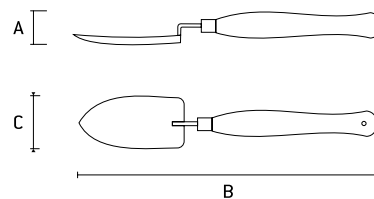

Sacho combinado duas pontas

Hoe combined two ends | Azada combinado duas extremidades



- Cabo de madeira | Wooden handle | Mango de madera
- Corpo metálico com pintura anticorrosão | Metal body with anti-corrosion paint | Cuerpo metálico con pintura anticorrosión

			DIMENSÕES SIZE TAMAÑO (MM)				
623158		168g	A	B	C	72	0

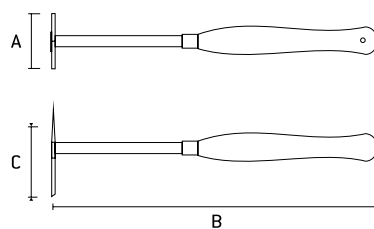

Escardilho

Spud | Escardilho



623538



147g

DIMENSÕES | SIZE | TAMAÑO (MM)

A

B

C



72



Quant. Min.

0

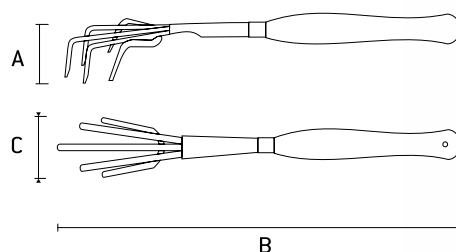

• Cabo de madeira | Wooden handle | Mango de madera

• Corpo metálico com pintura anticorrosão | Metal body with anti-corrosion paint | Cuerpo metálico con pintura anticorrosión

Pazinha

Little Shovel | Pequeña pala



630018
630028



214g
188g

DIMENSÕES | SIZE | TAMAÑO (MM)

A

B

C



96



Quant. Min.

0

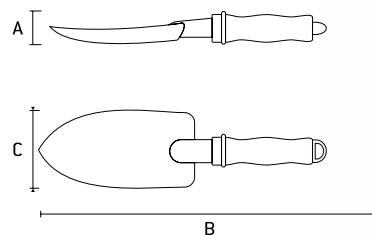

• Cabo de anatômico emborrachado | Rubberized anatomical handle | Mango de anatômico emborrachado

• Pode ser utilizado cabo extensor (630168 e 6030178) | Extender cable (630168 and 6030178) | Se puede utilizar el cable extensor (630168 y 6030178)

• Corpo metálico com pintura anticorrosão | Metal body with anti-corrosion paint | Cuerpo metálico con pintura anticorrosión

Ancinho / Rastelo

Creep / Rake | Rastrillo / Rizo



630038



204g

DIMENSÕES | SIZE | TAMAÑO (MM)

A

B

C



96



Quant. Min.

0

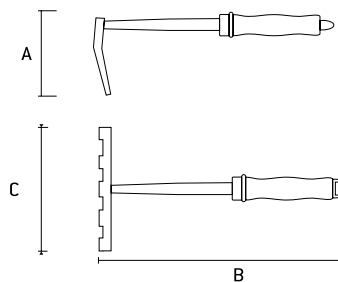

• 5 dentes | 5 teeth | 5 dientes

• Cabo de anatômico emborrachado | Rubberized anatomical handle | Mango de anatômico emborrachado

• Pode ser utilizado cabo extensor (630168 e 6030178) | Extender cable (630168 and 6030178) | Se puede utilizar el cable extensor (630168 y 6030178)

• Corpo metálico com pintura anticorrosão | Metal body with anti-corrosion paint | Cuerpo metálico con pintura anticorrosión

Sacho combinado duas pontas

Hoe combined two ends | Azada combinado duas extremidades



630058



255g

DIMENSÕES | SIZE | TAMAÑO (MM)

A	B	C
180	282	86



96



0



- 630058
Grafo de 2 dentes e enxada |
2-tooth graph and spade |
Grafo de 2 dientes y azada

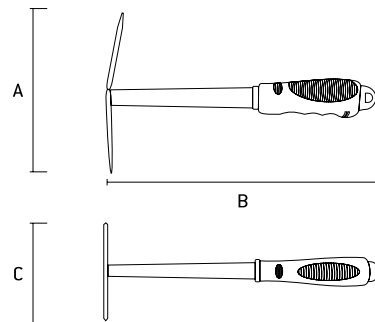

- Cabo de anatômico emborrachado | Rubberized anatomical handle | Mango de anatômico emborrachado
- Pode ser utilizado cabo extensor (630168 e 6030178) | Extender cable (630168 and 6030178) | Se puede utilizar el cable extensor (630168 y 6030178)
- Corpo metálico com pintura anticorrosão | Metal body with anti-corrosion paint | Cuerpo metálico con pintura anticorrosión

Ancinho / Rastelo

Creep / Rake | Rastrillo / Rizo



630088



197g

DIMENSÕES | SIZE | TAMAÑO (MM)

A	B	C
40	340	70



96



0*

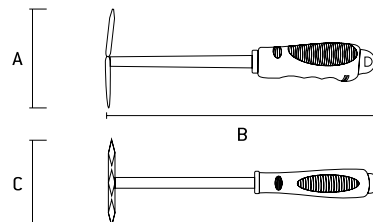

- 3 dentes | 3 teeth | 3 dientes
- Cabo de anatômico emborrachado | Rubberized anatomical handle | Mango de anatômico emborrachado
- Pode ser utilizado cabo extensor (630168 e 6030178) | Extender cable (630168 and 6030178) | Se puede utilizar el cable extensor (630168 y 6030178)
- Corpo metálico com pintura anticorrosão | Metal body with anti-corrosion paint | Cuerpo metálico con pintura anticorrosión

Vassoura para grama e jardim

Grass and garden broom | Escoba para césped y jardín



630078



9 dentes



221g

DIMENSÕES | SIZE | TAMAÑO (MM)

A	B	C
40	415	115



96



0

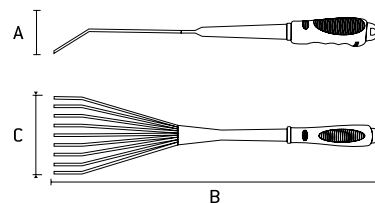

- Cabo de anatômico emborrachado | Rubberized anatomical handle | Mango de anatômico emborrachado
- Pode ser utilizado cabo extensor (630168 e 6030178) | Extender cable (630168 and 6030178) | Se puede utilizar el cable extensor (630168 y 6030178)
- Corpo metálico com pintura anticorrosão | Metal body with anti-corrosion paint | Cuerpo metálico con pintura anticorrosión

Mini - Pá de bico dobrável

Mini Shovel | Mini - Pala de pico

AUTO SERVIÇO



614288



1077g

DIMENSÕES | SIZE | TAMAÑO (MM)

A

B



12



Quant. Min.
0

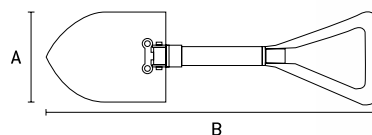

- Metálica | Metallic | Metálico
- Dobrável | Foldable | Plegable
- Sistema de fácil montagem e desmontagem | Easy assembly and disassembly system | Sistema de fácil montaje y desmontaje
- Embalagem protetora | Protective packaging | Embalaje protector

Balde

Bucket | Cubo

AUTO SERVIÇO



644958



625g

DIMENSÕES | SIZE | TAMAÑO (MM)

A



24



Quant. Min.
0*

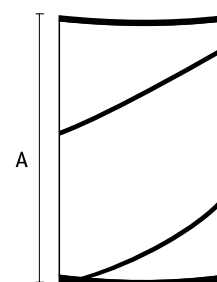

- 95 litros | 95 liters | 95 litros
- Cor: Verde | Green color | Color verde
- Flexível com alças | Flexible with handles | Flexible con tirantes

Bordas para jardim

Garden borders | Bordes para jardín



644808



480g

DIMENSÕES | SIZE | TAMAÑO (MM)

A

B



24



Quant. Min.
0*

644818

720g

10cm

9mt

24

0*

644828

809g

15cm

9mt

18

0*

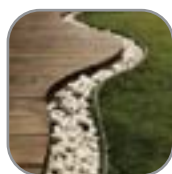

Aplicação
Application
Uso

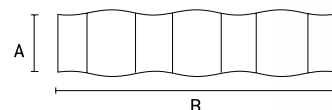

- Plástica | Plastic | Plástico
- Cor: Verde | Green color | Color verde

Esguicho Pistola

Squirt Gun | Eschicho Pistola

AUTO
SERVIÇO



651498



140g

DIMENSÕES | SIZE | TAMAÑO (MM)

A

B

C



Quant. Min.

48

0

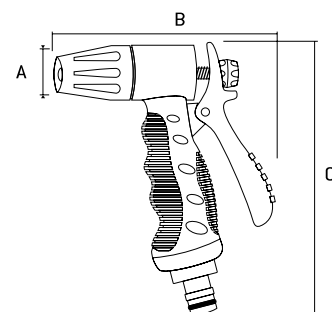

- Corpo plástico anatômico reforçado | Anatomically reinforced plastic body | Cuerpo plástico anatómico reforzado
- Jato regulável | Adjustable jet | Chorro regulable
- Embalagem: Blister | Packing: Blister | Embalaje: Blister

Esguicho Pistola

Squirt Gun | Eschicho Pistola

AUTO
SERVIÇO



651618



113g

DIMENSÕES | SIZE | TAMAÑO (MM)

A

B

C



Quant. Min.

80

0

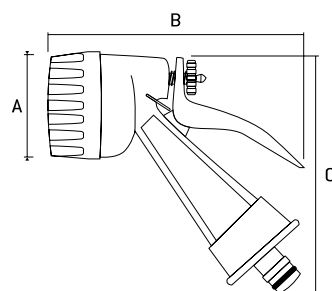

- Jato múltiplos com 7 posições de ajuste | Multiple jet with 7 setting positions | Chorro múltiplos con 7 posiciones de ajuste
- Estrutura em plástico ABS de alta resistência | High resistance ABS plastic frame | Estructura de plástico ABS de alta resistencia
- Embalagem: Blister | Packing: Blister | Embalaje: Blister

Jogo de conexão para mangueira

Set of connections for hose | Juego de conexiones para la manguera

AUTO
SERVIÇO



651768



194g



Quant. Min.

1/2"

72

0

651798

3/4"

111g

72

0

- Estrutura em plástico ABS de alta resistência | High resistance ABS plastic frame | Estructura de plástico ABS de alta resistencia
- Permite conexões rápidas | Allows quick connections | Permite conexiones rápidas
- Equipado com bico ajustável | Equipped with adjustable nozzle | Equipado con pico ajustable
- Oferece três modos de irrigação | It offers three modes of irrigation | Ofrece tres modos de riego
- Composição: 1 Esguicho, 1 conector de torneira e 2 engates rápidos (1 com passagem livre e 1 com bloqueador de passagem) | 1 nozzle, 1 tap connector and 2 quick couplings (1 with free passage and 1 with aquastop) | 1 Eslabón, 1 conector de grifo y 2 enganches rápidos (1 con paso libre y 1 con bloqueador de paso)
- Embalagem: Blister | Packing: Blister | Embalaje: Blister

Válvula pulverizadora
 Spray Valve | Válvula pulverizadora



			DIMENSÕES SIZE TAMAÑO (MM)			
647328	para garrafa	31g	A	B	200	0

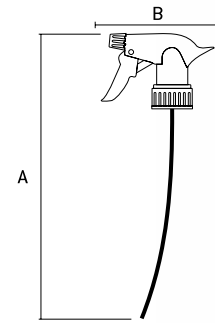

- Não utilizar produtos químicos como solventes ou ácidos | Do not use chemicals such as solvents or acids | No utilizar productos químicos como disolventes o ácidos
- Jato regulável | Adjustable jet | Chorro regulable

Conector triplo para engate rápido

Triple connector for quick coupling | Conector triple para acoplamiento rápido

AUTO SERVIÇO



			DIMENSÕES SIZE TAMAÑO (MM)			
657208	3/4" para 1/2"	17g	A	B	310	0
657258	3/4"	15g	110	70	320	0
657358	1" para 3/4" e 1/2" rosca interna	29g	70	110	300	0



• 657208

• 657258

• 657358

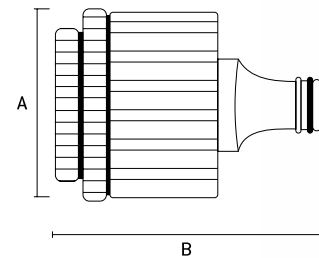
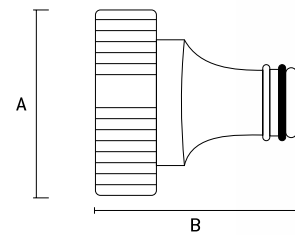
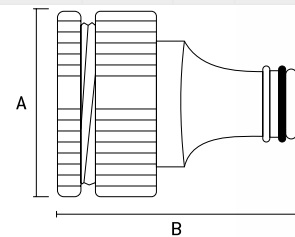

- Estrutura em plástico ABS de alta resistência | High resistance ABS plastic frame | Estructura de plástico ABS de alta resistencia
- Adaptador Fêmea | Female Adapter | Adaptador Hembra |
- Para colocação em torneiras de jardim para utilização com engate rápido | For placement on garden taps for use with quick coupling | Para colocación en grifos de jardín para uso con enganche rápido
- Embalagem: Blister | Packing: Blister | Embalaje: Blister

Adaptador de 3/4" com rosca externa

Adapter | Adaptador



		DIMENSÕES SIZE TAMAÑO (MM)			
657508	42g	A	B	250	0

AUTO SERVIÇO

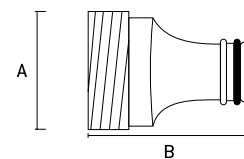

- Estrutura em plástico ABS | ABS plastic frame | Estructura de plástico ABS
- Embalagem: Blister | Packing: Blister | Embalaje: Blister



Engate rápido

Quick coupling | Enganche rápido



657558



42g

DIMENSÕES | SIZE | TAMAÑO (MM)

A

B



250



0

AUTO SERVIÇO



- 3/4" com bloqueador de passagem e conector macho 3/4", rosca externa | 3/4" with locking mechanism and 3/4" male connector, external thread | 3/4" con bloqueador de paso y conector macho 3/4", rosca externa

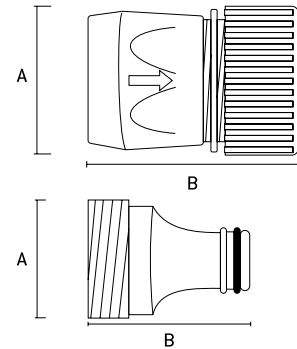

- Estrutura em plástico ABS | ABS plastic frame | Estructura de plástico ABS
- Para conexões de mangueiras de jardim | For garden hose connections | Para conexiones de mangueras de jardín
- Embalagem: Blister | Packing: Blister | Embalaje: Blister

Conector fêmea de plástico com bucha 3/4"

Plastic female connector with bushing | Conector hembra de plástico con casquillo



657608



3/4"



75g

DIMENSÕES | SIZE | TAMAÑO (MM)

A

B



80



0

AUTO SERVIÇO

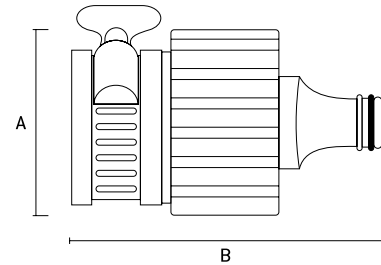

- Estrutura em plástico ABS | ABS plastic frame | Estructura de plástico ABS
- Para conexões de mangueiras de jardim | For garden hose connections | Para conexiones de mangueras de jardín
- Embalagem: Blister | Packing: Blister | Embalaje: Blister

Conector de mangueira 1/2"

Hose connector | Conector de manguera



661458



1/2"



20g

DIMENSÕES | SIZE | TAMAÑO (MM)

A

B



288



0

AUTO SERVIÇO

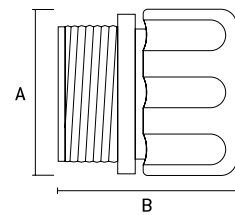

- Estrutura em plástico ABS | ABS plastic frame | Estructura de plástico ABS
- Para conexões de mangueiras de jardim | For garden hose connections | Para conexiones de mangueras de jardín
- Com rosca externa para adaptação com irrigadores | With external thread for adaptation with irrigators | Con rosca externa para adaptación con irrigadores
- Embalagem: Blister | Packing: Blister | Embalaje: Blister

Esguicho Ajustável

Adjustable Spray | Eschicho ajustable



651828



42g

DIMENSÕES | SIZE | TAMAÑO (MM)

A

B



288



0

AUTO SERVIÇO

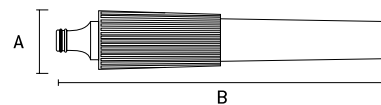

- Estrutura em plástico ABS de alta resistência | High resistance ABS plastic frame | Estructura de plástico ABS de alta resistencia
- Equipado com bico ajustável | Equipped with adjustable nozzle | Equipado con pico ajustable
- Oferece três modos de irrigação | It offers three modes of irrigation | Ofrece tres modos de riego
- Embalagem: Blister | Packing: Blister | Embalaje: Blister

Conectores e adaptadores com engate rápido

Connectors & Adapters | Conectores y adaptadores



• 661358

• 661608

- Estrutura em plástico ABS | ABS plastic frame | Estructura de plástico ABS
- Para conexões de mangueiras de jardim | For garden hose connections | Para conexiones de mangueras de jardín
- Passagem livre de água | Water free passage | Pasaje libre de agua
- Embalagem: Blister | Packing: Blister | Embalaje: Blister

Barcode	Size	Weight (KG)	DIMENSÕES SIZE TAMAÑO (MM)		Box Qty	Min. Qty
			A	B		
661358	1/2"	25g	70	110	300	0
661608	3/4"	33g	70	110	288	0

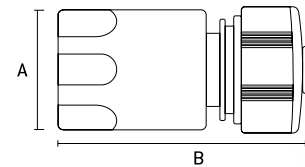
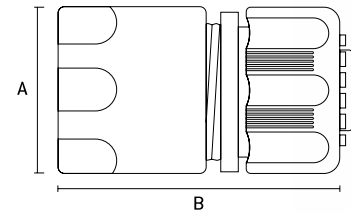

Conectores e adaptadores com engate rápido.

Connectors & Adapters | Conectores y adaptadores



• 661408

• 661658

- Estrutura em plástico ABS | ABS plastic frame | Estructura de plástico ABS
- Para conexões de mangueiras de jardim | For garden hose connections | Para conexiones de mangueras de jardín
- Com bloqueador de passagem de água | With water pass-through blocker | Con bloqueador de paso de agua
- Embalagem: Blister | Packing: Blister | Embalaje: Blister

Barcode	Weight (KG)	DIMENSÕES SIZE TAMAÑO (MM)		Box Qty	Min. Qty
		A	B		
661408	30g	70	110	300	0
661658	20g	70	110	288	0

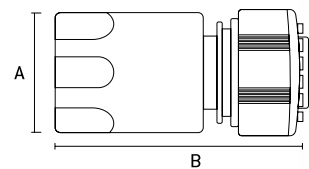
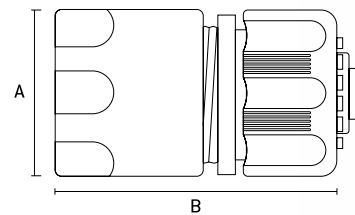

Emenda de mangueira

Hose attachment | Enmienda de manguera



• 664358

• 664418

- Estrutura em plástico ABS | ABS plastic frame | Estructura de plástico ABS
- Para conexões de mangueiras de jardim | For garden hose connections | Para conexiones de mangueras de jardín
- Passagem livre de água | Water free passage | Pasaje libre de agua
- Embalagem: Blister | Packing: Blister | Embalaje: Blister



Barcode	Size	Weight (KG)	DIMENSÕES SIZE TAMAÑO (MM)		Box Qty	Min. Qty
			A	B		
664358	1/2"	19g	70	115	288	0
664418	3/4"	32g	70	115	300	0

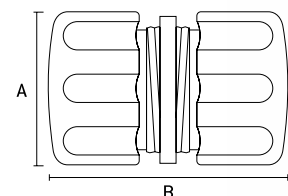
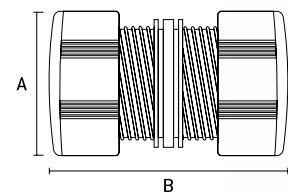

Conector macho

Connector male | Conector macho



661808



13g

DIMENSÕES | SIZE | TAMAÑO (MM)

A

B



500



0

AUTO SERVIÇO

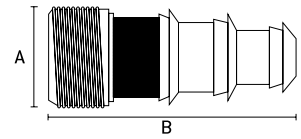

- Corpo plástico | Plastic body | Cuerpo plástico
- Com conexões para mangueira de jardim de 1/2" e 3/4" | With 1/2 "and 3/4" garden hose connections | Con conexiones para manguera de jardín de 1/2 "y 3/4"
- Rosca externa | External thread | Rosca externa
- Embalagem: Blister | Packing: Blister | Embalaje: Blister

Conector duplo para engate rápido

Double connector for quick coupling | Conector doble para enganche rápido



664658



1/2"



11g

DIMENSÕES | SIZE | TAMAÑO (MM)

A

B



500



0

AUTO SERVIÇO

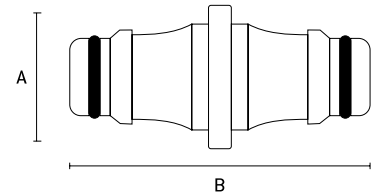

- Corpo plástico ABS | ABS Plastic body | Cuerpo plástico ABS
- Para união de 2 mangueiras de jardim com engate rápido 1/2" | For connection of 2 garden hoses with quick coupling 1/2 " | Para unión de 2 mangueras de jardín con acoplamiento rápido 1/2 "
- Embalagem: Blister | Packing: Blister | Embalaje: Blister

Conector triplo para engate rápido

Triple connector for quick coupling | Conector triple para enganche rápido



664688



1/2"



22g

DIMENSÕES | SIZE | TAMAÑO (MM)

A

B



350



0

AUTO SERVIÇO

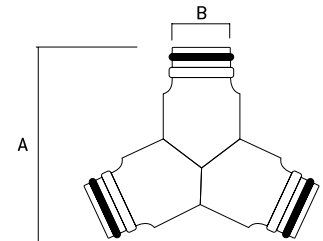

- Corpo plástico ABS | ABS Plastic body | Cuerpo plástico ABS
- Para união de 3 mangueiras de jardim com engate rápido 1/2" | For connection of 3 garden hoses with quick coupling 1/2 " | Para unión de 3 mangueras de jardín con acoplamiento rápido 1/2 "
- Embalagem: Blister | Packing: Blister | Embalaje: Blister

Ligação para 2 saídas ajustáveis

Connection for 2 adjustable outputs | Conexión para 2 salidas ajustables



664268



3/4"



60g

DIMENSÕES | SIZE | TAMAÑO (MM)

A

B



250



0

AUTO SERVIÇO

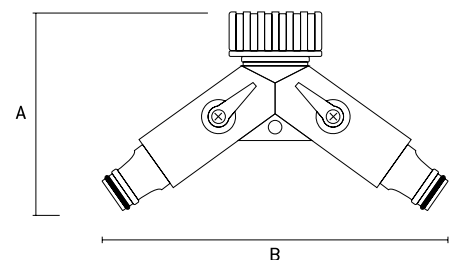

- Corpo plástico ABS | ABS Plastic body | Cuerpo plástico ABS
- Para conexões de mangueira de jardim | For garden hose connections | Para conexiones de manguera de jardín
- Embalagem: Blister | Packing: Blister | Embalaje: Blister

Irrigador rotativo de plástico

Plastic Rotary Irrigator | Irrigador giratorio de plástico



			DIMENSÕES SIZE TAMAÑO (MM)				
654098	3 jatos	185g	A	B	C	50	0

AUTO SERVIÇO

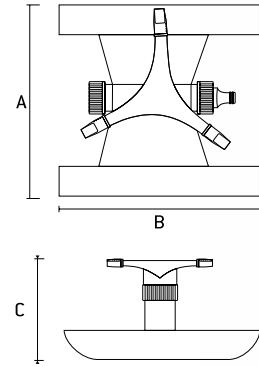

- Estrutura em plástico ABS | ABS plastic frame | Estructura de plástico ABS
- Cabeça móvel giratória | Moving head rotating | Cabeza móvil giratoria
- Gira sob pressão da água | Spin under water pressure | Gira bajo presión del agua
- Alcance reto de 15m | Straight reach of 15m | Alcance recto de 15m
- Alcança uma área de 180m² | It reaches an area of 180m² | Alcance un área de 180m²

Irrigador Múltiplo

Multiple Irrigator | Irrigador Múltiple



			DIMENSÕES SIZE TAMAÑO (MM)				
654638	6 jatos de modelos diferentes	227g	A	B	C	50	10

AUTO SERVIÇO

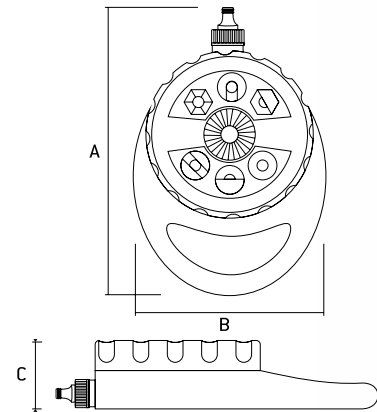

- Estrutura em plástico ABS | ABS plastic frame | Estructura de plástico ABS
- Fornece 8 modos de irrigação | Provides 8 modes of irrigation | Proporciona 8 modos de riego
- Faixa de pulverização de até 12m | Spray range up to 12m | Rango de pulverización de hasta 12m
- Alcança uma área de 113m² | It reaches an area of 113m² | Alcanza un área de 113m²

Irrigador setorial - tipo espiga

Sectorial irrigator - spike type | Irrigador sectorial - tipo espiga



		DIMENSÕES SIZE TAMAÑO (MM)				
654158	88g	A	B	48	0	0

AUTO SERVIÇO

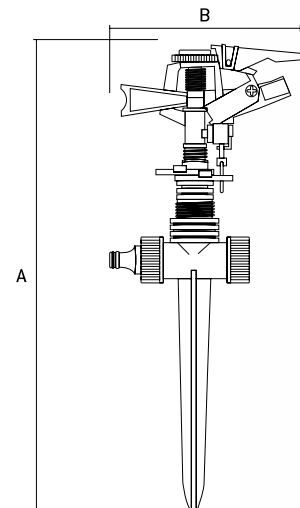

- Mecanismo de ajuste angular | Angular Adjustment Mechanism | Mecanismo de ajuste angular
- Pulverização a partir de 30° a 360° | Spraying from 30° to 360° | Pulverización a partir de 30° a 360°
- O raio do spray de até 12m | Spray radius up to 12m | El rayo del aerosol de hasta 12m
- Alcança uma área de 450m² | It reaches an area of 450m² | Alcanza un área de 450m²
- Embalagem: Blister | Packing: Blister | Embalaje: Blister



Kit de reparo para pulverizadores

Spray Repair Kit | Kit de reparación para pulverizadores



6474055	para 5 e 7 litros	50	0
6478555	para 20 litros	40	0

AUTO
SERVIÇO



- Jogo de acessórios para produtos 647408, 647508 e 647858 | Accessory kit for products 647408, 647508 and 647858 | Juego de accesorios para productos 647408, 647508 y 647858
- Borrachas | Rubber | Cauchos
- Mangueiras | Hoses | Mangueras
- Bicos de pulverização | Spray Nozzles | Boquillas de pulverización

Pulverizadores agrícolas

Agricultural Sprayers | Pulverizadores agrícolas



		KG	DIMENSÕES SIZE TAMAÑO (MM)			Quant. Min.
			A	B		
647358	1,25 litros	113g	270	90	40	1
647388	2 litros	395g	380	130	15	1
647408	5 litros	1133g	407	183	6	1
647508	7 litros	1320g	470	180	6	1
647858	20 litros	3550g	180	350	1	1

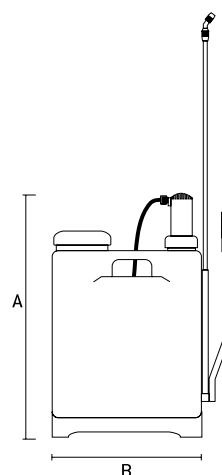
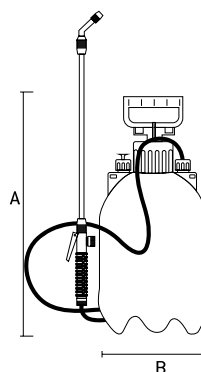
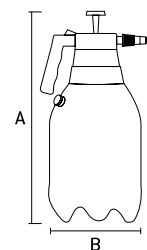
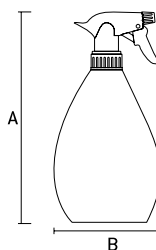

- Compressão prévia | Previous compression | Compresión previa
- Não utilizar produtos químicos como solventes ou ácidos | Do not use chemicals such as solvents or acids | No utilizar productos químicos como disolventes o ácidos
- Possui haste para pressurização | Has pressurizing rod | Posee vástago para presurización
- Válvula de segurança para avaliar pressão do reservatório | Safety valve to assess reservoir pressure | Válvula de seguridad para evaluar la presión del depósito
- Bico com jato regulável | Nozzle with adjustable jet | Boquilla con chorro regulable
- Alça regulável para transporte | Adjustable strap for transport | Alza regulable para el transporte

Luvas para Jardim

Garden gloves | Guantes de jardín



677428	TAMANHO SIZE M	47g	DIMENSÕES SIZE TAMANO (MM)			6	Quant. Min.
			A	B			
677438	TAMANHO SIZE L	39g	70	250	120	0	0
			15	260	120	0	0

AUTO SERVIÇO

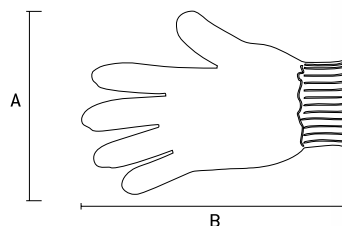

- Em poliéster nitrílico | In nitrilic polyester | En poliéster nitrílico
- Cor verde | Green color | Color verde
- Embalagem: Blister | Packing: Blister | Embalaje: Blister

Luvas para Jardim

Garden gloves | Guantes de jardín



677628	TAMANHO SIZE M	51g	DIMENSÕES SIZE TAMANO (MM)			6	Quant. Min.
			A	B			
677638	TAMANHO SIZE L	58g	70	270	300	0	0
			70	260	300	0	0

AUTO SERVIÇO

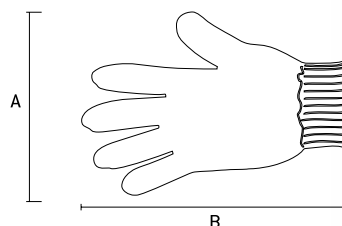

- Tricotada | Knitted | Tejido de punto
- Pigmentação em PVC | Pigmentation in PVC | Pigmentación en PVC
- Embalagem: Blister | Packing: Blister | Embalaje: Blister



Mesas dobráveis de alumínio com tampo de MDF

Aluminum folding tables with MDF tops | Mesas plegables de aluminio con tableros de MDF



695828	DIMENSÕES SIZE TAMANO (MM)				6	Quant. Min.
	A1	A2	B	C		
695838	250	590	600	450	6	0
	300	700	900	600	6	0

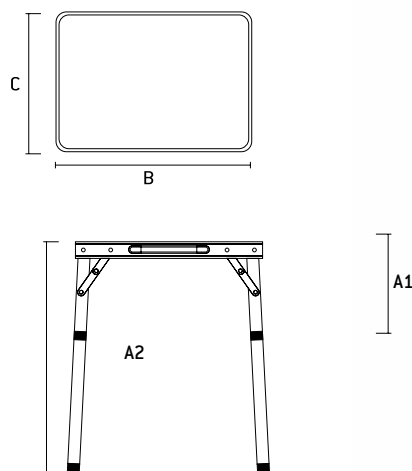

Kit Churrasco

Barbecue kit | Kit Barbacoa



			DIMENSÕES SIZE TAMAÑO (MM)				
7914955	7 peças	633g	A	B	C	50	1

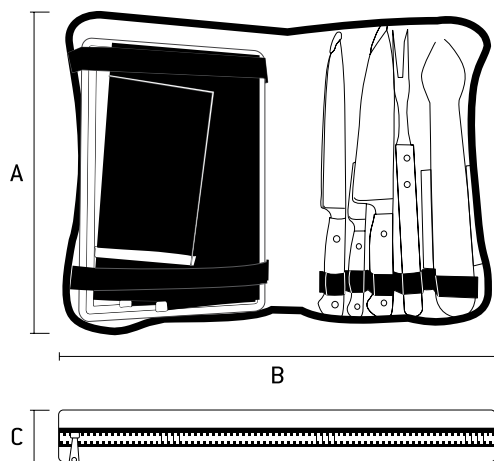

- 1 faca para carne Chef 9" | 1 Knife for Meat Chef 9" | 1 Cuchillo para carne Chef 9"
- 1 faca para carne Chef 8" | 1 Knife for Meat Chef 8" | 1 Cuchillo para carne Chef 8"
- 1 faca para legumes 4" | 1 knife for vegetables 4" | 1 Cuchillo para verduras 4"
- 1 pegador de carne | 1 meat picker | 1 pegador de carne
- 1 garfo trinchante | 1 Shredding fork | 1 horquilla trinchante
- 1 avental | 1 Apron | 1 Delantal
- 1 tábua de madeira (30x20x1,5cm) | 1 Wooden board (30x20x1,5cm) | 1 Tabla de madera (30x20x1,5cm)



CORTE

CUT | CORTE

FERRAMENTAS DE CORTE

CUT'S TOOLS
HERRAMIENTAS DE CORTE

As ferramentas de corte MTX e SPARTA proporcionam ao profissional ou consumidor final um produto de extrema eficiência para o trabalho a ser desenvolvido. Utilizando matérias primas de qualidade as ferramentas tem um ótimo desempenho e proporcionam um excelente resultado.

The cutting tools MTX and SPARTA provide the professional or final consumer with a product of extreme efficiency for the work to be developed. Using quality raw materials the tools have a great performance and provide an excellent result.

Las herramientas de corte MTX y SPARTA proporcionan al profesional o consumidor final un producto de extrema eficiencia para el trabajo a ser desarrollado. Utilizando materias primas de calidad las herramientas tienen un óptimo desempeño y proporcionan un excelente resultado.

SIMBOLOGIA



CÓDIGO
CODE



CARACTERÍSTICAS
Technical Features



PESO DA PEÇA
Part Weight
Peso de la Pieza



CAIXA MASTER
Box Master | Caja Máster



Quant. Mín.
Quant. Minimum
Cantidad Mínimo



Jogo de brocas de 3 pontas para madeira

Set of 3-prong drill bits for wood | Juego de brocas de 3 puntas para madera



• Composição | Composition | Composición
3,014,015,016,017,018,019,0110,0mm

	DIMENSÕES SIZE TAMAÑO (MM)	DIMENSÕES SIZE TAMAÑO (MM)		Quant. Min.	
		A	B		
7021255	3 mm (1/8")	3	60	100	25
	4 mm (5/32")	4	75		
	5 mm (3/16")	5	85		
	6 mm (1/4")	6	92		
	7 mm (9/32")	7	102		
	8 mm (5/16")	8	110		
	9 mm (3/8")	9	115		
	10 mm (13/32")	10	122		



- Indicada para madeira e derivados | Suitable for wood and derivatives | Indicada para madera y derivados
- Possui ponta com afiação que facilita a centralização do furo | It has a sharpening point that facilitates the centering of the hole | Posee punta con afilado que facilita la centralización del agujero
- Aço especial | Special steel | Acero especial

Jogo de brocas longa para madeira

Set of long drills for wood | Juego de fresas largas para madera



• Composição | Composition | Composición
6,018,0110,0112,0113,0114,0mm

	DIMENSÕES SIZE TAMAÑO (MM)	DIMENSÕES SIZE TAMAÑO (MM)		Quant. Min.	
		A	B		
7023055	6 mm (1/4")	6	300	20	0
	8 mm (5/16")	8	300		
	10 mm (13/32")	10	300		
	12 mm (15/32")	12	300		
	13 mm (1/2")	13	300		
	14 mm (9/16")	14	300		



- Indicada para madeira e derivados | Suitable for wood and derivatives | Indicada para madera y derivados
- Possui ponta com afiação que facilita a centralização do furo | It has a sharpening point that facilitates the centering of the hole | Posee punta con afilado que facilita la centralización del agujero
- Aço especial e Haste cilíndrica | Special Steel and Cylindrical Rod | Acero especial y Vástago cilíndrico
- Embalagem: Plástica/autoserviço | Packing: Plastic / Self Service | Embalaje: Plástico / auto servicio

Broca espiral para madeira

Spiral drill for wood | Taladro espiral para madera



	DIMENSÕES SIZE TAMAÑO (MM)	DIMENSÕES SIZE TAMAÑO (MM)		Quant. Min.	
		A	B		
701029	12 mm (15/32")	12	230	100	50
701049	14 mm (9/16")	14	230	100	50
701069	16 mm (5/8")	16	230	100	50
701089	20 mm (25/32")	20	230	100	50
701109	25 mm (1")	25	230	50	25
701129	32 mm (1.1/4")	32	230	25	25
701209	12 mm (15/32")	12	460	50	25
701229	14 mm (9/16")	14	460	50	25
701249	16 mm (5/8")	16	460	50	25



- Indicada para madeira maciça e derivados | Suitable for solid wood and derivatives | Indicada para madera maciza y derivados
- Possui ponta com afiação que facilita a centralização do furo | It has a sharpening point that facilitates the centering of the hole | Posee punta con afilado que facilita la centralización del agujero
- Haste sextavada | Hexagon rod | Vástago hexagonal
- Acabamento fosfatizado no veio de corte | Phosphatized Finishing on Cutting Shaft | Acabado fosfatizado en el eje de corte
- Uso profissional | Professional use | Uso profesional
- Embalagem: Plástica/autoserviço | Packing: Plastic / Self Service | Embalaje: Plástico / auto servicio

Jogo de brocas chatas para madeira

Set of boring wood drills | Juego de brocas para madera



Código	DIMENSÕES SIZE TAMAÑO (MM)	Quant. Min.			
			A	B	
7040555	10 mm (13/32")	10	150	100	10
	12 mm (15/32")	12	150		
	16 mm (5/8")	16	150		
	18 mm (23/32")	18	150		
	20 mm (25/32")	20	150		
	25 mm (1")	25	150		

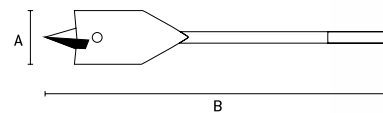

- Indicada para lâminas/chapas finas | Suitable for wood and derivatives | Indicada para madeira y derivados
- Possui ponta com afiação que facilita a centralização do furo | It has a sharpening point that facilitates the centering of the hole | Posee punta con afilado que facilita la centralización del agujero
- Haste polida e envernizada sextavada | Hexagonal polished and varnished rod | Vástago pulido y barnizado hexagonal
- Embalagem: Blister | Packing: Blister | Embalaje: Blister

Broca chata para madeira

Flat boring drill | Broca plana para madera



Código	DIMENSÕES SIZE TAMAÑO (MM)	Quant. Min.			
			A	B	
704009	6 mm (1/4")	6	150	300	75
704019	8 mm (5/16")	8	150	300	75
704049	10 mm (13/32")	10	150	300	75
704079	12 mm (15/32")	12	150	300	75
704099	14 mm (9/16")	14	150	300	75
704089	16 mm (5/8")	16	150	300	75
704109	18 mm (23/32")	18	150	300	75
704149	22 mm (7/8")	22	150	300	75
704159	24 mm (15/16")	24	150	300	75
704169	25 mm (1")	25	150	300	75
704249	32 mm (1.1/4")	32	150	240	70
704309	38 mm (1.1/2")	38	150	240	60
704339	45 mm (1.25/32")	45	150	240	60
704349	50 mm (2")	50	150	200	50

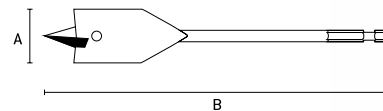

- Para madeira, MDF, MDP, compensado plástico | For wood, MDF, MDP, plastic plywood | Para madera, MDF, MDP, contrachapado plástico
- Indicada para lâminas/chapas finas | Suitable for wood and derivatives | Indicada para madeira y derivados
- Possui ponta com afiação que facilita a centralização do furo | It has a sharpening point that facilitates the centering of the hole | Posee punta con afilado que facilita la centralización del agujero
- Embalagem: Blister | Packing: Blister | Embalaje: Blister

Broca de Fresa para dobradiça

Flat boring drill | Broca plana para madera



Código	DIMENSÕES SIZE TAMAÑO (MM)		Quant. Min.	
	Ø	A		
704899	32	26	200	10
704909	35	26	200	10

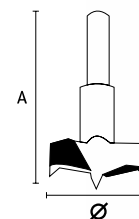

- Tipo Forstner | Type Forstner | Tipo Forstner
- Aço HSS | HSS steel | Acero HSS
- Para madeira compensada e madeira maciça | For plywood and solid wood | Para madera contrachapada y madera maciza
- Widea com parte de aço de alta dureza | Widea with steel part of high hardness | Widea con parte de acero de alta dureza
- Haste cilíndrica | Cylindrical Rod | Vástago cilíndrico

Jogo de fresa para madeira

Wood cutter set | Juego de fresa para madera



7044055	DIMENSÕES SIZE TAMAÑO (MM)		20	0
	A	B		
	10	87		
	15	87		
	20	87		
	25	87		
	35	87		



5 peças
parts | piezas

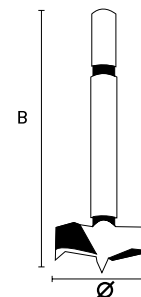

- Aço HSS | HSS steel | Acero HSS

Jogo de Lima rotativa

Rotating File Set | Juego de Lima rotativa



704999	200	25



5 peças
parts | piezas

- Para desbaste / acabamento | For roughing / finishing | Para desbaste / acabado
- Ponta Widea/metal duro | Wide / hard metal tip | Puntera Widea / metal duro
- Para madeira | For wood | Para madera

Broca bailarina

Drill for wood | Broca para madera



704979	155	210	60	6

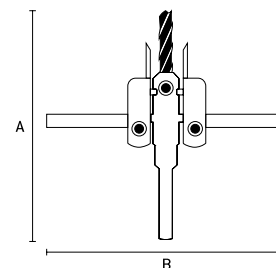
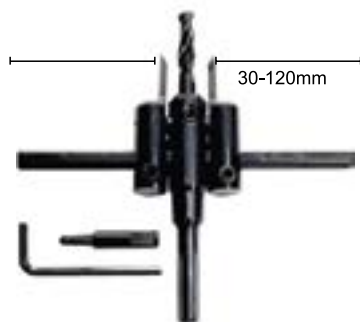

- Ajustável 30 - 120 mm Ø | Adjustable 30 - 120 mm Ø | Ajustable 30 - 120 mm Ø
- Excelente para fazer furos em madeira, gesso, plásticos, borrachas | Excellent for drilling holes in wood, plaster, plastics, rubbers | Excelente para hacer agujeros en madera, yeso, plásticos, gomas
- Corte de até 250 mm | Cutting up to 250 mm | Corte de hasta 250 mm
- Corte na profundidade de 25 mm

Jogo serra copo para madeira

Hole saw set for wood | Juego Sierra de agujero para madera



NOVO	DIMENSÕES SIZE TAMAÑO (MM)		Quant. Min.
	A	Ø	
7045055	25,4	26 - 63	0
7045255	50,8	26 - 63	0

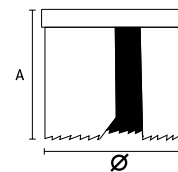

- Aço especial | Special steel | Acero especial
- Indicada para madeira, aglomerado e MDF | Suitable for wood, agglomerate and MDF | Indicada para madeira, aglomerado y MDF
- Possui suporte e broca guia | It has support and guide drill | Tiene soporte y broca guía
- Composição: 07 peças | Composition: 07 pieces | Composición: 07 piezas: Ø 26 - 32 - 38 - 44 - 50 - 56 - 63 mm
- Embalagem: caixa | Packing: Box | Embalaje: Caja

Jogo serra copo para madeira

Hole saw set for wood | Juego Sierra de agujero para madera



NOVO	DIMENSÕES SIZE TAMAÑO (MM)		Quant. Min.
	A	Ø	
7047159	25,4	64-127	0

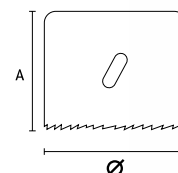

- Indicada para madeira, compensado, aglomerado e MDF | Suitable for wood, plywood, chipboard and MDF | Indicada para madeira, contrachapada, aglomerado y MDF
- 05 serras copo: cup saws: | sierras de vidrio: Ø 64, 76, 89, 102 e 127 mm
- 01 suporte para serra copo e broca | 01 bracket with hole | 01 soporte con agujero
- 01 broca com haste triangular | 01 drill with triangular rod | 01 broca con vástago triangular
- 01 chave allen | 01 allen key | 01 llave allen
- Embalagem: Caixa plástica | Packing: Plastic box | Embalaje: Caja plástica

Jogo serra copo para madeira

Hole saw set for wood | Juego Sierra de agujero para madera



NOVO	DIMENSÕES SIZE TAMAÑO (MM)		Quant. Min.
	A	Ø	
704729	25,4	19-127	0

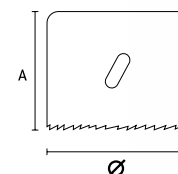

- Indicada para madeira, aglomerado e MDF | Suitable for wood, chipboard and MDF | Indicada para madeira, aglomerado y MDF
- 12 Serras Copo nas medidas: | 12 Saws Glass in measurements: | 12 Sierras Vaso en las medidas: Ø 19, 22, 29, 32, 38, 44, 51, 64, 76, 89, 102, 127 mm
- 01 suporte para serra copo de até 30 mm
- 01 broca com haste triangular para serras copo acima de 31 mm | 01 drill with triangular rod | 01 broca con vástago triangular
- 01 chave allen | 01 allen key | 01 llave allen
- Embalagem: Caixa plástica | Packing: Plastic box | Embalaje: Caja plástica

Jogo serra copo para madeira

Hole saw set for wood | Juego Sierra de agujero para madera



NOVO	DIMENSÕES SIZE TAMAÑO (MM)		Quant. Min.
	A	Ø	
704739	25,4	19-64	0

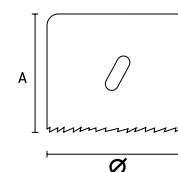

- Indicada para madeira, aglomerado e MDF | Suitable for wood, chipboard and MDF | Indicada para madeira, aglomerado y MDF
- 8 Serras copo: | 8 Cup Saws: | 8 Sierras de vaso: Ø 19, 22, 29, 32, 38, 44, 51 e 64mm
- 01 suporte com furo | 01 bracket with hole | 01 soporte con agujero
- 01 broca com haste triangular | 01 drill with triangular rod | 01 broca con vástago triangular
- 01 chave allen | 01 allen key | 01 llave allen
- Embalagem: Caixa plástica | Packing: Plastic box | Embalaje: Caja plástica

Broca bailarina para cerâmica

Drill for ceramics | Broca para cerâmica



7282155	DIMENSÕES SIZE TAMAÑO (MM)		60	15
	A	B		
	155	210		

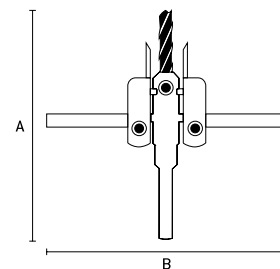

- Ajustável 30 - 120 mm Ø | Adjustable 30 - 120 mm Ø | Ajustable 30 - 120 mm Ø
- Excelente para fazer furos em azulejos e cerâmicas | Excellent for drilling holes in tiles and ceramics | Excelente para hacer agujeros en azulejos y cerâmicas
- Corte de até 260 mm | Cutting up to 260 mm | Corte de hasta 260 mm
- Corte na profundidade de 25 mm.

Jogo de broca para fechadura

Drill for wood | Broca para madeira



704919	704929	DIMENSÕES SIZE TAMAÑO (MM)		100	5
		A	B		
		22	48		
		22	55		

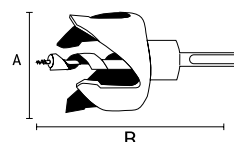

- Feito de aço carbono | Made of carbon steel | Hecho de acero al carbono
- Destina-se à instalação de fechaduras de porta | It is intended for the installation of door locks | Se destina a la instalación de cerraduras de puerta

Broca guia para serra copo - Wídea

Guide saw drill bit | Broca guia para Sierra de agujero



703389	Haste M22 x 250mm	DIMENSÕES SIZE TAMAÑO (MM)		30	0
		A	B		
		30	280		

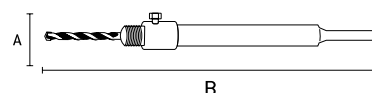

- Feito de aço carbono | Made of carbon steel | Hecho de acero al carbono
- Para utilização em conjunto com serra copo 703299 e 703319
- Encaixe SDS Plus

Serra copo - Wídea SDS Plus

Cup saw - Wídea | Sierra de agujero - Wídea



703299	703319	DIMENSÕES SIZE TAMAÑO (MM)		24	0
		A	B		
		m22x68	130		
		m22x80	130	20	

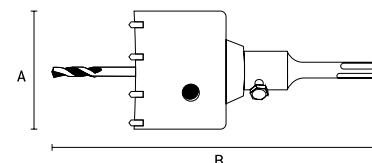

- Indicada para rompimento em alvenaria, fazer furos em paredes | Indicated for break in masonry, drill holes in walls | Indicada para rompimiento en albañilería, hacer agujeros en paredes
- Utilizada em martetele com encaixe SDS Plus | Used on a hammer with SDS Plus slot | Utilizada en martillo con encaje SDS Plus
- Haste com encaixe SDS Plus | SDS Plus Snap-On Rod | Vástago con ranura SDS Plus
- Embalagem: Caixa | Packing: Carton | Embalaje: Caja

Ponteiro SDS MAX

Pointer SDS MAX | Puntero SDS MAX



7034755	18 x 400mm	DIMENSÕES SIZE TAMAÑO (MM)		30	1
		A	B		



AUTO SERVIÇO



- Indicada para romper concreto, alvenaria e pedras | Indicated to break concrete, masonry and stones | Indicada para romper hormigón, albañilería y piedras
- Utilizada em martetele com encaixe SDS max | Used in hammer with SDS max | Utilizada en martillo con encaje SDS max
- Haste com encaixe SDS Max | SDS Max Docking Rod | Vástago con ranura SDS Max
- Proteção plástica total na broca | Full plastic protection on drill bit | Protección plástica total en la fresa
- Embalagem: Plástica para proteção completa da peça | Packaging: Plastic for complete protection of the part | Embalaje: Plástico para protección completa de la pieza

Ponteiro SDS PLUS

Pointer SDS PLUS | Puntero SDS PLUS



7034055	14x250mm	DIMENSÕES SIZE TAMAÑO (MM)		75	0
		A	B		



AUTO SERVIÇO



- Tipo SDS Plus | Type SDS Plus | Tipo SDS Plus
- Indicada para rompimento em alvenaria, fazer rasgos em paredes, remover pisos e azulejos | Indicated for break in masonry, make rips on walls, remove floors and tiles | Utilizada en martillo con encaje SDS max
- Utilizada em martetele com encaixe SDS Plus | Indicated for break in masonry, make rips on walls, remove floors and tiles... | Utilizada en martillo con encaje SDS max
- Haste com encaixe SDS Plus | SDS Plus Snap-On Rod | Vástago con ranura SDS Plus
- Proteção plástica total na broca | Full plastic protection on drill bit | Protección plástica total en la fresa
- Embalagem: Clip plástico | Packing: Plastic Clip | Packing: Plastic Clip

Talhadeira SDS MAX

Chisel SDS MAX | Cinzel SDS MAX



7034155	18x25x280mm	DIMENSÕES SIZE TAMAÑO (MM)		50	0
		A	B		
7034455	25x50x360mm	50	360	20	0



AUTO SERVIÇO



- Tipo SDS MAX | Type SDS MAX | Tipo SDS MAX
- Indicada para rompimento em alvenaria, fazer rasgos em paredes, remover pisos e azulejos | Indicated for break in masonry, make rips on walls, remove floors and tiles | Indicada para rompimiento en albañilería, hacer rasgos en paredes, quitar pisos y azulejos
- Utilizada em martetele com encaixe SDS MAX | Used on a hammer with SDS MAX slot | Utilizada en martillo con encaje SDS MAX
- Haste com encaixe SDS MAX | SDS MAX Snap-On Rod | Vástago con ranura SDS MAX
- Proteção plástica total na broca | Full plastic protection on drill bit | Protección plástica total en la fresa
- Embalagem: Clip plástico | Packing: Plastic Clip | Packing: Plastic Clip

Talhadeira SDS PLUS

Chisel SDS PLUS | Cinzel SDS PLUS



7031055	14x40x250mm	DIMENSÕES SIZE TAMAÑO (MM)		50	0
		A	B		
7032055	14x20x250mm	20	250	75	0



AUTO SERVIÇO



- Tipo SDS PLUS | Type SDS PLUS | Tipo SDS PLUS
- Indicada para rompimento em alvenaria, fazer rasgos em paredes, remover pisos e azulejos | Indicated for break in masonry, make rips on walls, remove floors and tiles | Indicada para rompimiento en albañilería, hacer rasgos en paredes, quitar pisos y azulejos
- Utilizada em martetele com encaixe SDS PLUS | Used on a hammer with SDS PLUS slot | Utilizada en martillo con encaje SDS PLUS
- Haste com encaixe SDS PLUS | SDS PLUS Snap-On Rod | Vástago con ranura SDS PLUS
- Proteção plástica total na broca | Full plastic protection on drill bit | Protección plástica total en la fresa
- Embalagem: Clip plástico | Packing: Plastic Clip | Packing: Plastic Clip



Adaptador para mandril SDS Plus

Adapter for mandrel | Adaptador para mandril



Código	Descrição	DIMENSÕES SIZE TAMAÑO (MM)		Quant. Máx.	Quant. Mín.
		A	B		
703569	Para mandril de 1/2"	24	94	500	0
703579	Rosca M12	26	95	500	0

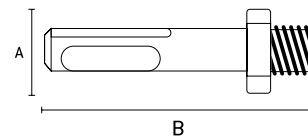

- Adaptador para encaixe SDS Plus | SDS Plus Dock Adapter | Adaptador para encaje SDS Plus

Broca de concreto SDS PLUS

Concrete drill bit SDS PLUS | Broca de concreto SDS PLUS



Ponta Em Cruz | Cross Tip | Punta En Cruz

Código	Dimensões	DIMENSÕES SIZE TAMAÑO (MM)		Quant. Máx.	Quant. Mín.
		A	B		
7062655	6 x 110 mm	6	110	240	120
7062855	8 x 110 mm	8	110	240	120
7063055	10 x 110 mm	10	110	240	120
7063655	6 x 160 mm	6	160	240	120
7063855	8 x 160 mm	8	160	240	120
7064055	10 x 160 mm	10	160	240	120
7064255	12 x 160 mm	12	160	240	120
7064655	6 x 210 mm	6	210	120	60
7064855	8 x 210 mm	8	210	120	20
7065055	10 x 210 mm	10	210	120	20
7065255	12 x 210 mm	12	210	120	20

- Utilizadas em martelletes com encaixe tipo SDS - PLUS | Used in SDS - PLUS type jig hammers | Utilizadas en martelletes con acoplamiento tipo SDS - PLUS
- Indicada para concreto, concreto armado (com vergalhão) | Indicated for concrete, reinforced concrete (with rebar) | Indicada para hormigón, hormigón armado (con varilla)
- Videia em cruz | Cross-over | Véase en cruz
- Embalagem: Clip plástico | Packing: Plastic Clip | Embalaje: Clip plástico



Broca para concreto - Golden Line

Concrete drill - Golden line | Taladro para hormigón - Golden Line



Código	Dimensões	DIMENSÕES SIZE TAMAÑO (MM)		Quant. Máx.	Quant. Mín.
		A	B		
708049	4 x 75 mm	4,0	75	500	250
708059	5 x 85 mm	5,0	85	500	250
708069	6 x 100 mm	6,0	100	500	250
708089	8 x 120 mm	8,0	120	200	100
708109	10 x 120 mm	10,0	120	200	100
708129	12 x 150 mm	12,0	150	200	100



- Ranhura especial que reduz o atrito e o aquecimento da broca | Special groove that reduces friction and heating of the drill bit | Ranura especial que reduce la fricción y el calentamiento de la broca
- Haste cilíndrica | Cylindrical Rod | Vástago cilíndrico
- Embalagem: Blister | Packing: Blister | Embalaje: Blister

Jogo de Broca para Concreto - Golden Line

Drill Set for Concrete - Golden line | Juego de Broca para Concreto - Golden Line



Código	Dimensões	DIMENSÕES SIZE TAMAÑO (MM)		Quant. Máx.	Quant. Mín.
		A	B		
708259	5 x 85 mm	5	85	100	50
	6 x 120 mm	6	120		
	8 x 120 mm	8	120		
	10 x 120 mm	10	120		



- Ranhura especial que reduz o atrito e o aquecimento da broca | Special groove that reduces friction and heating of the drill bit | Ranura especial que reduce la fricción y el calentamiento de la broca
- Haste cilíndrica | Cylindrical Rod | Vástago cilíndrico
- Embalagem: Blister | Packing: Blister | Embalaje: Blister

Broca para Concreto

Concrete drill | Broca para concreto



BLISTER



Código	Dimensões	DIMENSÕES SIZE TAMAÑO (MM)		Quant. Min.	
		A	B		
708549	4 x 75 mm	4,0	75	400	100
708559	5 x 85 mm	5,0	85	400	100
708569	6 x 100 mm	6,0	100	400	100
708589	8 x 120 mm	8,0	120	400	100
708609	10 x 120 mm	10,0	120	400	100
708629	12 x 150 mm	12,0	150	400	100



- Acabamento Polido | Polished Finish | Acabado Pulido
- Haste cilíndrica | Cylindrical Rod | Vástago cilíndrico
- Norma DIN 8039 | Standard DIN 8039 | Norma DIN 8039
- Sulco fosfatizado | Phosphatized furrow | Surco fosfatizado
- Têmpera total no corpo | Total body hardening | Têmpera total en el cuerpo
- Ponta de carboneto de tungstênio (metal duro) | Tungsten carbide tip (carbide) | Extremidad de carburo de tungsteno (metal duro)
- Embalagem: Blister | Packing: Blister | Embalaje: Blister

Broca para Concreto SDS PLUS

Concrete drill SDS PLUS | Broca para concreto SDS PLUS



AUTO SERVIÇO



Código	Dimensões	DIMENSÕES SIZE TAMAÑO (MM)		Quant. Min.	
		A	B		
7100155	4 x 110 mm	4,0	110	240	0
7100255	5 x 110 mm	5,0	110	240	0
7100355	6 x 110 mm	6,0	110	240	0
7100555	8 x 110 mm	8,0	110	240	0
7101655	6 x 160 mm	6,0	160	240	0
7101855	8 x 160 mm	8,0	160	240	0
7102255	10 x 160 mm	10	160	240	0
7102355	12 x 160 mm	12	160	240	0
7102455	14 x 160 mm	14	160	120	0
7102655	6 x 210 mm	6,0	210	120	0
7102755	8 x 210 mm	8,0	210	120	0
7102955	10 x 210 mm	10	210	120	0
7103155	12 x 210 mm	12	210	120	0
7103355	14 x 210 mm	14	210	120	0
7103855	8 x 300 mm	8,0	300	120	0
7103755	12 x 300 mm	12	300	120	0
7103955	14 x 300 mm	14	300	120	0
7104055	10 x 300 mm	10	300	120	0
7104155	16 x 300 mm	16	300	50	0
7104855	18 x 400 mm	18	400	50	0
7105055	20 x 400 mm	20	400	30	0
7105255	22 x 400 mm	22	400	30	0
7106455	14 x 600 mm	14	600	30	0
7091255	18 x 300 mm	18	300	60	0
7091455	20 x 300 mm	20	300	50	0
7091655	22 x 300 mm	22	300	30	0
7092255	26 x 300 mm	26	300	20	0
7094255	24 x 400 mm	24	400	20	0



- Encaixe SDS Plus | SDS Plus slot | Encaje SDS Plus
- Acabamento jateado | Blasting finish | Acabado Areñado
- Norma DIN 8039 | Standard DIN 8039 | Norma DIN 8039
- Proteção plástica total na broca | Full plastic protection on drill bit | Protección plástica total en la fresa
- Têmpera total no corpo | Total body hardening | Têmpera total en el cuerpo
- Ponta de carboneto de tungstênio (metal duro) | Tungsten carbide tip (carbide) | Extremidad de carburo de tungsteno (metal duro)
- Embalagem: Clip Plástico | Packing: Plastic Clip | Embalaje: Clip Plástico

Broca para Concreto SDS MAX

Concrete drill SDS MAX | Broca para concreto SDS MAX



AUTO SERVIÇO



Código	Dimensões	DIMENSÕES SIZE TAMAÑO (MM)			Quant. Min.	
		A	B	C		
7122355	12 x 340 mm	12	340	23	30	0
7122455	12 x 540 mm	12	540	23	20	0
7123655	14 x 340 mm	14	340	26	30	0
7123755	14 x 540 mm	14	540	26	20	0
7126155	30 x 370 mm	30	370	35	10	0
7126255	30 x 600 mm	30	600	35	10	0
7126655	16 x 340 mm	16	340	28	30	0
7126755	16 x 540 mm	16	540	28	20	0
7127155	18 x 340 mm	18	340	34	30	0
7127555	19 x 340 mm	19	340	34	30	0
7127655	19 x 540 mm	19	540	35	20	0
7128055	20 x 320 mm	20	320	25	30	0
7128155	20 x 520 mm	20	520	25	20	0
7128455	22 x 320 mm	22	320	22	30	0
7128555	22 x 520 mm	22	520	22	20	0
7128755	25 x 320 mm	25	320	27	20	0
7128855	25 x 520 mm	25	520	26	20	0
7129355	28 x 370 mm	28	370	32	20	0
7129455	28 x 570 mm	28	570	32	10	0
7129755	32 x 370 mm	32	370	35	20	0
7129855	32 x 570 mm	32	570	35	10	0



- Tipo de mandril de perfuração SDS MAX | Type of drill chuck SDS MAX | Tipo de mandril de perforación SDS MAX
- Tamanho da broca 16 mm | Drill size 16 mm | Tamaño de la broca 16 mm
- Comprimento da broca 400 mm | Drill length 400 mm | Longitud de la broca 400 mm

Broca HSS Professional Cobalto

HSS Professional Drill | Broca HSS Professional



BLISTER



Código	Descrição	DIMENSÕES SIZE TAMAÑO (MM)		Quant. Máx.	Quant. Mín.
		A	B		
714029	2,0 mm - 2 pçs	2,0	80	500	125
714069	2,5 mm - 2 pçs	2,5	70	500	125
714119	3,0 mm - 2 pçs	3,0	75	500	125
714179	3,5 mm - 2 pçs	3,5	90	500	125
714199	4,0 mm - 1 pç	4,0	85	500	125
714229	4,5 mm - 1 pç	4,5	110	480	120
714269	5,0 mm - 1 pç	5,0	110	480	120
714299	5,5 mm - 1 pç	5,5	110	480	120
714369	6,0 mm - 1 pç	6,0	110	480	120
714399	6,5 mm - 1 pç	6,5	115	480	120
714479	7,0 mm - 1 pç	7,0	140	300	75
714539	7,5 mm - 1 pç	7,5	140	300	75
714589	8,0 mm - 1 pç	8,0	140	300	75
714699	9,0 mm - 1 pç	9,0	140	300	75
714729	10,0 mm - 1 pç	10,0	155	200	50
714829	12,0 mm - 1 pç	12,0	165	200	50



- Para corte de aço inox, aço temperado, ferro e latão | For cutting of stainless steel, tempered steel, iron and brass | Para corte de acero inoxidable, acero templado, hierro y latón
- Haste cilíndrica | Cylindrical Rod | Vástago cilíndrico
- Ângulo de afiação da ponta de 118° | 118° tip sharpening angle | Ángulo de afinación de la punta de 118°
- Norma DIN 338 | Standard DIN 338 | Norma DIN 338
- HSS com 5% de cobalto para aumentar a dureza e resistência ao calor do produto | HSS with 5% cobalt to increase the hardness and heat resistance of the product | HSS con un 5% de cobalto para aumentar la dureza y resistencia al calor del producto
- Adequada para uso industrial | Suitable for industrial use | Adecuada para uso industrial
- Embalagem: blister | Packing: blister | Embalaje: blister

Broca HSS Professional Aço Rápido

HSS Professional Drill | Broca HSS Professional



Código	Descrição	DIMENSÕES SIZE TAMAÑO (MM)		Quant. Máx.	Quant. Mín.
		A	B		
7156055	1/16" x 70 mm - 10 pçs	1/16"	70	400	10
7156155	5/64" x 70 mm - 10 pçs	5/64"	70	400	10
7156255	3/32" x 70 mm - 10 pçs	3/32"	70	400	10
7156355	7/64" x 70 mm - 10 pçs	7/64"	70	400	10
7156455	1/8" x 80 mm - 10 pçs	1/8"	80	400	10
7156555	9/64" x 85 mm - 10 pçs	9/64"	85	400	10
7156655	5/32" x 85 mm - 10 pçs	5/32"	85	400	10
7156755	11/64" x 110 mm - 10 pçs	11/64"	110	240	10
7156855	3/16" x 110 mm - 10 pçs	3/16"	110	240	10
7156955	13/64" x 110 mm - 10 pçs	13/64"	110	240	10
7157055	7/32" x 110 mm - 10 pçs	7/32"	110	240	10
7157155	1/4" x 120 mm - 10 pçs	1/4"	120	200	10
7157255	5/16" x 140 mm - 10 pçs	5/16"	140	120	5
7157455	3/8" x 160 mm - 10 pçs	3/8"	160	60	5
7157555	7/16" x 155 mm - 10 pçs	7/16"	155	60	5
7157655	1/2" x 155 mm - 10 pçs	1/2"	155	60	5



- Para metais ferrosos e não ferrosos | For ferrous and non-ferrous metals | Para metales ferrosos y no ferrosos
- Haste cilíndrica | Cylindrical Rod | Vástago cilíndrico
- Norma DIN 338 | Standard DIN 338 | Norma DIN 338
- Ângulo de afiação da ponta de 118° | 118° tip sharpening angle | Ángulo de afinación de la punta de 118°
- Para aumento da vida útil do produto é recomendado a utilização de fluido / óleo de corte para lubrificação e resfriamento | For increased product life it is recommended to use cutting fluid / oil for lubrication and cooling | Para el aumento de la vida útil del producto se recomienda el uso de fluidos / aceite de corte para la lubricación y el enfriamiento

Broca para Fibrocimento e Mourão



Código	Dimensões	DIMENSÕES SIZE TAMAÑO (MM)		Quant. Min.
		A	B	
7080155	1/4" x 250 MM	6	250	10
7080255	9/32" x 250 MM	7	250	10
7080355	5/16" x 280 MM	8	280	10
7080455	1/2" x 400 MM	13	400	5
7080555	9/16" x 440 MM	14	440	5
7080655	5/8" x 480 MM	16	480	5

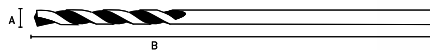

Broca HSS Standard

HSS Standard Drill | Broca HSS Estándar



HRC
62-65



Código	Dimensões	DIMENSÕES SIZE TAMAÑO (MM)		Quant. Min.	
		A	B		
715109	1,0 x 70 mm - 10 pçs	1,0	70	400	10
715159	1,5 x 70 mm - 10 pçs	1,5	70	400	10
715209	2,0 x 70 mm - 10 pçs	2,0	80	400	10
715259	2,5 x 70 mm - 10 pçs	2,5	70	400	10
715309	3,0 x 75 mm - 10 pçs	3,0	75	400	10
715359	3,5 x 90 mm - 10 pçs	3,5	90	400	10
715409	4,0 x 85 mm - 10 pçs	4,0	85	400	10
715459	4,5 x 110 mm - 10 pçs	4,5	110	240	10
715509	5,0 x 110 mm - 10 pçs	5,0	110	240	10
715559	5,5 x 110 mm - 10 pçs	5,5	110	240	10
715609	6,0 x 110 mm - 10 pçs	6,0	110	200	10
715659	6,5 x 115 mm - 10 pçs	6,5	115	200	10
715709	7,0 x 140 mm - 10 pçs	7,0	140	120	10
715759	7,5 x 140 mm - 10 pçs	7,5	140	120	10
715809	8,0 x 140 mm - 10 pçs	8,0	140	120	10
715859	8,5 x 140 mm - 10 pçs	8,5	140	60	5
715909	9,0 x 140 mm - 10 pçs	9,0	140	60	5
715959	9,5 x 155 mm - 10 pçs	9,5	155	60	5
715999	10 x 155 mm - 10 pçs	10,0	155	60	5
720109	11 x 170 mm - 5 pçs	11,0	170	60	5
720209	12 x 165 mm - 5 pçs	12,0	165	60	5
720309	13 x 170 mm - 5 pçs	13,0	170	60	5
720409	14 x 170 mm - 5 pçs	14,0	170	20	0
720509	15 x 200 mm - 5 pçs	15,0	200	20	0
720609	16 x 200 mm - 5 pçs	16,0	200	20	0
720709	17 x 220 mm - 5 pçs	17,0	220	20	0
720809	18 x 220 mm - 5 pçs	18,0	220	20	0
720909	19 x 210 mm - 5 pçs	19,0	210	20	0
720999	20 x 220 mm - 5 pçs	20,0	220	20	0

- Polida | Polished | Pulido
- Para metais ferrosos e não ferrosos | For ferrous and non-ferrous metals | Para metales ferrosos y no ferrosos
- Haste cilíndrica | Cylindrical Rod | Vástago cilíndrico
- Ângulo de afiação da ponta de 118° | 118° tip sharpening angle | Ángulo de afinación de la punta de 118°
- Norma DIN 338 | Standard DIN 338 | Norma DIN 338
- Para aumento da vida útil do produto é recomendado a utilização de fluido / óleo de corte para lubrificação e resfriamento | For increased product life it is recommended to use cutting fluid / oil for lubrication and cooling | Para el aumento de la vida útil del producto se recomienda el uso de fluidos / aceite de corte para la lubricación y el enfriamiento

Broca HSS Profissional Nitreto de Titânio

HSS Professional Drill | Broca HSS Professional



HSS

BLISTER



Código	Dimensões	DIMENSÕES SIZE TAMAÑO (MM)		Quant. Min.	
		A	B		
7172029	2,0 mm - 1 pç	2,0	80	600	150
7172529	2,5 mm - 1 pç	2,5	80	600	150
7173029	3,0 mm - 1 pç	3,0	80	600	150
7173529	3,5 mm - 1 pç	3,5	80	600	150
7174029	4,0 mm - 1 pç	4,0	80	600	150
7174529	4,5 mm - 1 pç	4,5	80	600	150
7175029	5,0 mm - 1 pç	5,0	80	400	100
7175529	5,5 mm - 1 pç	5,5	80	400	100
7176029	6,0 mm - 1 pç	6,0	80	400	100
7176529	6,5 mm - 1 pç	6,5	80	400	100
7177029	7,0 mm - 1 pç	7,0	80	400	100
7177529	7,5 mm - 1 pç	7,5	80	400	100
7178029	8,0 mm - 1 pç	8,0	80	400	100
7178529	8,5 mm - 1 pç	8,5	180	400	100
7179029	9,0 mm - 1 pç	9,0	225	200	50
7179529	10,0 mm - 1 pç	10,0	225	200	50

- Polida/Nitreto de Titânio | Polished / Titanium Nitride | Polida / Nitruro de Titânio
- Para metais ferrosos e não ferrosos | For ferrous and non-ferrous metals | Para metales ferrosos y no ferrosos
- Ângulo de afiação da ponta de 118° | 118° tip sharpening angle | Ángulo de afinación de la punta de 118°
- Norma DIN 338 | Standard DIN 338 | Norma DIN 338
- Corpo de aço rápido (HSS) | Quick Steel Body (HSS) | Cuerpo de acero rápido (HSS)
- Revestida com nitreto de titânio para duplicar a vida útil do produto e qualidade de corte | Coated with titanium nitride to double product life and cut quality | Revestida con nitruro de titânio para duplicar la vida útil del producto y la calidad de corte
- Encaixe Sextavado | Fitting Sixth | Encaje Sextavado
- Embalagem: blister | Packing: blister | Embalaje: blister



Broca HSS Profissional Nitreto de Titânio

HSS Professional Drill | Broca HSS Professional



BLISTER



Código	Descrição	DIMENSÕES SIZE TAMAÑO (MM)			Quant. Min.
		A	B		
7172009	2,0 mm - 1 pç	2,0	49	600	150
7172509	2,5 mm - 1 pç	2,5	57	600	150
7173009	3,0 mm - 1 pç	3,0	61	600	150
7173509	3,5 mm - 1 pç	3,5	70	600	150
7174009	4,0 mm - 1 pç	4,0	75	600	150
7174509	4,5 mm - 1 pç	4,5	80	600	150
7175009	5,0 mm - 1 pç	5,0	86	600	150
7175509	5,5 mm - 1 pç	5,5	93	600	150
7176009	6,0 mm - 1 pç	6,0	80	600	150
7176509	6,5 mm - 1 pç	6,5	80	600	150
7177009	7,0 mm - 1 pç	7,0	80	400	100
7177509	7,5 mm - 1 pç	7,5	80	400	100
7178009	8,0 mm - 1 pç	8,0	80	400	100
7179009	9,0 mm - 1 pç	9,0	225	200	50
7179509	10,0 mm - 1 pç	10,0	225	200	50
7179809	12,0 mm - 1 pç	12,0	225	200	50



- Polida/Nitreto de Titânio | Polished / Titanium Nitride | Polida / Nitruro de Titanio
- Para metais ferrosos e não ferrosos | For ferrous and non-ferrous metals | Para metales ferrosos y no ferrosos
- Haste cilíndrica | Cylindrical Rod | Vástago cilíndrico
- Ângulo de afiação da ponta de 118° | 118° tip sharpening angle | Ángulo de afinación de la punta de 118°
- Norma DIN 338 | Standard DIN 338 | Norma DIN 338
- Corpo de aço rápido (HSS) | Quick Steel Body (HSS) | Cuerpo de acero rápido (HSS)
- Revestida com nitreto de titânio para duplicar a vida útil do produto e qualidade de corte | Coated with titanium nitride to double product life and cut quality | Revestida con nitruro de titanio para duplicar la vida útil del producto y la calidad de corte
- Embalagem: blister | Packing: blister | Embalaje: blister

Broca HSS Profissional Industrial

HSS Professional Drill | Broca HSS Professional



Código	Descrição	DIMENSÕES SIZE TAMAÑO (MM)			Quant. Min.	
		A	B	C		
7180055	1,0 X 40 mm - 2 pçs	51	180	6	500	50
7180155	1,5 x 40 mm - 2 pçs	51	180	6	500	50
7180355	2,0 x 49 mm - 2 pçs	51	180	7	500	50
7180455	2,5 x 57 mm - 2 pçs	51	180	7	500	50
7180655	3,0 x 60 mm - 2 pçs	50	225	10	500	50
7180855	3,5 x 70 mm - 2 pçs	51	180	7	500	50
7181055	4,0 x 75 mm - 1 pç	50	180	6	500	50
7181255	4,5 x 80 mm - 1 pç	51	180	7	480	48
7181455	5,0 x 86 mm - 1 pç	51	180	7	480	48
7181655	5,5 x 93 mm - 1 pç	51	180	7	480	48
7181855	6,0 x 93 mm - 1 pç	51	180	7	480	48
7181955	6,5 x 100 mm - 1 pç	51	180	8	480	48
7182255	7,0 x 109 mm - 1 pç	51	228	10	300	30
7182355	7,5 x 109 mm - 1 pç	50	225	9	300	30
7182655	8,0 x 117 mm - 1 pç	51	228	10	300	30
7182755	8,5 x 117 mm - 1 pç	51	228	10	300	30
7182855	9,0 x 125 mm - 1 pç	51	228	12	300	30
7182955	9,5 x 125 mm - 1 pç	51	228	12	200	20
7183055	10,0 x 133 mm - 1 pç	51	228	12	200	20
7183455	11,0 x 142 mm - 1 pç	51	228	14	200	20
7183655	12,0 x 151 mm - 1 pç	51	227	14	200	20
7183955	13,0 x 151 mm - 1 pç	51	228	17	200	20
7184155	14,0 x 160 mm - 1 pç	60	280	18	100	10
7184255	15,0 x 169 mm - 1 pç	60	280	18	100	10
7184355	16,0 x 178 mm - 1 pç	60	280	18	100	10
7184455	17,0 x 184 mm - 1 pç	60	280	22	100	10
7184555	18,0 x 191 mm - 1 pç	60	280	22	80	20
7184655	19,0 x 198 mm - 1 pç	60	280	22	80	20
7184755	20,0 x 205 mm - 1 pç	60	280	22	80	20
7186155	1/16" x 43 mm - 2 pçs	1	180	50	500	50
7186255	5/64" x 49 mm - 2 pçs	2	180	50	500	50
7186355	3/32" x 57 mm - 2 pçs	2	180	50	500	50
7186455	7/64" x 61 mm - 2 pçs	3	180	50	500	50
7186555	1/8" x 65 mm - 2 pçs	50	180	5	500	50
7186655	9/64" x 70 mm - 2 pç	50	180	5	500	50
7186755	5/32" x 75 mm - 1 pç	50	180	6	500	50
7186855	11/64" x 80 mm - 1 pç	4	180	60	480	48
7186955	3/16" x 86 mm - 1 pç	50	180	6	480	48
7187055	13/64" x 86 mm - 1 pç	5	180	60	480	48
7187155	7/32" x 93 mm - 1 pç	50	180	6	480	48
7187255	1/4" x 101 mm - 1 pç	50	180	7	480	48
7187355	5/16" x 117 mm - 1 pç	7	227	90	300	30
7187455	3/8" x 125 mm - 1 pç	9	227	110	200	20
7187555	7/16" x 142 mm - 1 pç	11	227	120	200	20
7187655	1/2" x 151 mm - 1 pç	50	227	16	180	18



- Polida | Polished | Pulido
- Para metais ferrosos e não ferrosos | For ferrous and non-ferrous metals | Para metales ferrosos y no ferrosos
- Haste cilíndrica | Cylindrical rod | Vástago cilíndrico
- Aço de alta qualidade M2 | Stell M2 | Acero M2

Jogo de brocas HSS Professional Nitreto de Titânio

HSS Professional Drill | Broca HSS Professional



723839	DIMENSÕES SIZE TAMAÑO (MM)		80	Quant. Min.
	A	B		
	57	155		0

AUTO SERVIÇO



5 peças
parts | piezas



DIMENSÕES SIZE TAMAÑO (MM)	
A	B
3 mm	57
4 mm	75
5 mm	93
6 mm	93
8 mm	117

- Polida/Nitreto de Titânio | Polished / Titanium Nitride | Polida / Nitruro de Titânio
- Para metais ferrosos e não ferrosos | For ferrous and non-ferrous metals | Para metales ferrosos y no ferrosos
- Haste cilíndrica | Cylindrical Rod | Vástago cilíndrico
- Revestida com nitreto de titânio para duplicar a vida útil do produto e qualidade de corte | Coated with titanium nitride to double product life and cut quality | Revestida con nitruro de titânio para duplicar la vida útil del producto y la calidad de corte
- Embalagem: Caixa plástico | Packing: Plastic Box | Embalaje: Caja plástico

Jogo de Brocas para metal Nitreto de Titânio

Set of Metal Drills | Juego de Brocas para metal



723869	DIMENSÕES SIZE TAMAÑO (MM)		50	Quant. Min.
	A	B		
	108	215		0

AUTO SERVIÇO



13 peças
parts | piezas



DIMENSÕES SIZE TAMAÑO (MM)	
A	B
1,5 mm	48
2 mm	49
2,5 mm	57
3 mm	61
3,2 mm	70
3,5 mm	70
4 mm	75
4,5 mm	80
4,8 mm	80
5 mm	86
5,5 mm	93
6 mm	93
6,5 mm	101

- Polida/Nitreto de Titânio | Polished / Titanium Nitride | Polida / Nitruro de Titânio
- Para metais ferrosos e não ferrosos | For ferrous and non-ferrous metals | Para metales ferrosos y no ferrosos
- Haste cilíndrica | Cylindrical Rod | Vástago cilíndrico
- Revestida com nitreto de titânio para duplicar a vida útil do produto e qualidade de corte | Coated with titanium nitride to double product life and cut quality | Revestida con nitruro de titânio para duplicar la vida útil del producto y la calidad de corte
- Embalagem: Caixa plástico | Packing: Plastic Caixa | Embalaje: Caja plástico

Broca Escalonada HSS Nitreto de Titânio

HSS Stepper Drill | Broca Escalada HSS



Barcode	Dimensions	Quantity	Min. Quantity
723539	4-5-6-7-8-9-10-11-12mm	100	10
723569	4-6-8-10-12-14-16-18-20mm	100	10
723579	6-8-10-12-14-16-18-20-22-24-26-28-30mm	100	10
723589	9-12-15-18-21-24-27-30-33-36mm	100	10
723599	4-6-8-10-12-14-16-18-20-22-24-26-28-30-32mm	100	10

- Haste sextavada | Hexagon rod | Vástago hexagonal
- Alta precisão de furação | Hexagon rod | Vástago hexagonal

Suporte / haste de fixação para serra copo

Clamping bracket / stem for cup saw | Soporte / vástago de fijación para Sierra de agujero



Barcode	Dimensions	DIMENSÕES SIZE TAMAÑO (MM)		Quantity	Min. Quantity
		A	B		
724949	até 30mm	102	205	100	10
724969	acima de 31mm	103	215	60	10

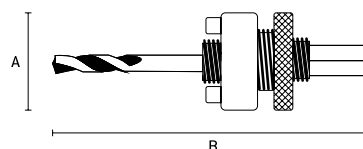

- Haste sextavada | Hexagon rod | Vástago hexagonal
- Indicada para fixar/sustentar a serra copo para realização do corte | Indicated for securing / holding the glass saw for cutting | Indicada para fijar / sostener la sierra vaso para realizar el corte
- Acompanha broca piloto (HSS) | Comes with pilot drill (HSS) | Acompaña broca piloto (HSS)
- Suporte em aço | Steel support | Soporte de acero
- Embalagem: Caixa | Packing: Carton | Embalaje: Caja

Serra copo aço rápido Bimetal / Easy Cut

Quick steel cup saw | Sierra de agujero de acero rápido

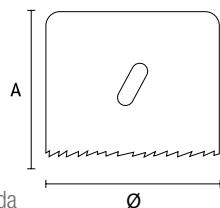

- 6 dentes por polegada | 6 teeth per inch | 6 dientes por pulgada
- Lâmina Bimetálica | Bimetallic Blade | Lámina Bimetálica
- Indicada para metais, plásticos, alumínio e inox | Suitable for metals | Indicada para metales
- Não acompanha haste/suporte | Does not include stem / support | No acompaña el vástago / soporte
- Dentes travados | Teeth locked | Dientes bloqueados
- Embalagem: Caixa | Packing: Carton | Embalaje: Caja

Barcode	Dimensions	DIMENSÕES SIZE TAMAÑO (MM)		Quantity	Min. Quantity
		A	Ø		
724149	14 mm	52	14	200	50
724169	16 mm	52	16	200	50
724199	19 mm	52	19	200	50
724229	22 mm	52	22	100	50
724259	25 mm	62	25	100	50
724299	29 mm	62	29	100	50
724329	32 mm	62	32	100	50
724339	33 mm	62	33	100	50
724359	35 mm	62	35	100	50
724389	38 mm	77	38	100	50
724409	40 mm	77	40	100	50
724419	41 mm	77	41	100	50
724449	44 mm	77	44	100	50
724489	48 mm	77	48	100	50
724519	51 mm	77	51	100	50
724549	54 mm	93	54	100	50
724579	57 mm	93	57	100	50
724609	60 mm	95	60	100	50
724649	64 mm	93	64	100	50
724679	67 mm	110	67	100	10
724689	68 mm	110	68	50	10
724709	70 mm	110	70	50	10
724739	73 mm	110	73	50	10
724769	76 mm	110	76	50	10
724789	78 mm	110	78	50	10
724809	80 mm	110	80	50	10
724839	83 mm	110	83	50	10
724869	86 mm	120	86	40	10
724899	89 mm	130	89	40	10
724919	102 mm	130	102	40	10
724939	105 mm	143	105	20	10
724959	114 mm	145	114	20	10
724979	121 mm	145	121	20	10
724989	127 mm	165	127	20	10
724999	140 mm	165	140	20	10

Jogo de Bits e Brocas

Set of Bits and Drills | Juego de Bits y Brocas



DIMENSÕES | SIZE | TAMAÑO (MM)

725779

A

B



20

0



300
peças
parts
pieces

Composição | Composition | composición:

- brocas de concreto | 5 pcs - 4 x 75 mm, 5 x 85 mm, 6 x 100 mm, 8 x 120 mm, 10 x 120 mm.
- brocas para metal | 7 pcs - 2 x 47 mm, 3 x 60 mm, 4 x 75 mm, 5 x 85 mm, 6 x 94 mm, 8 x 115 mm, 10 x 131 mm.
- brocas de madeira | 5 pcs - 4 x 75 mm, 5 x 85 mm, 6 x 95 mm, 8 x 114 mm, 10 x 120 mm.
- bits | 6 pcs - SL 4,5 x 25 mm, SL 6 x 25 mm, PH 1 x 25 mm, PH 2 x 25 mm, PZ 1 x 25 mm, PZ 2 x 25 mm.
- adaptador | 1 pc - 1/4" x 60 mm.
- buchas | 4 mm - 117 peças, 5 mm - 60 peças, 6 mm - 53 peças, 8 mm - 29 peças e 10 mm - 17 peças.

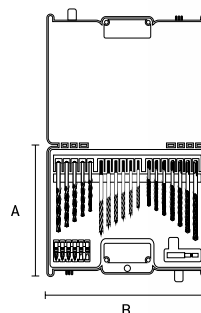

- Brocas para concreto, metal e madeira | Drills for concrete, metal and wood | Brocas para hormigón, metal y madera
- Adaptador magnético | Magnetic adapter | Adaptador magnético
- Bits | Bits | Bits
- Brocas para concerto de Wídea | Wídea concert drills | Brocas para concierto de Wídea
- Embalagem: Caixa plástico | Packing: Plastic Caixa | Embalaje: Caja plástico

Serra copo para vidro

Cup saw for glass | Sierra de agujero para vidrio



DIMENSÕES | SIZE | TAMAÑO (MM)

		A	B		Quant. Min.
726149	14 mm	14	67	240	40
726169	16 mm	16	67	240	40
726189	18 mm	18	67	240	40
726209	20 mm	20	67	240	40
726229	22 mm	22	67	180	30
726259	25 mm	25	67	180	30
726289	28 mm	28	67	96	24
726309	30 mm	30	67	96	24
726329	32 mm	32	67	108	18



BLISTER



- Diamantada | Diamond | Diamante
- Haste triangular | Triangular rod | Vástago triangular
- **Atenção: sempre que possível utilizar esta serra copo com refrigeração para aumentar a performance do produto |**
Caution: Whenever possible use this cooled glass saw to increase product performance |
Atención: siempre que sea posible utilizar esta sierra vaso con refrigeración para aumentar el rendimiento del producto
- Embalagem: Blister | Packing: Blister | Embalaje: Blister

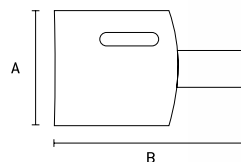

Broca para porcelanato

Porcelain drill bit | Broca para porcelana



DIMENSÕES | SIZE | TAMAÑO (MM)

		A	B		Quant. Min.
728139	3 mm	3	80	500	100
728149	4 mm	4	80	500	100
728159	5 mm	5	80	500	100
728169	6 mm	6	80	500	125
728189	8 mm	8	80	500	125
728209	10 mm	10	80	500	125



BLISTER



- Indicada para furar porcelanato, cêramica e vidro | Hexagon rod | Vástago hexagonal
- Haste cilíndrica | Comes with pilot drill (HSS) | Acompaña broca piloto (HSS)
- Embalagem: Blister | Packing: Blister | Embalaje: Blister

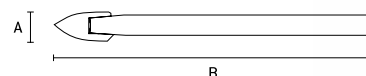

Serra copo para vidro e cerâmica

Cup Saw for glass and ceramics | Sierra de agujero para vidrio y cerámica



DIMENSÕES | SIZE | TAMAÑO (MM)

		A	B		Quant. Min.
7280455	4 mm	4	55	800	100
7280655	6 mm	6	55	800	100
7280855	8 mm	8	55	800	100
7281055	10 mm	10	55	800	100

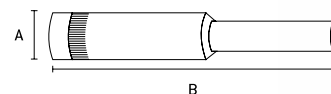

- Diamantada | Diamond | Diamante
- Haste cilíndrica | Cilindric rod | Vástago cilíndrica
- **Atenção: sempre que possível utilizar esta serra copo com refrigeração para aumentar a performance do produto |**
Caution: Whenever possible use this cooled glass saw to increase product performance |
Atención: siempre que sea posible utilizar esta sierra vaso con refrigeración para aumentar el rendimiento del producto
- Embalagem: Blister | Packing: Blister | Embalaje: Blister

Serra copo para cerâmica e telha

Ceramic cup saw and tile | Sierra de agujero para cerâmica y teja



AUTO SERVIÇO



		DIMENSÕES SIZE TAMAÑO (MM)			Quant. Min.
		A	B		
728469	33 mm	33	36	50	0
728489	53 mm	53	55	50	0
728529	67 mm	67	76	50	0
728549	73 mm	73	75	50	0
728569	83 mm	83	85	50	0

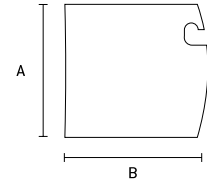

- Corpo em aço com serra diamantada | Steel body with diamond saw | Cuerpo en acero con sierra diamantada
- Indicada para cortar telhas, tijolos, cerâmicas, azulejos e vidros não temperados | Suitable for cutting tiles, bricks, ceramics, tiles and non-tempered glass | Vástago triangular
- Não acompanha haste / suporte | Does not include stem / support | No acompaña el vástago / soporte
- Embalagem: Caixa | Packing: Carton | Embalaje: Caja

Haste para suporte serra copo

Stem to support cup saw | Vástago para soporte Sierra de agujero



BLISTER



		DIMENSÕES SIZE TAMAÑO (MM)			Quant. Min.
		A	B		
728629	10 mm	10	200	125	25

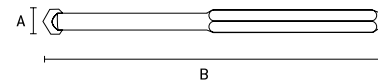

Suporte para serra copo

Cup saw holder | Soporte para Sierra de agujero



BLISTER



		DIMENSÕES SIZE TAMAÑO (MM)			Quant. Min.
		A	B		
728609	33 - 43 - 53 - 63 - 67 - 73 - 83 - 103 mm	10	160	50	5

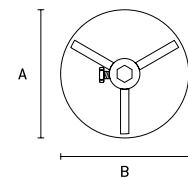

Jogo de serra copo para cerâmica e telha

Ceramic and tile glass saw set | Juego de Sierra de agujero para cerâmica y teja



		DIMENSÕES SIZE TAMAÑO (MM)			Quant. Min.
		A	B		
728429	33 mm	33	36	10	0
	53 mm	53	36		
	67 mm	67	36		
	73 mm	73	36		
	83 mm	83	36		

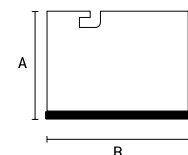

- Corpo metálico com serra diamantada | Metal body with diamond saw | Cuerpo metálico con sierra diamantada
- Indicada para cortar telhas, tijolos, cerâmicas e azulejos | Indicated for cutting tiles, bricks, ceramics and tiles | Indicada para cortar tejas, ladrillos, cerâmicas y azulejos
- Haste sextavada | Hexagon rod | Vástago hexagonal

Rebolos diamantados
Diamond wheels | Rebolos diamantados

AUTO
SERVIÇO



729059	segmentado duas linhas D115 mm	DIMENSÕES SIZE TAMAÑO (MM)		10
		Ø	Quant. Min.	
729099	turbo D115 mm	115	20	10
729139	turbo / segmentado D115 mm	115	20	10



• 729059
segmentado duas linhas D115 |
segmented two lines D115 | segmentado dos líneas D115



• 729139
turbo / segmentado D115 mm |
turbo / segmented D115 mm | turbo / segmentado D115 mm

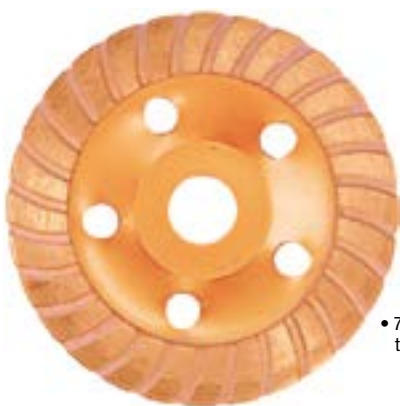

• 729099
turbo | turbo | turbo

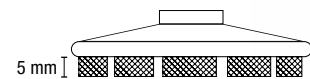
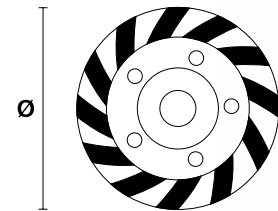
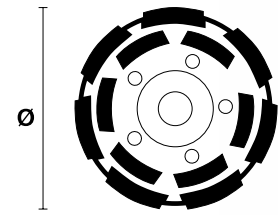

Rosca M14 |
Thread M14 |
Rosca M14



- Indicado para desbaste de mármore, granito, concreto, pedras, tijolo e para polimento | Indicado para desbaste de mármore, granito, concreto, piedras, afilado y pulido | Indicado para desbaste de mármore, granito, concreto, piedras, afilado y pulido
- Utilizado para esmerilhadeiras 4.1/2" - 115 mm | Used for grinders 4.1 / 2" - 115 mm | Utilizado para esmeriladoras 4.1 / 2" - 115 mm
- Rosca M14 | Thread M14 | Rosca M14
- Rotação máxima : 10.500 rpm | Maximum rotation: 10,500 rpm | Rotación máxima: 10.500 rpm
- Embalagem: Caixa | Packing: Carton | Embalaje: Caja
- Alto rendimento | High yield | Alto rendimiento



Discos de serra circular

Circular Saw Blades | Discos de sierra circular



	Barcode	Description	DIMENSÕES SIZE TAMANHO (MM)		Box	Quant. Min.
			A	B		
7322355		7,1/4" (185 mm) - 24 dentes	20	185	50	0
7327855		7,1/4" (185 mm) - 36 dentes	20	185	50	0
7326155		7,1/4" (185 mm) - 24 dentes	22,23	185	50	0
7326255		7,1/4" (185 mm) - 36 dentes	22,23	185	50	0
7326355		7,1/4" (185 mm) - 48 dentes	22,23	185	50	0
7326455		7,1/4" (185 mm) - 60 dentes	22,23	185	50	0
7326555		9,1/4" (230 mm) - 24 dentes	25,4	230	25	0
7326655		9,1/4" (230 mm) - 36 dentes	25,4	230	25	0
7326755		9,1/4" (230 mm) - 48 dentes	25,4	230	25	0
7326855		9,1/4" (230 mm) - 60 dentes	25,4	230	25	0
7324155		4,3/8" (110 mm) - 24 dentes	22,23	110	100	0
7324255		4,3/8" (110 mm) - 40 dentes	22,23	110	100	0
7327555		12" (305 mm) - 36 dentes	30	305	12	0
7327755		12" (305 mm) - 48 dentes	30	305	12	0
7328055		12" (305 mm) - 60 dentes	30	305	12	0
7328755		12" (305 mm) - 96 dentes	30	305	12	0
7329155		14" (350 mm) - 48 dentes	30	350	10	0
7329355		14" (350 mm) - 60 dentes	30	350	10	0
7329555		14" (350 mm) - 96 dentes	30	350	10	0

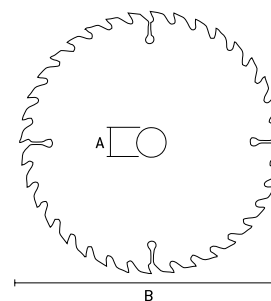

- Wídea | Wídea | Wídea
- Uso Profissional | Professional use | Uso profesional
- Não deixa lascas no canto | Does not leave splinters in the corner | No deja astillas en la esquina
- Com bucha de redução para 16 e 20 mm | With reduction sleeve for 16 and 20 mm | Con manguito de reducción de 16 - 20 mm

Discos de serra circular para Alumínio

Circular Saw Blades for Aluminum | Discos de sierra circular para Aluminio



	Barcode	Description	DIMENSÕES SIZE TAMANHO (MM)		Box	Quant. Min.
			A	B		
7338155		7,1/4" (185 mm) x 3/4" (20 mm) - 60 dentes	20	185	60	30
7338255		10" (250 mm) x 1,1/4" (30 mm) - 80 dentes	20	250	20	10
7338355		12" (300 mm) x 1,1/4" (30 mm) - 96 dentes	22,23	300	20	0

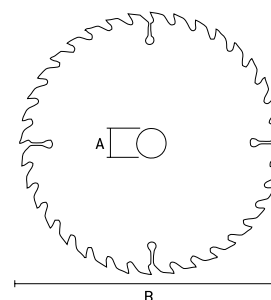

- Wídea | Wídea | Wídea
- Uso Profissional | Professional use | Uso profesional

Discos de corte diamantados Segmentado

Diamond Cutting Discs | Discos de corte diamantados



NOVO	C/S	DIMENSÕES SIZE TAMANHO (MM)		Quant. Min.	
		A	B		
7310555	115 x 2,0 x 22,2 mm	22,2	115	100	10
7311155	180 x 2,4 x 22,2 mm	22,2	180	50	10

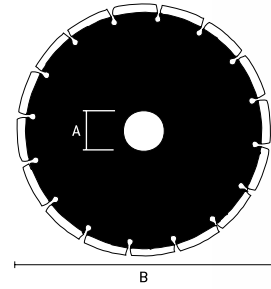

- Segmentado | Segmented | Segmentado
- Utilizado em serra mármore | Used in marble saw | Utilizado en sierra de mármol
- Indicado para mármore, granito, concreto e alvenaria | Suitable for marble, granite, concrete and masonry | Indicado para mármol, granito, hormigón y albañilería
- Corte a seco | Dry cut | Corte en seco
- **Atenção: os discos de corte seco, quando refrigerados proporcionam um melhor rendimento |**
Caution: Dry-cut discs, when cooled, provide better performance |
Atención: los discos de corte seco, cuando refrigerados proporcionan un mejor rendimiento

Discos de corte diamantados Linha Premium Segmentado

Diamond Cutting Discs | Discos de corte diamantados

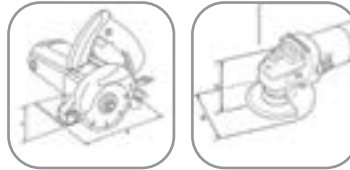

NOVO	C/S	DIMENSÕES SIZE TAMANHO (MM)		Quant. Min.	
		A	B		
731729	115 x 2,0 x 22,2 mm	22,2	115	100	10
731779	230 x 2,4 x 22,2 mm	22,2	230	25	5

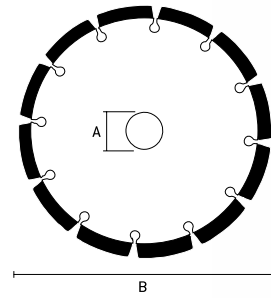

- Segmentado | Segmented | Segmentado
- Utilizado em serra mármore | Used in marble saw | Utilizado en sierra de mármol
- Utilização em esmerilhadeira disco de 115 mm | Use in 115 mm disk grinder | Uso en esmeriladora disco de 115 mm
- Indicado para mármore, granito, concreto e alvenaria | Suitable for marble, granite, concrete and masonry | Indicado para mármol, granito, hormigón y albañilería
- Corte a seco | Dry cut | Corte en seco
- **Atenção: os discos de corte seco, quando refrigerados proporcionam um melhor rendimento |**
Caution: Dry-cut discs, when cooled, provide better performance |
Atención: los discos de corte seco, cuando refrigerados proporcionan un mejor rendimiento

Discos de corte diamantados Segmentado

Diamond Cutting Discs | Discos de corte diamantados



NOVO	C/S	DIMENSÕES SIZE TAMANHO (MM)		Quant. Min.	
		A	B		
731049	110 x 2,0 x 20,0 mm	20	110	100	10
731119	180 x 2,4 x 25,4 mm	25,4	180	50	10
731699	230 x 2,4 x 25,4 mm	25,4	230	25	0
731659	350 x 3,0 x 25,4 mm	25,4	350	10	0

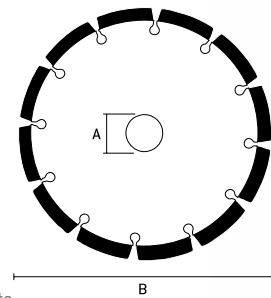

- Segmentado | Segmented | Segmentado
- Utilizado em serra mármore | Used in marble saw | Utilizado en sierra de mármol
- Dureza diferenciada na área de corte | Differential hardness in the cutting area | Dureza diferenciada en el área de corte
- Indicado para mármore, granito, concreto e alvenaria | Suitable for marble, granite, concrete and masonry | Indicado para mármol, granito, hormigón y albañilería
- Corte a seco | Dry cut | Corte en seco
- **Atenção: os discos de corte seco, quando refrigerados proporcionam um melhor rendimento |**
Caution: Dry-cut discs, when cooled, provide better performance |
Atención: los discos de corte seco, cuando refrigerados proporcionan un mejor rendimiento

Discos de corte diamantados Turbo

Diamond Cutting Discs | Discos de corte diamantados

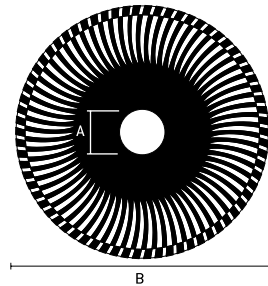
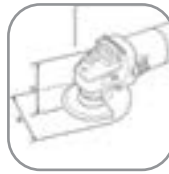

NOVO	CS	DIMENSÕES SIZE TAMAÑO (MM)		Quant. Min.	
		A	B		
7311755	115 x 2,0 x 22,2 mm	22,2	115	100	10
7312355	180 x 2,4 x 22,2 mm	22,2	180	50	10

- Turbo | Turbo | Turbo
- Utilizado em serra mármore | Used in marble saw | Utilizado en sierra de mármol
- Indicado para cerâmica | Suitable for ceramics | Indicado para la cerámica
- NÃO indicado para porcelanato | NOT suitable for porcelain tile | NO indicado para porcelanato
- Corte a seco | Dry cut | Corte en seco
- **Atenção: os discos de corte seco, quando refrigerados proporcionam um melhor rendimento |**
Caution: Dry-cut discs, when cooled, provide better performance |
Atención: los discos de corte seco, cuando refrigerados proporcionan un mejor rendimiento

Discos de corte diamantados Turbo

Diamond Cutting Discs | Discos de corte diamantados



CS	DIMENSÕES SIZE TAMAÑO (MM)	Quant. Min.
731169	110 x 2,0 x 20,0 mm	10
731239	180 x 2,4 x 25,4 mm	10
731709	230 x 2,4 x 25,4 mm	5

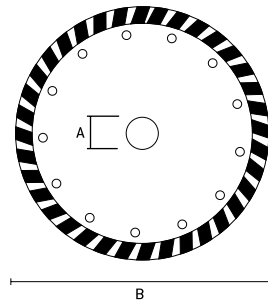

- Turbo | Turbo | Turbo
- Dureza diferenciada na área de corte | Differential hardness in the cutting area | Dureza diferenciada en el área de corte
- Utilizado em serra mármore | Used in marble saw | Utilizado en sierra de mármol
- Indicado para cerâmica | Suitable for ceramics | Indicado para la cerámica
- NÃO indicado para porcelanato | NOT suitable for porcelain tile | NO indicado para porcelanato
- Acompanha buchas de redução e anéis de adaptação | Comes with reduction bushings and adaptation rings | Acompaña los casquillos de reducción y los anillos de adaptación
- Corte a seco | Dry cut | Corte en seco
- **Atenção: os discos de corte seco, quando refrigerados proporcionam um melhor rendimento |**
Caution: Dry-cut discs, when cooled, provide better performance |
Atención: los discos de corte seco, cuando refrigerados proporcionan un mejor rendimiento

Discos de corte diamantados Linha Premium Turbo

Diamond Cutting Discs | Discos de corte diamantados

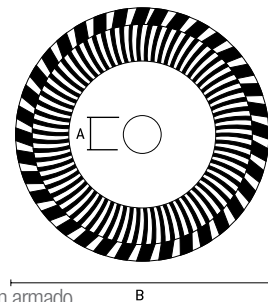

CS	DIMENSÕES SIZE TAMAÑO (MM)	Quant. Min.
731789	115 x 2,0 x 22,2 mm	10
731839	230 x 2,4 x 22,2 mm	5

- Turbo | Turbo | Turbo
- Utilizado em serra mármore, concreto armado | Used in marble saw, reinforced concrete | Utilizado en sierra de mármol, hormigón armado
- NÃO indicado para porcelanato | NOT suitable for porcelain tile | NO indicado para porcelanato
- Acompanha buchas de redução e anéis de adaptação | Comes with reduction bushings and adaptation rings | Acompaña los casquillos de reducción y los anillos de adaptación
- Corte a seco | Dry cut | Corte en seco
- **Atenção: os discos de corte seco, quando refrigerados proporcionam um melhor rendimento |**
Caution: Dry-cut discs, when cooled, provide better performance |
Atención: los discos de corte seco, cuando refrigerados proporcionan un mejor rendimiento

Discos de corte diamantados Linha Premium Turbo/Segmentado

Diamond Cutting Discs | Discos de corte diamantados

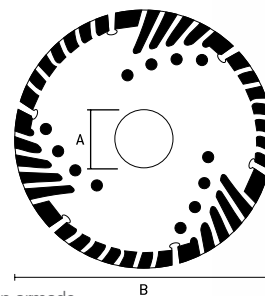

Código	Dimensões	DIMENSÕES SIZE TAMANHO (MM)		Quant. Min.
		A	B	
731529	115 x 2,0 x 22,2 mm	22,2	115	10
731559	180 x 2,4 x 22,2 mm	22,2	180	10

- Turbo | Turbo | Turbo
- Utilizado em serra mármore, concreto armado | Used in marble saw, reinforced concrete | Utilizado en sierra de mármol, hormigón armado
- NÃO indicado para porcelanato | NOT suitable for porcelain tile | NO indicado para porcelanato
- Acompanha buchas de redução e anéis de adaptação | Comes with reduction bushings and adaptation rings | Acompaña los casquillos de reducción y los anillos de adaptación
- Corte a seco | Dry cut | Corte en seco
- **Atenção: os discos de corte seco, quando refrigerados proporcionam um melhor rendimento |**
Caution: Dry-cut discs, when cooled, provide better performance |
Atención: los discos de corte seco, cuando refrigerados proporcionan un mejor rendimiento

Discos de corte diamantados Liso

Diamond Cutting Discs | Discos de corte diamantados



Código	Dimensões	DIMENSÕES SIZE TAMANHO (MM)		Quant. Min.
		A	B	
731389	110 x 2,0 x 20,0 mm	20	110	10
731499	180 x 2,4 x 25,4 mm	25,4	180	10
731929	230 x 2,4 x 25,4 mm	25,4	230	5

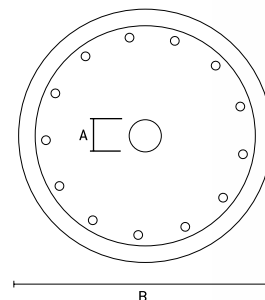

- Contínuo | Continuous | Continuo
- Dureza diferenciada na área de corte | Differential hardness in the cutting area | Dureza diferenciada en el área de corte
- Utilizado em serra mármore | Used in marble saw | Utilizado en sierra de mármol
- Indicado para mármore e granito | Suitable for marble and granite | Indicado para mármol y granito
- Acompanha buchas de redução e anéis de adaptação | Comes with reduction bushings and adaptation rings | Acompaña los casquillos de reducción y los anillos de adaptación
- Corte refrigerado | Refrigerated cutting | Corte refrigerado
- Embalagem: Blister | Packing: Blister | Embalaje: Blister

Discos de corte diamantados Linha Premium Liso

Diamond Cutting Discs | Discos de corte diamantados

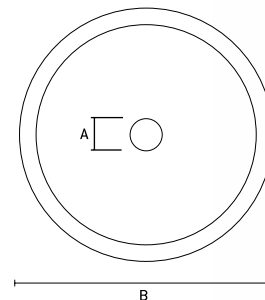

Código	Dimensões	DIMENSÕES SIZE TAMANHO (MM)		Quant. Min.
		A	B	
731849	115 x 2,0 x 22,2 mm	22,2	115	10
731919	230 x 2,4 x 22,2 mm	22,2	230	5

- Contínuo | Continuous | Continuo
- Utilizado em serra mármore | Used in marble saw | Utilizado en sierra de mármol
- Dureza diferenciada na área de corte | Differential hardness in the cutting area | Dureza diferenciada en el área de corte
- Indicado para mármore, granito, concreto e alvenaria | Suitable for marble, granite, concrete and masonry | Indicado para mármol, granito, hormigón y albañilería
- Corte a seco | Dry cut | Corte en seco
- **Atenção: os discos de corte seco, quando refrigerados proporcionam um melhor rendimento |**
Caution: Dry-cut discs, when cooled, provide better performance |
Atención: los discos de corte seco, cuando refrigerados proporcionan un mejor rendimiento

Discos de corte diamantados

Diamond Cutting Discs | Discos de corte diamantados



NOVO		NOVO		DIMENSÕES SIZE TAMAÑO (MM)		Quant. Min.	
731475		7313955		A	B		
		115 x 2,0 x 22,2 mm		22,2	115	100	10
		180 x 2,4 x 22,2 mm		22,2	180	100	10

AUTO SERVIÇO

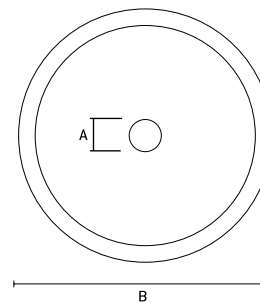

- Contínuo | Continuous | Continuo
- Dureza diferenciada na área de corte | Differential hardness in the cutting area | Dureza diferenciada en el área de corte
- Utilizado em serra mármore | Used in marble saw | Utilizado en sierra de mármol
- Indicado para mármore e granito | Suitable for marble and granite | Indicado para mármol y granito
- Acompanha buchas de redução e anéis de adaptação | Comes with reduction bushings and adaptation rings | Acompaña los casquillos de reducción y los anillos de adaptación
- Corte refrigerado | Refrigerated cutting | Corte refrigerado
- Embalagem: Blister | Packing: Blister | Embalaje: Blister

Adaptador para boina

Adapter for beret | Adaptador para boina



762909		rosca M14		DIMENSÕES SIZE TAMAÑO (MM)		Quant. Min.	
				A	B		
				6 8	115	500	0



BLISTER

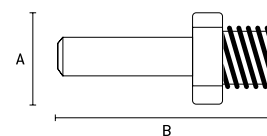

- Adaptador para a instalação de suporte de boina | Adapter for the installation of | Adaptador para la instalación de
- Feito em aço carbono | Made of carbon steel | Hecho en acero al carbono

Suporte de boina

Beret holder | Soporte de boina



762189		115 mm		DIMENSÕES SIZE TAMAÑO (MM)		Quant. Min.	
762209		125 mm		A	B		
				130	115	100	0
				140	125	100	0

AUTO SERVIÇO

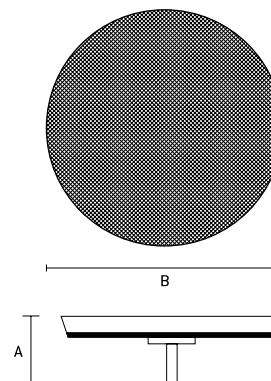

- Com velcro | With velcro | Con el velcro
- Para furadeira e maquinário elétrico | For drill and electric machinery | Para taladro y maquinaria eléctrica
- Embalagem: Blister | Packing: Blister | Embalaje: Blister

Discos de lixa com velcro

Sanding discs with velcro | Discos de lixa com velcro

AUTO-SERVIÇO



DIMENSÕES | SIZE | TAMAÑO (MM)



		Ø		
738009	grão 24	125	200	0
738019	grão 36	125	200	0
738029	grão 40	125	200	0
738039	grão 60	125	200	0
738049	grão 80	125	200	0
738059	grão 100	125	200	0
738069	grão 120	125	200	0
738079	grão 150	125	200	0
738089	grão 180	125	200	0
738099	grão 220	125	200	0

5 peças
parts | piezas

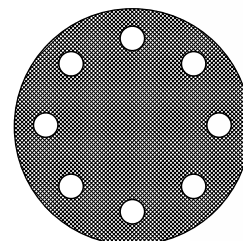

- Costado de fibra com velcro | Velcro fiber side | Costado de fibra con velcro
- Perfurado | Perforated | Perforado
- Utilizado em máquinas angulares rotativas de acionamento elétrico ou pneumático |
Used in rotary angular electric or pneumatic drive machines |
Utilizado en máquinas angulares rotativas de accionamiento eléctrico o neumático
- Aplicações em estruturas metálicas, indústria naval, fundições de metais ferrosos e indústria automobilística |
Applications in metal structures, shipbuilding, ferrous metal foundries and the automotive industry |
Aplicaciones en estructuras metálicas, industria naval, fundiciones de metales ferrosos e industria automovilística

Discos de lixa

Sanding discs | Discos de lixa

AUTO-SERVIÇO



DIMENSÕES | SIZE | TAMAÑO (MM)



		Ø		
738109	grão 24	115	100	10
738159	grão 40	115	100	10
738209	grão 60	115	100	10
738259	grão 80	115	100	10
738309	grão 24	125	100	10
738339	grão 36	125	100	10
738359	grão 40	125	100	10
738409	grão 60	125	100	10
738459	grão 80	125	100	10
738509	grão 100	125	100	10
738559	grão 120	125	100	10
738609	grão 150	125	100	10
738659	grão 180	125	100	10
738709	grão 220	125	100	10

10 peças
parts | piezas

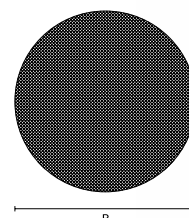

- Costado de fibra com velcro | Velcro fiber side | Costado de fibra con velcro
- Utilizado em máquinas angulares rotativas de acionamento elétrico ou pneumático |
Used in rotary angular electric or pneumatic drive machines |
Utilizado en máquinas angulares rotativas de accionamiento eléctrico o neumático
- Aplicações em estruturas metálicas, indústria naval, fundições de metais ferrosos e indústria automobilística |
Applications in metal structures, shipbuilding, ferrous metal foundries and the automotive industry |
Aplicaciones en estructuras metálicas, industria naval, fundiciones de metales ferrosos e industria automovilística

Rodas de lixa

Sandpaper wheels | Ruedas de lixa



DIMENSÕES | SIZE | TAMAÑO (MM)



		A	B	C		
741109	grão 40	60	20	6	240	0
741129	grão 60	60	20	6	240	0
741149	grão 80	60	20	6	240	0
741209	grão 40	60	30	6	200	0
741229	grão 60	60	30	6	200	0
741249	grão 80	60	30	6	120	0
741409	grão 40	80	30	6	100	0
741429	grão 60	80	30	6	100	0
741449	grão 80	80	30	6	100	0
741509	grão 40	80	40	6	100	0
741529	grão 60	80	40	6	100	0
741549	grão 80	80	40	6	100	0

- Para furadeira | For drilling | Para taladro
- Com haste | With stem | Con barra
- Adaptável em lixadeiras para torno e furadeiras elétricas |
Adaptable in lathe grinders and electric drills | Adaptable en lijadoras para torno y taladros eléctricos
- Utilizada no desbaste e acabamento de superfícies planas, contornos e partes internas |
Used in the roughing and finishing of flat surfaces, contours and internal parts |
Utilizada en el desbaste y acabado de superficies planas, contornos y partes internas
- Indicado para aço, ferro, plástico e alumínio |
Suitable for steel, iron, plastic and aluminum | Indicado para acero, hierro, plástico y aluminio

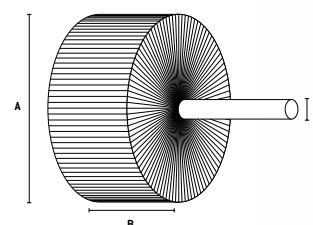

Discos de desbaste

Roughing discs | Discos de desbaste



DIMENSÕES SIZE TAMANHO (MM)	DIMENSÕES SIZE TAMANHO (MM)			Quant. Min.	
	A	B	C		
7376255	22,2	115	4,8	100	25
7376455	22,2	125	6,4	100	25
7377255	22,2	125	6	100	25
7379155	22,2	180	6,4	50	25

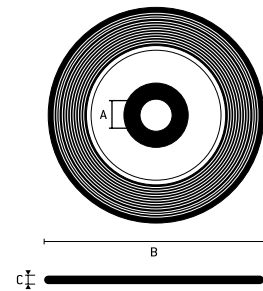

- Indicado para desbastes em metais ferrosos com esmerilhadeira angular | Indicated for slabs in ferrous metals with angle grinder | Indicado para desbaste em metais ferrosos con esmeriladora angular
- Alta durabilidade, qualidade e segurança | High durability, quality and safety | Alta durabilidad, calidad y seguridad

Discos de desbaste óxido de alumínio

Roughing discs | Discos de desbaste



DIMENSÕES SIZE TAMANHO (MM)	DIMENSÕES SIZE TAMANHO (MM)		Quant. Min.	
	A	B		
740269 grão 25	22	115	160	0
740279 grão 40	22	115	240	0
740289 grão 60	22	115	240	0
740299 grão 80	22	115	240	0
740319 grão 100	22	115	240	0
740329 grão 120	22	115	240	0

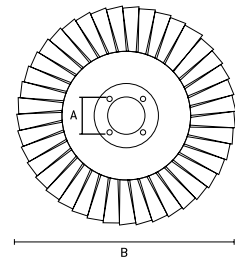

- Indicado para acabamento em aço inox, alumínio, metais ferrosos e não ferrosos, madeira e plástico | Indicated for finishing in stainless steel, aluminum, ferrous and non-ferrous metals, wood and plastic | Indicado para acabado en acero inoxidable, aluminio, metales ferrosos y no ferrosos, madera y plástico
- Utilizado em máquinas angulares rotativas de acionamento elétrico ou pneumático | Used in rotating angular machines of electric or pneumatic drive | Utilizado en máquinas angulares rotativas de accionamiento eléctrico o neumático
- Aplicações em estruturas metálicas, indústria naval, fundições de metais ferrosos e indústria automobilística | Applications in metal structures, shipbuilding, ferrous metal foundries and the automotive industry | Aplicaciones en estructuras metálicas, industria naval, fundiciones de metales ferrosos e industria automovilística
- 13.300 rpm

Discos de desbaste "FLAP" zircônio

Roughing discs "FLAP" zirconium | Discos de desbaste "FLAP" zirconio



DIMENSÕES SIZE TAMANHO (MM)	DIMENSÕES SIZE TAMANHO (MM)		Quant. Min.	
	A	B		
7401555 grão 36	22	115	200	0
7401655 grão 40	22	115	200	0
7401755 grão 60	22	115	200	0
7401855 grão 80	22	115	200	0
7401955 grão 100	22	115	200	0
7402355 grão 120	22	115	200	0

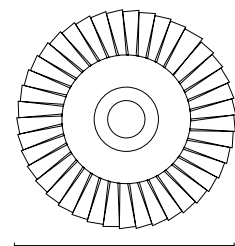

- Indicado para acabamento em aço inox, alumínio, metais ferrosos e não ferrosos, madeira e plástico | Indicated for finishing in stainless steel, aluminum, ferrous and non-ferrous metals, wood and plastic | Indicado para acabado en acero inoxidable, aluminio, metales ferrosos y no ferrosos, madera y plástico.
- De Zircônio | Of Zirconium | De Zirconio
- 13.300 rpm

Disco de corte Inox/ Metal

Stainless Steel Cutting Disc/Metal | Disco de corte Inox/ Metal



Barcode	SKU	DIMENSÕES SIZE TAMAÑO (MM)			C	Quant. Min.
		A	B	C		
7375255	115 x 1,0 x 22 mm	22	115	1,0	400	100
7375455	115 x 1,6 x 22 mm	22	115	1,6	400	100
7378155	180 x 1,6 x 22 mm	22	180	1,6	200	50

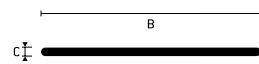
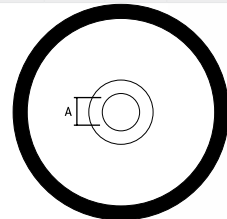

- **Reforçado com 2 telas** | Reinforced with 2 screens | Reforzado con 2 pantallas
- **Aplicação: eficaz em aço inox e metais ferrosos e não ferrosos** | Application: effective in stainless steel and ferrous and non-ferrous metals | Aplicación: eficaz en acero inoxidable y metales ferrosos y no ferrosos
- **Corte rápido e limpo** | Fast and clean cutting | Corte rápido y limpio
- **Não queima e não deixa manchas na peça** | Does not burn and does not leave stains on the part | No se quema y no deja manchas en la pieza
- **Proporciona menos esforço e aumenta a vida útil da máquina** | Provides less effort and increases machine life | Proporciona menos esfuerzo y aumenta la vida útil de la máquina

Disco de corte Metal

Stainless Steel Cutting Disc/Metal | Disco de corte Metal



Barcode	SKU	DIMENSÕES SIZE TAMAÑO (MM)			C	Quant. Min.
		A	B	C		
7432655	115 x 1,0 x 22 mm	22	115	1,0	400	100
7432855	115 x 1,6 x 22 mm	22	115	1,6	400	100
7434755	180 x 1,6 x 22 mm	22	180	1,6	200	50

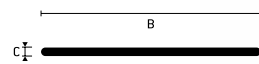
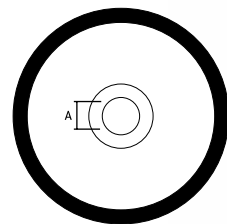

- **Metal** | Metal | Metal
- **Reforçado com 2 telas** | Reinforced with 2 screens | Reforzado con 2 pantallas
- **Aplicação: eficaz para corte de metais ferrosos em geral, ferro fundido e ferro fundido modular** | Application: effective for cutting ferrous metals in general, cast iron and cast iron modular | Aplicación: eficaz para corte de metales ferrosos en general, hierro fundido y hierro fundido modular
- **Dura muito mais do que as maiorias dos abrasivos existentes** | Lasts much longer than most existing abrasives | Dura mucho más que las mayorías de los abrasivos existentes.
- **Proporciona menor esforço ao operador alta produtividade** | Provides lower effort to operator high productivity | Proporciona menor esfuerzo al operador de alta productividad
- **Qualidade de corte: Rápido e limpo, com menos rebarbas** | Calidad de corte: Rápido y limpio, con menos rebabas | Calidad de corte: Rápido y limpio, con menos rebabas

Disco de corte Inox/ Metal

Stainless Steel Cutting Disc/Metal | Disco de corte Inox/ Metal



Barcode	SKU	DIMENSÕES SIZE TAMAÑO (MM)			C	Quant. Min.
		A	B	C		
7436155	115 x 1,0 x 22 mm	22	115	1,0	400	100
7436355	115 x 1,6 x 22 mm	22	115	1,6	400	100
7438255	180 x 1,6 x 22 mm	22	180	1,6	200	50

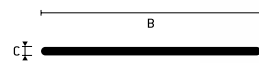
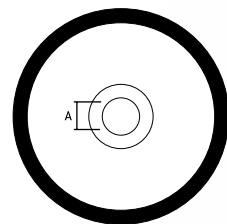

- **Pureza química de material, reforçado pelo 2 telas, sem queimar ou arranhar a peça, sem formação de rebarbas e descoloração** | Chemical purity of material, reinforced by 2 screens, without burning or scratching the part, without burr formation and discoloration | Pureza química de material, reforzado por las 2 pantallas, sin quemar o rayar la pieza, sin formación de rebabas y decoloración
- **Altíssima qualidade de corte para as obras mais exigentes** | Highest cutting quality for the most demanding works | Altísima calidad de corte para las obras más exigentes
- **Duração extremamente elevada para inox** | Extremely high lifetime for stainless steel | Duración extremadamente elevada para inox
- **Os produto atendem as exigências mais rigorosas de segurança** | Products meet the most stringent safety requirements | Los productos cumplen los requisitos más estrictos de seguridad



Escovas circulares Latonada com haste

Circular Brushes | Cepillos circulares



BLISTER



Código	SSC	DIMENSÕES SIZE TAMAÑO (MM)		Quant. Min.
		A		
744449	2" (50 mm)	50	240	24
744469	2.3/8" (60 mm)	60	120	10
744489	3" (75 mm)	75	120	12
744509	4" (100 mm)	100	120	12

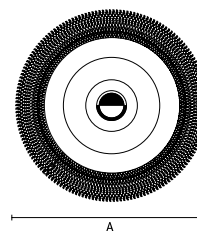

- Haste diâmetro 1/4" | Rod diameter 1/4 " | Vástago de diâmetro 1/4 "
- Aço carbono latonado | Brass carbon steel | Acero al carbono latonado
- Rotação máxima: 12500 rpm | Maximum rotation: 12500 rpm | Rotación máxima: 12500 rpm
- Embalagem: Blister | Packing: Blister | Embalaje: Blister

Escovas circulares onduladas

Circular Brushes | Cepillos circulares



AUTO SERVIÇO



Código	SSC	DIMENSÕES SIZE TAMAÑO (MM)		Quant. Min.
		A		
746089	4" (100 mm)	135	60	0
746169	5" (125 mm)	165	60	0

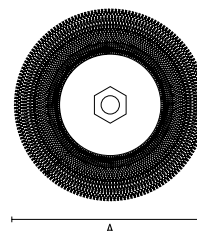

- Onduladas | Wavy | Corrugado
- Aço carbono polido | Polished carbon steel | Acero al carbono pulido
- Rotação máxima: 12500 rpm | Maximum rotation: 12500 rpm | Rotación máxima: 12500 rpm
- Rosca: M14 | Thread: M14 | Rosca: M14
- Embalagem: Caixa (Autosserviço) | Packaging: Cash (Self-service) | Embalaje: Caja (Autoservicio)

Escovas circulares torcidas

Circular Brushes | Cepillos circulares



AUTO SERVIÇO



Código	SSC	DIMENSÕES SIZE TAMAÑO (MM)		Quant. Min.
		A		
746309	4" (100 mm)	100	100	0
746329	5" (125 mm)	125	60	0
746349	6" (150 mm)	150	40	0
746369	7" (175 mm)	175	20	0
746389	8" (200 mm)	200	20	0

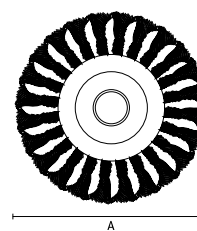

- Torcidas | Wavy | Corrugado
- Aço carbono polido | Polished carbon steel | Acero al carbono pulido
- Rotação máxima: 12500 rpm | Maximum rotation: 12500 rpm | Rotación máxima: 12500 rpm
- Furo: 7/8" (22mm) | Bore: 7/8 "(22mm) | Agujero: 7/8 "(22mm)
- Embalagem: Caixa (Autosserviço) | Packaging: Cash (Self-service) | Embalaje: Caja (Autoservicio)

Escovas circulares latonadas

Circular Brushes | Cepillos circulares



AUTO SERVIÇO



Código	SSC	DIMENSÕES SIZE TAMAÑO (MM)		Quant. Min.
		A		
746489	4" (100 mm)	100	100	0
746649	6" (150 mm)	150	60	0
746669	7" (175 mm)	175	40	0

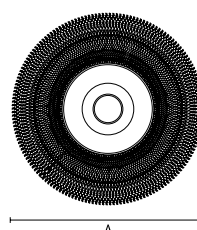

- Onduladas | Wavy | Corrugado
- Aço carbono latonado | Brass carbon steel | Acero al carbono latonado
- Rotação máxima: 4500 rpm | Maximum rotation: 4500 rpm | Rotación máxima: 4500 rpm
- Furo: 7/8" (22mm) | Bore: 7/8 "(22mm) | Agujero: 7/8 "(22mm)
- Embalagem: Caixa (Autosserviço) | Packaging: Cash (Self-service) | Embalaje: Caja (Autoservicio)

Escovas tipo copo torcidas com haste

Cup Brushes | Cepillos tipo vaso



BLISTER



Código	Tamanho	DIMENSÕES SIZE TAMAÑO (MM)		Quant. Min.
		A	B	
744689	2.1/2" (65 mm)	65	130	12
744709	3" (75 mm)	75	140	12

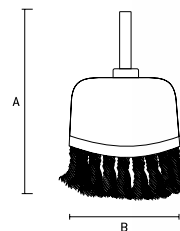

- Torcidas | Wavy | Corrugado
- Aço carbono polido | Polished carbon steel | Acero al carbono pulido
- Haste diâmetro 1/4" | Rod diameter 1/4 " | Vástago de diâmetro 1/4 "
- Embalagem: Caixa (Autosserviço) | Packaging: Cash (Self-service) | Embalaje: Caja (Autoservicio)

Escovas tipo copo latonadas com haste

Cup Brushes | Cepillos tipo vaso



BLISTER



Código	Tamanho	DIMENSÕES SIZE TAMAÑO (MM)		Quant. Min.
		A	B	
744759	2" (50 mm)	50	115	12
744789	3" (75 mm)	75	140	12

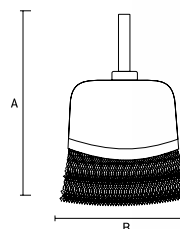

- Aço carbono latonado | Brass carbon steel | Acero al carbono latonado
- Haste diâmetro 1/4" | Rod diameter 1/4 " | Vástago de diâmetro 1/4 "
- Embalagem: Blister | Packing: Blister | Embalaje: Blister

Escovas tipo copo latonadas com rosca

Cup Brushes | Cepillos tipo vaso



AUTO SERVIÇO



Código	Tamanho	DIMENSÕES SIZE TAMAÑO (MM)		Quant. Min.
		A	B	
746049	3" (75 mm)	75	110	0
746059	4" (100 mm)	100	135	0
746069	5" (125 mm)	125	160	0

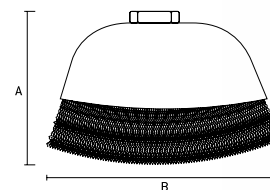

- Onduladas | Wavy | Corrugado
- Aço carbono latonado | Brass carbon steel | Acero al carbono latonado
- Rotação máxima: 10000 rpm | Maximum rotation: 10000 rpm | Rotación máxima: 10000 rpm
- Rosca: M14 | Thread: M14 | Rosca: M14
- Embalagem: Caixa (Autosserviço) | Packaging: Cash (Self-service) | Embalaje: Caja (Autoservicio)

Escovas tipo copo torcidas com rosca

Cup Brushes | Cepillos tipo vaso



AUTO SERVIÇO



Código	Tamanho	DIMENSÕES SIZE TAMAÑO (MM)		Quant. Min.
		A	B	
746209	2.1/2" (65 mm)	65	100	0
746249	3" (75 mm)	75	110	0
746289	4" (100 mm)	100	140	0
746299	6" (150 mm)	150	200	0

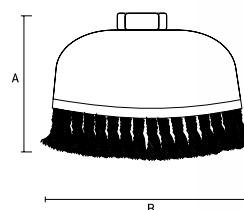

- Torcidas | Wavy | Corrugado
- Aço carbono polido | Polished carbon steel | Acero al carbono pulido
- Rotação máxima: 10000 rpm | Maximum rotation: 10000 rpm | Rotación máxima: 10000 rpm
- Rosca: M14 | Thread: M14 | Rosca: M14
- Embalagem: Caixa (Autosserviço) | Packaging: Cash (Self-service) | Embalaje: Caja (Autoservicio)

Jogo de escovas circulares onduladas com haste

Set of circular wavy brushes | Juego de cepillos circulares ondulados



Composição | Composition | Composición
 • 1 plana 4" (100 mm)
 • 1 tipo copo 3" (75 mm)

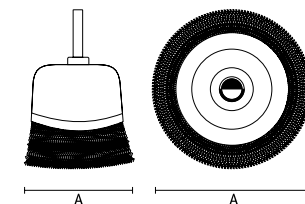

744809	PLANA FLAT TIPO COPO CUP TYPE	DIMENSÕES SIZE TAMAÑO (MM)	40	10
		A		

- Aço carbono latonado | Brass carbon steel | Acero al carbono latonado
- Haste diâmetro 1/4" | Rod diameter 1/4 " | Vástago de diâmetro 1/4 "
- Embalagem: Blister | Packing: Blister | Embalaje: Blister

Jogo de escovas

Set of brushes | Juego de cepillos



Composição | Composition | Composición
 • 1 plana 2" 1/2" (65 mm) com haste
 • 1 tipo copo 2 1/2" 65 mm com haste
 • 1 manual (120 mm)

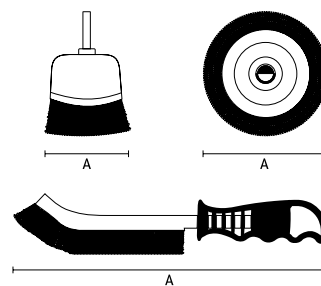

744849	PLANA FLAT TIPO COPO CUP TYPE MANUAL	DIMENSÕES SIZE TAMAÑO (MM)	40	10
		A		
		120		

- Aço carbono latonado | Brass carbon steel | Acero al carbono latonado
- Haste diâmetro 1/4" | Rod diameter 1/4 " | Vástago de diâmetro 1/4 "
- Embalagem: Blister | Packing: Blister | Embalaje: Blister

Jogo de escovas circulares onduladas

Set of circular wavy brushes | Juego de cepillos circulares ondulados



Composição | Composition | Composición
 1 plana 2" (50 mm)
 • 2 tipo copo 1" (25 mm) e 2" (50 mm)

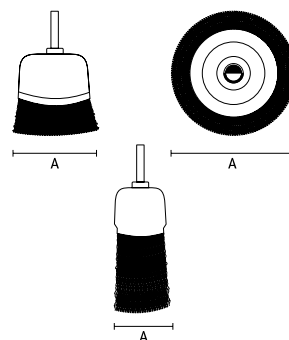

744869	PLANA FLAT TIPO COPO CUP TYPE TIPO COPO CUP TYPE	DIMENSÕES SIZE TAMAÑO (MM)	120	12
		A		
		50		

- Aço carbono latonado | Brass carbon steel | Acero al carbono latonado
- Haste diâmetro 1/4" | Rod diameter 1/4 " | Vástago de diâmetro 1/4 "
- Embalagem: Blister | Packing: Blister | Embalaje: Blister

Escova Manual

Hand brush | Cepillo Manual

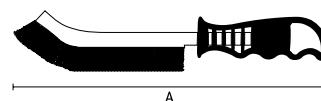

antigo	748505	7485055	DIMENSÕES SIZE TAMAÑO (MM)	180	10
			A		

- Aço carbono latonado | Brass carbon steel | Acero al carbono latonado
- Pequena | Little | Pequeño

Escova pincel com haste

Steel Brush | Cepillo Pincel



DIMENSÕES | SIZE | TAMAÑO (MM)

7448555

A



Quant. Min.

240 12

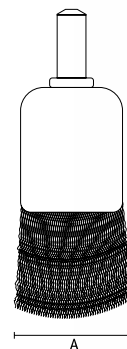

- Aço carbono | Carbon steel | Acero carbono
- Haste diâmetro 1/4" | Rod diameter 1/4 " | Vástago de diâmetro 1/4 "
- Embalagem: Blister | Packing: Blister | Embalaje: Blister

Escovas Manuais - Jogo

hand brushes - set | cepillos manuales - conjunto



DIMENSÕES | SIZE | TAMAÑO (MM)

748609

A

B



Quant. Min.

120 12

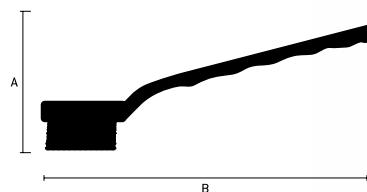

- Aço carbono | Carbon steel | Acero carbono
- Tamanho Pequena | Small size | Tamaño pequeño
- Cabo Plástico | Plastic Cable | Mango de plástico
- Embalagem: Blister | Packing: Blister | Embalaje: Blister

Escovas Manuais - Jogo

hand brushes - set | cepillos manuales - conjunto



DIMENSÕES | SIZE | TAMAÑO (MM)

748639

A

B



Quant. Min.

120 12

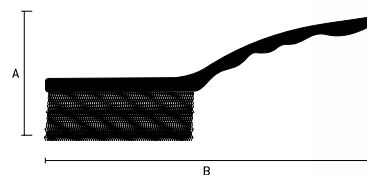

- Aço carbono | Carbon steel | Acero carbono
- Tamanho Grande | Big size | Tamaño grande
- Cabo Plástico | Plastic Cable | Mango de plástico
- Embalagem: Blister | Packing: Blister | Embalaje: Blister

Escova manual

Hand brush | Cepillo manual



DIMENSÕES | SIZE | TAMAÑO (MM)

7486655

4 Fileiras

A

B



Quant. Min.

120 12

7486755

5 Fileiras

40

270

120 12

7486855

6 Fileiras

40

270

120 12

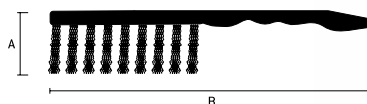

- Aço carbono | Carbon steel | Acero carbono
- Cabo de plástico | Plastic cable | Cable de plástico

Escova de aço

Steel brush | Cepillo de acero



NOVO	DIMENSÕES SIZE TAMANHO (MM)	DIMENSÕES SIZE TAMANHO (MM)		Quant. Min.		
		A	B			
7482055	3 Fileiras	40	290	30	120	12
7482255	4 Fileiras	40	290	40	120	12
7482455	5 Fileiras	40	290	40	120	12
7482655	6 Fileiras	40	290	40	120	12

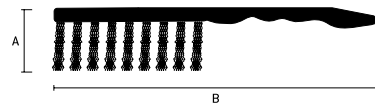

- Aço carbono | Carbon steel | Acero carbono
- Cabo de madeira | Wooden handle | Cable de madera

Jogo de Pontas montadas

Set of mounted tips | Juego de puntas montadas



NOVO	DIMENSÕES SIZE TAMANHO (MM)	Quant. Min.	
760209	5 peças	120	40

AUTO SERVIÇO



5 peças
parts | piezas

- Utilizado em retificadeiras | Used in rectifiers | Utilizado en rectificadoras
- Óxido de alumínio | Aluminum Oxide | Óxido de aluminio
- Indicada para retificar e desbastar pequenas peças com retificadeiras em ferramentaria, fundições, acabamento de furos | Indicated for grinding and thinning small parts with rectifiers in tooling, foundries, finishing of holes | Indicada para retificar y desbastar pequeñas piezas con rectificadoras en herramientas, fundiciones, acabado de agujeros
- Embalagem: Blister | Packing: Blister | Embalaje: Blister

Pedras de afiar

Sharpening stones | Piedras de afilado



NOVO	DIMENSÕES SIZE TAMANHO (MM)		Quant. Min.	
	A	B		
7641555	50	150	50	0
7642055	51	200	50	0

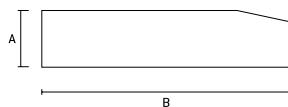

- Double side | Metal cable | Mango de metal
- Retângular | Rectangular | Rectangular
- Embalagem: Caixa | Packing: Box | Embalaje: Caja

Pedras de afiar

Sharpening stones | Piedras de afilado



NOVO	DIMENSÕES SIZE TAMANHO (MM)		Quant. Min.	
	A	B		
7642555	41	230	100	0

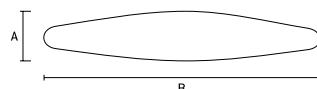

- Oval | Oval | Oval
- Embalagem: Caixa | Packing: Box | Embalaje: Caja

Lixa

Sandpaper | Papel de lija

AUTO SERVIÇO



756069	grão 80	DIMENSÕES SIZE TAMANHO (MM)		100	0*
		A	B		
		220	270		

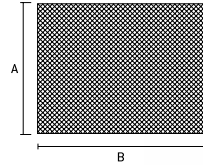

- Massa, Alvenaria e madeira | Spackling, Masonry and wood | Masa de carreras, Albañilería y madera
- Costado de papel | Paper side | Lado de papel
- Embalagem: Blister | Packing: Blister | Embalaje: Blister

Lixa

Sandpaper | Papel de lija

AUTO SERVIÇO



7560455	grão 60	DIMENSÕES SIZE TAMANHO (MM)		100	0
		A	B		
7560655	grão 80	230	280	100	0
7560855	grão 100	230	280	100	0
7561055	grão 120	230	280	100	0
7561255	grão 180	230	280	100	0
7561455	grão 240	230	280	100	0
7561655	grão 320	230	280	100	0
7561855	grão 400	230	280	100	0
7562055	grão 600	230	280	100	0
7562255	grão 800	230	280	100	0
7562455	grão 1000	230	280	100	0
7562855	grão 1500	230	280	100	0
7562955	grão 2000	230	280	100	0

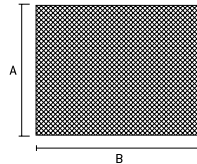

- Metal | Metal | Metal
- Costado de papel | Paper side | Lado de papel
- Embalagem: Blister | Packing: Blister | Embalaje: Blister

Lixa

Sandpaper | Papel de lija

AUTO SERVIÇO



7563355	grão 40	DIMENSÕES SIZE TAMANHO (MM)		25	0
		A	B		
7563955	grão 60	230	280	25	0
7564155	grão 80	230	280	25	0
7564355	grão 100	230	280	25	0
7564555	grão 120	230	280	25	0

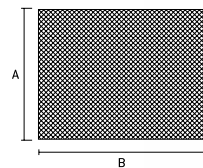

- Metal | Metal | Metal
- Costado de tecido | Fabric side | Lado de tejido
- Embalagem: Blister | Packing: Blister | Embalaje: Blister

Taco lixador

Sanding pad | Taco lijador



7581055	DIMENSÕES SIZE TAMANHO (MM)		100	0
	A	B		
	125	65		



- Borracha | Rubber | Caucho
- Suporte para fixação de lixa | Support for fixing sandpaper | Soporte para fijación de lija

Macho

Male | Masculino



- Aço rápido | Fast Iron | Acero rápido
- Padrão internacional 4h | 4h international standard | Estándar internacional 4h
- Embalagem: Blister | Packing: Blister | Embalaje: Blister



766719	m4	DIMENSÕES SIZE TAMAÑO (MM)		500	125
		A	B		
766739	m5	0,7	153	500	125
766759	m6	0,8	153	500	125
766779	m8	1,0	153	500	125
766929	m8	1,25	160	500	125
766929	m10	1,5	160	500	125
766969	m12	1,75	160	200	0

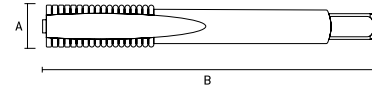

Vira macho

Male Tool | Macho Herramienta



- Tipo <T> | Type <T> | Tipo <T>
- Com catraca | With ratchet | Con carraca
- Cromado | Chrome plated | Cromo
- Embalagem: Blister | Packing: Blister | Embalaje: Blister



769059	M3-M8	DIMENSÕES SIZE TAMAÑO (MM)		120	0
		A	B		
769079	M5-M12	60	155	75	0

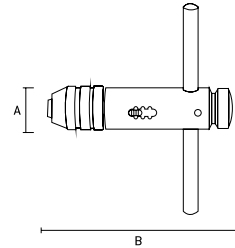

Vira macho

Male Tool | Macho Herramienta



- Reto | Straight | Directamente



7691255	M3-M12	DIMENSÕES SIZE TAMAÑO (MM)		150	5
		A	B		
7692055 <td>M6-M20</td> <td>65</td> <td>200</td> <td>36</td> <td>4</td>	M6-M20	65	200	36	4

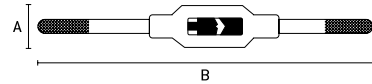

Cossinetes

Cossinetes | Dies



- Aço rápido com molibdênio | Rapid steel with molybdenum | Acero rápido con molibdeno
- Padrão internacional 4h | 4h international standard | Estándar internacional 4h
- Embalagem: Blister | Packing: Blister | Embalaje: Blister



770719	m4	DIMENSÕES SIZE TAMAÑO (MM)		500	25
		A	B		
770739	m5	0,7	70	500	125
770759	m6	0,8	70	500	125
770779	m8	1,0	70	500	125
770929	m8	1,25	70	500	125
770929	m10	1,5	70	500	125
770969	m12	1,75	70	200	50

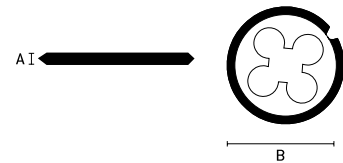

Porta Cossinetes

Door Cossinetes | Puerta Cossinetes



- Reto | Straight | Directamente



7742055	M3 - M6	DIMENSÕES SIZE TAMAÑO (MM)		200	5
		A	B		
7742555	M8	(20mm)	183	120	5
7743855	M12 - M14	(25 mm)	210	48	4
7745055	M16 - M20	(38mm)	293	32	4
		(45mm)	250		

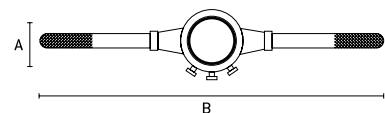

Jogo de tarraxas para canos metálicos

Set of metal pipe fittings | Juego de taras para tuberías metálicas



NOVO 7733055	DIMENSÕES SIZE TAMAÑO (MM)		Quant. Min.
	A	B	
	180	240	0

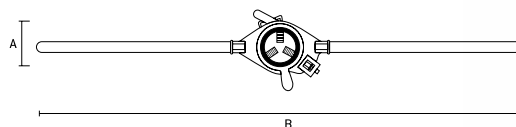

- Embalagem: Caixa | Packing: Box | Embalaje: Caja
- 1/2" - 3/4", 1" - 1 1/4", 1 1/4", 1 1/2" - 2"

Jogo de tarraxas para canos metálicos

Set of metal pipe fittings | Juego de taras para tuberías metálicas



NOVO 7733455	maleta 360X470mm	2	Quant. Min.

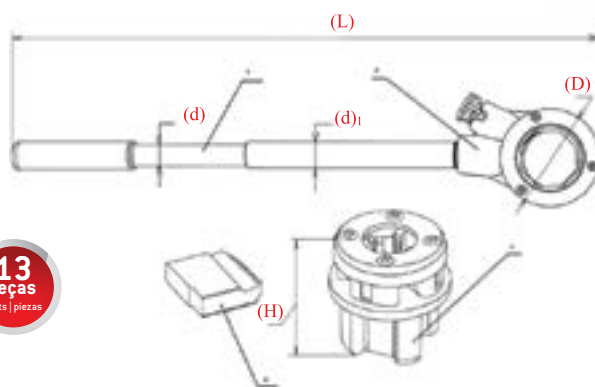

13
peças
parts | piezas

1-Cabo; 2-Corpo da base; 3-Mandril para cortadores; 4-Pestana de corte.

Codigo	Tamanho da Tarraxa	(H)	(D)	(d)	(d ₁)	(L)	Peso líquido, Gr.
773345	1/4"	65	80	22	25,5	530	538
	1/2"	68					650
	3/4"	67					622
	3/8"	63					830
	1"	72					1100
	1.1/4"	74					834

- Embalagem: Caixa | Packing: Box | Embalaje: Caja
- Rosca BSP | Screw Thread BSP | Tornillo BSP



JOGO DE TARRAXAS PARA CANOS METÁLICOS

Set of metal pipe fittings | Juego de taras para tuberías metálicas

USADO NA CONSTRUÇÃO CIVIL PARA FAZER ROSCAS EM TUBOS DE DIVERSOS DIÂMETROS.

FABRICADO EM AÇO CARBONO.



Estilete

Stiletto | Estilete



			DIMENSÕES SIZE TAMAÑO (MM)			
78870	7887055	5 lâminas	A	B	36	Quant. Min. 6

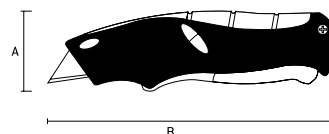

- Cabo três componentes | Cable with three components | Mango con tres componentes
- Mecanismo automático de recolhimento da lâmina | Automatic blade take-up mechanism | Mecanismo automático de recogida de la hoja
- Compartimento para lâminas | Blade compartment | Compartimiento para hojas
- Embalagem: Blister | Packing: Blister | Embalaje: Blister

Estiletos 170mm

Stiletto 170mm | Estiletos 170mm



		DIMENSÕES SIZE TAMAÑO (MM)			
7888255	2 lâminas	A	B	36	Quant. Min. 6

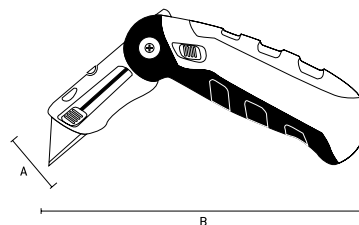

- Uso Profissional | Professional Use | Uso Profesional
- Corpo metálico | Metal body | Cuerpo metálico
- Guia lâmina aço carbono | Carbon Steel Blade Guide | Guía de hoja de acero al carbono
- Dobrável com lâmina trapezoidal | Folding with trapezoidal blade | Plegable con lâmina trapezoidal
- Botão de trava e destrava para fechamento do estilete | Lock and unlock button for stylus closure | Botón de bloqueo y desbloqueo para cerrar el estilete
- Compartimento com 2 lâminas | Compartment with 2 blades | Compartimiento con 2 cuchillas
- Indicado para corte de papel, papelão e outros materiais | Suitable for cutting paper, cardboard and other materials | Indicado para corte de papel, cartón y otros materiales

Estiletos 170mm

Stiletto 170mm | Estiletos 170mm



			DIMENSÕES SIZE TAMAÑO (MM)			
78885	788855	2 lâminas	A	B	72	Quant. Min. 12

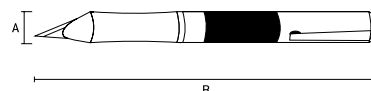

- Uso Profissional | Professional Use | Uso Profesional
- Corpo metálico | Metal body | Cuerpo metálico
- Sistema caneta de fechamento da lâmina | Blade closing pen system | Sistema pluma de cierre de la hoja
- Compartimento com 2 lâminas | Compartment with 2 blades | Compartimiento con 2 cuchillas
- Sistema de trava e destrava para fechamento do estilete | Lock and unlock system for stylus closure | Sistema de bloqueo y desbloqueo para cierre del estilete
- Indicado para corte de papel, papelão e outros materiais | Suitable for cutting paper, cardboard and other materials | Indicado para corte de papel, cartón y otros materiales

Lâmina para estilete

Stiletto blade | Láminas para estilete



		DIMENSÕES SIZE TAMAÑO (MM)			
79376	7937655	A	B	144	Quant. Min. 6

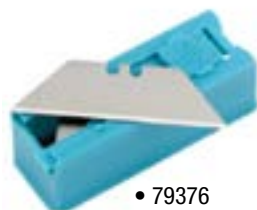

• 79376

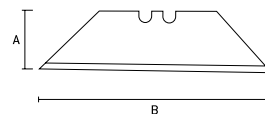

- Lâminas para estiletos e raspadores trapezoidais | Blades for styli and trapezoidal scrapers | Láminas para estiletos y raspadores trapezoidales
- Indicado para os produtos | Indicated for products | Indicado para los productos 78870, 78876, 78882, 789009, 789649, 789679
- Embalagem: Caixa Plástica | Packing: Plastic Box | Embalaje: Caja Plástica

Estiletos

Stiletto | Estilete

AUTO
SERVIÇO



789149	DIMENSÕES SIZE TAMAÑO (MM)		144	12
	A	B		
	18	217		

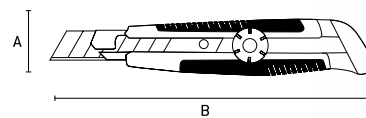

- **Usos Profissionais** | Professional Use | Uso Profesional
- **Corpo metálico** | Metal body | Cuerpo metálico
- **Lâmina retrátil** | Retractable blade | Láminas retráctiles
- **Botão de trava e destrava para lâmina** | Lock and unlock button for blade | Botón de bloqueo y desbloqueo para lámina
- **Embalagem: Blister** | Packing: Blister | Embalaje: Blister

Estiletos

Stiletto | Estilete

AUTO
SERVIÇO



789189	DIMENSÕES SIZE TAMAÑO (MM)		288	24
	A	B		
	18	220		

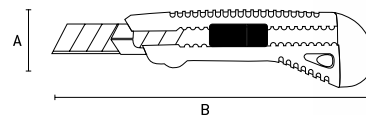

- **Usos Profissionais** | Professional Use | Uso Profesional
- **Corpo metálico body** | Metal Cuerpo metálico
- **Lâmina retrátil** | Retractable blade | Láminas retráctiles
- **Botão de trava e destrava para lâmina** | Lock and unlock button for blade | Botón de bloqueo y desbloqueo para lámina
- **Embalagem: Blister** | Packing: Blister | Embalaje: Blister

Estiletos

Stiletto | Estilete

AUTO
SERVIÇO



789369	DIMENSÕES SIZE TAMAÑO (MM)		144	12
	A	B		
	18	215		

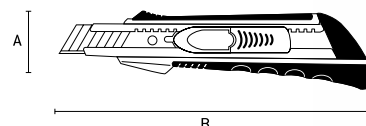

- **Corpo de metal reforçado** | Reinforced metal body | Cuerpo de metal reforzado
- **Sistema para corte de os e cabos** | Cable and wire cutting system | Sistema para corte de cables y cables
- **Botão de trava e destrava para lâmina** | Lock and unlock button for blade | Botón de bloqueo y desbloqueo para lámina
- **Indicado para corte de papel, papelão e outros materiais** | Suitable for cutting paper, cardboard and other materials | Indicado para corte de papel, cartón y otros materiales
- **Embalagem: Blister** | Packing: Blister | Embalaje: Blister

Sistema QUICK BLADE |
QUICK BLADE system |
Sistema QUICK BLADE



Estiletos

Stiletto | Estilete

BLISTER



789599	DIMENSÕES SIZE TAMAÑO (MM)		72	6
	A	B		
	25	250		

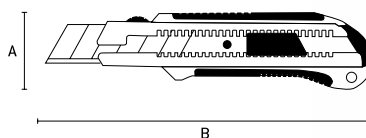

- **Usos Profissionais** | Professional Use | Uso Profesional
- **Corpo metálico** | Metal body | Cuerpo metálico
- **Lâmina retrátil** | Retractable blade | Láminas retráctiles
- **Botão de trava e destrava para lâmina** | Lock and unlock button for blade | Botón de bloqueo y desbloqueo para lámina
- **Embalagem: Blister** | Packing: Blister | Embalaje: Blister

Lâminas para estiletos

Stitching blades | Láminas para estiletos



AUTO SERVIÇO



NOVO	DIMENSÕES SIZE TAMANHO (MM)		Quant. Min.
	A	B	
7896855	9	100	20
7896955	18	120	10

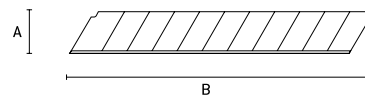

• Embalagem: tubete com furo expositor com 10 lâminas | Packaging: cartridge with 10-blade display hole | Embalaje: tubo con agujero expositor con 10 láminas

Estiletos

Stiletto | Estiletos



AUTO SERVIÇO



NOVO	DIMENSÕES SIZE TAMANHO (MM)		Quant. Min.
	A	B	
7897155	9	140	50

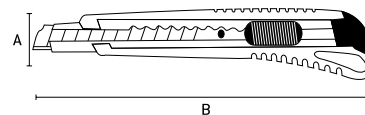

- **Usos Gerais** | General Use | Uso General
- **Corpo plástico com guia de metal** | Plastic body with metal guide | Cuerpo plástico con guía de metal
- **Lâmina retrátil** | Retractable blade | Láminas retráctiles
- **Botão para travamento da lâmina** | Blade Lock Button | Botón de bloqueo de la hoja
- **Embalagem: Blister** | Packing: Blister | Embalaje: Blister

Estiletos

Stiletto | Estiletos



AUTO SERVIÇO



NOVO	DIMENSÕES SIZE TAMANHO (MM)		Quant. Min.
	A	B	
7897255	9	150	60
7897455	18	215	60

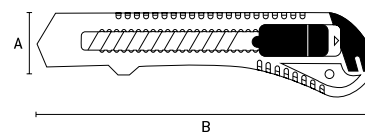
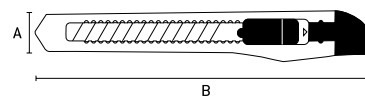

- **Usos Gerais** | General Use | Uso General
- **Corpo plástico** | Plastic body | Cuerpo plástico
- **Lâmina retrátil** | Retractable blade | Láminas retráctiles
- **Botão para travamento da lâmina** | Blade Lock Button | Botón de bloqueo de la hoja
- **Embalagem: Blister** | Packing: Blister | Embalaje: Blister

Jogo de estiletos

Stiletto set | Juego de estiletes



789859	288	12	



Composição:

- .01 estilete de 9 mm para uso geral.
- .01 estilete de 9 mm reforçado.
- .01 estilete de 18 mm reforçado.

- Lâminas retráteis e substituíveis | Retractable and replaceable blades | Láminas retractables y reemplazables
- Corpo plástico | Plastic body | Cuerpo plástico
- Embalagem: Blister | Packing: Blister | Embalaje: Blister

Jogo de estiletos

Stiletto set | Juego de estiletes



789919	4 unid. 9mm 2 unid. 18mm 2 unid. 40 e 62mm	96	0



Composição:

- .01 mini estilete para uso geral.
- .01 mini estilete de 9 mm para uso geral.
- .01 estilete de 9 mm para uso geral.
- .01 estilete de 9 mm reforçado.
- .01 estilete de 18 mm reforçado.
- .01 estilete com lâmina trapezoidal.
- .01 raspador de rejunte com lâmina fixa
- .01 raspador de rejunte com lâmina retrátil.

- Lâminas retráteis e substituíveis | Retractable and replaceable blades | Láminas retractables y reemplazables
- Corpo plástico | Plastic body | Cuerpo plástico
- Embalagem: Blister | Packing: Blister | Embalaje: Blister

Lâminas para estiletos

Stitching blades | Láminas para estiletes



	DIMENSÕES SIZE TAMAÑO (MM)			
	A	B		
7931159	9	101	800	20
7933159	18	121	300	10
7933259	25	146	100	10

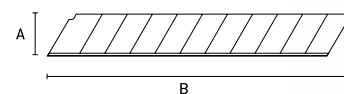

- Embalagem: tubete com furo expositor com 10 lâminas | Packaging: cartridge with 10-blade display hole | Embalaje: tubo con agujero expositor con 10 láminas

Lâminas para estiletos trapezoidais

Vane blades for trapezoidal style | Láminas para estiletes trapezoidales



	DIMENSÕES SIZE TAMAÑO (MM)			
	A	B		
7935559	9	68	480	40

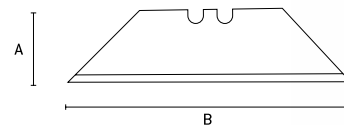

- Lâminas trapezoidal indicada para estiletos trapezoidais e raspadores | Trapezoidal blades indicated for trapezoidal styli and scrapers | Láminas trapezoidal indicada para estiletes trapezoidales y raspadores
- Embalagem : tubete com 5 lâminas | Packing: cartridge with 5 blades | Embalaje: tubo con 5 láminas
- Indicado para os produtos | Indicated for products | Indicado para los productos 789249, 789009, 789649, 789679
- Embalagem: caixa plástica | Packing: plastic box | Embalaje: caja plástica

Lâminas Serras

Saw blades | Láminas Sierras

AUTO SERVIÇO



777749	18 tpi	DIMENSÕES SIZE TAMAÑO (MM)		500	0
		A	B		
777729	24 tpi	40	300	500	0



• 777749
AC



• 777729
HSS

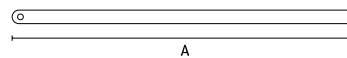

- Para arco de serra | For sawing bow | Para arco de sierra
- Embalagem: Blister | Packing: Blister | Embalaje: Blister

Lâminas para serra tico tico - Jogo

Saw Blades for Tactical Saw - Set | Láminas para sierra tico tico - Juego



781409	50 x 1,2 mm	DIMENSÕES SIZE TAMAÑO (MM)		200	20
		A			
781419	75 x 2,5 mm	75		200	20
781429	90 x 4,0 mm	90		200	20

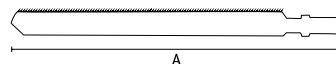

- Aço Carbono | Carbon steel | Acero carbono
- Encaixe para maquinário Bosc, AEG, Makita, Dewalt, Metabo | Bosch fitting | Encaje bosch
- Indicada para trabalhos com madeira maciça, compensados e plástico | Suitable for woodworking | Indicada para trabajos con madera
- Embalagem: Blister | Packing: Blister | Embalaje: Blister

Lâminas para serra tico tico - Jogo

Saw Blades for Tactical Saw - Set | Láminas para sierra tico tico - Juego



781509	75 x 1,2 mm, BIM	DIMENSÕES SIZE TAMAÑO (MM)		200	20
		A			
		75		200	20

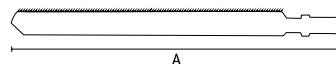

- Aço rápido bimetálico | Bimetal fast steel | Acero rápido bimetálico
- Encaixe para maquinário Bosc, AEG, Makita, Dewalt, Metabo | Bosch fitting | Encaje bosch
- Indicada para trabalhos com metais ferrosos e não ferrosos madeira maciça, compensados, MDF e plástico | Indicated for work with ferrous and non-ferrous metals | Indicada para trabajos con metales ferrosos y no ferrosos
- Embalagem: Blister | Packing: Blister | Embalaje: Blister

Jogo para serra tico tico

Tico-tico saw set | Juego para sierra Tico-tico



BLISTER



782019	T101B, 75 x 2,5 mm, HCS	DIMENSÕES SIZE TAMAÑO (MM)		200	50
		A			
782029	T101D, 75 x 4,0 mm, HCS	75	200	200	0



3 peças
parts | piezas

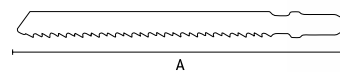

- Aço Carbono | Carbon steel | Acero carbono
- Encaixe bosch | Bosch fitting | Encaje bosch
- Indicada para trabalhos com madeira | Suitable for woodworking | Indicada para trabajos con madera
- Embalagem: Blister | Packing: Blister | Embalaje: Blister

Jogo para serra tico tico

Tico-tico saw set | Juego para sierra Tico-tico



BLISTER



782039	T101BR, 75 x 2,5 mm, HCS	DIMENSÕES SIZE TAMAÑO (MM)		200	0
		A			
782049	T144D, 75 x 4,0 mm, HCS	75	200	200	0



3 peças
parts | piezas

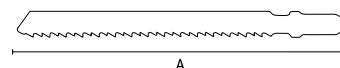

- Aço Carbono | Carbon steel | Acero carbono
- Encaixe bosch | Bosch fitting | Encaje bosch
- Indicada para trabalhos com madeira | Suitable for woodworking | Indicada para trabajos con madera
- Embalagem: Blister | Packing: Blister | Embalaje: Blister

Jogo para serra tico tico

Tico-tico saw set | Juego para sierra Tico-tico



BLISTER



782059	T111C, 75 x 3,0 mm, HCS	DIMENSÕES SIZE TAMAÑO (MM)		200	50*
		A			
782069	T118G, 50 x 0,8 mm, HSS	80	72	72	0



3 peças
parts | piezas

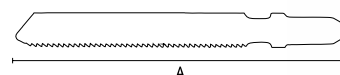

- Aço Carbono | Carbon steel | Acero carbono
- Encaixe bosch | Bosch fitting | Encaje bosch
- Embalagem: Blister | Packing: Blister | Embalaje: Blister



Jogo para serra tico tico

Tico-tico saw set | Juego para sierra Tico-tico



BLISTER



Código	Descrição	DIMENSÕES SIZE TAMAÑO (MM)			Quant. Min.
		A	B		
782079	T118A, 50 x 1,2 mm, HSS	50	200	0	
782089	T127D, 75 x 3,0 mm, HSS	75	200	0	

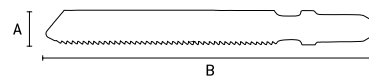
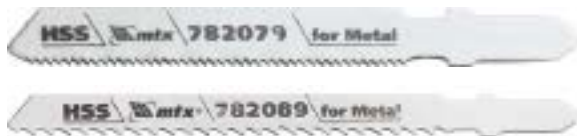

- Aço Carbono | Carbon steel | Acero carbono
- Encaixe bosch | Bosch fitting | Encaje bosch
- Embalagem: Blister | Packing: Blister | Embalaje: Blister

Jogo para serra tico tico

Tico-tico saw set | Juego para sierra Tico-tico



BLISTER



Código	Descrição	DIMENSÕES SIZE TAMAÑO (MM)			Quant. Min.
		A	B		
782099	T118AF, 55 x 1,2 mm, Bimetal	55	200	25	
782109	T101A0, 50 x 1,4 mm, HCS	50	200	25	

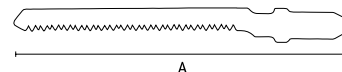

- Aço Carbono | Carbon steel | Acero carbono
- Encaixe bosch | Bosch fitting | Encaje bosch
- Indicada para trabalhos com serrar madeira, compensados, aglomerados de partículas, MDF | Suitable for sawing wood, plywood, particleboard, MDF | Indicada para trabajos con aserrar madera, compensados, aglomerados de partículas, MDF
- Embalagem: Blister | Packing: Blister | Embalaje: Blister

Jogo para serra tico tico

Tico-tico saw set | Juego para sierra Tico-tico



BLISTER



Código	Descrição	DIMENSÕES SIZE TAMAÑO (MM)			Quant. Min.
		A	B		
782119	T101BF, 75 x 2,5 mm, Bimetal	75	200	50	
782139	T101BRF, 75 x 2,5 mm, Bimetal	75	200	0	

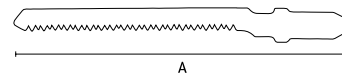

- Aço Carbono | Carbon steel | Acero carbono
- Encaixe bosch | Bosch fitting | Encaje bosch
- Indicada para trabalhos com serrar madeira, compensados, aglomerados de partículas, MDF | Suitable for sawing wood, plywood, particleboard, MDF | Indicada para trabajos con aserrar madera, compensados, aglomerados de partículas, MDF
- Embalagem: Blister | Packing: Blister | Embalaje: Blister

Jogo para serra tico tico

Tico-tico saw set | Juego para sierra Tico-tico



DIMENSÕES | SIZE | TAMAÑO (MM)



782159

T244D, 75 x 4,0 mm, HCS

75

200

50



BLISTER

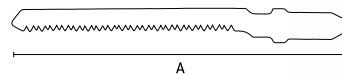
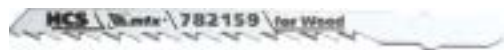

- Aço Carbono | Carbon steel | Acero carbono
- Encaixe bosch | Bosch fitting | Encaje bosch
- Indicada para trabalhos com serrar madeira, compensados, aglomerados de partículas, MDF | Suitable for sawing wood, plywood, particleboard, MDF | Indicada para trabajos con aserrar madera, compensados, aglomerados de partículas, MDF
- Embalagem: Blister | Packing: Blister | Embalaje: Blister

Jogo para serra tico tico

Tico-tico saw set | Juego para sierra Tico-tico



DIMENSÕES | SIZE | TAMAÑO (MM)



782169

T301CD, 90 x 3,0 mm, HCS

90

200

25



BLISTER

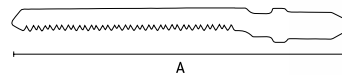

- Aço Carbono | Carbon steel | Acero carbono
- Encaixe bosch | Bosch fitting | Encaje bosch
- Indicada para trabalhos com serrar madeira, compensados, aglomerados de partículas, MDF | Suitable for sawing wood, plywood, particleboard, MDF | Indicada para trabajos con aserrar madera, compensados, aglomerados de partículas, MDF
- Embalagem: Blister | Packing: Blister | Embalaje: Blister

Jogo de Lâminas de Serra para Madeira

Jigsaw Blade Set for Wood | Juego Láminas de Sierra para Madera



DIMENSÕES | SIZE | TAMAÑO (MM)



782509

T-SET3 (T101BR, T111C, T144D, T244D, T119B0)

8,0

72

100

25

782519

T-SET4 (T127D, T111C, T144D, T118A, T119B0)

8,0

72

100

25



BLISTER

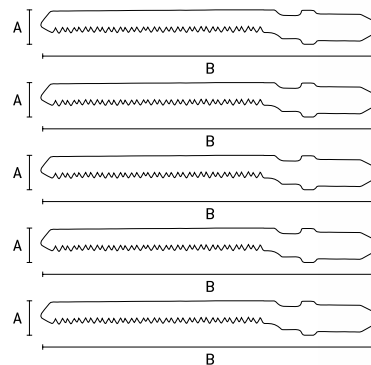

Tesoura para chapas corte reto

Shears for plates | Tijeras para chapas



NOVO	Código	DIMENSÕES SIZE TAMAÑO (MM)		Cód. Produto	Quant. Min.	
		A	B			
	7831255	8" (200 mm)	50	200	100	5
	7831355	10" (250 mm)	70	250	48	6
	7831455	12" (300 mm)	80	300	36	6

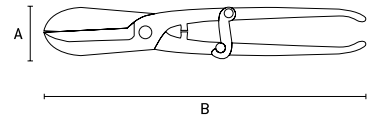

- Indicada para corte reto em chapas macias de até 1,0 mm | Suitable for straight cutting on soft sheets up to 1.0 mm | Indicada para corte recto en chapas suaves de hasta 1,0 mm
- Cabo de metal | Metal cable | Mango de metal
- Lâminas forjadas | Forged Blades | Láminas forjadas

Tesoura reta para chapas corte reto

Straight sheet shears | Tijeras rectas para chapas



NOVO	Código	DIMENSÕES SIZE TAMAÑO (MM)		Cód. Produto	Quant. Min.	
		A	B			
	783309	10" (250 mm)	95	250	48	6

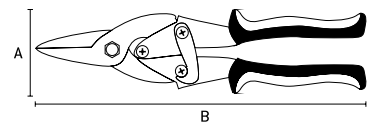

- Cabo de dois componentes | Two-component cable | Mango de dos componentes
- Corte reto em chapas de até 1,0 mm de espessura | Straight cut in sheets up to 1.0 mm thick | Corte recto en chapas de hasta 1,0 mm de espesor

Tesoura direita para chapas corte à direita

Right Scissor for Sheets | Tijera derecha para chapas



NOVO	Código	DIMENSÕES SIZE TAMAÑO (MM)		Cód. Produto	Quant. Min.	
		A	B			
	783329	10" (250 mm)	95	250	48	6

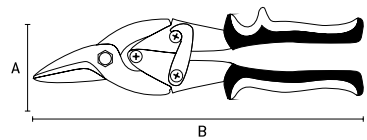

- Cabo de dois componentes | Two-component cable | Mango de dos componentes
- Corte a direita em chapas de até 1,0 mm de espessura | Cut to the right in sheets up to 1.0 mm thick | Corte a la derecha en chapas de hasta 1,0 mm de espesor
- Embalagem: Blister | Packing: Blister | Embalaje: Blister

Tesoura esquerda para chapas corte à esquerda

Left-handed scissors for plates | Tijera izquierda para chapas



NOVO	Código	DIMENSÕES SIZE TAMAÑO (MM)		Cód. Produto	Quant. Min.	
		A	B			
	783349	10" (250 mm)	95	250	48	6

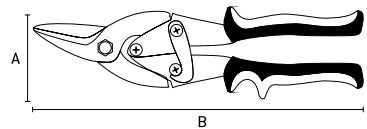

- Cabo de dois componentes | Two-component cable | Mango de dos componentes
- Corte a esquerda em chapas de até 1,0 mm de espessura | Cut to the left in sheets up to 1.0 mm thick | Corte a la izquierda en chapas de hasta 1,0 mm de espesor

Arco de serra
Saw arch | Arco de sierra



7754355	8"-12"	DIMENSÕES SIZE TAMAÑO (MM)		48	12
		A	B		

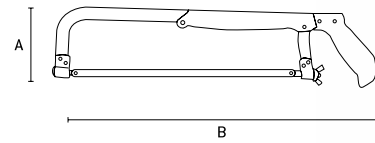

- Estrutura metálica | Metal structure | Estructura metálica
- Regulável de 8" a 12" | Adjustable from 8" to 12" | Regulable de 8" a 12"
- Acompanha : lâmina de serra de aço carbono | Comes with: carbon steel saw blade | Acompaña: lâmina de serra de acero al carbono

Mini arco de serra de metal
Mini sawing bow | Mini arco de sierra



7756059	10"	DIMENSÕES SIZE TAMAÑO (MM)		120	10
		A	B		

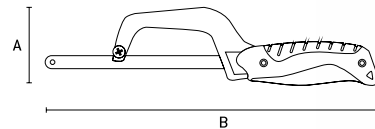

- Estrutura ergonômica em alumínio fundido | Ergonomic structure in cast aluminum | Estructura ergonómica en aluminio fundido
- Podem ser utilizadas lâminas quebradas desde que se tenha pelo menos 90 mm (3 1/2" para encaixe) | Pueden utilizarse cuchillas rotas siempre que se tenga al menos 90 mm (3 1/2" para encaje) | Pueden utilizarse cuchillas rotas siempre que se tenga al menos 90 mm (3 1/2" para encaje)
- Parafuso para travar a lâmina | Screw to lock blade | Tornillo para bloquear la cuchilla
- Cabo com dois componentes emborrachado | Rubberized two component cable | Mango con dos componentes de goma
- Acompanha: lâmina de serra de aço carbono | Comes with: carbon steel saw blade | Acompaña: lâmina de serra de acero al carbono
- Embalagem: Blister | Packing: Blister | Embalaje: Blister

Arco de serra
Saw arch | Arco de sierra



7757655	10"-12"	DIMENSÕES SIZE TAMAÑO (MM)		60	10
		A	B		

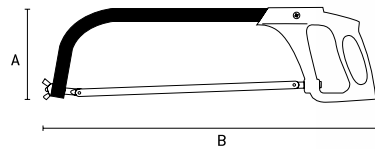

- Estrutura de aço tubular | Metal structure | Estructura metálica
- Cabo plástico ABS de alta resistência | Metal structure | Estructura metálica
- Regulável de 10" a 12" | Adjustable from 10" to 12" | Regulable de 10" a 12"
- Acompanha : lâmina de serra de aço carbono | Comes with: carbon steel saw blade | Acompaña: lâmina de serra de acero al carbono

Arco de serra
Sawing bow | Arco de sierra



775939	12"	DIMENSÕES SIZE TAMAÑO (MM)		24	0
		A	B		

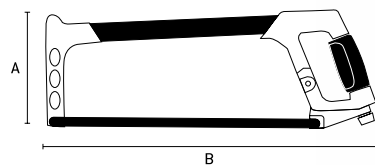

- Lâmina pode ser posicionada à 55° ou 90° | Blade can be positioned at 55° or 90° | La hoja puede colocarse a 55° o 90°
- Cabo ergonômico emborrachado | Rubberized ergonomic handle | Mango ergonómico emborrachado
- Permite armazenar lâminas sobressalentes na base | Store spare blades in base | Permite almacenar cuchillas de repuesto en la base
- Parafuso tensionador | Tensioning screw | Tornillos tensores
- Acompanha: lâmina bimetálica | Comes with: bimetal blade | Acompaña: lâmina bimetálica

Tesoura corta vergalhões

Scissors cuts rebar | Tijera corta barras

HRC
58-60



Código	Tamanho (polegadas)	DIMENSÕES SIZE TAMAÑO (MM)		Quant. Min.
		A	B	
785259	12"	110	300	30
785309	14"	115	350	30
785359	18"	135	450	20
785409	24"	155	600	10
785459	30"	170	750	5
785559	36"	185	900	5
785609	42"	233	1050	3
785659	48"	230	1200	3

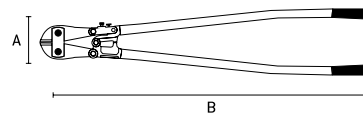

- Aço carbono | Carbon steel | Acero carbono
- Para cortar vergalhões/ ferro para construção | To cut rebar / iron for construction | Para cortar barras de acero / hierro para la construcción
- Cabo vermelho com empunhadura plástica preta | Red metal cable with black plastic grip | Mango de metal rojo con empuñadura plástica negra
- Embalagem: Caixa | Packing: Box | Embalaje: Caja

Cortador de tubos de PVC

PVC pipe cutter | Cortador de tubos de PVC



Código	Tubo (mm)	DIMENSÕES SIZE TAMAÑO (MM)		Quant. Min.
		A	B	
7841059	d42mm	120	255	48
784129	d42mm	120	290	48

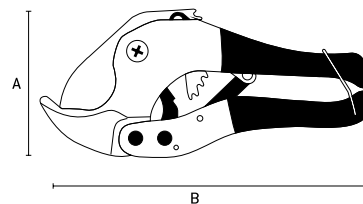

- Sistema de catraca | Ratchet system | Sistema de trinquete
- Para tubos de PVC de até 42 mm | For PVC pipes up to 42 mm | Para tubos de PVC de hasta 42 mm
- Corpo metálico e lâmina de aço | Metal body and steel blade | Cuerpo metálico y lámina de acero
- Não deixa rebarba | Do not let burr | No deja rebarba
- Embalagem: Blister | Packing: Blister | Embalaje: Blister

Mini cortador de tubos

Mini tube cutter | Mini cortador de tubos



Código	Tubo (polegadas)	DIMENSÕES SIZE TAMAÑO (MM)		Quant. Min.
		A	B	
787209	1/8" a 1.3/3.2" (3 a 28 mm)	92	180	50

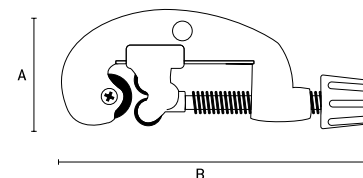

- Indicado para cortar tubos de cobre, alumínio e latão | Suitable for cutting copper, aluminum and brass tubes | Indicado para cortar tubos de cobre, aluminio y latón
- Corpo de alumínio injetado | Injected aluminum body | Cuerpo de aluminio inyectado
- Pintura eletrostática | Electrostatic painting | Pintura electrostática
- Cilindros polidos para fácil rotação | Polished cylinders for easy rotation | Cilindros pulidos para una fácil rotación
- Escareador de tubos embutido na lateral | Built-in tube reamer | Extractor de tubos incrustado en el lateral
- Embalagem: Blister | Packing: Blister | Embalaje: Blister

Canivete

Switchblade | Cortaplumas



BLISTER



7899855

DIMENSÕES | SIZE | TAMAÑO (MM)

A

B



120



10

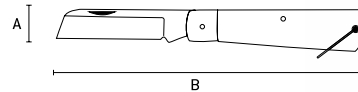

- Lâmina em aço inox, reta | Metal cable | Mango de metal
- Cabo de madeira | Forged Blades | Láminas forjadas
- Embalagem: Blister | Forged Blades | Láminas forjadas

Afiador de facas

Knife sharpener | Afilador de cuchillos



BLISTER



791059



Universal

DIMENSÕES | SIZE | TAMAÑO (MM)

A

B



72



12

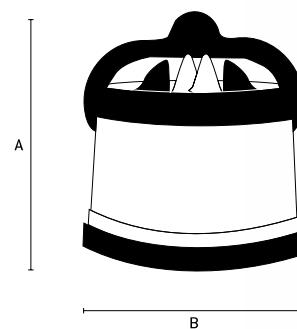

- Corpo Plástico | Plastic Body | Cuerpo Plástico
- Ventosa para fixação | Suction cup for fixing Ventosa para fijación
- 2 pastilhas de metal duro (Wídea) sobrepostas em "V" | 2 carbide inserts (Wídea) superimposed on "V" | 2 pastillas de metal duro (Wídea) sobrepuestas en "V"
- Embalagem: Blister | Packing: Blister | Embalaje: Blister

Afiador de facas

Knife sharpener | Afilador de cuchillos



BLISTER



791009



Universal

DIMENSÕES | SIZE | TAMAÑO (MM)

A

B



72



12

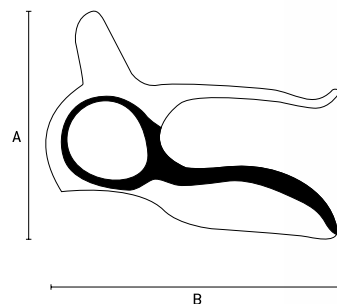

- Corpo Plástico | Plastic Body | Cuerpo Plástico
- Ventosa para fixação | Suction cup for fixing | Ventosa para fijación
- 2 pastilhas de metal duro (Wídea) sobrepostas em "V" | 2 carbide inserts (Wídea) superimposed on "V" | 2 pastillas de metal duro (Wídea) sobrepuestas en "V"
- Embalagem: Blister | Packing: Blister | Embalaje: Blister

Raspadores de rejunte

Grout Scrapers | Rascadores de rejunte

AUTO
SERVIÇO



795459	DIMENSÕES SIZE TAMAÑO (MM)		100	10
	A	B		

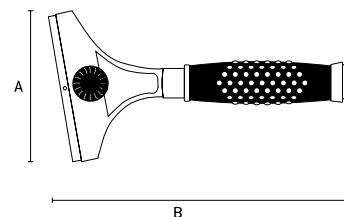

- Universal | Universal | Universal
- Cabo de metal emborrachado | Rubberized metal cable | Mango de metal emborrachado
- Lâmina Fixa | Fixed Blade | Lámina fija
- Embalagem: Blister | Packing: Blister | Embalaje: Blister

Raspadores de rejunte

Grout Scrapers | Rascadores de rejunte

BLISTER



795609	DIMENSÕES SIZE TAMAÑO (MM)		100	10
	A	B		

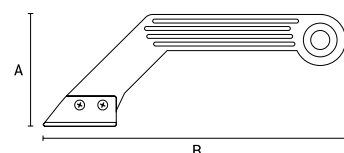

- Para remoção de rejunte/ juntas em pisos e paredes | For removal of grout / joints on floors and walls | Para la remoción de rejunte / juntas en pisos y paredes
- Cabo em polipropileno | Cable in polypropylene | Mango de polipropileno
- Pode ser utilizada 1 ou 2 lâminas, dependendo da espessura da junta a ser removida | 1 or 2 blades can be used, depending on the thickness of the joint to be removed | Se puede utilizar 1 ó 2 láminas, dependiendo del grosor de la junta a ser removida
- Lâmina metálica de tungstênio | Tungsten metal blade | Lámina metálica de tungsteno
- Embalagem: Blister | Packing: Blister | Embalaje: Blister



JOGO PARA SERRA TICO TICO

TICO-TICO SAW SET | JUEGO PARA SIERRA TICO-TICO



AÇO CARBONO
Carbon steel
Acero carbono

ENCAIXE BOSCH
Bosch fitting
Encaje bosch

PARA TRABALHOS COM MADEIRA ou METAL
For works with wood or metal
Para trabajos con madera o metal

ACABAMENTO

FINISHING | ACABADO



FERRAMENTAS DE ACABAMENTO

Finishing's Tools Herramientas de Acabado

As ferramentas de construção e acabamento MTX. Proporcionam ao profissional ou consumidor final um produto de extrema eficiência para o trabalho a ser desenvolvido. Utilizando matérias primas de qualidade as ferramentas tem um ótimo desempenho e proporcionam um excelente resultado.

MTX construction and finishing tools. They provide the professional or final consumer an extremely efficient product for the work to be developed. Using quality raw materials the tools have a great performance and provide an excellent result.

Como herramientas de construcción y acabado MTX. Proporcionar al profesional o Consumidor final un producto de extrema eficacia para el trabajo a ser desarrollado. Cómo utilizar las herramientas como tiene un rendimiento óptimo y proporcionan un excelente resultado.

SIMBOLOGIA



CÓDIGO
CODE



CARACTERÍSTICAS
Technical Features



PESO DA PEÇA
Part Weight
Peso de la Pieza



CAIXA MASTER
Box Master | Caja Máster



Quant. Min.
Quant. Minimum
Cantidad Mínima

Colher de pedreiro RETA

Straight trowel spoon | Cuchara de albañil recta



	Barcode	Height (mm)	Weight (kg)	DIMENSÕES SIZE TAMAÑO (MM)			Box Qty	Min. Qty
				A	B	C		
8621155		7" (175mm)	270g	110	320	90	60	6
8621255		8" (200mm)	325g	155	320	90	60	10

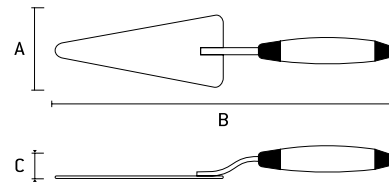

Colher de pedreiro OVAL

OVAL Trowel | Cuchara de albañil OVAL



	Barcode	Height (mm)	Weight (kg)	DIMENSÕES SIZE TAMAÑO (MM)			Box Qty	Min. Qty
				A	B	C		
8620155		7" (175mm)	270g	110	320	90	120	0
8620255		8" (200mm)	325g	155	320	90	120	10
8620355		9" (225mm)	380g	195	320	90	120	10

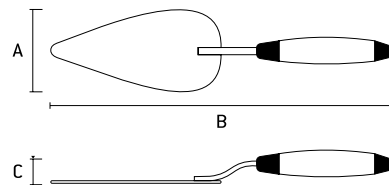

Rolo para pintura de canto

Roll for corner painting | Rodillo para pintura de esquina



	Barcode	Height (mm)	Weight (kg)	DIMENSÕES SIZE TAMAÑO (MM)			Box Qty	Min. Qty
				A	B	C		
806809		altura 12mm	188g	90	440	55	100	0

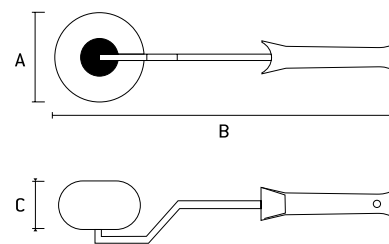

- Fibra sintética | Synthetic fiber | Fibra sintética
- Para utilizar em cantos para acabamento e em lugares de difícil acesso | for use in finishing corners and in hard-to-reach places | para utilizar en esquinas para acabado y en lugares de difícil acceso



Cabo telescópico

Telescopic cable | Mango telescópico



812329



800g



1,5 - 3,0 m

DIMENSÕES | SIZE | TAMANHO (MM)

A

B



Quant. Min.

20

0

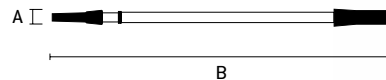

- Para rolos de pintura | For paint rollers | Para los rodillos de pintura
- Metálico | Metallic | Metálico

Lápis de marceneiro / carpinteiro

Woodworking pencils | Lápis de carpintería



8480455



105g

DIMENSÕES | SIZE | TAMANHO (MM)

A

B



Quant. Min.

120

0

8480555

138g

20

250

180

0

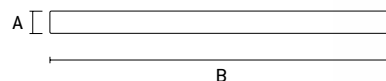

- Grafite em formato retangular | Rectangular graphite | Grafito en formato rectangular
- Indicado para marcações em madeira | Suitable for wood marking | Indicado para marcas de madera
- Embalagem: Caixa | Packing: Box | Embalaje: Caja

Carretel de linha com giz para drywall

Spool line with drywall chalk | Carrete de línea con tiza para drywall



848559



115g-vermelho

DIMENSÕES | SIZE | TAMANHO (MM)

A

B



Quant. Min.

50

25



BLISTER



- Giz vermelho | Red chalk | Giz rojo

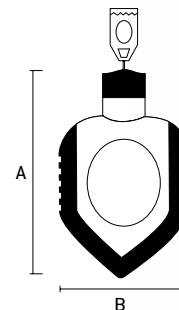

- Carretel plástico com 30 metros de linha de algodão e tubo de 115g com giz | Plastic spool with 30 meters cotton line and 115g tube with chalk | Carrete plástico con 30 metros de línea de algodón y tubo de 115g con tiza
- Embalagem: Blister | Packing: Blister | Embalaje: Blister

Pó de giz

Chalk powder | Polvo de tiza



848579



50g

DIMENSÕES | SIZE | TAMANHO (MM)

A

B



Quant. Min.

200

20

848589

115g

160

50

100

10



- Giz vermelho | Red chalk | Giz rojo

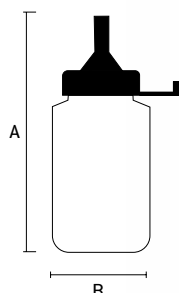

- Indicado para ser utilizado com linha de algodão para marcações em parede | Suitable for use with cotton thread for wall markings | Indicado para ser utilizado con línea de algodón para marcaciones en pared

8

Misturador de tinta

Ink Mixer | Mezclador de tinta



DIMENSÕES | SIZE | TAMAÑO (MM)



	KG	A	B	C	Quant. Min.
848709	229g	60	8	400	20
848749	270g	85	8	400	20
848759	515g	100	8	600	20

AUTO SERVIÇO

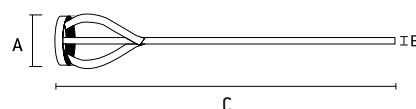

- Indicado para misturar tinta | Suitable for mixing ink | Indicado para mezclar tinta
- Em aço carbono | Carbon steel | En acero al carbono
- Acabamento pintado | Painted finish | Acabado pintado
- Haste Sextavada | Hexagonal stem | Vástago Sextavada
- Embalagem: Blister | Packing: Blister | Embalaje: Blister

Misturador de tinta com encaixe SDS Plus

Ink Mixer | Mezclador de tinta



DIMENSÕES | SIZE | TAMAÑO (MM)



	KG	A	B	C	Quant. Min.
848259	402 g	60	8	400	20
848269	450 g	80	8	450	20
848279	515g	100	8	450	20
848289	625g	120	8	600	20
848819	362g	60	8	400	36
848829	402 g	80	8	400	12
848839	683g	100	8	600	12
848849	642g	120	8	600	12

AUTO SERVIÇO



• 848259 - 848289



• 848819 - 848849

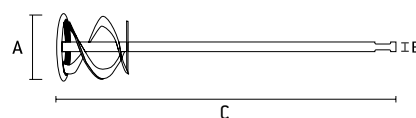
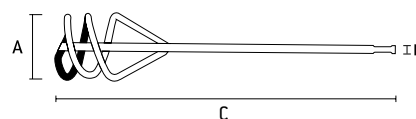

- Indicado para misturar tinta, massa, gesso | Suitable for mixing paint, grease, plaster | Indicado para mezclar tinta, masa, yeso
- Em aço carbono | Carbon steel | En acero al carbono
- Encaixe SDS-PLUS | SDS-PLUS socket | Encaje SDS-PLUS
- Embalagem: Blister | Packing: Blister | Embalaje: Blister

Misturador de massa com haste sextavada

Mass Mixer | Mezclador de masa



DIMENSÕES | SIZE | TAMAÑO (MM)



	KG	A	B	C	Quant. Min.
848419	356g	80	8	530	32
848439	274g	60	8	400	36
848449	288g	80	8	400	12
848459	626g	100	8	600	12
848469	715g	120	8	600	12

AUTO SERVIÇO



• 848419



• 848439 - 848469

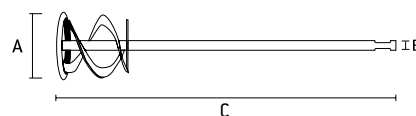
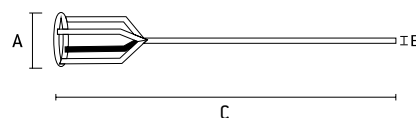

- Indicado para misturar tinta, massa, gesso | Suitable for mixing paint, grease, plaster | Indicado para mezclar tinta, masa, yeso
- Em aço carbono | Carbon steel | En acero al carbono
- Haste Sextavada | Hexagonal stem | Vástago Sextavada
- Embalagem: Blister | Packing: Blister | Embalaje: Blister

Espátula / Betumadeira de aço

Steel spatula | Espátula de acero



NOVO	KG	DIMENSÕES SIZE TAMAÑO (MM)		Quant. Min.		
		A	B			
8520655	1,1/2" (40mm)	39g	40	180	240	10
8520955	2" (50mm)	44g	50	180	240	12
8521255	2,1/4" (60mm)	50g	60	205	240	12
8521555	3,1/8" (80mm)	54g	80	205	240	12
8521855	4" (100mm)	71g	100	205	240	12

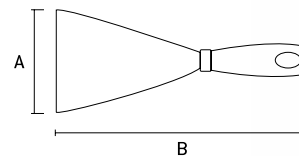

- Lisa | Smooth | Liso
- Cabo de madeira | Wooden handle | Mango de madera

Espátulas cabo de PVC

PVC cable spatulas | Espátulas de mango de PVC



NOVO	KG	DIMENSÕES SIZE TAMAÑO (MM)		Quant. Min.		
		A	B			
855029	8" (200mm)	242g	200	260	60	6
855039	12" (300mm)	317g	300	260	60	6
855049	1,1/2" (40mm)	80g	40	210	240	12
855059	2" (50mm)	83g	50	210	240	12
855069	2,1/4" (60mm)	86g	60	210	240	12
855089	3,1/8" (80mm)	90g	80	210	240	12
855109	4" (100mm)	102g	100	210	240	12
855129	6" (150mm)	108g	120	210	240	12



• 855029 - 855039

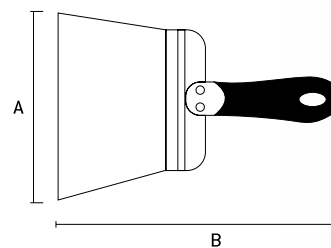

• 855049 - 855129

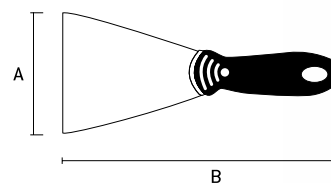

- Cabo anatômico em polipropileno revestido com PVC |

Anatomic cable made of polypropylene coated with PVC | Mango anatómico en polipropileno revestido con PVC

- Lâmina em aço inox especial de alta resistência |

Special high strength stainless steel blade | Lámina de acero inoxidable especial de alta resistencia



Cortador de vidro

Glass cutter | Cortador de cristal



antigo	872235	novo	8722355	KG	25g	DIMENSÕES SIZE TAMAÑO (MM)				Quant. Min.
						A	B	C	480	12

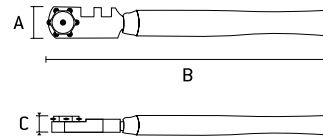

- 6 rodas | 6 wheels | 6 ruedas
- Cabo de madeira | Wooden handle | Mango de madeira
- Embalagem: Caixa | Packing: Box | Embalaje: Caja

Cortador de vidro cabo metálico

Glass cutter | Cortador de cristal



	872649	KG	97g	DIMENSÕES SIZE TAMAÑO (MM)				Quant. Min.
				A	B	C	240	6

AUTO SERVIÇO



- Com reservatório para lubrificante
- Cabo de metal | Metal handle | Mango de metal
- Embalagem: Blister | Packing: Blister | Embalaje: Blister

Alicate punçador para drywall

Pliers punch for drywall | Alicate punzonador para drywall



	879519	225mm	KG	570g	DIMENSÕES SIZE TAMAÑO (MM)			Quant. Min.
					A	B	24	6

AUTO SERVIÇO

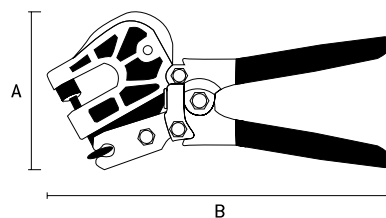

- Cabeçote em alumínio fundido | Die cast aluminum head | Cabezal de aluminio fundido
- Cabo em chapa de aço estampado cromado e plástico | Cable in steel plate, chromed and plastic | Cable en chapa de acero estampado cromado y plastico
- Funcionamento manual | Manual Operation | Funcionamiento manual
- Embalagem: Blister | Packing: Blister | Embalaje: Blister

Prumo de aço

Steel plumbing | Prumo de acero

AUTO
SERVIÇO



848329	200g - cordão 5mt	212g	DIMENSÕES SIZE TAMAÑO (MM)		60	6
			A	B		
848339	300g - cordão 5mt	292g	160	50	60	6

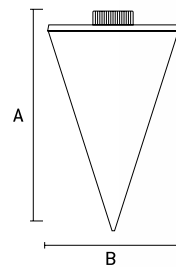

- Corpo de Aço | Body of Steel | Cuerpo de acero
- Cordão de 5m | 5m Cord | Cordon de 5m
- Cordão de Nylon | Nylon cord | Cordon de Nylon
- Embalagem: Blister | Packing: Blister | Embalaje: Blister

Fita adesiva

Scotch tape | Cinta adhesiva



890009	86g	50	DIMENSÕES SIZE TAMAÑO (MM)		100	1
			A	B		
890049	264g	50	20000	90000	36	1*

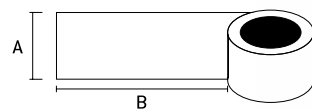

- Fita adesiva de fibra de vidro, para parede | Glass Adhesive Tape for Wall | Cinta adhesiva de cristal, para pared
- Tela de vidro trançada com adesivo acrílico | Glass screen braided with acrylic adhesive | Pantalla de cristal trenzado con adhesivo acrílico
- Indicado para junções em paredes | Suitable for joints in walls | Indicado para uniones en paredes

8

Ventosa Plástica

Plastic Suction Cup | Ventosa Plástica



- 875155
Capacidade máxima de carga: 80 Kg |
Maximum load capacity: 80 kg | Capacidad máxima de carga: 80 Kg
Ventosa Dupla | Double Suction cup | Ventosa Doble



- 875055
Capacidade máxima de carga: 40 Kg |
Maximum load capacity: 40 kg | Capacidad máxima de carga: 40 Kg
Ventosa Simples | Simple Suction cup | Ventosa Simple

- Indicado para elevar/transportar peças planas, lisas, vidros, chapas, espelhos e portas |
Suitable for lifting / transporting flat, flat parts, glass, plates, mirrors and doors |
Indicado para elevar / transportar piezas planas, lisas, vidrios, chapas, espejos y puertas
- Ventosa de borracha com sistema de sucção | Suction cup with suction system | Ventosa de goma con sistema de succión
- Suporte e alça de alumínio | Aluminum bracket and handle | Soporte y mango de aluminio
- Embalagem: Caixa | Packing: Box | Embalaje: Caja

mtx®	KG	DIMENSÕES SIZE TAMAÑO (MM)			Quant. Min.	
		A	B	C		
8751555	667g	130	325	85	12	0
8750555	339g	130	125	105	36	0

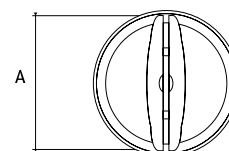
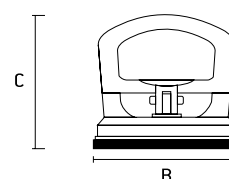
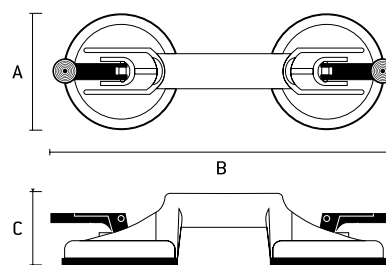

Ventosas de Alumínio (Uso Profissional)

Aluminum Suction Cups (Professional Use) | Ventosas de Aluminio (Uso Profesional)



- 8752059
Ventosa Dupla |
DoubleSuction cup | Ventosa Doble
- Capacidade máxima de carga: 80 Kg |
Maximum load capacity: 80 kg |
Capacidad máxima de carga: 80 Kg



- 8752559
Ventosa Tripla |
Triple Suction cup | Ventosa Triple
- Capacidade máxima de carga: 100 Kg |
Maximum load capacity: 100 kg |
Capacidad máxima de carga: 100 Kg

- Indicado para elevar/transportar peças planas, lisas, vidros, chapas, espelhos e portas |
Suitable for lifting / transporting flat, flat parts, glass, plates, mirrors and doors |
Indicado para elevar / transportar piezas planas, lisas, vidrios, chapas, espejos y puertas
- Ventosa de borracha com sistema de sucção |
Suction cup with suction system | Ventosa de goma con sistema de succión
- Suporte e alça de alumínio | Aluminum bracket and handle | Soporte y mango de aluminio
- Embalagem: Caixa | Packing: Box | Embalaje: Caja

mtx®	KG	DIMENSÕES SIZE TAMAÑO (MM)			Quant. Min.	
		A	B	C		
8752059	882g	125	330	95	12	0
8752559	1317g	240	340	85	6	0

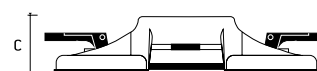
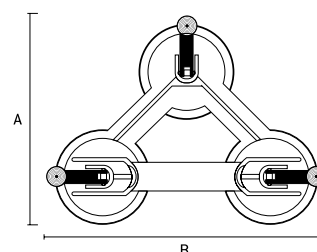
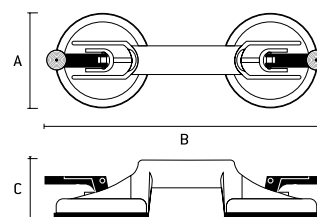

Cortador de cerâmica e azulejos

Ceramic and tile cutter | Cortador de cerâmica y azulejos



Barcode	mm	KG	DIMENSÕES SIZE TAMAÑO (MM)			Quant. Min.	
			A	B	C		
8765155	600mm	3.800g	200	650	200	1	0
8765255	750mm	4.500g	200	800	200	1	0
8765355	900mm	5.100g	200	950	200	1	0

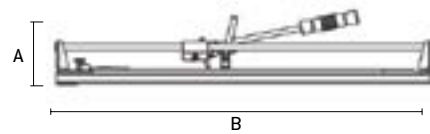

- **Usos:** Profissional | Professional Use | Uso Profesional
- **Projeto:** projetado para cortar uma espessura de até 14mm | Designed to cut a thickness of up to 14mm | Diseñado para cortar un grosor de hasta 14mm
- **Características:** Com régua e separador para ajustar o tamanho e a fixação da peça a ser cortada | With ruler and separator to adjust the size and fixation of the part to be cut | Con regleta y separador para ajustar el tamaño y la fijación de la pieza a ser cortada

Rodel para cortador de pisos

Rodel for floor cutter | Rodillo para cortador de pisos



Barcode	KG	DIMENSÕES SIZE TAMAÑO (MM)			Quant. Min.
		A	B	C	
8766055	50g	10	80	250	0



BLISTER

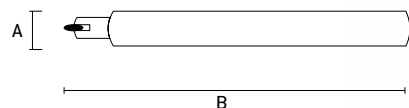

- **Metal:** Duro | Professional Use | Uso Profesional
- **Embalagem:** Blister | Packing: Blister | Embalaje: Blister

Clip nivelador de pisos



Barcode	KG	C	Quant. Min.
881009	300g	12	0



Cortador de cerâmica em círculo

Ceramic cutter in a circle | Cortador de cerâmica en círculo



Barcode	KG	DIMENSÕES SIZE TAMAÑO (MM)			Quant. Min.	
		A	B	C		
882409	290g	125	125	125	20	0

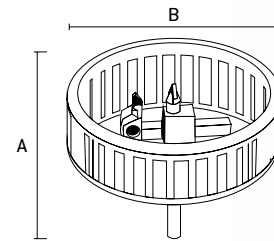

- **Design:** A broca circular com uma grade de plástico de proteção é destinada a fazer furos | The circular drill with a protective plastic grid is designed to drill holes | La broca circular con una rejilla de plástico de protección está destinada a hacer agujeros
- **Design:** O desenho da broca é ajustável ao diâmetro de corte na gama de 20 a 94mm | The drill pattern is adjustable to the cutting diameter in the range of 20 to 94mm | El diseño de la broca es ajustable al diámetro de corte en la gama de 20 a 94 mm
- **Embalagem:** Caixa | Packing: Box | Embalaje: Caja



Aplicador de silicone aberto

Silicone applicator | Aplicador de silicona



		DIMENSÕES SIZE TAMAÑO (MM)			
8861255	292g	A	B	24	0

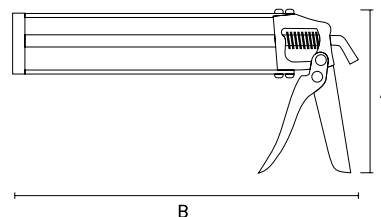

- Metálico | Metallic | Metálico
- Para tubos de até 310g/315ml | For tubes up to 310g / 315ml | Para tubos de hasta 310g / 315ml

Aplicador metálico de silicone semiaberto

Silicone metal applicator | Aplicador metálico de silicona



		DIMENSÕES SIZE TAMAÑO (MM)			
8863655	319g	A	B	36	0

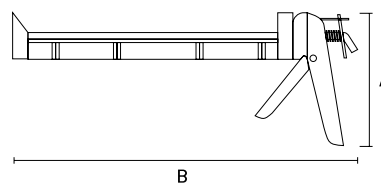

- O desenho da carcaça é reforçado por nervuras transversais | The housing design is reinforced by transverse ribs | El diseño de la carcasa se ve reforzado por nervaduras transversales
- Para tubos de até 310g/315ml | For tubes up to 310g / 315ml | Para tubos de hasta 310g / 315ml

Aplicador de silicone fechado

Silicone applicator | Aplicador de silicona



			DIMENSÕES SIZE TAMAÑO (MM)			
8864755	400mm	600g	A	B	20	0
8864855	750mm	725g	60	550	20	0

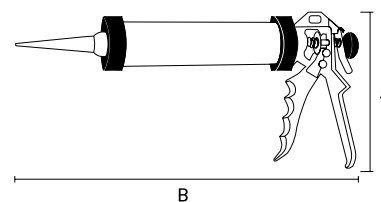

- Metálico | Metallic | Metálico



ACESSÓRIOS PARA FERRAMENTAS

Fittings for Tools
Accesorios para Herramientas

As ferramentas de construção e acabamento MTX. Proporcionam ao profissional ou consumidor final um produto de extrema eficiência para o trabalho a ser desenvolvido. Utilizando matérias primas de qualidade as ferramentas tem um ótimo desempenho e proporcionam um excelente resultado.

MTX construction and finishing tools. They provide the professional or final consumer an extremely efficient product for the work to be developed. Using quality raw materials the tools have a great performance and provide an excellent result.

Como herramientas de construcción y acabado MTX. Proporcionar al profesional o Consumidor final un producto de extrema eficacia para el trabajo a ser desarrollado. Como utilizar las herramientas como tiene un rendimiento óptimo y proporcionan un excelente resultado.

SIMBOLOGIA



CÓDIGO
CODE



CARACTERÍSTICAS
Technical Features



PESO DA PEÇA
Part Weight
Peso de la Pieza



CAIXA MASTER
Box Master | Caja Máster



QUANT. MINÍMA
Quant. Minimum
Cantidad Mínimo

Rodízio giratório sem freio

Fixed caster without brake | Rodamiento fijo sin freno



Código	Descrição	DIMENSÕES SIZE TAMAÑO (MM)			Quant. Min.
		A	Quant.	Quant. Min.	
6871655	5" (125 mm) suporta até 100 kg	125	30	0	
6871755	6.5/16" (160 mm) suporta até 135 kg	160	12	0	
6871855	8" (200 mm) suporta até 165 kg	200	8	0	
6872555	2" (50 mm) suporta até 27 kg	50	170	1	
6872655	4.1/2" suporta até 45 kg	115	80	1	
6872755	5.1/8" suporta até 55 kg	130	40	1	

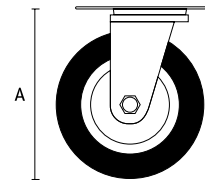

- Roda de borracha preta | Black Rubber Wheel | Rueda de goma negra

Rodízio giratório com freio

Rotary caster with brake | Rueda giratoria con freno



Código	Descrição	DIMENSÕES SIZE TAMAÑO (MM)			Quant. Min.
		A	Quant.	Quant. Min.	
6871955	2" (50 mm) suporta até 25Kg	50	150	0	
6872055	3" (75 mm) suporta até 45Kg	75	80	0	
6872155	4" (100 mm) suporta até 55Kg	100	50	0	

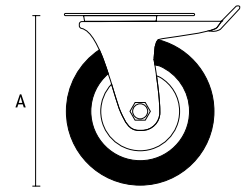

- Roda de borracha cinza | Grey Rubber Wheel | Rueda de goma gris

Rodízio PVC fixo sem freio

Fixed PVC caster without brake | Rodamiento de PVC fijo sin freno



Código	Descrição	DIMENSÕES SIZE TAMAÑO (MM)			Quant. Min.
		A	Quant.	Quant. Min.	
6870755	2" (50 mm) suporta até 25Kg	50	180	0	
6870855	3" (75 mm) suporta até 45Kg	75	80	0	
6870955	4" (100 mm) suporta até 55Kg	100	50	0	

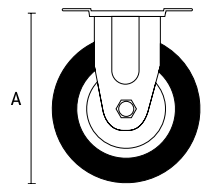

- Roda de borracha cinza e PVC | Gray Rubber Wheel and PVC | Rueda de goma gris y PVC

Rodízio PVC giratório sem freio

Rotary PVC caster with brake | Rueda PVC giratoria con freno



Código	Descrição	DIMENSÕES SIZE TAMAÑO (MM)			Quant. Min.
		A	Quant.	Quant. Min.	
6871355	2" (50 mm) suporta até 25Kg	50	180	0	
6871455	3" (75 mm) suporta até 45Kg	75	80	0	
6871555	4" (100 mm) suporta até 55Kg	100	50	0	

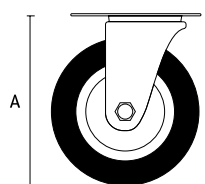

- Roda de borracha cinza e PVC | Gray Rubber Wheel and PVC | Rueda de goma gris y PVC

Rodízio de GEL giratório sem freio

Rotary GEL caster without brake | Rueda de GEL giratoria sin freno



DIMENSÕES SIZE TAMAÑO (MM)	Quant. Min.	Quant. Min.		
		Quant. Min.	Quant. Min.	
6873155	1.3/8" suporta até 20Kg	35	120	0
6873255	2" (50 mm) suporta até 35Kg	50	120	0
6873355	3" (75 mm) suporta até 55Kg	75	60	0

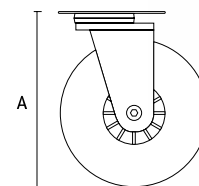

Rodízio de GEL giratório com freio

Rotary GEL caster with brake | Rueda de GEL giratoria con freno



DIMENSÕES SIZE TAMAÑO (MM)	Quant. Min.	Quant. Min.		
		Quant. Min.	Quant. Min.	
6873655	1.3/8" (35 mm) suporta até 20Kg	35	120	0
6873755	2" (50 mm) suporta até 35Kg	50	120	0
6873855	3" (75 mm) suporta até 55Kg	75	60	0

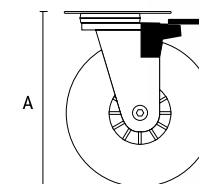

Rodízio fixo de pvc e poliuretano com freio

Fixed pvc and polyurethane brake caster with brake | Rodamiento fijo de pvc y poliuretano con freno



DIMENSÕES SIZE TAMAÑO (MM)	Quant. Min.	Quant. Min.		
		Quant. Min.	Quant. Min.	
6874155	3" (75 mm) suporta até 50Kg	75	40	0
6874255	4" (100 mm) suporta até 50Kg	100	30	0

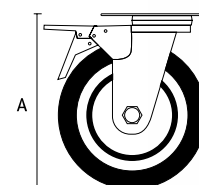

• Roda de PVC e poliuretano vermelho | PVC and red polyurethane wheel | Rueda de PVC y poliuretano rojo

Rodízio Fixo sem freio

Fixed caster without brake | Rodamiento fijo sin freno



DIMENSÕES SIZE TAMAÑO (MM)	Quant. Min.	Quant. Min.		
		Quant. Min.	Quant. Min.	
6871055	5" (125 mm) suporta até 135 kg	125	30	0
6871155	6.5/16" (160 mm) suporta até 150 kg	160	12	0
6871255	8" (200 mm) suporta até 165 kg	200	8	0
6872255	2" (50 mm) suporta até 27 kg	50	170	1
6872355	4.1/2" (115 mm) suporta até 45 kg	115	80	1
6872455	5.1/8" (130 mm) suporta até 55 kg	130	40	1

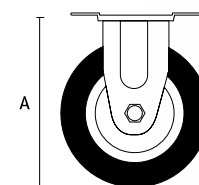

• Roda de borracha preta | Black Rubber Wheel | Rueda de goma negra



Cinto múltiplo porta ferramentas

Multi Tool Belt | Cinturón múltiple porta herramientas



DIMENSÕES | SIZE | TAMAÑO (MM)

A

B



902419

313g

270

280

40

0

AUTO SERVIÇO



Suporte ajustável | Adjustable stand | Soporte ajustable

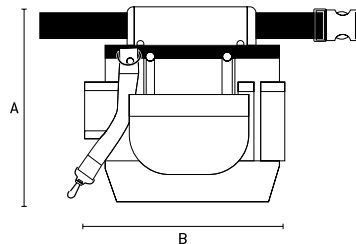

- Confeccionado em lona reforçada | Made of reinforced canvas | Confeccionado en lona reforzada
- Cinto ajustável em nylon com presilha de fixação | Adjustable nylon belt with locking tab | Cinturón ajustable en nylon con fijación de fijación
- Bolsa com 7 bolsos porta ferramentas | Bag with 7 tool holder pockets | Bolsa con 7 bolsillos porta herramientas
- Embalagem: Blister | Packing: Blister | Embalaje: Blister

Bolsa de ferramentas

Tool bag | Bolsa de herramientas



DIMENSÕES | SIZE | TAMAÑO (MM)

A

B



902429

413g

270

290

40

0

AUTO SERVIÇO

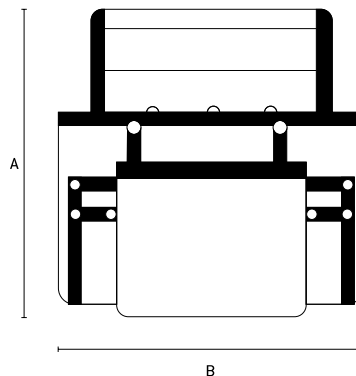

- Confeccionado em lona reforçada | Made of reinforced canvas | Confeccionado en lona reforzada
- Com 8 bolsos e suporte para martelo | With 8 pockets and hammer stand | Con 8 bolsillos y soporte para martillo
- Embalagem: Blister | Packing: Blister | Embalaje: Blister

Porta ferramentas

Toolholder | Puerta de herramientas



DIMENSÕES | SIZE | TAMAÑO (MM)

A

B



902439

322g

335

165

40

0

AUTO SERVIÇO

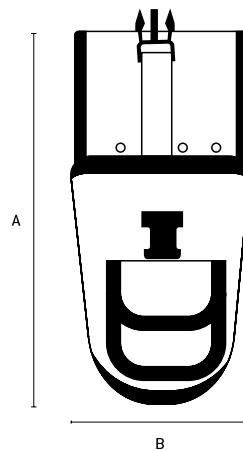

- Confeccionado em lona reforçada | Made of reinforced canvas | Confeccionado en lona reforzada
- Alça passante para cinto | Belt loop strap | Alza pasante para cinturón
- Bolsa com divisórias para furadeira, bits e brocas | Bag with drill, bits and bit dividers | Bolsa con separadores para taladro, bits y brocas
- Não acompanha cinto | Does not include a belt | No acompaña cinturón
- Embalagem: Blister | Packing: Blister | Embalaje: Blister

Cinto porta ferramentas

Tool Belt | Cinturón porta herramientas



902479	810 - 1120mm	125g	DIMENSÕES SIZE TAMAÑO (MM)			72	Quant. Min.
			A	B			
			90	340			0

AUTO
SERVIÇO

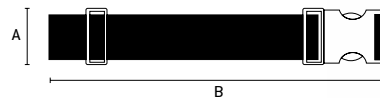

- Confeccionado em lona reforçada | Made of reinforced canvas | Confeccionado en lona reforzada
- Embalagem: Blister | Packing: Blister | Embalaje: Blister

Bolsa e acessórios para ferramentas

Tool bag and accessories | Bolsa y accesorios para herramientas



902569	1235g	DIMENSÕES SIZE TAMAÑO (MM)			16	Quant. Min.
		A	B	C		
		300	460	280		0

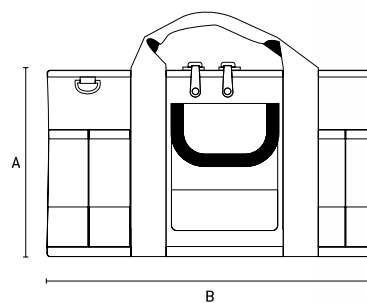

- Confeccionado em lona reforçada | Made of reinforced canvas | Confeccionado en lona reforzada
- Cinto ajustável em nylon com presilha de fixação | Adjustable nylon belt with locking tab | Cinturón ajustable en nylon con presilla de fijación
- Bolsa com 32 bolsos porta ferramentas | Bag with 32 tool holder pockets | Bolsa con 32 bolsillos porta herramientas
- 17 bolsos externos e 15 bolsos internos
- Embalagem: Blister | Packing: Blister | Embalaje: Blister

Bolsa e acessórios para ferramentas

Tool bag and accessories | Bolsa y accesorios para herramientas



902529	1331g	DIMENSÕES SIZE TAMAÑO (MM)			12	Quant. Min.
		A	B	C		
		500	300	280		0

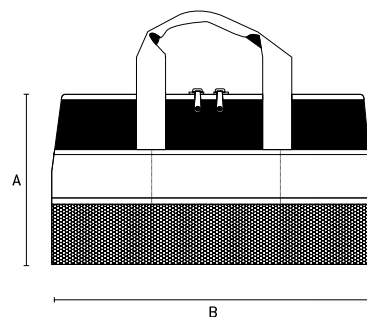

- Confeccionado em lona Made of canvas | Confeccionado en lona
- Alça reforçada de nylon | Reinforced nylon strap | Alza reforzada de nylon
- Bolsa com 18 bolsos porta ferramentas | Bag with 18 tool holder pockets | Bolsa con 18 bolsillos porta herramientas
- 12 bolsos externos e 6 bolsos internos
- Reforço na parte superior e inferior | Reinforced nylon strap | Alza reforzada de nylon
- Zíper extrarreforçado | Reinforced nylon strap | Alza reforzada de nylon
- Embalagem: Blister | Packing: Blister | Embalaje: Blister



9

Colete porta ferramentas

Tool holder vest | Chaleco porta herramientas

AUTO
SERVIÇO



902469



608g

DIMENSÕES | SIZE | TAMAÑO (MM)

A

B



12



Quant. Min.
0

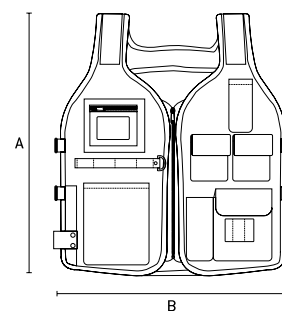

- Confeccionado em lona reforçada com forro | Made of canvas reinforced with lining | Confeccionado en lona reforzada con forro
- Zíper reforçado e ajuste lateral de tamanho | Reinforced zipper and side size adjustment | Zíper reforzado y ajuste lateral de tamaño
- Embalagem: Caixa | Packing: Box | Embalaje: Caja

Maçarico

Blowtorch | Soplete



BLISTER



914249



222g

DIMENSÕES | SIZE | TAMAÑO (MM)

A

B



72



Quant. Min.
12

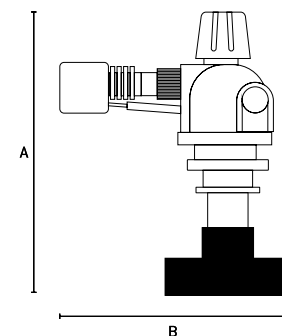

- Bico padrão | Standard nozzle | Boquilla estándar
- Acendimento automático | Automatic ignition | Encendido automático
- Embalagem: Blister | Packing: Blister | Embalaje: Blister

Maçarico

Blowtorch | Soplete



BLISTER



914269



396g

DIMENSÕES | SIZE | TAMAÑO (MM)

A

B



48



Quant. Min.
8

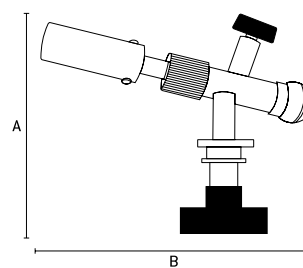

- Bico padrão | Standard nozzle | Boquilla estándar
- Bico estendido, metal | Extended nozzle, metal | Boquilla extendida, metal
- Acendimento automático | Automatic ignition | Encendido automático
- Embalagem: Blister | Packing: Blister | Embalaje: Blister

Maçarico

Blowtorch | Soplete



BLISTER



914279



306g

DIMENSÕES | SIZE | TAMAÑO (MM)

A

B



72



Quant. Min.
12

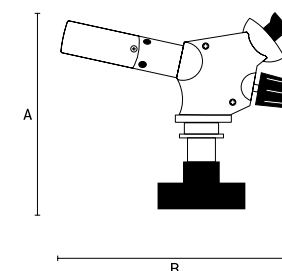

- Bico padrão | Standard nozzle | Boquilla estándar
- Bico estendido, metal | Extended nozzle, metal | Boquilla extendida, metal
- Acendimento automático | Automatic ignition | Encendido automático
- Embalagem: Blister | Packing: Blister | Embalaje: Blister

Afiador de brocas

Sharpening drills | Afilador de brocas



NOVO	3,5 a 10mm	435g	DIMENSÕES SIZE TAMANHO (MM)		20	Quant. Min.
			A	B		
9123055			200	223		0



BLISTER

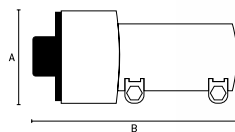

Para ser utilizado com furadeira |
To be used with a drill |
Para ser utilizado con taladro

- Indicado para brocas com um diâmetro de 43mm de área de corte |
Indicated for drills with a diameter of 43mm of cut area |
Indicado para brocas con un diámetro de 43mm de área de corte
- Embalagem: Blister | Packing: Blister | Embalaje: Blister

Porta eletrodo

Electrode holder | Puerta electrodo



9145355	300 amperes amps amperios	252g	DIMENSÕES SIZE TAMANHO (MM)		50	0
			A	B		
9145555	500 amperes amps amperios	308g	85	240	50	0

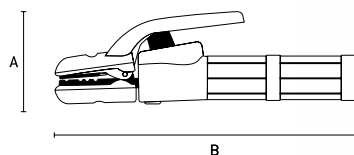

Suporte para furadeira

Drill stand | Soporte para taladro



9340555	2700g	DIMENSÕES SIZE TAMANHO (MM)		10	0
		A	B		
		430	215		



Suporte ajustável
Adjustable stand
Soporte ajustable



Morça com ajuste
Vise with adjustment
Morsa con ajuste



Base Ajustável
Adjustable Base
Base ajustable

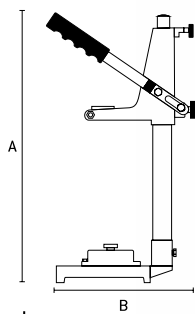

Trava Cabo de Aço

Locks Steel Cable | Bloqueos Cable de Acero



918149	146g	DIMENSÕES SIZE TAMAÑO (MM)		120	1
		A	B		
918169	185g	8	1200	60	1

AUTO SERVIÇO

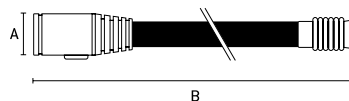

- Cabo de aço flexível em uma capa plástica protetora | Flexible steel cable in a protective plastic cover | Cable de acero flexible en una capa plástica protectora
- Mecanismo secreto (larvas) em latão | Secret mechanism (larvae) in brass | Mecanismo secreto (larvas) en latón
- Bloqueio automático | Automatic blocking | Bloqueo automático
- Inclui duas chaves de aço | Includes two steel wrenches | Incluye dos llaves de acero

Trava Cabo de Aço

Locks Steel Cable | Bloqueos Cable de Acero



918179	263g	DIMENSÕES SIZE TAMAÑO (MM)		60	0
		A	B		
		12	1200		

AUTO SERVIÇO

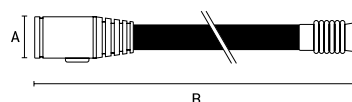

- Cabo de aço flexível em uma capa plástica protetora | Flexible steel cable in a protective plastic cover | Cable de acero flexible en una capa plástica protectora
- Fechadura de combinação | Combination lock | Cerradura de combinación

Trava Cabo de Aço

Locks Steel Cable | Bloqueos Cable de Acero



918189	273g	DIMENSÕES SIZE TAMAÑO (MM)		48	1
		A	B		
		10	950		

AUTO SERVIÇO

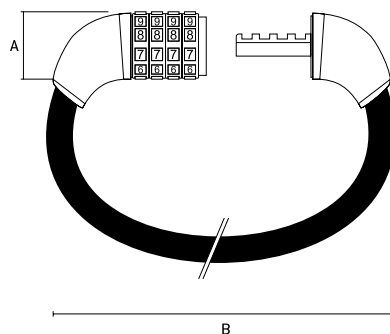

- Cabo de aço flexível em uma capa plástica protetora | Flexible steel cable in a protective plastic cover | Cable de acero flexible en una capa plástica protectora
- Fechadura de combinação | Combination lock | Cerradura de combinación

INFORMAÇÕES

Information | Información



INFORMAÇÕES GERAIS

General information
Informaciones generales

- **ÍNDICE ALFABÉTICO**
ALPHABETICAL INDEX | ÍNDICE ALFABÉTICO
- **TABELAS DE CONVERSÕES**
CONVERSION TABLES | TABLAS DE CONVERSIONES
- **SIMBOLOGIA TÉCNICA**
TECHNICAL SYMBOLS | SIMBOLOGÍA TÉCNICA

Fotos dos produtos | Product Photos | Fotos de los productos

- **Algumas fotos ou imagens contidas neste catálogo são meramente ilustrativas.**

Some photos or images contained in this catalog are merely illustrative.

Algunas fotos o imágenes contenidas en este catálogo son meramente ilustrativas.

Alterações / modificações de produtos | Product changes / modifications | Cambios / modificaciones de productos

- **A Toolsworld reserva-se no direito de alterar qualquer um dos itens contidos neste catálogo, com o objetivo de melhorá-los ou sempre que existam razões técnicas ou comerciais para isto. Qualquer alteração que vier a ser efetivada está isenta de aviso prévio e não obriga à modificação das unidades já vendidas.**

Toolsworld reserves the right to change any of the items contained in this catalog for the purpose of improving them or whenever there are technical or commercial reasons for doing so.

Any changes that may be made are exempt from prior notice and do not require the modification of units already sold.

Toolsworld se reserva el derecho de cambiar cualquiera de los elementos contenidos en este catálogo, con el fin de mejorarlos o siempre que existan razones técnicas o comerciales para ello.

Cualquier alteración que se esté realizando está exenta de aviso previo y no obliga a la modificación de las unidades ya vendidas.

Cancelamento ou retirada de produção | Cancellation or withdrawal of production | Cancelación o retirada de producción

- **A Toolsworld reserva-se no direito de retirar de produção ou anular a comercialização de qualquer item presente neste catálogo.**

Toolsworld reserves the right to withdraw from production or void the marketing of any item in this catalog.

Toolsworld se reserva el derecho de retirar de producción o anular la comercialización de cualquier artículo presente en este catálogo.

Medidas e Pesos | Measures and Weights | Medidas y Pesos

- **Os valores relativos a pesos e medidas contidos neste catálogo são sujeitos a alterações.**

The values for weights and measures contained in this catalog are subject to change.

Los valores relativos a pesos y medidas contenidos en este catálogo están sujetos a cambios.



ÍNDICE ALFABÉTICO

ALPHABETICAL INDEX | INDICE ALFABÉTICO

A



PRODUTOS	TRADUÇÃO	MARCA	PAG.
Abraçadeira	Clamp Abrazadera	PALISAD	149
Abraçadeira rosca sem fim	Endless threaded clamp Abrazadera rosca sin fin	SPARTA	123
Adaptador	Universal joint Junta universal	STELS	108
Adaptador Flexível	Flexible Adapter Adaptador Flexible	GROSS	106
Adaptador para boina	Adapter for beret Adaptador para boina	MTX	174
Adaptador para mandril	Adapter for mandrel Adaptador para mandril	MTX	160
Afiador de brocas	Sharpening drills Afilador de brocas	SPARTA	215
Afiador de facas	Knife sharpener Afilador de cuchillos	MTX	197
Afiador de facas	Knife sharpener Afilador de cuchillos	MTX	197
Alicate Bico Meia-Cana Curvo Mini	Pliers Beak Half-Cane Curved Mini Pinza Punta Media-Canã Curvo Mini	SPARTA	52
Alicate Bico Meia-Cana Curvo Níckel	Pliers Beak Half-Cane Curved Nickel Pinza Punta Media-Canã Curvo Níckel	MTX	49
Alicate Bico Meia-Cana Reto	Pliers Beak Half-Cane Straight Pinza Punta Media-Canã Reto	GROSS	48
Alicate Bico Meia-Cana Reto Black Níckel	Pliers Beak Half-Cane Straight Black Nickel Pinza Punta Media-Canã Reto Black Nickel	MTX	50
Alicate Bico Meia-Cana Reto Mini	Pliers Beak Half-Cane Straight Mini Pinza Punta Media-Canã Reto Mini	SPARTA	52
Alicate Bico Meia-Cana Reto Níckel	Pliers Beak Half-Cane Straight Nickel Pinza Punta Media-Canã Reto Níckel	MTX	49
Alicate Bico Meia-Cana Reto VDE	Pliers Beak Half-Cane Straight VDE Pinza Punta Media-Canã Reto VDE	MTX	51
Alicate bomba d'agua	Tile Pincers Tenaza para azulejo	SPARTA	55
Alicate bomba d'agua	Tile Pincers Tenaza para azulejo	MTX	55
Alicate Corte Diagonal (150mm)	Diagonal Cutting Pliers Pinza Corte Diagonal	GROSS	48
Alicate Corte Diagonal Black Níckel	Diagonal Cutting Pliers Black Nickel Pinza Corte Diagonal Black Níckel	MTX	50
Alicate Corte Diagonal Mini	Diagonal Cutting Pliers Mini Pinza Corte Diagonal Mini	SPARTA	52
Alicate Corte Diagonal Níckel	Diagonal Cutting Pliers Nickel Pinza Corte Diagonal Níckel	MTX	49
Alicate Corte Diagonal VDE	Diagonal Cutting Pliers VDE Pinza Corte Diagonal VDE	MTX	51
"Alicate Crimpador Catracado Para Cabos RJ11, RJ12 e RJ45"	"Caught catching cranket for RJ11, RJ12 and RJ45 cables Alicate crimpador catracado para cables RJ11, RJ12 y RJ45"	GROSS	58
Alicate de Pressão Bico Chato	Flat Tip Pliers Alicate de Presión Boquilla Chato	MTX	60
Alicate de Pressão Mordente Curvo	Curved Cheek Pressure Pliers Alicate de Presión Mordente Curvo	MTX	59
Alicate de Pressão Mordente Curvo Reto	Curved Cheek Pressure Pliers Alicate de Presión Mordente Curvo	MTX	59
Alicate de Pressão Mordente Longo	Long Cheek Pressure Pliers Alicate de Presión Mordente Largo	MTX	59
Alicate de Pressão Mordente Reto	Pressure Munching Pliers Alicate de Presión Mordente Recto	MTX	59
Alicate de Pressão Mordente Tipo C	Type U Munch Pressure Pliers Alicate de presión Mordente Tipo U	MTX	60
Alicate de Pressão Tipo Corrente	Current Type Pressure Pliers Alicate de presión tipo corriente	MTX	60
Alicate externo Bico Curvo	External pliers Beak Curved Pinza externa Punta curva	SPARTA	54
Alicate externo Bico Reto	External pliers Beak Reto Pinza externa Punta Reto	SPARTA	54
Alicate interno Bico Curvo	Internal pliers Beak Curved Pinza interna Punta curva	SPARTA	54
Alicate interno Bico Reto	Internal pliers Beak Reto Pinza interna Punta Reto	SPARTA	54
Alicate punçador para drywall	Pliers punch for drywall Alicate punzonador para drywall	MTX	204
Alicate Universal Mini	Universal pliers Mini Alicate Universal Mini	SPARTA	52
Alicate Universal Combinada(210mm)	Universal Combination Pliers Alicate Universal Combinado	GROSS	48
Alicate Universal Níckel	Universal pliers Nickel Alicate Universal Nickel	MTX	49
Alicate Universal Níckel	Universal pliers Nickel Alicate Universal Nickel	MTX	50
Alicate Universal VDE	Universal pliers Nickel Alicate Universal Nickel	MTX	51
Almotolia metálica	Metal almotolia Almotolia metálica	SPARTA	122
Ancinho / Rastelo	Creep / Rake Rastrillo / Rizo	PALISAD	135
Ancinho / Rastelo	Creep / Rake Rastrillo / Rizo	PALISAD	135
Ancinho / Rastelo	Creep / Rake Rastrillo / Rizo	PALISAD	135
Ancinho / Rastelo	Creep / Rake Rastrillo / Rizo	PALISAD	138
Ancinho / Rastelo	Creep / Rake Rastrillo / Rizo	PALISAD	139



PRODUTOS	TRADUÇÃO	MARCA	PAG.
Ancinho / Rastelo	Creep / Rake Rastrillo / Rizo	PALISAD	140
Aplicador de silicone	Silicone applicator Aplicador de silicona	SPARTA	208
Aplicador de silicone	Silicone applicator Aplicador de silicona	SPARTA	208
Aplicador metálico de silicone	Silicone metal applicator Aplicador metálico de silicona	SPARTA	208
Arco de serra	Saw arch Arco de sierra	SPARTA	195
Arco de serra	Saw arch Arco de sierra	SPARTA	195
Arco de serra	Saw arch Arco de sierra	MTX	195
Arrancador de Ervas Daninhas	Pluck herbs Arrancador de hierbas	PALISAD	139

B



PRODUTOS	TRADUÇÃO	MARCA	PAG.
Balde	Bucket cubo	PALISAD	141
Bits / Ponteira - 1/4"	Bits / Tips - 1/4" Bits / Ponteira - 1/4"	MTX	28
Bolsa de ferramentas	Tool bag Bolsa de herramientas	MTX	212
Bolsa e acessórios para ferramentas	Tool bag and accessories Bolsa y accesorios para herramientas	MTX	213
Bolsa e acessórios para ferramentas	Tool bag and accessories Bolsa y accesorios para herramientas	MTX	213
Bolsa térmica de poliéster	Polyester thermal bag Bolsa térmica de poliéster	PALISAD	152
Bordas para jardim	Garden borders Bordes para jardín	PALISAD	141
Bordas para jardim	Garden borders Bordes para jardín	PALISAD	141
Broca bailarina	Drill for wood Broca para madeira	MTX	156
Broca chata para madeira	Flat boring drill Broca plana para madeira	MTX	155
Broca de concreto SDS Plus	Concrete drill bit Broca de concreto	MTX	160
Broca Escalonada HSS	HSS Stepper Drill Broca Escalada HSS	MTX	166
Broca espiral para madeira	Spiral drill for wood Taladro espiral para madeira	MTX	154
Broca Foster para madeira	Foster Wood Drill Broca Foster para madeira	MTX	155
Broca guia para serra copo	Guide saw drill bit Broca guia para Sierra de agujero	MTX	158
Broca HSS Industrial	HSS Industry Drill Broca HSS Industrial	MTX	163
Broca HSS Professional	HSS Professional Drill Broca HSS Professional	MTX	164
Broca HSS Profissional	HSS Professional Drill Broca HSS Professional	MTX	162
Broca HSS Profissional	HSS Professional Drill Broca HSS Professional	MTX	163
Broca HSS Standard	HSS Standard Drill Broca HSS Estándar	MTX	163
Broca HSS Standard/ Aço rápido polido	"HSS Standard Drill / Polished Rapid Steel Broca HSS Estándar / Acero rápido pulido"	MTX	162
Broca para Concreto	Concrete drill Broca para concreto	MTX	161
Broca para concreto - Golden Line	Concrete drill - Golden line Taladro para hormigón - Golden Line	MTX	160
Broca para Concreto SDS Max	Concrete drill Broca para concreto	MTX	161
Broca para Concreto SDS Plus	Concrete drill Broca para concreto	MTX	161
Broca para porcelanato	Porcelain drill bit Broca para porcelana	MTX	167

C



PRODUTOS	TRADUÇÃO	MARCA	PAG.
Cabo de força "T"	Power cable "T" Cable de fuerza "T"	MTX	109
Cabo de força "T"	Power cable "T" Cable de fuerza "T"	STELS	109
Cabo de força articulado 1/2" quadrado	Extensions 1/2 "square Extensiones 1/2 "cuadradas	MTX	107
Cabo de transmissão de carga de bateria	Battery charge transmission cable Cable de transmisión de carga de batería	STELS	123
Cabo telescópico	Telescopic cable Mango telescópico	MTX	201
Caixa de bits /Ponteira 50mm	Bit set Box / Tip 50mm Caja de bits / Puntera 50mm	MTX	22
Caixa de bits /Ponteira Multidentada	Bit set Box Multidentate / Tip Caja de bits / Puntera Multidentate	STELS	32
Caixa de bits /Ponteira Multidentada	Bit set Box Multidentate / Tip Caja de bits / Puntera Multidentate	STELS	33

PRODUTOS	TRADUÇÃO	MARCA	PAG.
Caixa de bits /Ponteira Sextavado	Bit set Box Sixth grade / Tip Caja de bits / Puntera hexagonal	STELS	32
Caixa de bits /Ponteira Torx	Bit set Box Torx / Tip Caja de bits / Puntera Torx	STELS	33
Caixa Plástica meia esquadria	Plastic housing half miter Caja Plástica media escuadra	SPARTA	69
Caixa Plástica para serra meia esquadria	Plastic box for half miter saws Caja Plástica para sierra media escuadra	MTX	69
Calibrador de Pneus	Tire Calibrator Calibrador de Neumáticos	STELS	125
Canivete	Switchblade Cortaplumas	SPARTA	197
Canivete para jardim	Garden Knife Cuchillo para jardín	PALISAD	130
Carretel de linha com giz para drywall	Spool line with drywall chalk Carrete de línea con tiza para drywall	MTX	201
Chave de grifo em alumínio	Griffin key aluminum Llave de grifo de aluminio	MTX	40
Chave de grifo Inclinado	Inclined Griffin key Llave de grifo Inclinado	MTX	40
Chave de grifo Modelo Heavy Duty	Pipe wrench Heavy Duty Model Llave de grifo Modelo Heavy Duty	MTX	40
Chave de grifo tipo "S"	Pipe wrench type " S " Clave de grifo tipo " S "	MTX	39
Chave de grifo tipo Stillson	Pipe wrench Type Stillson Llave de grifo tipo Stillson	SPARTA	40
Chave Inglesa cabo emborrachado	Wrench Rubber Cable Llave de cable de cobre	MTX	39
Chave Inglesa Cromada	Chrome Plated Wrench Llave Inglesa Cromada	SPARTA	39
Chave Combinada	Combined key Llave Combinada	STELS	115
Chave Combinada	Combined key Llave Combinada	SPARTA	113
Chave Combinada	Combined key Llave Combinada	STELS	114
Chave Combinada	Combined key Llave Combinada	MTX	115
"Chave Combinada com catraca articulada"	"Combination wrench with articulated ratchet Llave Combinada con trinquete articulado"	MTX	115
Chave Combinada com catraca	Combination wrench with ratchet Llave Combinada con trinquete	MTX	115
Chave de Biela	Connecting rod wrench Llave de Biela	STELS	112
"Chave de bits com alça ergonômica em forma de T"	"Bit key with T-shaped ergonomic handle Llave de bits con mango ergonómico en forma de T"	MTX	30
Chave de bits com catraca reversível	Reversible ratchet bit key Llave de bits con trinquete reversible	SPARTA	29
Chave de bits reversível com dobradiça	Reversible bit key with hinged Llave de bits reversible con bisagra	SPARTA	29
Chave de catraca	Ratchet wrench Llave de trinquete	SPARTA	109
Chave de catraca	Ratchet wrench Llave de trinquete	MTX	109
Chave de catraca	Ratchet wrench Llave de trinquete	MTX	109
Chave de catraca	Ratchet wrench Llave de trinquete	STELS	110
Chave de catraca Teflonada	Teflon Ratchet wrench Llave de trinquete Teflón	STELS	110
Chave de catraca Teflonada	Teflon Ratchet wrench Llave de trinquete Teflón	GROSS	110
Chave de corrente	Power switch Llave de corriente	SPARTA	122
Chave de Fenda Especialista	Screwdriver Destornillador	SPARTA	34
Chave de Fenda/Phillips	Screwdriver / Phillips Destornillador / phillips	SPARTA	30
Chave de impacto rotativo - 7pçs	Rotary impact wrench - 7pcs Llave de impacto rotativo - 7pzs	MTX	31
Chave de Roda	Wheel Wrench Llave de Rueda	MTX	112
Chave de Roda	Wheel Wrench Llave de Rueda	GROSS	112
Chave de Roda em Cruz	Cross Wheel Wrench Llave de Rueda en Cruz	STELS	112
Chave de Roda Montável	Wheel Wrench Llave de Rueda	GROSS	113
Chave de Roda Tipo L	Type L Wheel Wrench Llave de Rueda Tipo L	STELS	112
Chave de Teste	Test Key Clave de prueba	SPARTA	123
Chave Estrela	Star key Clave estrella	STELS	114
Chave Estrela	Star key Clave estrella	SPARTA	113
Chave estrela com catraca	Fixed wrench with ratchet Llave fija con tornillo	MTX	114
Chave Fixa	Fixed key Clave fija	STELS	113
Chave Fixa	Fixed key Clave fija	SPARTA	113
Chave para Mandril	Chuck wrench Llave para Mandril	MTX	45
Chave Phillips Ponta imantada	Phillips head Magnetic tip Llave Phillips Extremidad imantada	MTX	34
"Chave reversível com bits/ponteira/soquetes-16pçs"	"Reversible switch with bits/bushing/sockets-16pcs Llave reversible con bits/puntera/enchufe-16pzs"	MTX	30



PRODUTOS	TRADUÇÃO	MARCA	PAG.
Chave Starter	Starter wrench Llave Starter	STELS	120
Chave suporte para soquetes	Anatomical cable for sockets Cabo anatômico para soquetes	MTX	108
Chave suporte para soquetes	Socket wrench holder Llave de soporte para sockets	STELS	108
Chave Teste 140mm	teste Key 140mm Llave Test 140mm	SPARTA	36
Chave Teste 190mm	teste Key 190mm Llave Test 190mm	SPARTA	36
Chaves Allen Curta fosfatizada	Allen Key Phosphatized Chaves Allen fosfatizado	MTX	15
Chaves Allen Longa Abaulada fosfatizada	Allen Key Long Phosphatized Chaves Allen Larga fosfatizado	MTX	15
Chaves Fenda / Phillips Série Cabo Verde	"Screwdrivers / Key Phillips - Point Series Llaves Destornillador / Phillips - Serie Point"	MTX	35
Chaves Fenda / Phillips Série Point	"Screwdrivers / Key Phillips - Point Series Llaves Destornillador / Phillips - Serie Point"	SPARTA	35
Chaves TORX curta fosfatizada com guia	TORX Key Phosphatized Chaves TORX fosfatizado	MTX	15
Chaves TORX longa fosfatizada com guia	TORX Key Long Phosphatized Chaves TORX Larga fosfatizado	MTX	15
Chaves VDE	VDE Keys Llaves VDE	MTX	34
Cinta para amarração de carga	Load lashing strap Cinta de amarre de carga	STELS	120
Cinta para amarração de carga	Load lashing strap Cinta de amarre de carga	STELS	120
Cinto múltiplo porta ferramentas	Multi Tool Belt Cinturón múltiple porta herramientas	MTX	212
Cinto porta ferramentas	Tool Belt Cinturón porta herramientas	MTX	213
Colete porta ferramentas	Tool holder vest Chaleco porta herramientas	MTX	214
Colher de pedreiro OVAL	OVAL Trowel Cuchara de albañil OVAL	MTX	200
Colher de pedreiro RETA	Straight trowel spoon Cuchara de albañil recta	MTX	200
Cone para plantio	Cone for planting Cono de plantación	PALISAD	142
Conector de mangueira 1/2"	Hose connector Conector de manguera	PALISAD	145
Conector duplo para engate rápido	Double connector for quick coupling Conector doble para enganche rápido	PALISAD	147
Conector fêmea de plástico com bucha 3/4"	"Plastic female connector with bushing Conector hembra de plástico con casquillo"	PALISAD	145
Conector macho	Connector male Conector macho	PALISAD	147
Conector triplo para engate rápido	Triple connector for quick coupling Conector triple para acoplamiento rápido	PALISAD	143
Conector triplo para engate rápido	Triple connector for quick coupling Conector triple para enganche rápido	PALISAD	147
Conectores e adaptadores	Connectors & Adapters Conectores y adaptadores	PALISAD	146
Conectores e adaptadores	Connectors & Adapters Conectores y adaptadores	PALISAD	146
Conjunto de bits com limitador	Bit set with limiter Conjunto de bits con limitador	GROSS	26
Conjunto de bits PH2 70mm	Set of 70mm bits Conjunto de bits 70mm	GROSS	25
Conjunto de bits 25mm - 10 pçs	Set of 25mm bits - 10 pcs Conjunto de bits 25mm - 10 pzs	GROSS	24
Conjunto de bits 25mm - 2 peças	Set of 25mm bits - 2 parts Conjunto de bits 25mm - 2 piezas	GROSS	25
Conjunto de bits 50/ 70/90mm	Bit set 50/70/90mm Conjunto de bits 50/70/90mm	GROSS	25
Conjunto de bits 90mm - 10pçs	Set of 90mm bits 10pcs Conjunto de bits 90mm 10pzs	GROSS	24
Conjuntodebitsadaptadmagnético50mm	Magnetic adapter bit set 50mm Conjunto de bits magnético 50mm	GROSS	26
Conjunto de bits de dois lados PH2 45mm	Double Sided Bits 45mm Conjunto de bits de dos lados 45mm	GROSS	24
Conjunto de Grampos em Forma de G	Set of G-shaped Clips Conjunto de grapas en forma de G	SPARTA	67
Cortador de cerâmica e azulejos	Ceramic and tile cutter Cortador de cerámica y azulejos	MTX	207
Cortador de cerâmica em círculo	Ceramic cutter in a circle Cortador de cerámica en círculo	MTX	207
Cortador de tubos de PVC	PVC pipe cutter Cortador de tubos de PVC	MTX	196
Cortador de vidro	Glass cutter Cortador de cristal	SPARTA	204
Cortador de vidro	Glass cutter Cortador de cristal	MTX	204
Cossinetes	Cossinetes Dies	MTX	184

D



PRODUTOS	TRADUÇÃO	MARCA	PAG.
Desencapador automático	Auto unplug Desengrasador automático	SPARTA	56
Desencapador de fios	Wire stripper Desengrasador de cables	SPARTA	56

PRODUTOS	TRADUÇÃO	MARCA	PAG.
"Desencapador de fios automático com prensa para terminais"	"Automatic wire stripper with press for terminals Desencajador de hilos automático con prensa para terminales"	GROSS	57
Disco de corte Inox/ Metal	Stainless Steel Cutting Disc/Metal Disco de corte Inox/ Metal	GROSS	177
Disco de corte Inox/ Metal	Stainless Steel Cutting Disc/Metal Disco de corte Inox/ Metal	MTX	177
Disco de corte/ Metal	Cutting disc/ Metal Disco de corte/ Metal	MTX	177
Discos de corte diamantados	Diamond Cutting Discs Discos de corte diamantados	SPARTA	171
Discos de corte diamantados	Diamond Cutting Discs Discos de corte diamantados	MTX	171
Discos de corte diamantados	Diamond Cutting Discs Discos de corte diamantados	MTX	171
Discos de corte diamantados	Diamond Cutting Discs Discos de corte diamantados	SPARTA	172
Discos de corte diamantados	Diamond Cutting Discs Discos de corte diamantados	MTX	172
Discos de corte diamantados	Diamond Cutting Discs Discos de corte diamantados	MTX	172
Discos de corte diamantados	Diamond Cutting Discs Discos de corte diamantados	MTX	173
Discos de corte diamantados	Diamond Cutting Discs Discos de corte diamantados	MTX	173
Discos de corte diamantados	Diamond Cutting Discs Discos de corte diamantados	SPARTA	174
Discos de desbaste	Roughing discs Discos de desbaste	MTX	176
Discos de desbaste "FLAP"	Roughing discs " FLAP " Discos de desbaste " FLAP "	GROSS	176
Discos de desbaste "FLAP" zirconio	Roughing discs " FLAP " zirconium Discos de desbaste " FLAP " zirconio	GROSS	176
Discos de lixa	Sanding discs Discos de lija	MTX	175
Discos de lixa com velcro	Sanding discs with velcro Discos de lija con velcro	MTX	175
Discos de serra circular	Circular Saw Blades Discos de sierra circular	MTX	170
Discos de serra circular - Alumínio	Circular Saw Blades Discos de sierra circular	MTX	170

E



PRODUTOS	TRADUÇÃO	MARCA	PAG.
Emenda de mangueira	Hose attachment Enmienda de manguera	PALISAD	146
Engate rápido	Quick coupling Enganche rápido	PALISAD	145
Enxadinha	Small hoe Azada pequeño	PALISAD	137
Escardilho	Spud Escardilho	PALISAD	139
Escova de aço	Steel brush Cepillo de acero	SPARTA	182
Escova Manual	Hand brush Cepillo Manual	MTX	180
Escova manual	Hand brush Cepillo manual	SPARTA	181
Escova pincel	Steel Brush Cepillo Pincel	MTX	181
Escovas circulares	Circular Brushes Cepillos circulares	MTX	178
Escovas circulares	Circular Brushes Cepillos circulares	MTX	178
Escovas circulares	Circular Brushes Cepillos circulares	MTX	178
Escovas circulares	Circular Brushes Cepillos circulares	MTX	178
Escovas manuais	Hand brushes Cepillos manuales	MTX	181
Escovas manuais	Hand brushes Cepillos manuales	MTX	181
Escovas tipo copo	Cup Brushes Cepillos tipo vaso	MTX	179
Escovas tipo copo	Cup Brushes Cepillos tipo vaso	MTX	179
Escovas tipo copo	Cup Brushes Cepillos tipo vaso	MTX	179
Escovas tipo copo	Cup Brushes Cepillos tipo vaso	MTX	179
Esguicho Ajustável	Adjustable Spray Eschicho ajustable	PALISAD	145
Esguicho Pistola	Squirt Gun Eschicho Pistola	PALISAD	142
Esguicho Pistola	Squirt Gun Eschicho Pistola	PALISAD	142
Espaçador para piso, plástico	Floor spacer, plastic Espaciador de suelo, plástico	MTX	208
Espátula / Betumadeira de aço	Steel spatula Espátula de acero	SPARTA	203
Espátulas cabo de PVC	PVC cable spatulas Espátulas de mango de PVC	MTX	203
Esquadro	Square Escuadro	SPARTA	77
Esquadro Combinado (Uso Industrial)	Combined Square (Industrial Use) Escuadrón Combinado (Uso Industrial)	SPARTA	77



PRODUTOS	TRADUÇÃO	MARCA	PAG.
Esquadro de Aço carbono	Carbon Steel Square Escuadra de acero carbono	MTX	77
Esquadro de alumínio fundido	Cast Aluminum Square Escuadra de aluminio fundido	MTX	77
Estiletes	Stiletto Estiletes	GROSS	186
Estiletes	Stiletto Estiletes	GROSS	186
Estiletes	Stiletto Estiletes	GROSS	186
Estiletes	Stiletto Estiletes	MTX	187
Estiletes	Stiletto Estiletes	MTX	187
Estiletes	Stiletto Estiletes	MTX	187
Estiletes	Stiletto Estiletes	MTX	187
Estiletes	Stiletto Estiletes	SPARTA	188
Estiletes	Stiletto Estiletes	SPARTA	188
"Estojo de Chaves Allen de 9 peças abaulada"	"Allen key case - 9 peices Round edge Estuche de llaves Allen 9 piezas Punta Redonda "	MTX	21
Estojo de Chaves Allen de 9 peças	Allen key case - 9 peices Estuche de llaves Allen 9 piezas	MTX	20
"Estojo de Chaves Allen HEX/Torx de 18 peças"	"Allen HEX/Torx key case - 18 peices Estuche de Llaves Allen HEX/Torx de 18 piezas"	MTX	20
Estojo de Chaves Torx de 9 peças	Torx key case - 9 peices Estuche de Chaves Torx de 9 piezas	MTX	21
Extensão Flexível 1/4"	Flexible Extension-1/4" Extensión Flexible-1/4"	STELS	107
Extensões	Extensions Extensiones	STELS	106
Extensões	Extensions Extensiones	MTX	106
Extensões abaulada	Extensions bulging Extensiones abombadas	MTX	107
Extrator de ervas	Herbal extractor Extractor de hierbas	PALISAD	136
Extrator de ervas daninhas	Weed extractor Extractor de malas hierbas	PALISAD	136
Extrator de grampos	Staple Remover Extractor de grapas	MTX	90

F



PRODUTOS	TRADUÇÃO	MARCA	PAG.
Filtro de ar comprimido	Compressed air filter Filtro de aire comprimido	MTX	124
Fita adesiva	Scotch tape Cinta adhesiva	MTX	205
Formão cabo plástico	Plastic cable chisel Cincel mango de plástico	SPARTA	71
Formões cabo plástico com borracha	Plastic Rubber Cable Chisel Formones mango de plástico con caucho	MTX	71
Funil plástico	Plastic funnel Embudo plástico	SPARTA	123

G



PRODUTOS	TRADUÇÃO	MARCA	PAG.
Garfo 3 dentes	3-prong fork Cuello 3 dientes	PALISAD	135
"Grampeador e Pinador manual - Profissional"	"Stapler and Manual Pincher - Professional Grapadora y Pinador manual - Profesional"	MTX	88
Grampeador Manual	Manual Stapler Grapadora manual	SPARTA	89
Grampeador Pneumático	Pneumatic Stapler Grapadora Neumática	MTX	92
Grampeador Tapeceiro	Stapler Upholsterer Grapadora Tapicerí	MTX	88
Grampeador Tapeceiro Controle de Pressão	Stapler Upholsterer Pressure Control Grapadora Tapicería Control de Presión	MTX	88
Grampeador Tapeceiro de plástico	Stapler Upholsterer Aluminum Grapadora Tapicería de Aluminio	MTX	89
Grampo Angular	Angular Cleat Grapa Angular	SPARTA	66
Grampo em Forma de G	G-shaped clip Grapa en forma de G	MTX	67
Grampo em Forma de G Ajustável	G-shaped clip Adjustable Grapa en forma de G ajustable	MTX	67
Grampo em Forma de G Pintado	G-shaped clip Painted Grapa en forma de G pintado	SPARTA	67
Grampo Multiuso para Marceneiro	Multipurpose Clip for Handyman Grapa Multiuso para carpintero	MTX	66
Grampo Sargento Aperto Rápido	Staple Sergeant Quick Tight Grapa Sargento Apriete Rápido	MTX	66
Grampo Sargento Tipo F	Staple Sergeant Type F Grapa Sargento Tipo F	MTX	66
Grampos	Bobby pins Clips	MTX	91

PRODUTOS	TRADUÇÃO	MARCA	PAG.
Grampos	Clamp Grapa	MTX	90
Haste para suporte serra copo	Stem to support cup saw Vástago para suporte Sierra de agujero	MTX	168
Irrigador Múltiplo	Multiple Irrigator Irrigador Múltiple	PALISAD	148

H



PRODUTOS	TRADUÇÃO	MARCA	PAG.
Irrigador rotativo de plástico	Plastic Rotary Irrigator Irrigador giratorio de plástico	PALISAD	148

I



PRODUTOS	TRADUÇÃO	MARCA	PAG.
Irrigador setorial - tipo espiga	Sectorial irrigator - spike type Irrigador sectorial - tipo espiga	PALISAD	148
Jarreteira para jardim	Garden Garter Jarretera para jardín	PALISAD	142
Jogo de Chaves Fenda / Phillips	Phillips / Screwdrivers Set Juego de Llaves Destornillador / Phillips	SPARTA	34

J



PRODUTOS	TRADUÇÃO	MARCA	PAG.
Jogo de acessórios para compressores	Accessory set for compressors Juego de accesorios para compresores	STELS	125
Jogo de Bits e Brocas	Set of Bits and Drills Juego de Bits y Brocas	MTX	167
Jogo de Bits/Ponteiras 18pçs	Bits / Tips Set 18pcs Juego de Bits / Puntas 18pçs	MTX	28
Jogo de Bits/Ponteiras 7pçs	Bits / Tips Set 7pc Juego de Bits / Puntas 7pç	MTX	26
Jogo de Broca para Concreto - Golden Line	Drill Set for Concrete - Golden line Juego de Broca para Concreto - Golden Line	MTX	160
Jogo de broca para fechadura	Drill for wood Broca para madera	MTX	158
Jogo de brocas chatas para madeira	Set of boring wood drills Juego de brocas para madera	SPARTA	155
Jogo de brocas de 3 pontas para madeira	Set of 3-prong drill bits for wood Juego de brocas de 3 puntas para madera	SPARTA	154
Jogo de brocas longa para madeira	Set of long drills for wood Juego de fresas largas para madera	SPARTA	154
Jogo de Brocas para metal	Set of Metal Drills Juego de Brocas para metal	MTX	165
Jogo de Brocas para metal	Set of Metal Drills Juego de Brocas para metal	MTX	165
Jogo de chave Combinada	Combined key set Juego de clave Combinada	STELS	120
Jogo de chave Combinada	Combined key set Juego de clave Combinada	MTX	116
Jogo de Chave de catraca 11 peças	11 Piece Ratchet Wrench Set Juego de llave de trinquete 11 piezas	STELS	110
Jogo de chave estrela	Set of keys Star Juego de llave Estrella	STELS	117
Jogo de chave fixa	Fixed key set Juego de llave fija	MTX	116
Jogo de chave fixa	Fixed key set Juego de llave fija	STELS	117
Jogo de Chaves Allen de 9 peças acetinado	Satin Allen key set - 9 peices Juego de Chaves Allen de 9 piezas satinado	MTX	17
Jogo de Chaves Allen de 9 peças fosfatizado	"Allen Key Set - 9 peices Phosphatized Juego de Chaves Allen de 9 piezas fosfatizado"	MTX	16
Jogo de Chaves de Precisão 6pçs	Precision Key Set 6pcs Juego de llaves de precisión 6pzs	SPARTA	37
Jogo de Chaves de Precisão 6pçs	Precision Key Set 6pcs Juego de llaves de precisión 6pzs	GROSS	37
Jogo de Chaves de Precisão imantado - 8pçs	Precision Key Set magnetized - 8pcs Juego de llaves de precisión imantado - 8pzs	MTX	37
Jogo de conexão para mangueira	Set of connections for hose Juego de conexiones para la manguera	PALISAD	143
Jogo de engate rápido	Quick coupling kit Juego de acoplamiento rápido	STELS	124
Jogo de escovas	Set of brushes Juego de cepillos	MTX	180
Jogo de escovas circulares onduladas	Set of circular wavy brushes Juego de cepillos circulares ondulados	MTX	180
Jogo de escovas circulares onduladas	Set of circular wavy brushes Juego de cepillos circulares ondulados	MTX	180
Jogo de estiletes	Stiletto set Juego de estiletes	MTX	189
Jogo de estiletes	Stiletto set Juego de estiletes	MTX	189
Jogo de Ferramentas	Tool Set Juego de herramientas	MTX	31
Jogo de Ferramentas de montagem 40pçs	Mounting Tools Set 40pcs Juego de herramientas de montaje 40pzs	SPARTA	38
Jogo de Ferramentas para Bancada 129pçs	Bench Top Tool Set 129pcs Juego de herramientas para banco 129pzs	SPARTA	38

PRODUTOS	TRADUÇÃO	MARCA	PAG.
Jogo de Ferramentas para Bancada 6pçs	Bench Top Tool Set 6pcs Juego de herramientas para banco 6pzs	SPARTA	38
Jogo de Ferramentas/18pçs	Tool Set-18pcs Juego de Herramientas-18pzs	STELS	101
Jogo de Ferramentas/24pçs	Tool Set - 24pcs Juego de Herramientas-24pzs	STELS	101
JOGO DE FERRAMENTAS/29pçs	TOOL SET 29PCS JUEGO DE HERRAMIENTAS 29PZS	STELS	103
Jogo de Ferramentas/39pçs	Tool Set-39pcs Juego de Herramientas-39pzs	STELS	101
JOGO DE FERRAMENTAS/41pçs	TOOL SET 41PCS JUEGO DE HERRAMIENTAS 41PZS	STELS	102
JOGO DE FERRAMENTAS/57pçs	TOOL SET 57PCS JUEGO DE HERRAMIENTAS 57PZS	STELS	103
JOGO DE FERRAMENTAS/94pçs	TOOL SET 94PCS JUEGO DE HERRAMIENTAS 94PZS	STELS	102
Jogo de Formões	Chisels set Juego de Formones	MTX	72
Jogo de formões para entalhador	Chisels set Juego de cinceles	SPARTA	72
Jogo de fresa para madeira	Wood cutter set Juego de fresa para madera	SPARTA	156
Jogo de Lima rotativa	Rotating File Set Juego de Lima rotativa	MTX	156
Jogo de Limas Bastardas 3 pçs	Set of files Juego de rascador	MTX	44
Jogo de Limas Bastardas 5 pçs	Set of files Juego de rascador	MTX	44
Jogo de Pontas montadas	Set of mounted tips Juego de puntas montadas	MTX	182
Jogo de serra copo para cerâmica e telha	"Ceramic and tile glass saw set Juego de Sierra de agujero para cerámica y teja"	MTX	168
Jogo de Soquetes	Socket Set Juego de Enchufe	GROSS	94
Jogo de Soquetes	Socket Set Juego de Sockets	MTX	98
Jogo de Soquetes - 20pçs - 3/4"	Socket Set - 20pcs - 3/4" Juego de Sockets - 20pzs - 3/4"	MTX	100
Jogo de Soquetes - 26pçs - 3/4"	Socket Set - 26pcs - 3/4" Juego de Sockets - 26pzs - 3/4"	MTX	100
Jogo de Soquetes Multifuncional	Socket Set Multifuncional Juego de Enchufe multifuncional	GROSS	95
Jogo de Soquetes sextavados - 10 peças	Socket Set Hexagonal - 10 parts Juego de Sockets hexagonales - 10 piezas	STELS	98
Jogo de Soquetes sextavados - 11 peças	Socket Set Hexagonal - 11 parts Juego de Sockets hexagonales - 11 piezas	STELS	98
Jogo de Soquetes SPLINE	Socket Set SPLINE Juego de Sockets SPLINE	MTX	104
Jogo de Soquetes SPLINE	Socket Set SPLINE Juego de Sockets SPLINE	STELS	105
Jogo de Soquetes/curto	Socket Set /short Juego de Sockets /corto	MTX	104
Jogo de Soquetes/curto	Socket Set /short Juego de Sockets /corto	MTX	104
Jogo de Soquetes/curto	Socket Set /short Juego de Sockets /corto	STELS	105
Jogo de Soquetes/curto	Socket Set /short Juego de Sockets /corto	STELS	105
Jogo de Soquetes/longo	Sockets / Long Set Juego de Sockets / Largo	MTX	104
Jogo de Soquetes/longo	Sockets / Long Set Juego de Sockets / Largo	STELS	105
Jogo de tarraxas para canos metálicos	Set of metal pipe fittings Juego de taras para tuberías metálicas	SPARTA	185
Jogo de tarraxas para canos metálicos	Set of metal pipe fittings Juego de taras para tuberías metálicas	SPARTA	185
Jogo para serra tico tico	Tico-tico saw set Juego para sierra Tico-tico	MTX	191
Jogo para serra tico tico	Tico-tico saw set Juego para sierra Tico-tico	MTX	192
Jogo para serra tico tico	Tico-tico saw set Juego para sierra Tico-tico	MTX	193
Jogo serra copo para madeira	Hole saw set for wood Juego Sierra de agujero para madera	SPARTA	157
Jogo serra copo para madeira	Hole saw set for wood Juego Sierra de agujero para madera	MTX	157
Jogo serra copo para madeira	Hole saw set for wood Juego Sierra de agujero para madera	MTX	157
Jogo serra copo para madeira	Hole saw set for wood Juego Sierra de agujero para madera	MTX	157
"Jogos de Chaves Allen de 9 peças ponta abaulada "	"Allen Key 9-Piece Round edge Juegos de Chaves Allen de 9 piezas Punta redonda"	MTX	17
Jogos de Chaves Allen / Torx Argola	Allen / Torx key set Ring Juegos de Llaves Allen / Torx Anillo	SPARTA	19
Jogos de Chaves Torx de 9 peças	Torx key set - 9 peices Juegos de Chaves Torx de 9 piezas	MTX	16
Junta universal	Universal joint Junta universal	MTX	108
Kit Churrasco	Barbecue kit Kit Barbacoa	PALISAD	152
Kit de reparo para pulverizadores	Spray Repair Kit Kit de reparación para pulverizadores	PALISAD	150

K



PRODUTOS	TRADUÇÃO	MARCA	PAG.
Kit reparo para pistola de pintura	Repair kit for paint spray gun Kit de reparación para pistola de pintura	STELS	127
Lâmina para estilete	Stiletto blade Láminas para estilete	GROSS	186
Lâmina para serrote de arco	Bow hacksaw blade Lámina para serrucho de arco	PALISAD	130

L



PRODUTOS	TRADUÇÃO	MARCA	PAG.
Lâminas para estiletos	Stitching blades Láminas para estiletos	SPARTA	188
Lâminas para estiletos	Stitching blades Láminas para estiletos	MTX	189
Lâminas para estiletos trapezoidais	Vane blades for trapezoidal style Láminas para estiletos trapezoidales	MTX	189
Lâminas para serra tico tico - Jogo	Saw Blades for Tactical Saw - Game Láminas para sierra tico tico - Juego	MTX	190
Lâminas para serra tico tico - Jogo	Saw Blades for Tactical Saw - Game Láminas para sierra tico tico - Juego	MTX	190
Lâminas Serras	Saw blades Láminas Sierras	SPARTA	190
Lâminas Serras	Saw blades Láminas Sierras	MTX	190
Lápis de marceneiro	Woodworking pencils Lápiz de carpintería	SPARTA	201
Ligação para 2 saídas ajustáveis	Connection for 2 adjustable outputs Conexión para 2 salidas ajustables	PALISAD	147
Lima Formato Chata - Murça	Flat Scraper Raspador plano	MTX	43
Lima Formato Meia Cana - Bastarda	Half Cane Scraper Rascador Formato Medias Cana	MTX	42
Lima Formato Meia Cana - Murça	Half Cane Scraper Rascador Formato Medias Cana	MTX	41
Lima Formato Meia Cana - Murça	Half Cane Scraper Rascador Formato Medias Cana	MTX	44
Lima Formato Plano - Bastarda	Flat Scraper Raspador plano	MTX	42
Lima Formato Plano - Murça	Flat Scraper Raspador plano	MTX	41
Lima Formato Quadrada - Murça	Square Format Rascador Formato Cuadrado	MTX	43
Lima Formato Redondo - Bastarda	Round Scraper Rascador Formato Redondo	MTX	42
Lima Formato Redondo - Murça	Round Scraper Rascador Formato Redondo	MTX	41
Lima Formato Redondo - Murça	Round Scraper Rascador Formato Redondo	MTX	43
Lima Formato Triangular - Bastarda	Triangular shape scraper Rascador Formato Triangular	MTX	42
Lima Formato Triangular - Murça	Triangular shape scraper Rascador Formato Triangular	MTX	41
Lima Formato Triangular - Murça	Triangular shape scraper Rascador Formato Triangular	MTX	43
"Linha de Bits Industrial TORX Cromo Molibdênio 5 Peças"	"Industrial Bit Series Chrome Molybdenum 5 Pieces Línea de Bits Industrial Cromo Molibdeno 5 Piezas"	MTX	23
Linha de Bits Ponteira Fenda 5 Peças	Fenda Point Bits Line 5 Pieces Línea de Bits Puntera Fenda 5 Piezas	MTX	23
Linha de Bits Ponteira Phillips 5 Peças	Phillips Point Bits Line 5 Pieces Línea de Bits Puntera Phillips 5 Piezas	MTX	22
Linha de soquetes industriais	Industrial Socket Line Línea de sockets industriales	STELS	97
Lixa	Sandpaper Papel de lija	MTX	183
Lixa	Sandpaper Papel de lija	MTX	183
Lixa	Sandpaper Papel de lija	MTX	183
Luvas para Jardim	Garden gloves Guantes de jardín	PALISAD	150
Luvas para jardim	Garden gloves Guantes de jardín	PALISAD	150
Macaco Hidráulico tipo garrafa	Bottle type hydraulic jack Gato hidráulico tipo botella	SPARTA	122
Macaco Hidráulico tipo jacaré	Alligator Type Hydraulic Jack Gato hidráulico tipo jacaré	SPARTA	121

M



PRODUTOS	TRADUÇÃO	MARCA	PAG.
Macaco Hidráulico tipo jacaré	Alligator Type Hydraulic Jack Gato hidráulico tipo jacaré	SPARTA	121
Macaco Hidráulico tipo jacaré	Alligator Type Hydraulic Jack Gato hidráulico tipo jacaré	STELS	121
Macaco Hidráulico tipo jacaré	Alligator Type Hydraulic Jack Gato hidráulico tipo jacaré	MTX	121
Maçarico	Blowtorch Soplete	MTX	214
Maçarico	Blowtorch Soplete	MTX	214
Maçarico	Blowtorch Soplete	MTX	214



PRODUTOS	TRADUÇÃO	MARCA	PAG.
Machado cabo de fibra	Ax fiber cable Machado cable de fibra	SPARTA	68
Macho	Male Masculino	MTX	184
"Maleta Conjunto de Bits/Ponteiras e Brocas 40pçs "	"Bits / Tips and Drills Set 40pcs Maleta Conjunto de Bits / Puntas y Brocas 40pçs "	MTX	28
Maleta Conjunto de bits e cabeças 26 pçs	Case Set of bits and heads 26 pcs Maleta Conjunto de bits e cabeças 26 pçs	GROSS	27
Maleta Conjunto de bits e cabeças 33 pçs	Case Set of bits and heads 33 pcs Maleta Conjunto de bits e cabeças 33 pçs	GROSS	27
Maleta Conjunto de bits e cabeças 61pçs	Case Set of bits and heads 61 pcs Maleta Conjunto de bits e cabeças 61pçs	MTX	27
Mandril Aperto Rápido	Fast Clamp Chuck Mandril Apriete Rápido	MTX	45
Mandril Auto Lock	Auto Lock Chuck Mandril Auto Lock	MTX	45
Mandril de Chave Manual	Manual Switch Chuck Mandril de llave manual	MTX	45
Mangueira espiral de ar	Spiral air hose Manguera espiral de aire	STELS	124
Marreta oitavada	Octave hammer Mazza octava	SPARTA	12
Marreta oitavada cabo em fibra	Octave hammer with fiber cable Marreta octava con mango de fibra	MTX	12
Marreta Quadrada	Square Mallet Mazza cuadrado	SPARTA	12
Marreta Quadrada cabo longo	Mallet Square Long Cable Mazza cuadrado de mango largo	MTX	13
Martelo bola cabo de fibra emborrachado	Ball hammer with rubber cable Martillo bola con mango de goma	MTX	10
Martelo bola cabo de madeira polida	"Ball hammer with polished wood handle Martillo bola con mango de madera pulida"	SPARTA	10
Martelo de borracha cabo de madeira	Rubber hammer with wooden handle Martillo de goma con mango de madera	SPARTA	13
Martelo de borracha para Cerâmica	Ceramic Rubber Hammer Martillo de goma Cerámica	MTX	14
Martelo de borracha para Porcelanato	Rubber Hammer Porcelain Martillo de goma Porcelanato	MTX	14
Martelo de borracha Preto e Branco	Black and White Rubber Hammer Martillo de goma Blanco y negro	MTX	14
Martelo pena cabo de madeira	Machinist's hammer wooden handle Martillo de pena con mango de madera	SPARTA	10
Martelo pena cabo de madeira pintado	"Machinist's hammer painted wood cable Martillo de pena mango de madera pintada"	MTX	10
Martelo Poliuretano anti-retorno	Anti-return polyurethane hammer Martillo Poliuretano anti-retorno	MTX	13
Martelo unha	Claw Hammer Martelo unha	MTX	12
Martelo unha Cabeça Imantada	Claw Hammer Head Magnet Martelo unha Cabeça imã	MTX	11
Martelo unha Cabo de fibra	Claw hammer Fiber cable Martillo unha mango de fibra	MTX	11
Martelo unha cabo de madeira	Claw hammer wooden handle Martillo unha mango de madera	SPARTA	11
MarteloUnhaTubularcomcaboemborrachado	"Tubular Nail Hammer with Rubberized Cable Martillo Uña Tubular con Mango de goma"	SPARTA	11
Medidor de distância a laser	Laser Distance Meter Medidor de distancia láser	GROSS	82
"Mesas dobráveis de alumínio com tampo de MDF "	"Aluminum folding tables with MDF tops Mesas plegables de aluminio con tableros de MDF"	PALISAD	150
Micrômetro	Micrometer Micrómetro	MTX	76
Mini - Pá de bico	Mini Shovel Mini - Pala de pico	PALISAD	141
"Mini Alicates Bico Meia-Cana Curvo Longo (150mm)"	"Mini Pliers Long Beak Medium Curved Mini Pinza Punta Media-Canã Curvo Largo"	GROSS	47
Mini Alicates Bico Meia-Cana Curvo	Mini Pliers Beak Half-Cane Curved Mini Pinza Punta Media-Canã Curvo	MTX	53
Mini Alicates Bico Meia-Cana Curvo (125mm)	Pliers Beak Half-Cane Curved Mini Pinza Punta Media-Canã Curvo Mini	GROSS	46
Mini Alicates Bico Meia-Cana Reto	Mini Pliers Beak Half-Cane Straight Mini Pinza Punta Media-Canã Reto	MTX	53
Mini Alicates Bico Meia-Cana Reto (125mm)	Pliers Beak Half-Cane Straight Mini Pinza Punta Media-Canã Reto Mini	GROSS	46
Mini Alicates Bico Meia-Cana Reto (127mm)	Pliers Beak Half-Cane Straight Mini Pinza Punta Media-Canã Reto Mini	GROSS	47
Mini Alicates Bico Redondo (127mm)	Mini Round Beak Pliers Mini Pinza Punta Redonda	GROSS	47
Mini Alicates Corte Diagonal	Mini Diagonal Cutting Pliers Mini Pinza Corte Diagonal	MTX	53
Mini Alicates Corte Diagonal (110mm)	Diagonal Cutting Pliers Mini Pinza Corte Diagonal Mini	GROSS	46
Mini Alicates Corte Frontal (105mm)	Mini Front Cutting Pliers Mini Pinza Corte Frontal	GROSS	47
Mini Alicates Universal	Mini Universal pliers Mini Alicates Universal	MTX	53
Mini Alicates Universal (120mm)	Universal pliers Mini Alicates Universal Mini	GROSS	46
Mini arco de serra	Mini sawing bow Mini arco de sierra	MTX	195
Mini cortador de tubos	Mini tube cutter Mini cortador de tubos	MTX	196
Mini torno/morsa 70mm base articulada	Mini lathe / vise 70mm hinged base Mini torno / morsa 70mm base articulada	SPARTA	63

PRODUTOS	TRADUÇÃO	MARCA	PAG.
Mini torno/morsa articulado com ventosa	"Mini articulated vice / vise with suction cup Mini torno / morsa articulado con ventosa"	SPARTA	62
Misturador de massa com haste sextavada	Mass Mixer Mezclador de masa	MTX	202
Misturador de tinta	Ink Mixer Mezclador de tinta	MTX	202
Misturador de tinta com encaixe SDS Plus	Mass Mixer Mezclador de masa	MTX	202
Multiteste Digital LCD	Multitest Digital LCD Multifunción Digital LCD	SPARTA	36
Multiteste Digital LCD led	Multitest Digital LCD led Multifunción Digital LCD led	SPARTA	36
Nível 2 bolhas	Level 2 bubbles Nivel 2 burbujas	SPARTA	79
NÍVEL A LASER 5 LINHAS	5 LEVEL LASER LEVEL NIVEL A LASER 5 LÍNEAS	MTX	84

N



PRODUTOS	TRADUÇÃO	MARCA	PAG.
Nível a laser com tripé	Laser Level with Tripod Nivel láser con trípode	MTX	81
Nível a laser com tripé	Laser Level with Tripod Nivel láser con trípode	MTX	81
Nível a Laser de alta precisão com tripé	"High Precision Laser Level with Tripod Nivel láser de alta precisión con trípode"	MTX	83
Nível a laser esquadro	Level laser square Nivel láser escuadra	MTX	80
Nível a laser esquadro	Level laser square Nivel láser escuadra	MTX	80
Nível de Alumínio	Level of Aluminum Nivel de aluminio	MTX	78
Nível de Alumínio	Level of Aluminum Nivel de aluminio	MTX	78
Nível de Alumínio 3 Bolhas	Level of Aluminum 3 Bubbles Nivel de aluminio 3 burbujas	MTX	78
Nível de alumínio imantando	Level of aluminum magnetizing Nivel de aluminio imantando	MTX	79
Nível de canto	Level of corner Nivel de esquina	SPARTA	82
Nível Plástico imantado	Plastic Level magnetized Nivel Plástico imantado	SPARTA	79
Nível Trapezoidal	Trapezoidal Level Nivel Trapezoidal	MTX	79
Paquímetro Digital	Digital Caliper Calibrador Digital	MTX	76
Paquímetro Universal	Universal Caliper Calibrador Universal	MTX	76

P



PRODUTOS	TRADUÇÃO	MARCA	PAG.
Pazinha	Little Shovel Pequeña pala	PALISAD	138
Pazinha	Little Shovel Pequeña pala	PALISAD	139
Pazinha	Little Shovel Pequeña pala	PALISAD	136
Pazinha estreita	Little paw Pala estrecha	PALISAD	136
Pé de cabra	Wrecking Bar Barreta Sacaclavos	SPARTA	72
Pé de cabra	Wrecking Bar Barreta Sacaclavos	MTX	72
Pedras de afiar	Sharpening stones Piedras de afilado	MTX	182
Pedras de afiar	Sharpening stones Piedras de afilado	MTX	182
Pinador Pneumático / 10-50mm	Pneumatic Pincher/10-50mm Pintor Neumático/10-50mm	MTX	92
Pinos	Pines Pinos	MTX	91
Pinos / Pregos	Pines / Nails Pinos / Clavos	MTX	90
Pistola de jateamento de areia	Sand blasting gun Pistola de chorro de arena	STELS	127
Pistola de limpeza	Cleaning gun Pistola de limpieza	STELS	126
Pistola de pintura	Spray gun Pistola de pintura	STELS	128
Pistola de pintura	Spray gun Pistola de pintura	STELS	128
Plaina Profissional	Professional Plaine Cepilladora profesional	SPARTA	68
Plainas Hobbie	Hobbie Planers Llanas Hobbie	SPARTA	68
Pó de giz	Chalk powder Polvo de tiza	MTX	201
Ponteiro	Pointer Puntero	MTX	159
Ponteiro	Pointer Puntero	MTX	159
Ponteiro Redondo	Round Pointer Puntero Redondo	SPARTA	61

PRODUTOS	TRADUÇÃO	MARCA	PAG.
Ponteiro Sextavada com protetor	Hexagonal Pointer with Protector Puntero Sextava con protector	SPARTA	61
Porta Cossinetes	Door Cossinetes Puerta Cossinetes	MTX	184
Porta eletrodo	Electrode holder Puerta electrodo	MTX	215
Porta ferramentas	Toolholder Puerta de herramientas	MTX	212
Prumo / Nível a Laser com tripé	Plumb / Laser Level with Tripod Prumo / Nivel a láser con trípode	MTX	81
Prumo de aço	Steel plumbing Prumo de acero	MTX	205
Prumo e nível a laser	Plummet and laser level Prumo y nivel láser	MTX	80
Pulseira Magnética	Magnetic Bracelet Pulsera magnética	MTX	29
Pulverizadores agrícolas	Agricultural Sprayers Pulverizadores agrícolas	PALISAD	149
Raspadores de rejunte	Grout Scrapers Rascadores de rejunte	MTX	198
Raspadores de rejunte	Grout Scrapers Rascadores de rejunte	MTX	198

R



PRODUTOS	TRADUÇÃO	MARCA	PAG.
Rebitador Manual Profissional	Professional Manual Riveter Rebajador Manual Profesional	GROSS	86
Rebitador Manual Tipo Alavanca	Manual Riveter Type Lever Rebajador Manual Tipo Palanca	MTX	87
Rebitador Manual Tipo Alavanca	Manual Riveter Type Lever Rebajador Manual Tipo Palanca	SPARTA	87
Rebitador Manual Tipo Alicate	Manual Riveter Pliers Type Rebajador Manual Tipo Alicate	MTX	87
Rebitador Tipo Alicate	Riveter Pliers Type Rebajador Tipo Alicate	MTX	86
Rebites de repuxo	Flake rivets Rejillas de repuesto	MTX	91
Rebolos diamantados	Diamond wheels Rebolos diamantados	MTX	169
Removedor para anéis de pressão com bicos	"Pressure Ring Remover with Nozzles Eliminador para anillos de presión con boquillas"	SPARTA	50
Rodas de lixa	Sandpaper wheels Ruedas de lija	MTX	175
Rodel para cortador de pisos	Rodel for floor cutter Rodillo para cortador de pisos	MTX	207
Rodizio de GEL giratório com freio	Rotary GEL caster with brake Rueda de GEL giratoria con freno	PALISAD	211
Rodizio de GEL giratório sem freio	Rotary GEL caster without brake Rueda de GEL giratoria sin freno	PALISAD	211
Rodizio fixo de pvc e poliuretano com freio	"Fixed pvc and polyurethane brake caster with brake Rodamiento fijo de pvc y poliuretano con freno"	PALISAD	211
Rodizio Fixo sem freio	Fixed caster without brake Rodamiento fijo sin freno	PALISAD	210
Rodizio Fixo sem freio	Fixed caster without brake Rodamiento fijo sin freno	PALISAD	211
Rodizio giratório com freio	Rotary caster with brake Rueda giratoria con freno	PALISAD	210
Rodizio PVC fixo sem freio	Fixed PVC caster without brake Rodamiento de PVC fijo sin freno	PALISAD	210
Rodizio PVC giratório sem freio	Rotary PVC caster with brake Rueda PVC giratoria con freno	PALISAD	210
Rodo multiuso	Multipurpose wheel Rodo multiuso	STELS	123
Rolo para pintura de canto	Roll for corner painting Rodillo para pintura de esquina	MTX	200
Saca polias	Remove pulleys Saca poleas	SPARTA	122
Sacho combinado duas pontas	Hoe combined two ends Azada combinado duas extremidades	PALISAD	137

S



PRODUTOS	TRADUÇÃO	MARCA	PAG.
Sacho combinado duas pontas	Hoe combined two ends Azada combinado duas extremidades	PALISAD	137
Sacho combinado duas pontas	Hoe combined two ends Azada combinado duas extremidades	PALISAD	138
Sacho combinado duas pontas	Hoe combined two ends Azada combinado duas extremidades	PALISAD	140
Serra copo - Wídea	Cup saw - Wídea Sierra de agujero - Wídea	MTX	158
Serra copo aço rápido	Quick steel cup saw Sierra de agujero de acero rápido	MTX	166
Serra copo para cerâmica e telha	Ceramic cup saw and tile Sierra de agujero para cerámica y teja	MTX	168
Serra copo para vidro	Cup saw for glass Sierra de agujero para vidrio	MTX	167
Serra copo para vidro e cerâmica	Cup Saw for glass and ceramics Sierra de agujero para vidrio y cerámica	SPARTA	167
Serra meia esquadria manual de precisão	Precision half-miter saw Sierra media escuadra manual de precisión	MTX	69
Serra meia esquadria manual de precisão	Precision half-miter saw Sierra media escuadra manual de precisión	MTX	69

PRODUTOS	TRADUÇÃO	MARCA	PAG.
Serrote com cabo de madeira	Hacksaw with wooden handle Sierra con cable de madera	SPARTA	71
Serrote de costa para madeira 12 TPI	Wood sawing saw 12 TPI Serrucho de costa para madera 12 TPI	MTX	70
Serrote de poda	Pruning saw Serrucho de poda	PALISAD	130
Serrote para galhos 350 mm / 14"	Slicer for branches Serrucho para ramas	PALISAD	130
Serrote para gesso/Drywall	Plaster saw/drywall Serrucho para yeso / Drywall	MTX	70
Serrote para gesso/drywall cabo de madeira	"Plaster saw/drywall wooden cable Serrucho para yeso / Drywall mango de madera"	SPARTA	71
Serrote para madeira	Miter Saw Blade Lámina para sierra media escuadra	MTX	70
Soquete para vela estriado	Socket for candle Enchufe para la vela	GROSS	94
Soquetes Estriado	Striated Sockets Enchufe Estriado	STELS	94
Soquetes Estriado 1/2"	Socket Stretch 1/2 " Enchufes Estriado 1/2 "	STELS	96
Soquetes Longo Sextavado	Long Sockets Sixth Enchufes Largo hexagonal	STELS	96
Soquetes Magneticos	Magnetic Sockets Soportes Magneticos	MTX	29
Soquetes Sextavado 1/2"	Sixth Sockets 1/2" Enchufes Sextavado 1/2"	MTX	99
Soquetes Sextavados Temperados	Tempered Hexagonal Sockets Enchufes Sexto Templado	STELS	95
Suporte / haste de fixação para serra copo	"Clamping bracket / stem for cup saw Soporte / vástago de fijación para Sierra de agujero"	MTX	166
Suporte de boina	Beret holder Soporte de boina	MTX	174
Suporte para furadeira	Drill stand Soporte para taladro	SPARTA	215
Suporte para serra copo	Cup saw holder Soporte para Sierra de agujero	MTX	168
Taco lixador	Sanding pad Taco lijador	SPARTA	183
Talhadeira	Chisel Cincel	MTX	159

T



PRODUTOS	TRADUÇÃO	MARCA	PAG.
Talhadeira	Chisel Cincel	MTX	159
Talhadeira Ponta Chata	Tip Flat Stone Chisel Cincel Punta Plana	SPARTA	61
Talhadeira Plana	Flat Stone Chisel Cincel Plano	SPARTA	61
Talhadeira Sextavada com protetor	Hexagonal Cleaver with protector Taladradora Sexta con protector	SPARTA	61
Tesoura corta vergalhões	Scissors cuts rebar Tijera corta barras	MTX	196
Tesoura direita para chapas	Right Scissor for Sheets Tijera derecha para chapas	MTX	194
Tesoura esquerda para chapas	Left-handed scissors for plates Tijera izquierda para chapas	MTX	194
Tesoura para chapas	Shears for plates Tijeras para chapas	SPARTA	194
Tesoura para cortar galhos secos e duros	"Scissors for cutting hard and dry twigs Tijeras para cortar ramas secas y duras"	PALISAD	131
Tesoura para galhos até 25mm	Scissor for branches up to 25mm Tijeras para ramas hasta 25mm	PALISAD	132
Tesoura para Grama 310mm	Scissors for Grass 310mm Tijeras para Hierba 310mm	PALISAD	134
Tesoura para Grama 330mm	Scissors for Grass 330mm Tijeras para Hierba 330mm	PALISAD	134
Tesoura para Grama 520mm	Scissors for Grass 520mm Tijeras para Hierba 520mm	PALISAD	134
Tesoura para Grama 560mm	Scissors for Grass 560mm Tijeras para Hierba 560mm	PALISAD	134
Tesoura para Jardim	Garden Scissors Tijera para Jardín	PALISAD	131
Tesoura para Jardim	Garden Scissors Tijera para Jardín	PALISAD	132
Tesoura para Jardim	Garden Scissors Tijera para Jardín	PALISAD	132
Tesoura reta para chapas	Straight sheet shears Tijeras rectas para chapas	MTX	194
Tesouras corta galhos até Ø25mm	Scissors cuts branches up to Ø25mm Tijeras corta ramas hasta Ø25mm	PALISAD	133
Tesouras corta galhos até Ø30mm	Scissors cuts branches up to Ø30mm Tijeras corta ramas hasta Ø30mm	PALISAD	133
Tesouras corta galhos até Ø35mm	Scissors cuts branches up to Ø35mm Tijeras corta ramas hasta Ø35mm	PALISAD	133
Tesouras corta galhos Ø25mm	Scissors cuts branches up to Ø25mm Tijeras corta ramas hasta Ø25mm	PALISAD	133
Tornos / Morsas Base Giratória	Vices turntables Prensatornillos base rotativos	MTX	64
Tornos / Morsas de Bancada	Bench Vices Prensatornillos	MTX	64
Torquês Armador	Concretor's Pincers Tenaza para armar	SPARTA	55
Torquês Azulejista	Tile Pincers Tenaza para azulejo	SPARTA	55



PRODUTOS	TRADUÇÃO	MARCA	PAG.
Torquímetro	Torque meter Llave dinamométrica	MTX	111
Torquímetro eletrônico	Electronic torque wrench Torquímetro electrónico	GROSS	111
Trava Cabo de Aço	Locks Steel Cable Bloqueos Cable de Acero	MTX	216
Trava Cabo de Aço	Locks Steel Cable Bloqueos Cable de Acero	MTX	216
Trava Cabo de Aço	Locks Steel Cable Bloqueos Cable de Acero	MTX	216
Trena	Trains Cinta Métrica	SPARTA	74
Trena	Trains Cinta Métrica	MTX	74
Trena	Trains Cinta Métrica	GROSS	75
Trena Longa	Long Trains Cinta Métrica Larga	SPARTA	75
Tripé	Tripod Tripode	MTX	83
Válvula pulverizadora	Spray Valve Válvula pulverizadora	PALISAD	143
Vassoura para grama e jardim	Grass and garden broom Escoba para césped y jardín	PALISAD	140
Vassoura para grama e jardim 22 dentes	Grass and garden broom Escoba para césped y jardín	PALISAD	138

V



PRODUTOS	TRADUÇÃO	MARCA	PAG.
Ventosa Plástica	Plastic Suction Cup Ventosa Plástica	MTX	206
Ventosas de Alumínio (Uso Profissional)	"Aluminum Suction Cups (Professional Use) Ventosas de Aluminio (Uso Profesional)"	MTX	206
Vira macho	Male Tool Macho Herramienta	MTX	184
Vira macho	Male Tool Macho Herramienta	MTX	184



Tabelas de conversão de torques



Newton.metro (N.m) em kilograma-força.metro (kgf.m)

$$1 \text{ N.m} = 0,10197 \text{ kgf.m}$$

N.m	0	10	20	30	40	50	60	70	80	90
	(kgf.m)									
0	0	1.02	2.04	3.06	4.08	5.10	6.12	7.14	8.16	9.18
100	10.20	11.22	12.24	13.26	14.28	15.30	16.31	17.33	18.35	19.37
200	20.39	21.41	22.43	23.45	24.47	25.49	26.51	27.53	28.55	29.57
300	30.59	31.61	32.63	33.65	34.67	35.69	36.71	37.73	38.75	39.77
400	40.79	41.81	42.83	43.85	44.87	45.89	46.91	47.93	48.95	49.97
500	50.99	52.00	53.02	54.04	55.06	56.08	57.10	58.12	59.14	60.16
600	61.18	62.20	63.22	64.24	65.26	66.28	67.30	68.32	69.34	70.36
700	71.38	72.40	73.42	74.44	75.46	76.48	77.50	78.52	79.54	80.56
800	81.58	82.60	83.62	84.64	85.66	86.68	87.70	88.71	89.73	90.75
900	91.77	92.79	93.81	94.83	95.85	96.87	97.89	98.91	99.93	100.95
1000	101.97	102.99	104.01	105.03	106.05	107.07	108.09	109.11	110.13	111.15

Newton.metro (N.m) em libra-força.pé (lbf.pé)

$$1 \text{ N.m} = 0,73756 \text{ lbf.pé}$$

N.m	0	1	2	3	4	5	6	7	8	9
	(lbf.pé)									
0	0	0.74	1.48	2.21	2.95	3.69	4.43	5.17	5.90	6.64
10	7.38	8.12	8.86	9.59	10.33	11.07	11.81	12.54	13.28	14.02
20	14.76	15.50	16.2	16.97	17.71	18.45	19.19	19.93	20.65	21.40
30	22.14	22.88	23.62	24.35	25.10	25.83	26.57	27.31	28.04	28.78
40	29.52	30.26	31.00	31.73	32.47	33.21	33.95	34.69	35.42	36.16
50	36.90	37.64	38.38	39.11	39.85	40.59	41.33	42.07	42.80	43.54
60	44.28	45.02	45.76	46.49	47.23	47.97	48.71	49.45	50.18	50.92
70	51.66	52.40	53.14	53.87	54.61	55.35	56.09	56.83	57.56	58.30
80	59.04	59.78	60.52	61.25	62.00	62.73	63.47	64.21	64.94	65.68
90	66.42	67.16	67.90	68.63	69.37	70.11	70.85	71.59	72.32	73.06
100	73.80	74.54	75.28	76.01	76.75	77.49	78.23	78.97	79.70	80.44

libra-força.pé em Newton.metro

$$1 \text{ lbf.pé} = 1,356 \text{ N.m}$$

lbf.pé	0	1	2	3	4	5	6	7	8	9
	(N.m)									
0	0	1.36	2.71	4.07	5.42	6.78	8.14	9.49	10.85	12.20
10	13.56	14.92	16.27	17.63	18.98	20.34	21.70	23.05	24.41	25.76
20	27.12	28.48	29.83	31.19	32.54	33.90	35.26	36.61	37.97	39.32
30	40.68	42.04	43.39	44.75	46.10	47.46	48.82	50.17	51.53	52.88
40	54.24	55.60	56.95	58.31	59.66	61.02	62.38	63.73	65.09	66.44
50	67.80	69.16	70.51	71.87	73.22	74.58	75.94	77.29	78.65	80.00
60	81.36	82.72	84.07	85.43	86.78	88.14	89.50	90.85	92.21	93.56
70	94.92	96.28	97.63	98.99	100.34	101.70	103.06	104.41	105.77	107.12
80	108.48	109.84	111.19	112.55	113.90	115.26	116.62	117.97	119.33	120.68
90	122.04	123.40	124.75	126.11	127.46	128.82	130.18	131.53	132.89	134.24
100	135.60	136.96	138.31	139.67	141.02	142.38	143.74	145.09	146.45	147.80

1 Lbf. pé = 12 Lbf.pol

Fator de cálculo de torques

Unidade Conhecida	Unidade de Medição					
	= N.cm	= N.m	= kgf.cm	= kgf.m	= lbf.pol	= lbf.pé
N.cm	1	0.01	0.10197	0.00102	0.0885	0.00738
N.m	100	1	10.197	0.10197	8.851	0.7376
kgf.cm	9.807	0.09807	1	0.01	0.868	0.0723
kgf.m	980.7	9.807	100	1	86.796	7.233
lbf.pol	11.298	0.11298	1.152	0.01152	1	0.0833
lbf.pé	135.58	1.3558	13.825	0.13825	12	1

SIMBOLOGIA TÉCNICA

TECHNICAL SYMBOLS | SIMBOLOGÍA TÉCNICA

PRINCIPAL



CÓDIGO
CODE



CARACTERÍSTICAS
Technical Features



PESO CABEÇA
Head Weight
Peso Cabeça



PESO TOTAL
Total Weight



PESO TOTAL
Total Weight
Peso Total



CAIXA MASTER
Box Master | Caja Máster



QUANT. MINÍMA
Quant. Minimum
Cantidad Mínimo



DIÂMETRO
Diameter
Diámetro



PERFIL FENDA
Fenda profile | Perfil fenda



PERFIL PHILLIPS
Profile phillips | Perfil phillips



PERFIL POZIDRIVE
Profile pozidrive | Perfil pozidrive



PERFIL TORX - bit/ponta
Profile TORX - bit/tip
Perfil TORX - bit/punta



PERFIL TORX com guia
Profile TORX with guide
Perfil TORX con guía



PERFIL TORX soquete/encaixe
Profile TORX socket / fitting
Perfil TORX enchufe / encajar



PERFIL SEXTAVADO bit/ponta
Profile Six point bit/tip
Perfil sextavado bit/punta



PERFIL SEXTAVADO soquete/encaixe
Profile Six point socket / fitting
Perfil sextavado enchufe / encaja



PERFIL SEXTAVADO soquete/encaixe
Profile Six point socket / fitting
Perfil sextavado enchufe / encaja



PERFIL SEXTAVADO com guia
Profile Six point with guide
Perfil sextavado con guía



PERFIL BI-SEXTAVADO soquete/encaixe
Profile twelve point socket / fitting
Perfil bi-sextavado enchufe / encaja



PERFIL SPLINE soquete/encaixe
Profile SPLINE socket / fitting
Perfil SPLINE enchufe / encaja



PERFIL SPLINE bit/ponta
Profile SPLINE point bit/tip
Perfil SPLINE bit/punta



PERFIL SPANNER bit/ponta
Profile SPANNER point bit/tip
Perfil SPANNER bit/punta



PERFIL SPAN bit/ponta
Profile SPAN point bit/tip
Perfil SPAN bit/punta



USO PARA FERRAMENTAS PNEUMÁTICAS
Use for pneumatic tools
Uso para herramientas neumáticas



EMBALAGEM TIPO BLISTER
Blister type packaging
Embalaje tipo blister

BLISTER



ENCAIXE SDS MAX
Socket SDS MAX
Encaje SDS MAX



ENCAIXE SDS PLUS
Socket SDS PLUS
Encaje SDS PLUS



ÁÇO CROMO-VANÁDIO
Steel chromo-vanádio | Acero cromado-vanadio



ÁÇO CROMO-MOLIBDÊNIO
Chrome-molybden steel | Acero cromado-molibdenio



ÁÇO S2
S2steel | Acero S2



ÁÇO FORJADO - DUREZA 45HRc
Forged steel - hardness 45hrc
Acero forjado - dureza 45hrc



ÁÇO CARBONO
Carbon steel
Acero carbono



GRAU DE DUREZA DO AÇO
Strength of steel hardness
Grado de dureza del acero



IMÃ MINEDIN
Magnet minedin
Ímã minedin



PARA TRABALHOS EM ÁREAS COM VOLTAGEM DE ATÉ 1000V
For work in areas with voltage up to 1000V
Para trabajos en áreas con voltagen de hasta 1000V



PADRÃO INTERNACIONAL DE SEGURANÇA PARA PRODUTOS ELETRO-ELETRÔNICOS

International standard of safety for electronic-electronic products

Estándar internacional de seguridad para productos electrón-electrónicoS



NORMA INTERNACIONAL IEC 60900:2004 PARA PRODUTOS ELETRO-ELETRÔNICOS

International standard iec 60900: 2004 For electronic-electronic products

Norma internacional iec 60900: 2004 Para productos electrón-electrónicos



NORMA INSTITUTO ALEMÃO PARA NORMATIZAÇÃO

O uso da norma DIN, bem como de outras normas internacionais, assegura um padrão de qualidade na fabricação de produtos e equipamentos, refletindo diretamente na segurança do consumidor final.

GERMAN INSTITUTE FOR NORMATIZATION The use of the DIN standard, as well as other international standards, ensures a quality standard in the manufacture of products and equipment, directly reflecting the safety of the final consumer.

INSTITUTO ALEMÁN PARA NORMATIZACIÓN El uso de la norma DIN, así como de otras normas internacionales, asegura un estándar de calidad en la fabricación de productos y equipos, reflejando directamente en la seguridad del consumidor final.

Brasil | Bulgária | Cazaquistão | China | Rússia | Ucrânia | Hungria | Bielorrússia | Polónia
Uzbequistão | Emirados Árabes | Romênia | Estados Unidos



WWW.TOOLSWORLD.COM.BR
WWW.INSTRUMENT.RU

Vieia Urga, 810 - Guarulhos - Bonsucesso - Cep 07175-332
Telephone: + 55 11 2466-8080
SAC: 0800 777 8 999
email@toolsworld.com.br