

Competing at the edge of change

The new standard for
fluid conveyance



Powering Business Worldwide

There's a spirited energy at Eaton.

It comes from the alignment of some of the most respected names in fluid power to build a brand you can trust to meet the world's demand for high-efficiency hydraulic systems.

Our goal is simple: To provide unique fluid power solutions across a range of mobile and stationary markets that keep businesses competing at the leading edge of change.

So, why partner with Eaton?

After all, we know you have choices. You partner with Eaton because every aspect of our business is focused on ensuring your continued success:

- Focused manufacturing that anticipates the needs of a global business environment
- Streamlined product commercialization that deploys tested and qualified products that meet or exceed industry standards
- Product features and attributes that deliver improved performance at a good value
- Safety is treated as a priority within our culture, and yours. Crimp with confidence knowing that Eaton pairs its hoses and fittings after rigorous qualification and testing procedures
- Dedicated people, who focus daily on meeting your needs
- Engaging marketing and sales programs designed to educate and enable growth in partnership with Eaton

Aeroquip® core hydraulic products

Hose products

Our new core premium hoses for OEM or aftermarket use exceed industry standards for pressure, temperature and abrasion resistance, with options adapted to handle your toughest jobs. Look for Triple Crown Advantage hoses for the highest pressure and temperature ratings to extend the life of your hose. Available in braided and spiral hose constructions.



 Look for the Triple Crown Advantage

Specialty hose

NG-TW hose
35NG hose

Certified by:



Fittings



TTC Series

One-piece "Bite-the-wire" style hose fitting that is qualified with virtually all Aeroquip® one and two wire braided hydraulic hoses, and features DuraKote™ plating technology.



4S/6S Spiral Series

A higher performing spiral hose assembly for the most demanding applications while using a simple more user-friendly hose and hose fitting assembly process, featuring DuraKote™ plating technology.

Tooling

ET1187 Portable Variable Crimp Machine

Eaton ProCrimp ET1187 crimp machine with the micrometer feature: It's as simple as turning the collar to the correct color to match the layline on the hose.

- Color-coded collar matches core hose layline for easy set-up
- TTC fittings and applicable hoses in sizes 1/4" through 1"
- TTC12/4S fittings and applicable hoses in sizes 3/8" through 5/8"
- 4S fittings and applicable hoses in sizes 3/4" through 1"



Micrometer

Aeroquip provides confidence in hose assembly, corrosion and leakage protection.

Engineered Assemblies

Eaton's Aeroquip hoses and fittings are engineered and qualified to work as a system ensuring your confidence in a high quality hose assembly. The 4-Step **MatchMate™** system for braided and spiral hose assemblies ensure proper mating of hose and qualified fittings.

4 Step Hose Identification System

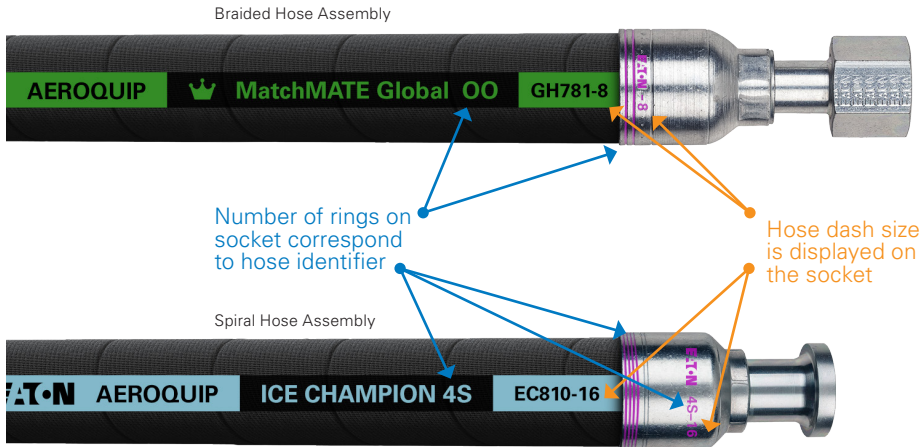

DURA-KOTE Plating Technology

Hose fittings that will now offer 3x the corrosion protection on carbon steel fittings as compared to competitive hose fittings. Eaton's DURA-KOTE fittings provide up to 1000 hours of corrosion protection. This is a huge step forward in metal fitting corrosion protection.

3X Carbon Steel Corrosion Protection



Corrosion of current carbon steel adapters after 650 hours of exposure to salt spray testing.

DURA-SEAL™ Technology

This patent-pending innovation from Eaton eliminates hose assembly cool-down leakage, while extending hose assembly life, reducing equipment down-time.

Class 0 Cool-Down Leakage Protection



4S/6S Fitting



Table of Contents

A	APPLICATION DATA
B	HYDRAULIC HOSE
C	GENERAL PURPOSE HOSE
D	INDUSTRIAL HOSE
E	AIR CONDITIONING AND REFRIGERATION
F	TRANSPORTATION
G	TEFLON HOSE
H	CRIMP FITTINGS
I	REUSABLE AND FIELD ATTACHABLE FITTINGS
J	ADAPTERS
K	ACCESSORIES
L	ASSEMBLY EQUIPMENT
M	INDEX

Hose products

Hose fittings

TABLE OF CONTENTS

Application data	Section A
Safety information	A-4
Hose selection	
Selection and Installation	A-5
Hose numbering system	A-7
Agency listings	A-8
Hose dash size to max operating pressure	A-11
Hose fitting pressure charts	A-13
Fluid compatibility	A-15
Flow capacities	A-25
Flow capacities pressure drop	A-26
Hose routing and installation	A-27
Analyzing failures	A-28
Fluid connectors	
Fluid connectors identification	A-31
Thread size chart	A-32
Proper tube installation	A-33
Maximum operating pressure - tubing	A-34
Recommended wall thickness - tubing	A-35
Hydraulic tubing material specifications	A-35
Non-threaded connections	A-36
American connections	A-36
ISO connections	A-39
German connections	A-40
French connections	A-43
British connections	A-43
Japanese connections	A-44
O-Ring pilot thread sizes	A-46
Thread engagement	A-47
Metric thread dimensions	A-48
Conversion tables	A-49
Assembly instructions	
Assembly torque	A-50
Assembly terms and tips	A-51
Maintenance	A-52
Hose and reusable fittings	A-53
Accessories	A-59

TABLE OF CONTENTS (Continued)

Hose

Hydraulic Hose	Section B
General Purpose Hose	Section C
Industrial Hose	Section D
Air conditioning and refrigeration	Section E
Transportation	Section F
Teflon	Section G

Hose Fittings

Crimp Fittings	Section H
Global TTC	H-5-56
Global nipples (Skive)	H-5-56
Global OTC	H-5-56
Spiral (4S/6S)	H-57
Teflon PTFE (FC Series)	H-78
Truck and fuel (FJ Series)	H-80
Split flange kits	H-87, H-88
O-Rings and kits	H-89

Reusable and field attachable	Section I
Socket Data	I-3
SAE 100R5 style	I-4
Braided one-wire 100R1 TTC	I-17
Braided two-wire HI-PAC	I-20
100R2 skive style	I-26
100R2 TTC	I-38
Spiral hose	I-41
SOCKETLESS™	I-48
Specialty hose, power steering & air brake	I-54
PTFE "Super gem"	I-57
Split Flange kits	I-61
O-Rings	I-63

Adapters

Adapters	Section J
Configuration Index	J-2
Application data	J-12
Part structure	J-15
ORS-TF fillings	J-17
ORS braze type fittings	J-18
ORS/SAE O-Ring boss	J-21
ORS/NPTF	J-26
ORS to SAE 37° (JIC) flare	J-28
ORS/ORS	J-28
ORS accessories	J-33

SAE O-Ring boss/SAE O-Ring boss	J-35
Pipe to Pipe	J-38
Pipe to 37° flare	J-50
Pipe to 45° flare	J-62
Pipe to SAE O-Ring boss	J-64
Pipe to braze and weld	J-67
SAE 37° (JIC) flare union	J-67
SAE 45° flare union	J-75
SAE O-Ring boss to 37° flare	J-76
SAE split flange to ORS	J-81
SAE split flange to 37° flare	J-84
SAE swivel flange to SAE split flange	J-87
SAE flareless to 37° union	J-88
Braze and weld to split flange	J-89
Braze weld to 37°, flare +-91	
Versil-Flare™	J-92
Specials	J-94
Metric to 37° flare	J-95
ORS to metric	J-98
BSPP to 37° flare	J-99
BSPT to 37° flare	J-100
JIS 30° to 37° flare	J-100
Stainless steel adapters	J-101
7000 series Ermeto	J-107

Accessories	Section K
Protective coils and sleeves	K-2
Clamps	K-5
Hose protectors	K-6
Accessories to hose chart	K-8

Assembly equipment	Section L
Crimp machines	L-2
Hose preparation	L-14
Proof test stands	L-24
Contamination control products	L-26

Glossary and Index	Section M
Glossary	M-2
Index	M-6

Eaton Hydraulics' POWERSOURCE®

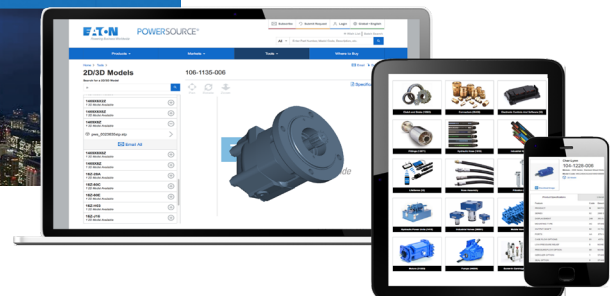
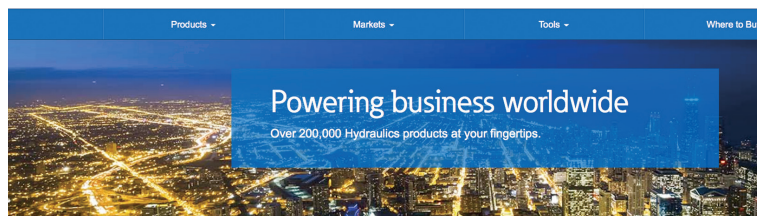

Anytime. Anywhere. Any Device.

Eaton's single-site digital customer experience empowers buyers and sellers of Eaton Hydraulic products across the globe in several languages. The power of **PowerSource** is now available to all users for optimal viewing – on any device, with one click:

www.EatonPowerSource.com

Visit www.EatonPowerSource.com

Important safety information

Assembly product warning and How to order

A

Eaton's Aeroquip Hose and Fitting Assembly Product Warning

Flexible hose lines offer many advantages over rigid tubing including routing ease, vibration absorption, sound deadening and the ability to accommodate movement of connected components. However, hose lines require caution in use not only to provide long service, but also to guard against potentially dangerous failure.

Important

The user should carefully observe the precautions listed in this catalog, including the recommendations on the selection of hose and fittings on the relevant pages, and the pages on fluid compatibility. In addition, care should be taken not to exceed the minimum bend radius listed for each hose size and type in the hose section. Maximum operating pressure should not exceed pressures listed in the hose data. Instructions for assembling fittings to different hose should be followed carefully to ensure the performance of the completed assembly.

⚠ WARNING Eaton fitting tolerances are engineered to match Eaton's Aeroquip hose tolerances. The use of Eaton fittings on hose supplied by other manufacturers and/or the use of Eaton's Aeroquip hose with fittings supplied by other manufacturers may result in the production of unreliable

and unsafe hose assemblies and is neither recommended nor authorized by Eaton or any of its affiliates or subsidiaries.

⚠ WARNING Application considerations must be observed in selecting appropriate components for the application of these products contained herein. The failure to follow the recommendations set forth in this catalog may result in an unstable application which may result in serious personal injury or property damage.

EATON OR ANY OF ITS AFFILIATES OR SUBSIDIARIES SHALL NOT BE SUBJECT TO AND DISCLAIMS ANY OBLIGATIONS OR LIABILITIES (INCLUDING BUT NOT LIMITED TO ALL CONSEQUENTIAL, INCIDENTAL AND CONTINGENT DAMAGES) ARISING FROM TORT CLAIMS (INCLUDING WITHOUT LIMITATION NEGLIGENCE AND STRICT LIABILITY) OR OTHER THEORIES OF LAW WITH RESPECT TO ANY HOSE ASSEMBLIES NOT PRODUCED FROM GENUINE AEROQUIP HOSE FITTINGS, HOSE AND AEROQUIP APPROVED EQUIPMENT, AND IN CONFORMANCE WITH EATON'S AEROQUIP PROCESS AND PRODUCT INSTRUCTIONS FOR EACH SPECIFIC HOSE ASSEMBLY.

Failure to follow these processes and product instructions and limitations could lead to premature hose assembly failures resulting in property damage, serious injury or death.

Routing

If the user follows the recommendations on hose line routing and installation as provided herein, improved safety and longer service life of any hose installation will result.

Hose Installation

Proper installation of the hose is essential to the proper operation and safe use of the hose and related equipment. Improper installation of the hose can result in serious injury or property damage caused by spraying fluids or flying projectiles. In order to avoid serious bodily injury or property damage resulting from improper installation of the hose, you should carefully review the information in this catalog regarding hose installation.

Some of the factors you must consider in installing the hose properly are:

- Changes in length
- Proper bend radius
- Protection from high temperature sources
- Elbows and adapters to relieve strain

- Rubbing or abrasion
- Twisting
- Improper hose movement

These factors and the other information in this catalog regarding hose installation should be considered by you before installing the hose. If you have any questions regarding proper hose installation, please contact Eaton Technical Support at 1-888-258-0222.

Hose Maintenance

Proper maintenance of the hose is essential to the safe use of the hose and related equipment. Hose should be stored in a dry place. Hose should also be visually inspected. Any hose that has a cut or gouge in the cover that exposes the reinforcement should be retired from service. Hoses should also be inspected for kinking or broken reinforcement. If the outside diameter of the hose is reduced by 20% at the spot where it is bent then the hose should be retired from service. Inadequate attention to maintenance of the hose can result in hose leakage, bursting, or other failure which can cause serious bodily injury or property damage from spraying fluids, flying projectiles, or other substances.

How to order

Accurate processing and prompt delivery of your order depends on easy identification of your requirements. Please order Aeroquip brand parts using correct part numbers as described in this catalog. Inquiries and orders should be directed to your Aeroquip distributor or:

Eaton
14615 Lone Oak Road
Eden Prairie, MN 55344
952-937-9800;
888-258-0222;
Fax: 952-974-7722
www.eaton.com/hydraulics

Part numbers and dash sizes

Dash size designates the nominal size in 16th of an inch. This number immediately follows the part number and is separated from it with a dash.

Dimensions

Dimensions given in this catalog for Aeroquip products are approximate and should be used for reference only. Exact dimensional information for a given product is subject to change and varying tolerances; contact Eaton directly for full current information.

⚠ WARNING

Hose assemblies

Eaton manufactures the terminal ends of our hose fittings to the appropriate requirements established by the SAE. Therefore, the performance ratings of these hose fittings meet the SAE requirements. It is possible to order a hose assembly with a fitting terminal end that has a performance rating lower than the hose rating. When ordering hose assemblies, please keep the

connecting end performance rating in mind since this may affect overall hose assembly performance. Hose assembly components (hose and fittings) are easily assembled in the field. However, factory assembled reusable and crimped hose assemblies are available. For complete information, contact Eaton.

Selection, installation and maintenance of hose and assemblies

The following recommendations on selection, installation and maintenance of hose assemblies were established by the SAE in 1991. Please read these general instructions carefully. More detailed information on many of these subjects is covered in this catalog.

1. Scope

Hose (also includes hose assemblies) has a finite life and there are a number of factors which will reduce its life. This recommended practice is intended as a guide to assist system designers and/or users in the selection, installation, and maintenance of hose.

The designers and users must make a systematic review of each application and then select, install, and maintain the hose to fulfill the requirements of the application. The following are general guidelines and are not necessarily a complete list.

⚠ Warning: improper selection, installation, or maintenance may result in premature failures, bodily injury, or property damage.

2. References

2.1 Applicable documents

The following publications form a part of this specification to the extent specified herein. The latest issue of SAE publications shall apply.

2.1.1 SAE publications

Available from SAE,
400 Commonwealth Drive,
Warrendale, PA 15096-0001.

J516—Hydraulic hose fittings

J517—Hydraulic hose

3. Selection

The following is a list of factors which must be considered before final hose selection can be made.

3.1 Pressure

After determining the system pressure, hose selection must be made so that the recommended maximum operating pressure is equal to or greater than the system pressure. Surge pressures higher than the maximum operating pressure will shorten hose life and must be taken into account by the hydraulic designer.

3.2 Suction

Hoses used for suction applications must be selected to insure the hose will withstand the negative pressure of the system.

3.3 Temperature

Care must be taken to insure that fluid and ambient temperatures, both static and transient, do not exceed the limitations of the hose. Special care must be taken when routing near hot manifolds.

3.4 Fluid compatibility

Hose selection must assure compatibility of the hose tube, cover and fittings with the fluid used. Additional caution must be observed in hose selection for gaseous applications.

3.5 Size

Transmission of power by means of pressurized fluid varies with pressure and rate of flow. The size of the components must be adequate to keep pressure losses to a minimum and avoid damage to the hose due to heat generation or excessive turbulence.

3.6 Routing

Attention must be given to optimum routing to minimize inherent problems.

3.7 Environment

Care must be taken to insure that the hose and fittings are either compatible with or protected from the environment to which they are exposed. Environmental conditions such as ultraviolet light, ozone, salt water, chemicals, and air pollutants can cause degradation and premature failure and, therefore, must be considered.

3.8 Mechanical loads

External forces can significantly reduce hose life. Mechanical loads which must be considered include excessive flexing, twist, kinking, tensile or side loads, bend radius, and vibration. Use of swivel-type fittings or adapters may be required to insure no twist is put into the hose. Unusual applications may require special testing prior to hose selection.

3.9 Abrasion

While hose is designed with a reasonable level of abrasion resistance, care must be taken to protect the hose from excessive abrasion which can result in erosion, snagging and cutting of the hose cover. Exposure of the reinforcement will significantly accelerate hose failure.

3.10 Proper end fitting

Care must be taken to insure proper compatibility exists between the hose and coupling selected based on the manufacturer's recommendations substantiated by testing to industry standards such as SAE J517. End fitting components from one manufacturer are usually not compatible with end fitting components supplied by another manufacturer (i.e., using a hose fitting nipple from one manufacturer with a hose socket from another manufacturer). It is the

responsibility of the fabricator to consult the manufacturer's written instructions or the manufacturer directly for proper end fitting componentry.

3.11 Length

When establishing proper hose length, motion absorption, hose length changes due to pressure, as well as hose and machine tolerances must be considered.

3.12 Specifications and standards

When selecting hose, government, industry and manufacturers' specifications and recommendations must be reviewed as applicable.

3.13 Hose cleanliness

Hose components vary in cleanliness levels. Care must be taken to insure that the assemblies selected have an adequate level of cleanliness for the application.

3.14 Electrical conductivity

Certain applications require that hose be nonconductive to prevent electrical current flow. Other applications require the hose to be sufficiently conductive to drain off static electricity. Hose and fittings must be chosen with these needs in mind.

4. Installation

After selection of proper hose, the following factors must be considered by the installer.

4.1 Pre-installation inspection

Prior to installation, a careful examination of the hose must be performed. All components must be checked for correct style, size and length. In addition, the hose must be examined for cleanliness, I.D. obstructions, blisters, loose cover, or any other visible defects.

Hose selection

General hose selection information

A

Selection, installation and maintenance of hose and assemblies

The following recommendations on selection, installation and maintenance of hose assemblies were established by the SAE in 1991. Please read these general instructions carefully. More detailed information on many of these subjects is covered in this catalog.

4.2 Follow manufacturers' assembly instructions

Hose assemblies may be fabricated by the manufacturer, an agent for or customer of the manufacturer, or by the user. Fabrication of permanently attached fittings to hydraulic hose requires specialized assembly equipment. Field attachable fittings (screw style and segment clamp style) can usually be assembled without specialized equipment although many manufacturers provide equipment to assist in the operation.

SAE J517 hose from one manufacturer is usually not compatible with SAE J516 fittings supplied by another manufacturer. It is the responsibility of the fabricator to consult the manufacturer's written assembly instructions or the manufacturers directly before intermixing hose and fittings from two manufacturers. Similarly, assembly equipment from one manufacturer is usually not interchangeable with that of another manufacturer. It is the responsibility of the fabricator to consult the manufacturer's written instructions or the manufacturer directly for proper assembly equipment. Always follow the manufacturer's instructions for proper preparation and fabrication of hose assemblies.

4.3 Minimum bend radius

Installation at less than minimum bend radius may significantly reduce hose life. Particular attention must be given to preclude sharp bending at the hose/fitting juncture.

4.4 Twist angle and orientation

Hose installations must be such that relative motion of machine components produces bending of the hose rather than twisting.

4.5 Securement

In many applications, it may be necessary to restrain, protect, or guide the hose to protect it from damage by unnecessary flexing, pressure surges, and contact with other mechanical components. Care must be taken to insure such restraints do not introduce additional stress or wear points.

4.6 Proper connection of ports

Proper physical installation of the hose requires a correctly installed port connection while insuring that no twist or torque is put into the hose.

4.7 Avoid external damage

Proper installation is not complete without insuring that tensile loads, side loads, kinking, flattening, potential abrasion, thread damage, or damage to sealing surfaces are corrected or eliminated.

4.8 System check out

After completing the installation, all air entrapment must be eliminated and the system pressurized to the maximum system pressure and checked for proper function and freedom from leaks.

Note: Avoid potential hazardous areas while testing.

5. Maintenance

Even with proper selection and installation, hose life may be significantly reduced without a continuing maintenance program. Frequency should be determined by the severity of the application and risk potential. A maintenance program should include the following as a minimum.

5.1 Hose storage

Hose products in storage can be affected adversely by temperature, humidity, ozone, sunlight, oils, solvents, corrosive liquids and fumes, insects, rodents and radioactive materials. Storage areas should be relatively cool and dark and free of dust, dirt, dampness and mildew.

5.2 Visual inspection

Any of the following conditions requires replacement of the hose:

- Leaks at fitting or in hose (leaking fluid is a fire hazard)
- Damaged, cut, or abraded cover (any reinforcement exposed)
- Kinked, crushed, flattened, or twisted hose
- Hard, stiff, heat cracked or charred hose
- Blistered, soft, degraded, or loose cover
- Cracked, damaged, or badly corroded fittings
- Fitting slippage on hose

5.3 Visual inspection

The following items must be tightened, repaired, or replaced as required:

- Leaking port conditions
- Clamps, guards, shields
- Remove excessive dirt buildup
- System fluid level, fluid type, and any air entrapment

5.4 Functional test

Operate the system at maximum operating pressure and check for possible malfunctions and freedom from leaks.

Note: Avoid potential hazardous areas while testing.

5.5 Replacement intervals

Specific replacement intervals must be considered based on previous service life, government or industry recommendations, or when failures could result in unacceptable down time, damage, or injury risk.

Numbering system



Numbering system

Cut length hose

Cut lengths of hose should be ordered as shown below by specifying lengths in inches.

For numeric part numbers:

2651- 10- 00484

Hose type _____

Hose size (in 16th of an inch) _____

Cut length (in inches) _____

last digit is in 1/8th of an inch 00484 = 48 1/2 inches

For alpha-numeric part numbers:

FC300- 08- 00484

Hose type _____

Hose dash size _____

Cut length (in inches) _____

last digit is in 1/8th of an inch 00484 = 48 1/2 inches

Bulk hose

Bulk hose should be ordered by specifying length in feet as shown below.

500 ft.- 2651- 10

Complete number quantity (in feet) _____

Hose type _____

Hose size (in 16ths of an inch) _____

Notes: Length tolerance for hose, assemblies and sleeves is:

Up to and including 12 inches: $\pm 1/8''$

Above 12 inches to and including 18 inches: $\pm 3/16''$

Above 18 inches to and including 36 inches: $\pm 1/4''$

Above 36 inches: $\pm 1\%$ of length

Hose selection

Agency listings

A

Agency listings

Government agencies

- DOT/FMVSS** US Department of Transportation, Federal Motor Vehicle Safety Standard
- FDA** US Food and Drug Administration (tubes only)
- MIL/DOD** US Military Specification, Dept. of Defense
- MSHA** US Mine Safety and Health Administration
- USCG/MMT** US Coast Guard, Merchant Marine Technical (SAE J1942 has replaced USCG approval)
- DNVGL** DNVGL (USA) WC
- CGA** Canadian Gas Association

Industry agencies

- AAR** American Association of Railroads
- DIN** Deutsche (German) Industrial Norme (Replaced by EN)
- EN** Committee for European Normalization
- ABS** American Bureau of Shipping
- SAE** Society of Automotive Engineers
- UL** Underwriters Laboratories
- ISO** International Standards Organization
- +** Approved details available from Eaton

The listings below are intended only as guides in identifying which Eaton Aeroquip® hoses comply with requirements of various agencies. For current and complete information, contact Eaton.

*Listing may vary by hose style and size, some hoses may require firesleeve or special procedures depending on specific applications, contact Eaton for details.

Hose part no.	Page	Government							Industry						
		DOT/FMVSS	CGA	DNVGL	FDA*	MIL/DOD	MSHA	USCG/SAE	ISO	EN	DIN	AAR	ABS	SAE	UL
1503	C-9	106 Type A II	-	+	-	-	-	+	-	-	-	+	+	100R5, J1402	-
1531	F-15	-	-	-	-	-	-	-	-	-	-	M618	-	-	-
15CA	F-5	106	-	-	-	-	-	-	-	-	-	-	-	SAE J844 Type B	-
2550	F-15	106 Type A II	-	-	-	-	-	-	-	-	-	-	-	J1402	-
2554	F-15	-	-	-	-	MIL-DTL-3992	-	-	-	-	-	-	-	J1402	-
2556	C-5	-	-	+	-	-	+	-	-	-	-	-	-	20R2 Type 1	-
2565	C-5	-	-	-	-	MIL-H-13444 Type I	-	-	-	-	-	-	-	20R2	-
2570	F-14	106 Type A II	-	-	-	-	-	-	-	-	-	-	-	J1402	-
2580	C-8	-	-	-	-	MIL-H-24136/3	+	+	-	-	-	-	-	-	-
2583	C-7	-	-	-	-	-	+	-	-	EN 854 Type R3	-	-	-	100R3	-
2651	C-10	-	-	+	-	-	+	+	-	-	-	-	+	100R5	-
2661	B-43	-	-	-	-	-	+	+	-	-	-	-	+	100R4	-
2681	B-29	-	-	+	-	-	+	+	1436 Type 1ST	EN 853 Type 1ST	20 022 Type 1ST	-	-	100R1A	-
2781	B-30	-	-	+	-	-	+	+	1436 Type 1ST	EN 853 Type 2ST	20 022 Type 2ST	-	+	100R2A	-
2807	G-8	-	-	+	-	-	-	+	-	-	-	-	+	100R14A	-
30CT	B-49,52	-	-	-	-	-	-	-	-	-	-	-	-	100R18	-
3130	B-44,52	-	-	-	-	-	-	+	-	-	-	-	-	100R7	-
3740	B-45	-	-	-	-	-	-	-	-	-	-	-	-	100R7	-
3E80	B-48	-	-	-	-	-	-	-	-	-	-	-	-	100R8	-
3R80	B-47	-	-	-	-	-	-	+	-	-	-	-	-	100R8	-
3SCE	F-5	106	-	-	-	-	-	-	-	-	-	-	-	J844 Type B	-
3V10	B-50	-	-	-	-	-	-	-	-	-	-	-	-	-	-
3VE0	B-51	-	-	-	-	-	-	-	-	-	-	-	-	-	-
35FH	F-13	-	-	-	-	-	-	-	-	-	-	-	-	J30R6, J30R9, J30R11, J1527B1	-
35NG	F-27	-	-	-	-	-	-	-	-	-	-	-	-	-	-
37AL	B-46,52	-	-	-	-	-	-	-	-	-	-	-	-	100R7	-

+ = Firesleeve required, contact Eaton for details

Agency listings

Hose part no.	Page	Government							Industry						
		DOT/FMVSS	CGA	DNVGL	FDA*	MIL/DOD	MSHA	USCG/SAE	ISO	EN	DIN	AAR	ABS	SAE	UL
3270	F-8	106	-	-	-	-	-	-	-	-	-	-	-	J844 Type B, J1131, J2494-3	-
4245	F-6	106	-	-	-	-	-	-	-	-	-	-	-	J844 Type A, J1131, J2494-3	-
4247	F-7	106	-	-	-	-	-	-	-	-	-	-	-	J844 Type A, J1131, J2494-3	-
4294	F-9	-	-	-	-	-	-	-	-	-	-	-	-	-	-
4297	F-10	-	-	-	-	-	-	-	-	-	-	-	-	-	-
8000	G-9	-	-	-	-	-	-	-	-	-	-	-	-	-	-
8500	G-9	-	-	-	-	-	-	-	-	-	-	-	-	-	-
CR170	F-26	-	Type III	-	-	-	-	-	-	-	-	-	-	-	UL21
EC230	B-35	-	-	-	-	-	-	-	-	-	-	-	-	100R2S	-
EC502	B-33	-	-	-	-	-	-	-	-	EN 853 Type 2SN	-	-	-	100R2S	-
EC525	B-16	-	-	-	-	-	+	-	-	-	-	-	-	-	-
EC600	B-20	-	-	+	-	-	+	+	18752-DC	-	-	-	+	100R15	-
EC810	B-19	-	-	-	-	-	+	-	-	-	-	-	-	-	-
EC850	B-21	-	-	-	-	-	-	-	18752	-	-	-	-	100R15	-
EC910	B-41	-	-	-	-	-	-	-	7751	EN1829	-	-	-	-	-
EH225	F-16	-	-	-	-	-	-	-	-	-	-	-	-	J20 R3 Class A	-
EH226	F-17	-	-	-	-	-	-	-	-	-	-	-	-	J20 R1 Class A	-
EH227	F-18	-	-	-	-	-	-	-	-	EN412, EN2240	-	-	-	J20 Class A	-
FC234	F-24	-	-	+	-	-	+	+	-	-	-	-	+	J1527 Type A1	-
FC254	B-36	-	-	+	-	-	+	+	-	EN 856 4SP	-	-	+	-	-
FC273B	B-18	-	-	-	-	-	-	-	3862 Type R13 18752	EN 856 Type R13	-	-	-	100R13	-
FC300	F-22	106 Type A II	-	+	-	-	-	+	-	-	-	-	-	100R5, J1019, J1402	-
FC310	B-26	-	-	-	-	-	+	+	-	EN 857 Type 1SC	-	-	-	-	-
FC321	F-25	-	-	-	-	-	-	-	-	-	-	-	-	-	UL21
FC332	C-4	-	-	-	-	-	-	+	-	-	-	-	+	-	-
FC350	F-21	106 Type A II	-	+	-	-	-	+	-	-	-	-	+	J1402	-
FC355	F-20	106 Type A II	-	-	-	-	-	-	-	-	-	-	-	J1402	-
FC466	C-7	-	-	-	-	-	-	-	-	EN 854 Type R6	-	-	-	100R6	-
FC498	C-6	-	-	-	-	-	+	-	-	EN 854 Type R6	-	-	-	100R6	-
FC500	B-17	-	-	-	-	-	+	-	18752	-	-	-	+	100R13	-
FC510	B-27	-	-	-	-	-	+	+	-	EN 857 Type 1SC	-	-	-	100R2	-
FC555	E-6	-	-	-	-	-	-	-	-	-	-	-	-	J2064	-
FC579	B-34	-	-	-	-	-	+	-	-	-	-	-	-	-	-

+ = Firesleeve required, contact Eaton for details

* Listing may vary by hose style and size, some hoses may require firesleeve or special procedures depending on specific applications, contact Eaton for details.

Hose selection

Agency listings

* Listing may vary by hose style and size, some hoses may require firesleeve or special procedures depending on specific applications, contact Eaton for details.

Agency listings

Hose part no.	Page	Government							Industry						
		DOT/FMVSS	CGA	DNVGL	FDA*	MIL/DOD	MSHA	USCG/SAE	ISO	EN	DIN	AAR	ABS	SAE	UL
FC598	C-6	-	-	-	-	-	-	-	-	-	-	-	-	100R6	-
FC606	B-38	-	-	-	-	-	+	-	-	-	-	-	+	100R15	-
FC611	B-31	-	-	-	-	-	-	-	-	-	-	-	-	-	-
FC619	B-42	-	-	-	-	-	+	-	18752	-	-	-	+	100R4	-
EC038	F-14	106 Type A II	-	-	-	-	-	-	-	-	-	-	-	J1402	-
FC636	B-40	-	-	-	-	-	-	-	-	-	-	-	-	100R12	-
FC639	B-22	-	-	-	-	-	+	-	-	-	-	-	-	100R17	-
FC647	C-4	-	-	-	-	-	-	-	-	-	-	-	-	-	-
FC650	F-23	-	-	-	-	-	-	-	-	-	-	-	-	-	-
FC693	B-32	-	-	-	-	-	-	-	-	-	-	-	-	-	-
FC699	F-23	-	-	-	-	-	-	-	-	-	-	-	-	-	-
FC735	B-11	-	-	+	-	-	-	-	11237-1 Type 2SC, 18752	1436 Type 2SN§	20 022 Type 2SN	‡	+	100R16	-
FC736	B-15	-	-	+	-	-	-	-	18752	3862 Type R12	EN856 Type R12	-	+	100R12	-
FC740	G-10	-	-	-	-	-	-	-	-	-	-	-	-	-	-
FC800	E-5	-	-	-	-	-	-	-	-	-	-	-	-	J2064	-
FC802	E-4	-	-	-	-	-	-	-	-	-	-	-	-	J51	-
FC839B	B-8	-	-	-	-	-	-	-	18752	-	-	-	-	100R17	-
FC849	B-24	-	-	-	-	-	+	+	-	-	-	-	+	100R19	-
FC849B	B-25	-	-	-	-	-	-	-	-	-	-	-	-	100R19	-
GH001	E-3	-	-	-	-	-	-	-	-	-	-	-	-	J2064 Type E	-
GH100	F-19	-	-	-	-	-	-	-	-	-	-	-	-	-	-
GH101	F-19	-	-	-	-	-	-	-	-	EN412, EN2240	-	-	-	-	-
GH120	B-13	-	-	-	-	-	+	-	-	EN 857 Type 2SC	-	-	-	100R16S	-
GH194	B-9	-	-	+	-	-	+	-	1436 Type 1SN	EN 853 Type 1SN	20 022 Type 1SN	-	+	100R1S	-
GH195	B-12	-	-	+	-	-	+	+	1436 Type 2SN	EN 853 Type 2SN	20 022 Type 2SN	-	+	100R2S	-
GH466	B-39	-	-	+	-	-	+	-	18752	EN 45545-2	-	-	+	100R15	-
GH493	B-14	-	-	-	-	-	+	-	3862 Type R12 18752	EN 856 TypeR12	-	-	+	100R12	-
GH506	B-37	-	-	+	-	-	+	-	3862 Type 4SH 18752	EN856 Type 4SH	20 023 Type T2	-	+	-	-
GH663	B-23	-	-	+	-	-	+	+	1436 Type 1SN	EN 853 Type 1SN	20 022 Type 1SN	-	+	100R1S	-
GH681	B-7	-	-	+	-	-	+	+	18752	EN 853 Type 1 SN	20 022 Type 1	-	+	-	-
GH781	B-10	-	-	+	-	-	+	-	11237-1 Type 2SC 18752	EN 857 Type 2SC	-	-	+	100R16S	-
GH793	B-28	-	-	+	-	-	+	+	1436 Type 2SN	EN 853 Type 2SN	20 022 Type 2SN	-	-	100R2S	-
H057	F-12	-	-	-	-	-	-	-	-	-	-	-	-	30R7	-
H201	C-3	-	-	-	-	-	+	-	-	-	-	-	-	-	-
S-Series	G-3	-	-	-	-	-	-	-	-	-	-	-	-	-	-
S-TW	G-5	-	-	+	-	-	-	-	-	-	-	-	-	100R14A	-
SC-Series	G-4	-	-	-	+	-	-	-	-	-	-	-	+	-	-
SC-TW Series	G-6	-	-	-	+	-	-	-	-	-	-	-	-	100R14B	-

+ = Firesleeve required, contact Eaton for details. ‡ = -4 thru -16 only.

Hose dash size to maximum operating pressure

Hose dash size to maximum operating pressure

This table is intended as a guide in the selection of hose by maximum operating pressure. It is not a guarantee. Final selection is further dependent on fluid and ambient temperature, concentration of fluid, intermittent or continuous exposure, etc. For further details on a specific hose see the respective catalog pages or contact Eaton.

Pressure expressed in PSI/BAR

† Pressure rating with reusable style fittings.

‡ Pressure rating with global crimp style fittings.

§ 10,000 psi for static jack hose applications.

See hose page for details.

* See hose page for dash sizes not listed.

†† 50 psi max with band clamp style fittings.

***Based on 2:1 safety factor.

Hose part number	Page	Tube	Hose -02	-03	-04	-05	-06	-08	-10	-12	-16	-20	-24	-32	-40	-48
EH225	F-16	5	-	-	100/7	75/5.3	62.5/4.3	62.5/4.3	62.5/4.3	50/3.5	43.8/3	-	-	-	-	-
EH226	F-17	5	-	-	-	270/18.6	265/18.3	218/15	199.3/13.8	191/13.2	174.8/12.1	154.3/10.6	130.3/9	105.5/7.6	94.8/6.5	79.3/5.5
2550	F-15	5	-	-	-	-	225/16	-	-	-	-	-	-	-	-	-
2554	F-15	5	-	-	-	-	225/16	-	-	-	-	-	-	-	-	-
2570	F-14	5	-	-	-	-	225/16	225/16	225/16	-	-	-	-	-	-	-
EC038	F-14	6	-	-	225/15.5	-	225/15.5	225/15.5	-	-	-	-	-	-	-	-
GH100	F-19	1	-	-	400/28	-	400/28	400/28	350/24	350/24	-	-	-	-	-	-
GH101	X															
FC647	C-4	1	-	-	360/25	-	300/21	300/21	250/17	250/17	-	-	-	-	-	-
2556	C-5	1	-	-	360/25	-	300/21	300/21	250/17	250/17	-	-	-	-	-	-
FC332	C-4	4	-	-	300/20	-	300/20	300/20	300/20	300/20	-	-	-	-	-	-
2565	C-5	1	-	-	300/21	-	250/17	200/14	175/12	125/8.5	-	-	-	-	-	-
1531	F-15	5	-	-	-	-	-	-	300/21	300/21	300/21	300/21	300/21	-	-	-
2661*	B-43	4	-	-	-	-	-	-	-	300/21†	250/17†	200/14†	150/10.5†	100/7†	62/4	62/4‡
FC619	B-42	1	-	-	-	-	-	-	-	300/21†	250/17†	200/14†	150/10.5†	100/7†	62/4	62/4
CR170	F-26	5	-	-	350/24	-	350/24	350/24	-	350/24	-	-	-	-	-	-
FC321	F-25	5	-	-	350/24	-	350/24	350/24	350/24	350/24	350/24	-	-	-	-	-
FC498	C-6	4	-	-	400/28	-	400/28	400/28	350/24	350/24	-	-	-	-	-	-
FC598	C-6	4	-	-	400/28	-	400/28	400/28	350/24	350/24	-	-	-	-	-	-
FC466	C-7	1	-	-	400/28	-	400/28	400/28	350/24	350/24	-	-	-	-	-	-
FC699	F-23	5	-	-	400/28	-	400/28	400/28	350/24	350/24	250/17	-	-	-	-	-
2580	C-8	1	-	-	1000/70	-	650/45	625/43	600/42	550/38	500/35	450/31	400/28	350/24	-	-
2583	C-7	1	-	-	1250/87	-	1125/78	1000/70	-	750/52	565/39	375/26	-	-	-	-
FC650	F-23	4	-	-	1000/70	-	1000/70	1000/70	1000/70	1000/70	-	-	-	-	-	-
FC355	F-20	4	-	-	1500/105	-	1500/105	1250/87	1250/87	750/52	400/28	300/21	250/17	200/14	-	-
FC234	F-24	5	-	-	-	1500/105	1500/105	1250/87	1250/87	750/52	750/52	-	-	-	-	-
FC350	F-21	4	-	-	2000/140	1500/105	1500/105	1250/87	1250/87	750/52	400/28	300/21	250/17	-	-	-
2807	G-8	2	-	3000/210	3000/210	3000/210	2500/175	2000/140	1500/105	1200/84	1000/70	625/43	-	-	-	-
S-TW	G-5	2	-	-	3000/207	3000/207	2500/172	2000/138	1750/121	1500/103	1000/68	-	-	-	-	-
FC300	F-22	4	-	-	3000/210	3000/210	2250/157	2000/140	1750/122	1500/105	800/56	500/35	500/34	300/21	300/21	-
FC611	B-31	6	-	-	-	-	2250/155	2000/138	-	1250/87	1000/70	625/43	500/35	375/26	-	-
1503	C-9	1	-	-	3000/210	3000/210	2250/157	2000/140	1750/122	1500/105	800/56	625/43	500/35	350/24	350/24	-
2651	C-10	1	-	-	3000/210	3000/210	2250/157	2000/140	1750/122	1500/105	800/56	625/43	500/35	350/24	350/24	-
FC639/ FC839B	B-22 B-8	1	-	-	3000/210	-	3000/210	3000/210	3000/210	3000/210	3000/210	-	-	-	-	-
GH681	B-7	1	-	-	3700/255	3250/225	3400/235	3200/221	2025/140	2000/138	1500/103	1000/69	750/52	600/41	-	-
GH194	B-9	4	-	-	3250/227	-	3000/210	2500/175	2000/140	1800/124	1300/90	900/62	725/50	580/40	-	-
GH663	B-23	1	-	-	3700/255†	-	3400/235†	2900/200†	-	2000/138†	1500/103†	1000/69	750/52	600/41	-	-
			-	-	2750/192	-	2250/157	2000/140	-	1250/87	1000/70	1000/69	750/52	600/41	-	-
EC810	B-19	1	-	-	-	-	-	-	-	6100/420	6100/420	6100/420	6100/420	5100/350	-	-
EC600	B-20	1	-	-	-	-	-	-	-	6100/420	6100/420	6100/420	6100/420	6100/420	-	-
EC502	B-33	1	-	-	-	-	-	4250/293	-	3125/215	2500/172	-	-	-	-	-
EC230	B-35	1	-	-	-	-	-	-	-	-	-	-	-	-	1150/79	-
FC740	G-10	2		3000/210	3000/210	3000/210	2500/175	2000/140	-	-	-	-	-	-	-	-
3130	B-44	3	2500/172	3000/207	3000/207	2500/172	2250/155	2000/138	-	1250/86	1000/69	-	-	-	-	-
2681	B-29	1	-	4000/280	3250/227	3250/227	3000/210	2500/175	2000/140	1800/124	1300/90	900/60	700/49	600/42	-	-
EC230	B-35	1	-	-	-	-	-	-	-	-	-	-	-	-	1150/79	-
FC849/ FC849B	B-24	1	-	-	4000/280	-	4000/280	4000/280	4000/280	4000/280	-	-	-	-	-	-
FC310	B-26	1	-	-	5000/350	-	4000/280	3500/245	2750/192	2250/157	2000/140	1625/113	-	-	-	-
FC693	B-32	6	-	-	5000/350	-	4000/280	3500/245	-	-	-	-	-	-	-	-
GH120	B-13	1	-	-	6000/414	-	5000/345	4500/310	4000/276	3500/241	2800/193	2300/159	2000/138	1500/103	-	-

Hose selection

Hose dash size to maximum operating pressure

Hose tube identification chart

1. Synthetic rubber
2. PTFE
3. Thermoplastic

4. AQP
5. Special application hose
6. EPDM

† Pressure rating with reusable style fittings.

‡ Pressure rating with global crimp style fittings.

§ 10,000 psi for static jack hose applications.

See hose page for details.

* See hose page for dash sizes not listed.

†† 50 psi max with band clamp style fittings.

***Based on 2:1 safety factor.

A

Hose part number	Page	Tube	Hose -02	-03	-04	-05	-06	-08	-10	-12	-16	-20	-24	-32	-40	-48
FC510	B-27	4	-	-	5000/350	-	4000/280	3500/245	2750/192	2250/157	2000/140	1625/1113			-	-
FC273(B)	B-18	1	-	-	-	-	-	-	-	5100/350	5100/350	5100/350	5100/350	5100/350	-	-
FC636	B-40	6	-	-	-	-	-	-	-	4000/275	4000/275	3000/207	2500/172	-	-	-
FC735	B-11	1	-	-	5000/345	-	5000/345	4275/295	3650/250	3125/215	2550/175	2250/155	-	-	-	-
FC736	B-15	1	-	-	-	-	5500/380	5000/345	5000/345	4050/280	4050/280	3050/210	2550/175	2550/175	-	-
2781	B-30	1	-	-	5000/345	-	4000/280	3500/241	2750/190	2250/155	2000/138	1625/112	1250/112	1125/78	-	-
			-	-	5800/400†	-	5000/345†	4300/295†	3650/250†	3100/215†	2550/175†	2250/155†	1800/125†	1300/90†	-	-
GH195	B-12	4	-	-	5800/400	-	5000/345	4250/293	3650/250	3125/215	2550/175	2550/155	1800/125	1525/105	-	-
GH781	B-10	1	-	-	6500/448	-	5300/366	4500/310	4000/276	3500/241	3000/207	2500/172	2000/138	1600/110	-	-
GH793	B-28	1	-	-	5000/350	-	4000/280	3500/245	2750/192	2250/157	2000/140	2500/172	2000/138	1600/110	-	-
			-	-	6500/448†	-	5800/400†	5000/345†	4000/276†	3500/241†	3000/207†	-	-	-	-	-
GH493	B-14	1	-	-	-	-	6500/448	6000/415	6000/415	5500/380	5100/350	4500/310	4000/275	4000/275	-	-
GH506	B-37	1	-	-	-	-	-	-	-	6100/420	5500/380	5100/350	4350/300	3650/250	-	-
FC500	B-17	1	-	-	-	-	-	-	-	5100/350	5100/350	5100/350	5100/350	5100/350	-	-
EC525	B-16	4	-	-	-	-	-	-	-	5000/345	5000/345	3500/240	3500/240	3250/225	-	-
FC254	B-36	1	-	-	-	-	-	7700/530	-	7200/497	6000/415	5100/350	4350/300	4000/275	-	-
GH466	B-39	1	-	-	-	-	-	-	-	-	-	6100/420	6100/420	6100/420	-	-
FC606	B-38	1	-	-	-	-	-	-	-	-	6100/420	6100/420	6100/420	-	-	-
EC850	B-21	1	-	-	-	-	-	-	7250/500	7250/500	7250/500	7250/500	-	-	-	-
FC579***	B-34	1	-	-	10000/690§	-	10000/690§	-	-	-	-	-	-	-	-	-
EC910	B-41	1	-	-	-	-	-	16000/1100	-	14500/1000	10000/690	-	-	-	-	-
3740	B-45	3	-	-	-	-	-	-	-	1250/86	1000/69	-	-	-	-	-
37AL	B-46	3	-	3000/207	2750/190	2500/172	2250/155	2250/155	-	-	-	-	-	-	-	-
3R80	B-47	3	-	5100/350	5100/350	-	4050/280	3550/245	-	2300/157	2050/140	-	-	-	-	-
3E80	B-48	3	-	5100/350	5100/350	-	4050/280	3550/245	-	2300/157	2050/140	-	-	-	-	-
30CT	B-49	3	-	3050/210	3050/210	3050/210	3050/210	3050/210	3050/210	-	-	-	-	-	-	-
3V10	B-50	3	-	10000/689	10000/689	-	8000/552	-	-	-	-	-	-	-	-	-
3VE0	B-51	3	-	10000/689	10000/689	-	8000/551	-	-	-	-	-	-	-	-	-
H201	C-3	5	-	-	300/21	300/21	300/21	300/21	300/21	300/21	200/14	-	-	-	-	-
GH001	E-3	5	-	-	500/35	-	500/35	500/35	500/35	500/35	500/35	-	-	-	-	-
FC802	E-4	5	-	-	500/35	-	500/35	500/35	500/35	500/35	-	-	-	-	-	-
FC800	E-5	5	-	-	-	-	-	-	-	500/35	500/35	500/35	500/35	-	-	-
FC555	E-6	5	-	-	-	-	-	-	-	500/35	500/35	500/35	-	-	-	-
H057	F-12	5	-	50/3.4	50/3.4	50/3.4	50/3.4	-	-	-	-	-	-	-	-	-
35FH	F-13	5	-	-	175/12	175/12	175/12	-	-	-	-	-	-	-	-	-
EH227	F-18	5	-	-	119.3/8.2	-	119.3/8.2	106.3/7.3	94/6.5	81.3/5.6	81.5/5.6	69/4.75	62.3/4.3	50/3.45	37.3/2.6	21.8/1.5
GH101	F-19	5	-	-	400/28	-	400/28	400/28	350/24	350/24	-	-	-	-	-	-
35NG	F-27	5	-	-	5000/345	-	5000/345	5000/345	-	-	-	-	-	-	-	-
NG-TW	G-28	5	-	-	-	-	435/30	435/30	435/30	-	-	-	-	-	-	-
S-Series	G-3	5	-	3500/241	3000/206	3000/206	2500/172	2000/137	1750/120	1500/103	1000/68	-	-	-	-	-
S-Series	G-3	5	-	-	-	-	-	-	-	-	1250/86	1000/68	-	-	-	-
S-Series	G-3	5	-	-	3000/206	-	2500/172	1500/103	-	1250/86	900/62	-	-	-	-	-
SC-Series	G-4	5	-	3500/241	3000/206	3000/206	2500/172	2000/137	1750/120	1500/103	1000/68	-	-	-	-	-
SC-Series	G-4	5	-	-	3000/206	-	2500/172	1500/103	-	1250/86	900/62	-	-	-	-	-
SC-TW	G-6	5	-	-	3000/207	3000/207	2500/172	2000/138	1750/121	1500/103	1000/69	-	-	-	-	-
SC-TW	G-6	5	-	-	3000/207	-	-	-	-	-	900/62	-	-	-	-	-
Hi-PSI	G-7	5	-	-	5000/345	-	5000/345	5000/345	5000/345	5000/345	5000/345	5000/345	4000/276	-	-	-
8000	G-9	5	-	-	-	-	-	1500/103	-	1250/86	900/62	900/62	750/52	500/35	-	-
8500	G-9	5	-	-	-	-	-	-	-	1250/86	900/62	900/62	750/52	500/35	-	-
FC611	B-31	6	-	-	-	-	-	-	-	1250/87	1000/70	625/43	500/35	375/26	-	-

Thread style pressure performance

Eaton closely follows industry standards in design and in application recommendations. A key principle within ISO, SAE and other standards bodies is that the **maximum dynamic working pressure of the hose or adapter assembly** is the lesser of the hose and end connector(s) used.

The first table below provides excerpts from standard industry pressure rating charts for connector types as published by SAE (Society of Automotive Engineers).

Note: The tables below are applicable for low carbon free machining steels typically used in Fluid Power connections. For port type connections, the material and design of the port must be considered and may reduce expected strength.

For high pressure applications Eaton recommends the use of more robust connector designs such as Code 62 flange or O-Ring face seal.

Selected SAE pressure ratings

Dash size	Inch size	37° JIC SAE J514	Pipe SAE J476	Male ORB SAE J1926 ORS adapt.	Male ORB SAE J1926 non-ORS adapt.	Adjustable ORB SAE J1926 ORS adapt.	Adjustable ORB SAE J1926 non-ORS adapt.	ORS SAE J1453	Male flareless SAE J514	Code 61 SAE J518	Code 62 SAE J518
-2	1/8	5000	5000	-	5000	-	5000	-	5000	-	-
-3	3/16	5000	-	9000	5000	6000	5000	-	5000	-	-
-4	1/4	4500	5000	9000	5000	6000	4500	9000	4500	-	-
-5	5/16	4000	-	9000	5000	6000	4500	9000	4000	-	-
-6	3/8	4000	4000	9000	5000	6000	4000	9000	4000	-	-
-8	1/2	4000	3000	9000	4500	6000	4000	9000	4000	5000	6000
-10	5/8	3000	-	9000	3500	6000	3000	6000	3000	-	-
-12	3/4	3000	2500	6000	3500	6000	3000	6000	3000	5000	6000
-14	7/8	2500	-	6000	3000	6000	2500	6000	2500	-	-
-16	1	2500	2000	6000	3000	5000	2500	6000	2500	5000	6000
-20	1 1/4	2000	1150	4000	2500	4000	2000	3600	2000	4000	6000
-24	1 1/2	1500	1000	4000	2500	3000	2000	3600	1500	3000	6000
-32	2	1125	1000	3000	2000	2500	1500	3000	1125	3000	6000

International pressure rating charts

Maximum working pressure (PSI)

Hose fitting connection	Hose fitting size									
	-04	-05	-06	-08	-10	-12	-16	-20	-24	-32
Male British Pipe (BSP)	5000	-	4000	4000	3500	4000	3500	2500	2,000	2000
Female British Pipe (BSP)	5000	-	4000	4000	3500	4000	3500	2500	2,000	2000
Female Pipe (JIS)	5000	-	5000	5000	-	4000	4000	-	-	-

Maximum working pressure (PSI)

Hose fitting Connection	Hose fitting size									
	-06	-08	-10	-12	-15	-18	-22	-28	-35	-42
DIN light	3625	3625	3625	3625	3625	2325	2325	1450	1450	1450

Hose selection

Hose fitting pressure charts

A

Hose fitting pressure charts

All Eaton components

With higher pressures it is critical to know the construction materials and manufacturing method to ensure performance. When all components in a system are

Eaton supplied, for example an Eaton hose fitting is mated with an Eaton adapter or tube fitting, the combination may be used at higher pressures with confidence.

These higher ratings are noted in the chart below.

Maximum dynamic working pressure of the hose or adapter assembly is the lesser of the hose and end connector(s) used.

All Eaton pressure ratings¹

Dash size	Inch size	37° JIC	Male pipe	Female pipe ²	Male ORB ORS adapter	Male ORB non-ORS adapter	Adjustable ORB ORS adap	Adjustable ORB non-ORS adapter	ORB	Male flareless	Code 61	Code 62	STC
-2	1/8	-	10000	6000	-	5000	-	5000	-	5000	-	-	-
-3	3/16	-	-	-	9000	5000	6000	5000	-	5000	-	-	-
-4	1/4	7000	9500	5000	9000	5000	6000	4500	9000	4500	-	-	6000
-5	5/16	7000	-	-	9000	5000	6000	4500	-	4000	-	-	-
-6	3/8	5000	8000	4000	9000	5000	6000	4000	9000	4000	-	-	5000
-8	1/2	4000	6000	4000	9000	4500	6000	4000	9000	4000	5000	6000	4250
-10	5/8	3800	-	-	9000	3500	6000	3000	9000	3000	-	-	4000
-12	3/4	3300	5000	3500	6000	3500	6000	3000	6000	3000	5000	6000	4000
-14	7/8	-	-	-	6000	3000	6000	2500	-	2500	-	-	-
-16	1	3500	4000	3000	6000	3000	5000	2500	6000	2500	5000	6000	4000
-20	1 1/4	2500	3000	2000	4000	2500	4000	2000	4500	2000	4000	6000	-
-24	1 1/2	2100	2000	1500	4000	2500	3000	2000	4000	1500	3000	6000	-
-32	2	1750	2000	1500	3000	2000	2500	1500	3000	1125	3000	6000	-

Note:

- 1) These ratings are based on both brazed and one piece construction, one-piece pressures could be increased. Please contact Eaton in these situations.
- 2) This rating is for thin walled adapters or fittings, the use of manifolds or oversized female ports would allow full rated male pressures.

Dynamic operating pressure

Dynamic operating conditions refers to cyclic pressure impulses, usually considered to be from near zero to the highest system pressure. Hydraulic standards typically represent these as square waves and expect a component to handle on the order of 200,000 to well over one million such cycles with a burst: operating safety factor of 4:1. The above charts are created with dynamic applications in mind. Most industrial and mobile hydraulic systems fit the dynamic operating pressure profile, for example hydraulic work circuits on construction equipment or on injection molding equipment.

Static operating pressure

Static operating conditions typically range from zero to operating pressure, but with far fewer cycles expected for the system life – perhaps 30,000 to 50,000 cycles and sharp pressure spikes are not expected, allowing a burst: operating safety factor of 3:1 or less. For static operating conditions, the Eaton ratings above can be safely increased by 25-30%. For example, a 3000 psi dynamic rated hose might be used in a 4000 psi static pressure application. Typical examples of static applications are water blast and hydraulic jacking.

Materials

The above tables represent performance using common low carbon steel material. Other materials and their

characteristics influence these ratings. Medium carbon steels or heat treated materials can support higher working pressures. Conversely non-ferrous materials such as aluminum or brass will have reduced capability – as much as 50%, or less, pressure handling capability. It is important to consider material properties in designing a system to ensure pressure rating compatibility of all materials.

Design & application

Eaton's Fluid Conveyance engineering and support teams have many decades of experience in designing, manufacturing and servicing hydraulic and other fluid conveyance systems globally. Eaton's product line is designed as a comprehensive collection of hose, fittings,

connectors, couplings and accessories that allow a system designer to select components to complete a fluid power system or a service technician to replace a component with confidence. The individual product specifications, the above pressure ratings and other technical information are intended as supporting guidelines for system design and service needs and are not to be construed as a guarantee of performance of the system or of individual Eaton components. Eaton provides comprehensive technical support so please call with questions about pressure needs not covered by these charts or for specific application support.

Fluid compatibility

This chart indicates the suitability of various elastomers and metals for use with fluids to be conveyed. It is intended as a guide only and is not a guarantee. Final selection of the proper hose style, seal, or material of metal components is further dependent on many factors including pressure, fluid and ambient temperature, concentration, duration of exposure, etc.

How to use the chart

1. The chart has separate sections for rating elastomers for use as hose inner tubes and as seals. Ratings for a given elastomer may not always be the same in both sections.
2. Both the elastomer and the metal must be considered when determining suitability of a combination for a hose assembly, adapter with o-ring, swivel joint or coupling.
3. Locate the fluid to be conveyed and determine the suitability of the elastomeric and metal components according to the resistance ratings shown for each.
4. Specific hose part numbers can be found under the inner tube material groupings in the Hose Tube Identification Chart.
5. Dimensional and operating specifications for each hose can be found on the catalog pages shown with each hose part number.
6. Information on o-rings and seal options for swivel joints and couplings, and how to specify them, are shown in the respective sections of this catalog.
7. For further details on the products shown in this catalog, and their applications, contact:

Eaton

14615 Lone Oak Road,
Eden Prairie, MN 55344
USA
952-937-9800
Fax: 952-974-7722
1-888-258-0222
www.eaton.com

Resistance key rating

E = Excellent – Fluid has little or no effect.

G = Good – Fluid has minor to moderate effect.

C = Conditional – Service conditions should be described to Eaton Aeroquip for determination of suitability for application.

U = Unsatisfactory

The differences between ratings “E” and “G” are relative. Both indicate satisfactory service. Where there is a choice, the materials rated “E” may be expected to give better or longer service than those rated “G”

NOTE: Special precautions are necessary in gaseous applications due to the potential volume of gaseous fluid in the system. Unless the cover is perforated, hose styles with rubber or thermoplastic covers are not suitable for gases above 250 psi. Hose styles with perforated covers are so noted in their construction descriptions.

⚠ WARNING: Compatibility of hose fittings with conveyed fluid is an essential factor in avoiding chemical reactions that may result in release of fluids or failure of the connection with the potential of causing severe personal injury or property damage.

Hose tube identification chart

1. Synthetic rubber

1503 (p.C-9)	EC502 (p.B-33)	FC579 (p.B-34)	FC849B (p.B-25)
2556 (p.C-5)	EC600 (p.B-20)	FC619 (p.B-42)	FC500 (p.B-17)
2565 (p.C-5)	EC850 (p.B-21)	FC639 (p.B-22)	GH120 (p.B-13)
2580 (p.C-8)	EC910 (p.B-41)	FC606 (p.B-38)	GH466 (p.B-39)
2583 (p.C-7)	EC810 (p.B-19)	FC647 (p.C-4)	GH493 (p.B-14)
2651 (p.C-10)	FC254 (p.B-36)	FC735 (p.B-11)	GH506 (p.B-37)
2681 (p.B-29)	FC273B (p.B-18)	FC736 (p.B-15)	GH663 (p.B-23)
2781 (p.B-30)	FC310 (p.B-26)	FC839B (p.B-8)	GH681 (p.B-7)
EC230 (p.B-35)	FC466 (p.C-7)	FC849 (p.B-24)	GH781 (p.B-10)
			GH793 (p.B-28)

2. PTFE

2807 (p.G-8)	S-TW (p.G-5)	FC740 (p.G-10)	S-Series (p.G-3)
SC-Series (p.G-4)	Hi-PSI (p.G-7)	8000 (p.G-9)	8500 (p.G-9)

3. Synflex thermoplastic elastomer

3E80 (p.B-48)	3VE0 (p.B-51)	30CT (p.B-49)	3130 (p.B-44)
3R80 (p.B-47)	3V10 (p.B-50)	37AL (p.B-46)	3740 (p.B-45)

4. AQP

2661 (p.B-43)	FC300 (p.F-22)	FC498 (p.C-6)	FC650 (p.F-23)
EC525 (p.B-16)	FC332 (p.C-4)	FC510 (p.B-27)	FC699 (p.F-23)
FC234 (p.F-24)	FC350 (p.F-21)	FC598 (p.C-6)	GH194 (p.B-9)
	FC355 (p.F-20)	FC598 (p.C-6)	GH195 (p.B-12)

5. Special application hose (not included in fluid chart)

Fuel	FC650 (p. G-5)	GH100 (p.F-19)	GH101 (p.F-19)	35FH (p.F-13)
LPG	FC321 (p. F-25)	35NG (p.F-27)	NG-TW (p.F-28)	CR170 (p.F-26)
Railroad air brake	1531 (p.F-15)			
Silicone	EH225 (p.F-16)	EH226 (p. F-17)	EH227 (p.F-18)	EC038 (p.F-14)
Truck air brake	2554 (p.F-15)	2570 (p. F-14)	FC350 (p.F-21)	
A/C	GH001 (p.E-3)	FC802 (p.E-4)	FC800 (p.E-5)	FC555 (p.E-6)

6. EPDM rubber

FC611 (p.B-31)	FC636 (p.B-40)	FC693 (p.B-32)	
----------------	----------------	----------------	--

Seal elastomer data

Seal elastomer	Application specification	Max. operating temperature range
Buna-N†	none	-40°C to +121°C [-40°F to +250°F]
Neoprene	none	-54°C to +100°C [-65°F to +212°F]
EPR (Ethylene Propylene Rubber)/EPDM	none	-54°C to +149°C [-65°F to +300°F]
Viton*	MIL-R-25897	-29°C to +204°C [-15°F to +400°F]

†Buna-N temperature range -65°F to +225°F. Also per MIL-R-6855.

*Viton is a trademark of The Chemours Company FC, LLC

E=Excellent
G=Good
C=Conditional
U=Unsatisfactory

Fluid	Synthetic rubber						Thermoplastic elastomer							Special application hose							Seals					Metal					
	PTFE		AQP		EPDM		Buna-N		Neoprene		EPR		Viton*		Urethane		Hytrej†		Steel		Brass		Stainless steel		Aluminum		Monel‡				
	1	2	3	4	5	6	1	2	3	4	5	6	1	2	3	4	5	6	1	2	3	4	5	6	1	2	3	4	5	6	
Trichlorethylene	U	E	U	U	-	U	U	U	U	U	E	U	U	U	U	U	U	U	U	E	G	E	E	E	U	E	G	E	E	E	
Tricresyl Phosphate	U	E	U	U	-	E	U	U	U	E	G	U	U	U	U	U	U	U	U	E	-	C	-	G							
Triethanolamine	G	E	U	G	-	E	E	U	E	U	U	U	U	U	U	U	U	U	U	E	U	E	E	E	U	E	E	E	E	E	
Tung Oil	E	E	C	C	-	U	G	G	U	E	U	U	U	U	U	U	U	U	U	E	G	E	E	E	E	E	E	E	E	E	
Turpentine	E	E	G	G	-	U	G	U	U	E	G	G	G	G	G	G	G	G	G	G	G	G	G	G	G	G	G	G	G	G	
Varnish	C	E	G	G	-	U	G	U	U	E	G	G	E	G	E	E	E	E	E	G	E	E	E	E	E	E	E	E	E	E	
Vinyl Chloride	U	E	U	U	-	U	U	U	U	E	U	U	U	U	U	U	U	U	U	E	U	C	E	E	E	E	E	E	E	E	
Water (to +150°F)	E	E	E	G	-	E	E	E	E	E	E	E	E	E	E	E	E	E	E	C	G	E	G	E	E	E	E	E	E	E	
Water (+151°F to +200°F)	C	E	U	C	-	E	E	E	E	E	E	U	U	U	U	U	U	U	U	C	G	E	G	E	E	E	E	E	E	E	
Water (+201°F to +350°F)	U	E	U	U	-	E	U	U	G	G	U	U	U	U	U	U	U	U	U	C	G	E	G	E	E	E	E	E	E	E	
Water Glycol	E	E	C	E	-	E	E	E	E	E	E	C	C	E	E	E	E	E	E	E	E	E	G	E	E	E	E	E	E	E	
Water Petroleum Emulsion ²	E	E	C	C	-	U	E	G	U	E	C	C	C	E	E	E	E	E	E	C	E	E	G	E	E	E	E	E	E	E	
Xylene	U	E	C	U	-	U	U	U	U	E	U	U	U	U	U	U	U	U	U	E	E	E	E	E	E	E	E	E	E	E	
Zinc Chloride, 10% aq	E	E	E	E	-	E	E	E	E	E	E	E	E	E	E	E	E	E	E	U	U	C	G	E	E	E	E	E	E		
Zinc Sulfate, 10% aq	E	E	-	E	-	E	E	E	E	E	-	-	U	C	G	C	G	E	E	U	U	C	G	E	E	E	E	E	E		

Resistance key rating

- E** = Excellent – Fluid has little or no effect.
- G** = Good – Fluid has minor to moderate effect.
- C** = Conditional – Service conditions should be described to Eaton Aeroquip for determination of suitability for application.
- U** = Unsatisfactory

Hydraulic fluids & lubricating oils

The following is a representative list of fluids and manufacturers. The fluids are grouped under generic “family” heads and arranged alphabetically. For each generic “family” listing we have included maximum fluid temperature recommendations for the six hose classifications on page A-15 (1 through 6). Two maximum fluid temperature ratings are listed under designations of “H” and “LP”. The “H” designation is for hydraulic service up to the maximum rated operating pressure of any particular hose in the classification. The “LP” designation is for low-pressure service such as lubricating oil systems or low-pressure hydraulic return lines. The letter “U” in the box indicates unsatisfactory resistance to the fluid type. Fluid temperature ratings are predicated on maximum allowable ambient temperatures as follows:

Classifications 1 and 3

(Synthetic rubber and thermoplastic elastomer)

“H” fluid temp. ratings: +140°F ambient

“LP” fluid temp. ratings: +180°F ambient

Classification 2 (PTFE)

“H” fluid temp. ratings: +400°F ambient

“LP” fluid temp ratings: +400°F ambient

Classification 4 (AQP)

“H” fluid temp. ratings: +160°F ambient

“LP” fluid temp. ratings: +250°F ambient

(If “H” fluid temperature is +225°F or less, allowable ambient temperature may be increased to +200°F)

Ambient temperatures in excess of those recommended, in conjunction with maximum fluid temperatures, can materially shorten the service life of the hose.

Caution: The fluid manufacturer’s recommended maximum operating temperature for any specific name brand fluid should be scrupulously observed by the user. These recommended temperatures can vary widely between name brands of different fluid compositions, even though they fall into the same generic “family” of fluids. Exceeding the manufacturer’s recommended maximum temperature can result in fluid breakdown, producing by-products that are harmful to elastomeric products, as well as other materials in the system. If a manufacturer’s recommended maximum temperature for his specific fluid is lower than that for the hose rating, it should take precedence over the hose rating for service usage.

This chart is intended for reference use only.
The information in this chart pertains strictly to material compatibility and is not intended to be used as an application guide. For information on specific applications not included in this catalog, please contact Eaton Aeroquip.

*Viton is a trademark of The Chemours Company FC, LLC.

†Hytrej is a registered trademark of E.I. du Pont.

‡Monel is a registered trademark of Special Metals Corporation group of Companies.

Note 1 - Rubber-covered hose must be perforated to allow gas to escape.

Note 2 - Due to the widely different additives in these fluids, testing should be done on the actual fluid being considered.

Hose selection

Fluid compatibility

A

Straight petroleum-base

Maximum fluid temperature recommendation.

See caution on page A-15 for maximum fluid temperatures and limiting ambient temperatures.

Hose classifications (see page. A-15)

	1	2	3	4
H	+200°F	+400°F	+200°F	+300°F
LP	+200°F	+450°F	+200°F	+300°F

Fluid name

Aircraft hydraulic oil AA	DTE oils	OC turbine oils	Union ATF Dexron
Ambrex oils	Duro		Union ATF type F
Arco A.T.F. Dexron	Duro AW	Peaco oils	Union C-2 fluid
Arco A.T.F. dDexron IV		Pennbell oils	Union C-P oil
Arco A.T.F. Yype F	EP hydraulic oils	Power-tran fluid	Union custom motor oil
Arco fleet motor	EP industrial oils		Union gas engine oil
Arco H.T.F. C-2 fluid	EP machine oils	Quadroil series	Union Guardol motor oil
Arco H.T.C. 100 fluid	Energol HL68		Union heavy duty motor oil
Arco 303 fluid	Energol HLP C68	Rando oils	Union hydraulic oil AW
ATF special	Etna oils	Rando oils HD	Union hydraulic tractor fluid
Automatic transmission fluid (Dexron)	Exxon ATF	Redind oils	Union premium motor oil
		Regal oils R & O	Union S-1 motor oil
Carnea oils	Factovis 52 – Conventional R & O hydraulic fluid	Rimula oils	Union special motor oil
Citgo amplex		Rotella oils	Union super motor oil
Citgo ATF, type F	Gulf harmony AW	Rotella T oils	Union torque correction fluid
Citgo ATF, Dexron	Gulf security AW	RPM Delo 200 motor oils	Union turbine oil
Citgo extra duty circulating oils mineral oil (Heavy duty) (R & O)	Glide	RPM Delo 300 motor oils	Union turbine Oil XD
Citgo motor oils	Hulburt 27 series	RPM Delo special motor oils	Union Unax
Citgo pacemaker series mineral oil (R & O)	Hydraulic series	Rubilene	Union Unax AW
Citgo pacemaker t series mineral oil (R & O)	Hydraulic oils	Shell brand	Union Unax R & O
Citgo pacemaker XD series mineral oil (Heavy duty) (R & O)	Hydroil series	Special motor oils	Union Unax RX
Citgo pacemaker XD series mineral oil (Heavy duty) (R & O)	Industron 53 – anti wear hydraulic fluid	Sun R & O oils	Union Unitec motor oil
Citgo sentry		Suntac HP oils	Univis J13
Citgo tractor hydraulic fluid	Lubrite motor 20W-40	Suntac WR oils	Univis J26
Conoco 303 fluid		Sunvis 700 oils	Univis P32
Custom motor oil	Mobil AFT 210	Sunvis 800 oils	Vactra oils
	Mobil AFT 220	Sunvis 900 oils	Vitrea oils
	Mobilfluid 62	Super hydraulic oils	
Dectol R & O oils	Mobilfluid 423	Supreme motor oils	Way lubricants
Delo 400 motor oils	Mobil hydraulic oils		
Delvac oils	Mobiloil special	Tellus oils	XD-3 motor oils
Delvac SHC	Mobiloil super 10W-40	Teresstic oils	
Delvac special 10W-30		Torque fluids	
Donax T oils	NUTO oils	Torque fluid 47	
		Torque fluid 56	
		Tractor hydraulic fluid	

Water and petroleum oil emulsion (fr)

Maximum fluid temperature recommendation.

See caution on page A-15 for maximum fluid temperatures and limiting ambient temperatures.

Hose classifications (see page. A-15)

	1	2	3	4
H	+200°F	+250°F	+150°F	+200°F
LP	+200°F	+250°F	+150°F	+200°F

Fluid name

Aqualube	Masol fire resistant fluid
Astrol #587	Meltran FR 900
	Mine guard
Chevron FR Fluid D	Mobilmet S122
Chrysler L-705	
Citgo pacemaker invert FR fluid	Penn drake hydraqua fluid
Conoco FR hydraulic fluid	Permamul FR
	Puro FR fluid
	Pyrogard C
Dasco IFR	Pyrogard D
Duro FR-HD	
	Quintolubric 957 series
Fire resistant hydrafluid	Quintolubric 958 series
Fire resistant hydraulic Fluid B	
FR 3110 hydraulic fluid (invert)	Regent hydrolube #670
Fyre-safe W/O	
	Safoil hydraulic fluid anti-wear
Gulf R & D FR fluid	Sinclair Duro FR-HD
	Solvac 1535G
Houghto-safe 5046	Staysol FR
Houghto-safe 5046W	SunSAFE F
HulSAFE 500	
Hy-chock oil	Union FR fluid
Hydrasol A	Union soluble oil HD
Ironsides #814-A	Veedol auburn FRH
Irus fluid 905	Veedol auburn FRH Concentrate
Kutwell 40	

Water and glycol solution

Maximum fluid temperature recommendation.

See caution on page A-15 for maximum fluid temperatures and limiting ambient temperatures.

Hose classifications (see page. A-15)

	1	2	3	4
H	+200°F	+250°F	+150°F	C
LP	+200°F	+250°F	+150°F	C

Fluid name

Chem-trend HF-18	Maxmul
Chem-trend HF-20	Maxmul FR
Chevron glycol FR fluids	Melsyn 200
Citgo glycol FR fluids	Melsyn glycol FR
Citgo glycol FR-20 XD	
Citgo pacemaker	Nyvac FR fluid
	Nyvac FR 200 fluid
	Nyvac 20 (WG)
Dasco FR 150	Nyvac 30 (WG)
Dasco FR 200	
Dasco FR 200 B	
Dasco FR 310	Park water glycol hydraulic fluid
	Pennzoil fluid FR 2X
Fyrguard 150	
Fyrguard 200	
Fyre-Safe 225	Quintolubric 700 series
Gulf FR fluid G-200	Santosafe W/G 15
Gulf FR fluid – G series	Santosafe W/G 20
	Santosafe W/G 30
Houghto-safe 271	Standard glycol FR #15
Houghto-safe 416	Standard glycol FR #20
Houghto-safe 520	Standard glycol FR #25
Houghto-safe 525	
Houghto-safe 616	Ucon hydrolube 150 CP
Houghto-safe 620	Ucon hydrolube 200 CP
Houghto-Safe 625	Ucon hydrolube 275 CP
Houghto-safe 640	Ucon hydrolube 300 CP
Hydra safe 620	Ucon hydrolube 550 CP
Hydra safe 625	Ucon hydrolube 900 CP
Hydraulic safety fluid 200	Ucon hydrolube 150 DB
Hydraulic safety fluid 300	Ucon hydrolube 275 DB
Hyspin AF-1	Ucon hydrolube 150 LT
Hyspin AF-2	Ucon hydrolube 200 LT
Hyspin AF-3	Ucon hydrolube 275 LT
	Ucon hydrolube 300 LT
	Ucon M-1
	Ucon hydrolube 200 NM
	Ucon hydrolube 300 NM

Hose selection

Fluid compatibility

A

Straight phosphate-ester (fr)

Maximum fluid temperature recommendation.

See caution on page A-15 for maximum fluid temperatures and limiting ambient temperatures.

Hose classifications (see page. A-15)

	1	2	3	4	6
H	U	+400°F	+200°F	U	200
LP	U	+400°F	+200°F	U	200

Fluid name

FR Fluids	Houghto-Safe 1010
Fyrquel 90	Houghto-Safe 1055
Fyrquel 150	Houghto-Safe 1115
Fyrquel 220	Houghto-Safe 1120
Fyrquel 300	Houghto-Safe 1130
Fyrquel 550	
Fyrquel 1000	Pyrogard 51
Fyrquel 150 R & O	Pyrogard 53
Fyrquel 220 R & O	Pyrogard 55
Fyrquel 550 R & O	
	Safetytex 215
Gulf FR Fluid P-37	Skydraul 500A
Gulf FR Fluid P-40	Skydraul 7000
Gulf FR Fluid P-43	
Gulf FR Fluid P-45	Univis P12
Gulf FR Fluid P-47	

Silicone oils

Maximum fluid temperature recommendation.

See caution on page A-15 for maximum fluid temperatures and limiting ambient temperatures.

Hose classifications (see page. A-15)

	1	2	3	4
H	+200°F	+400°F	+200°F	+300°F
LP	+250°F	+400°F	+200°F	+300°F

Fluid name

Dow Corning 200 Fluid (100CS)	Dow Corning 4-3600
Dow Corning QF1-2023	Dow Corning 3-3672

Ester blend turbine oils

Maximum fluid temperature recommendation.

See caution on page A-15 for maximum fluid temperatures and limiting ambient temperatures.

Hose classifications (see page. A-15)

	1	2	3	4
H	-	-	-	-
LP	+250°F	+450°F	+200°F	+300°F

Fluid name

Stauffer Jet I
Stauffer Jet II

Polyol-ester

Maximum fluid temperature recommendation.

See caution on page A-15 for maximum fluid temperatures and limiting ambient temperatures.

Hose classifications (see page. A-15)

	1	2	3	4
H	+150°F	+400°F	-	+150°F
LP	+200°F	+400°F	-	+250°F

Fluid name

Quintolubric 822 Series

Lubricant compatibility chart

Lubricant	Hose style			
	FC802	FC800	FC555	GH001
Mineral oil	Y	Y	Y	Y
PAG	Y	Y	Y	Y
Ester oil	Y	Y	Y	Y
Alkylbenzene	Y	Y	Y	C*

* Contact your Eaton or Eaton Tech Support for additional information.
Y = Compatible N = Non-compatible C=Conditional

Flow capacities of hose assemblies at suggested flow velocities

The chart below is designed and provided as an aid in the determination of the correct hose size.

Example: At 13 U.S. gallons per minute, what is proper hose size within the suggested velocity range for pressure lines?

Solution: Locate 13 U.S. gallons per minute in the left hand column and 10 feet per second in the right hand column (the center of the suggested velocity range for pressure lines). Lay a straightedge across the two points. The inside diameter is shown in the center column nearest the straight edge.

For suction hose, follow the same procedure except use suggested velocity range for pump inlet lines in the right hand column.

Based on formula

$$\text{Area (sq. in.)} = \frac{\text{G.P.M.} \times 0.3208}{\text{Velocity (FT./SEC.)}}$$

* Suggestions are for oils having a maximum viscosity of 315 S.S.U. at +100°F (+38°C) and operating at temperatures between +65°F and +155°F (+54°C to +69°C). Under certain conditions, velocities in pressure lines can be increased up to 25 feet per second. Contact Aeroquip® with specific information on your application.

Conversions

To convert U.S. gallons into Imperial gallons multiply U.S. gallons by 0.83267. Imperial gallons into U.S. gallons multiply Imperial gallons by 1.20095. U.S. gallons to liters multiply by 3.785. Liters to U.S. gallons, multiply by 0.2642.

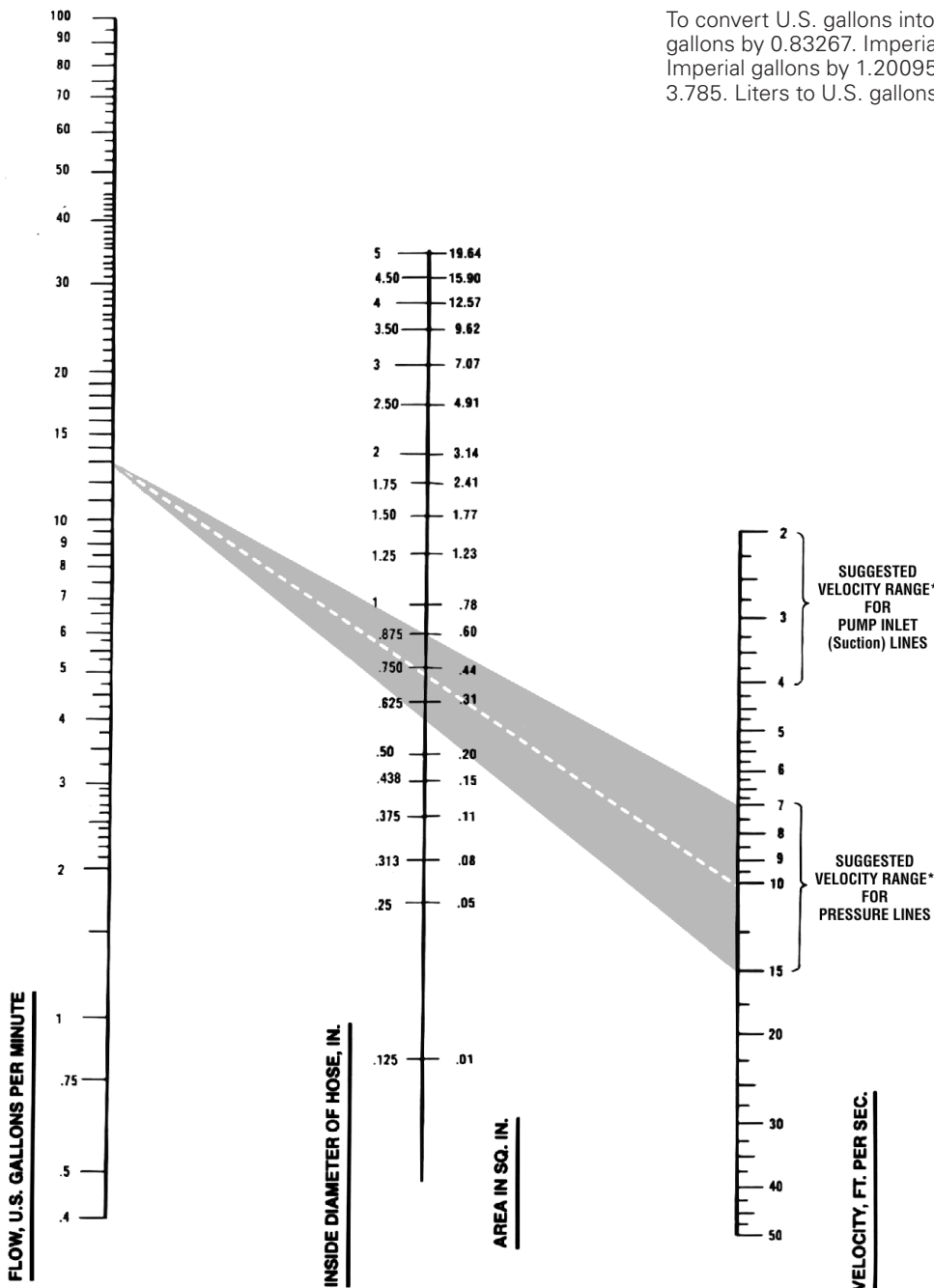

Hose selection

Flow capacities pressure drop

A

Flow capacities pressure drop

Pressure drop in psi (pounds per square inch)/gpm (gallons per minute) for 10 feet of hose (smooth bore) without fittings.

Fluid specification:
 Specific gravity = 0.85;
 Viscosity = ν =
 20 centistokes (C.S.),
 (20 C.S. = 97 S.S.U.).

Hose pressure drop

Hose dash size	-04	-05		-06		-08		-10		-12		-16		-20		-24		-32		-40	-48		
Hose I.D. (inches)	0.19	0.25	0.25	0.31	0.31	0.38	0.41	0.50	0.50	0.63	0.63	0.75	0.88	1.00	1.13	1.25	1.38	1.50	1.81	2.00	2.38	3.00	
0.25	10	3.1	3.1	-	-	-	-	-	-	-	-	-	-	-	-	-	-	-	-	-	-	-	-
0.50	19	6	6	2.7	2.7	-	-	-	-	-	-	-	-	-	-	-	-	-	-	-	-	-	-
1	40	12	12	5.5	5.5	2.4	-	-	-	-	-	-	-	-	-	-	-	-	-	-	-	-	-
2	95	24	24	10	10	4.8	3.5	-	-	-	-	-	-	-	-	-	-	-	-	-	-	-	-
3	185	46	46	17	17	7	5	2.2	2.2	-	-	-	-	-	-	-	-	-	-	-	-	-	-
4	-	78	78	29	29	12	8	3	3	1.2	1.2	-	-	-	-	-	-	-	-	-	-	-	-
5	-	120	120	44	44	18	12	4.5	4.5	1.6	1.6	0.72	-	-	-	-	-	-	-	-	-	-	-
8	-	-	-	95	95	39	26	10	10	3.6	3.6	1.4	0.60	-	-	-	-	-	-	-	-	-	-
10	-	-	-	-	-	59	40	15	15	5.7	5.7	2	1	0.55	-	-	-	-	-	-	-	-	-
12	-	-	-	-	-	80	52	20	20	7.2	7.2	2.6	1.5	0.75	0.43	-	-	-	-	-	-	-	-
15	-	-	-	-	-	-	75	30	30	10	10	4.2	2.2	1.2	0.67	0.38	-	-	-	-	-	-	-
18	-	-	-	-	-	-	107	40	40	15	15	6.3	3	1.5	0.70	0.55	0.35	-	-	-	-	-	-
20	-	-	-	-	-	-	-	49	49	19	19	8	3.4	2	1.1	0.65	0.43	0.27	-	-	-	-	-
25	-	-	-	-	-	-	-	72	72	26	26	11	5.5	3	1.6	1	0.64	0.40	0.17	-	-	-	-
30	-	-	-	-	-	-	-	-	-	34	34	14	7	3.6	2.2	1.3	0.80	0.52	0.22	0.14	-	-	-
35	-	-	-	-	-	-	-	-	-	47	47	19	9.5	5	2.8	1.7	1.1	0.70	0.27	0.18	-	-	-
40	-	-	-	-	-	-	-	-	-	-	-	25	12	6.5	3.4	2.2	1.4	0.90	0.38	0.24	-	-	-
50	-	-	-	-	-	-	-	-	-	-	-	36	17	9	5.3	3.3	2	1.3	0.54	0.35	0.15	-	-
60	-	-	-	-	-	-	-	-	-	-	-	50	23	12	7.5	4.4	2.8	1.8	0.75	0.45	0.20	-	-
70	-	-	-	-	-	-	-	-	-	-	-	-	31	17	9.3	6	3.8	2.4	1	0.65	0.30	-	-
80	-	-	-	-	-	-	-	-	-	-	-	-	38	21	12	7.1	4.6	3	1.2	0.76	0.34	0.11	-
90	-	-	-	-	-	-	-	-	-	-	-	-	49	27	15	9	5.9	3.8	1.5	1	0.45	0.13	-
100	-	-	-	-	-	-	-	-	-	-	-	-	-	33	19	12	7	4.7	1.9	1.3	0.55	0.18	-
150	-	-	-	-	-	-	-	-	-	-	-	-	-	60	36	22	13	8.5	3.4	2.2	1	0.33	-
200	-	-	-	-	-	-	-	-	-	-	-	-	-	-	-	36	23	15	6	3.9	1.7	0.55	-
250	-	-	-	-	-	-	-	-	-	-	-	-	-	-	-	54	33	22	8.5	5.3	2.5	0.75	-
300	-	-	-	-	-	-	-	-	-	-	-	-	-	-	-	-	45	29	12	7.5	4	1.1	-
400	-	-	-	-	-	-	-	-	-	-	-	-	-	-	-	-	-	51	21	14	6.5	2.2	-
500	-	-	-	-	-	-	-	-	-	-	-	-	-	-	-	-	-	-	32	20	10	3	-
800	-	-	-	-	-	-	-	-	-	-	-	-	-	-	-	-	-	-	-	-	18	5	-
1000	-	-	-	-	-	-	-	-	-	-	-	-	-	-	-	-	-	-	-	-	-	10	-

* Pressure drop values listed are typical of many petroleum based hydraulic oils at approximately +100°F (+38°C). Differences in fluids, fluid temperature and viscosity can increase or decrease actual pressure drop compared to the values listed.

To convert

To convert U.S. gallons into Imperial gallons multiply U.S. gallons by 0.83267. Imperial gallons into U.S. gallons multiply Imperial gallons by 1.20095. U.S. gallons to litres multiply by 3.785. Litres to U.S. gallons, multiply by 0.2642.

Hose routing and installation

1. Provide for length change.

In straight hose installations, allow enough slack in the hose line to provide for changes in length that will occur when pressure is applied. This change in length can be from +2% to -4%.

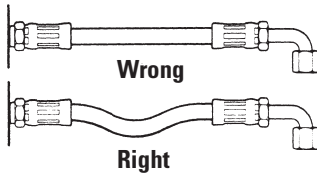

2. Avoid twisting and orient properly.

Do not twist hose during installation. This can be determined by the printed layline on the hose. Pressure applied to a twisted hose can cause hose failure or loosening of connections.

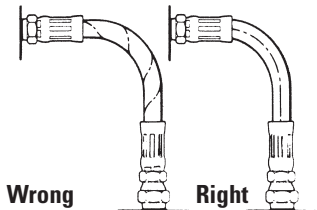

3. Protect from hazardous environment.

Keep hose away from hot parts. High ambient temperature will shorten hose life. If you can not route it away from the heat source, insulate it. (See Spring Guards page K-2)

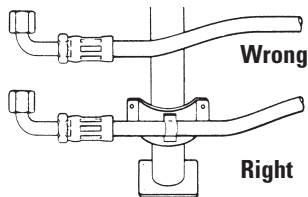

4. Avoid mechanical strain.

Use elbows and adapters in the installation to relieve strain on the assembly and to provide easier and neater installations that are accessible for inspection and maintenance.

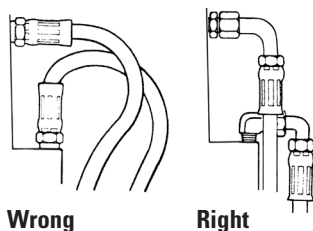

5. Use proper bend radius.

Keep the bend radius of the hose as large as possible to avoid collapsing of the hose and restriction of flow. Follow catalog specs on minimum bend radii.

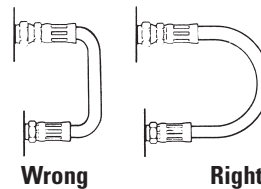

6. Use proper bend radius (cont'd).

Minimum bend radius is measured on the inside bend of the hose. To determine minimum bend, divide the total distance between ends (B length) by 2. For example, B=6, minimum bend radius=3.

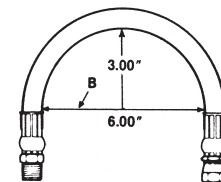

7. Secure for protection.

Install hose runs to avoid rubbing or abrasion. Use Aeroquip Hose Clamps to support long runs of hose or to keep hose away from moving parts. It is important that the clamps not allow the hose to move. This movement will cause abrasion and premature hose failure.

See Hose Clamps page K-5.

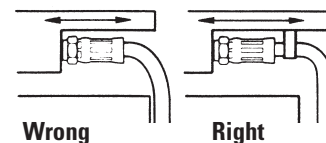

8. Avoid improper hose movement.

Make sure relative motion of the machine components produces bending rather than twisting of the hose. Hose should be routed so that the flex is in the same plane as the equipment movement.

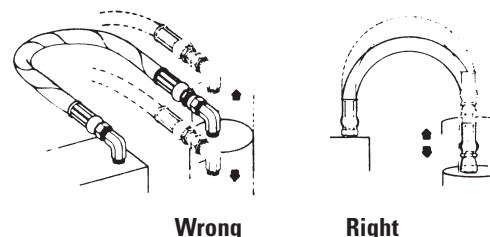

 Refer to safety information regarding hose installation on pages A-2 and A-3.

Hose selection

Analyzing failures

A

Analyzing failures

Everyone in maintenance encounters hose failures. Normally, there is no problem. The hose is replaced and the equipment goes back in operation. Occasionally the failures come too frequently – the same equipment with the same problems keep popping up. At this point the task is to determine and correct the cause of these repeated failures.

Improper application

Beginning with the most obvious, the most common cause of hose failures – Improper application – compare the hose specifications with the requirements of the application.

Pay particular attention to the following areas:

- The maximum operating pressure of the hose.
- The recommended temperature range of the hose.
- Whether the hose is rated for vacuum service.
- The fluid compatibility of the hose.

Check all of these areas against the requirements of the application. If they don't match up, you need to select another hose. It's a good idea at this point to call on your local hose distributor for assistance in selecting the proper hose. Eaton's distributors, for example, are well equipped to perform this service for you.

Distributor personnel attend special training courses in hydraulics and hose application conducted by the company. Or, if your problem is particularly difficult, the distributor can call on the services of Eaton's field engineering staff. The company will send in a hose and hydraulic specialist to study the problem and come up with a solution.

Improper assembly and installation

The second major cause of premature hose failure is improper assembly and installation procedures. This can involve anything from using the wrong fitting on a hose, to poor routing of the hose.

Eaton provides excellent training material that you can use to combat this problem. A little time spent in training your maintenance people could pay big dividends in reduced downtime.

You can make use of the material available from Eaton to improve your hose assembly and installation techniques.

This material is available free from

Eaton Corporation
14615 Lone oak road,
Eden prairie, MN 55344
USA, 952/937-9800.

External damage

External damage can range from abrasion and corrosion, to hose that is crushed by a lift truck. These are problems that can normally be solved simply once the cause is identified. The hose can be re-routed or clamped, or a fire sleeve or abrasion guard can be used.

In the case of corrosion, the answer may be as simple as changing to a hose with a more corrosion resistant cover or re-routing the hose to avoid the corrosive element.

Faulty equipment

Too frequent or premature hose failure can be the symptom of a malfunction in your equipment. This is a factor that should be considered since prompt corrective action can sometimes avoid serious and costly equipment breakdown. Reprints of an article on "Troubleshooting hydraulic systems," which tells you how to spot problems in a hydraulic system are available from Eaton.

Faulty hose

Occasionally a failure problem will lie in the hose itself. The most likely cause of a faulty rubber hose is old age. Check the lay line on the hose to determine the date of manufacture. (2Q99 means second quarter 1999.) The hose may have exceeded its recommended shelf life. If you suspect that the problem lies in the manufacture of the hose (and don't jump to this conclusion until you have exhausted the other possibilities) contact your distributor. Given effective quality control methods, the odds of a faulty batch of hose being released for sale are extremely small. So make sure that you haven't overlooked some other problem area.

Analyzing failures

A physical examination of the failed hose can often offer a clue to the cause of the failure. Following are 22 symptoms to look for along with the conditions that could cause them:

1. Symptom: The hose tube is very hard and has cracked.



Cause: Heat has a tendency to leach the plasticizers out of the tube. This is a material that gives the hose its flexibility or plasticity.

Aerated oil causes oxidation to occur in the tube. This reaction of oxygen on a rubber product will cause it to harden. Any combination of oxygen and heat will greatly accelerate the hardening of the hose tube. Cavitation occurring inside the tube would have the same effect.

2. Symptom: The hose is cracked both externally and internally but the elastomeric materials are soft and flexible at room temperature.



Cause: The probable reason is intense cold ambient conditions while the hose was flexed. Most standard hoses are rated to -40°F (-40°C). Some AQP hoses are rated at -55°F (-49°C). Military specified hoses are generally rated to -65°F (-54°C). PTFE hose is rated to -100°F (-73°C). Some Everflex Polyon thermoplastic hoses are rated at -65°F (-54°C).

3. Symptom: The hose has burst and examination of the wire reinforcement after stripping back the cover reveals random broken wires the entire length of the hose.



Cause: This would indicate a high frequency pressure impulse condition. SAE impulse test requirements for a double wire braid reinforcement are 200,000 cycles at 133% of recommended working pressure. The SAE impulse test requirements for a four spiral wrapped reinforcement (100R12) are 500,000 cycles at 133% maximum operating and at $+250^{\circ}\text{F}$ (121°C). If the extrapolated impulses in a system amount to over a million in a relatively short time a spiral reinforced hose would be the better choice.

Analyzing failures

4. Symptom: The hose has burst, but there is no indication of multiple broken wires the entire length of the hose. The hose may have burst in more than one place.



Cause: This would indicate that the pressure has exceeded the minimum burst strength of the hose. Either a stronger hose is needed or the hydraulic circuit has a malfunction which is causing unusually high pressure conditions.

5. Symptom: Hose has burst. An examination indicates the wire braid is rusted and the cover has been cut, abraded or deteriorated badly.



Cause: The primary function of the cover is to protect the reinforcement. Elements that may destroy or remove the hose covers are:

1. Abrasion
2. Cutting
3. Battery acid
4. Steam cleaners
5. Chemical cleaning solutions
6. Muriatic acid (for cement clean-up)
7. Salt water
8. Heat
9. Extreme cold

Once the cover protection is gone the wire reinforcement is susceptible to attack from moisture or other corrosive matter.

6. Symptom: Hose has burst on the outside bend and appears to be elliptical in the bent section. In the case of a pump supply line, the pump is noisy and very hot. The exhaust line on the pump is hard and brittle.

Cause: Violation of the minimum bend radius is most likely the problem in both cases. Check the minimum bend radius and make sure that the application is within specifications. In the case of the pump supply line partial collapse of the hose is causing the pump to cavitate creating both noise and heat. This is a most serious situation and will result in catastrophic pump failure if not corrected.

7. Symptom: Hose appears to be flattened out in one or two areas and appears to be kinked. It has burst in this area and also appears to be twisted.



Cause: Torquing of a hydraulic control hose will tear loose the reinforcement layers and allow the hose to burst through the enlarged gaps between the braided plaits of wire strands. Use swivel fittings or joints to be sure there is no twisting force on a hydraulic hose.

8. Symptom: Hose type has broken loose from the reinforcement and piled up the end of the hose. In some cases it may protrude from the end of the hose fitting.

Cause: The probable cause is high vacuum or the wrong hose for vacuum service. No vacuum is recommended for double wire braid, 4 and 6 spiral wire hose unless some sort of internal coil support is used. Even though a hose is rated for vacuum service, if it is kinked, flattened out or bent too sharply this type of failure may occur.

9. Symptom: Hose has burst about six to eight inches away from the end fitting. The wire braid is rusted. There are no cuts or abrasions of the outer cover.

Cause: Improper assembly of the hose end fitting allowing moisture to enter around the edge of the fitting socket. The moisture will wick through the reinforcement. The heat generated by the system will drive it out around the fitting area but six to eight inches away it will be entrapped between the inner line and outer cover causing corrosion of the wire reinforcement.

10. Symptom: There are blisters in the cover of the hose. If one pricks the blisters, oil will be found in them.

Cause: A minute pin hole in the hose tube is allowing the high pressure oil to seep between it and the cover. Eventually it will form a blister wherever the cover adhesion is weakest. In the case of a screw together reusable fitting insufficient lubrication of the hose and fitting can cause this condition because the dry tube will adhere to the rotating nipple and tear enough to allow seepage. Faulty hose can also cause this condition.

11. Symptom: Blistering of the hose cover where a gaseous fluid is being used.

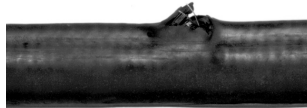

Cause: The high pressure gas is effusing through the hose tube, gathering under the cover and eventually forming a blister wherever the adhesion is weakest. Specially constructed hoses are available for high pressure gaseous applications. Your supplier can advise you on the proper hose to use in these cases.

12. Symptom: Fitting blew off of the end of the hose.

Cause: It may be that the wrong fitting has been put on the hose. Recheck manufacturer's specifications and part numbers. In the case of a crimped fitting the wrong machine setting may have been used resulting in over or under crimping. The socket of a screw together fitting for multiple wire braided hose may be worn beyond its tolerance. The swaging dies in a swaged hose assembly may be worn beyond the manufacturer's tolerances. The fitting may have been applied improperly to the hose. Check manufacturer's instructions. The hose may have been installed without leaving enough slack to compensate for the possible 4% shortening that may occur when the hose is pressurized. This will impose a great force on the fitting. The hose itself may be out of tolerance.

13. Symptom: The tube of the hose is badly deteriorated with evidences of extreme swelling. In some cases the hose tube may be partially "washed out."

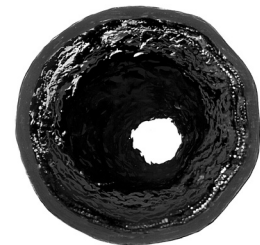

Cause: Indications are that the hose tube is not compatible with the agent being carried. Even though the agent is normally compatible, the addition of heat can be the catalyst that can cause inner liner deterioration. Consult your hose supplier for a compatibility list or present him with a sample of the fluid being conducted by the hose for analysis. Make sure that the operating temperatures both internal and external do not exceed recommendations.

Hose selection

Analyzing failures

A

Analyzing failures

14. Symptom: Hose has burst. The hose cover is badly deteriorated and the surface of the rubber is crazed.

Cause: This could be simply old age. The crazed appearance is the effect of weathering and ozone over a period of time. Try to determine the age of the hose. Some manufacturers print or emboss the cure date on the outside of the hose. As an example, Aeroquip hose would show "4Q01" which would mean that the hose was manufactured during the fourth quarter (October, November or December) of 2001.

15. Symptom: Hose is leaking at the fitting because of a crack in the metal tube adjacent to the braze on a split flange head.

Cause: Because the crack is adjacent to the braze and not in the braze this is a stress failure brought on by a hose that is trying to shorten under pressure and has insufficient slack in it to do so. We have cured dozens of these problems by lengthening the hose assembly or changing the routing to relieve the forces on the fitting.

16. Symptom: A spiral reinforced hose has burst and literally split open with the wire exploded out and badly entangled.



Cause: The hose is too short to accommodate the change in length occurring while it is pressured.

17. Symptom: Hose is badly flattened out in the burst area. The tube is very hard down stream of the burst but appears normal up stream of the burst.



Cause: The hose has been kinked either by bending it too sharply or by squashing it in some way so that a major restriction was created. As the velocity of the fluid increases through the restriction the pressure decreases to the vaporization point of the fluid being conveyed. This is commonly called cavitation, and causes heat and rapid oxidation to take place which hardens the tube of the hose down stream of the restriction.

18. Symptom: Hose has not burst but it is leaking profusely. A bisection of the hose reveals that the tube has been gouged through to the wire braid for a distance of approximately two inches.

Cause: This failure would indicate that erosion of the hose tube has taken place. A high velocity needle like fluid stream being emitted from an orifice and impinging at a single point on the hose tube will hydraulically remove a section of it. Be sure that the hose is not bent close to a port that is orificed. In some cases where high velocities are encountered particles in the fluid can cause considerable erosion in bent sections of the hose assembly.

19. Symptom: The hose fitting has been pulled out of the hose. The hose has been considerably stretched out in length. This may not be a high pressure application.

Cause: Insufficient support of the hose. It is very necessary to support very long lengths of hose, especially if they are vertical. The weight of the hose along with the weight of the fluid inside the hose in these cases is being imposed on the hose fitting. This force can be transmitted to a wire rope or chain by clamping the hose to it much like the utilities support bundles of wire from pole to pole. Be sure to leave sufficient slack in the hose between clamps to make up for the possible 4% shortening that could take place when the hose is pressurized.

20. Symptom: The hose has not burst but it is leaking profusely. An examination of the bisected hose reveals that the tube has burst inwardly.

Cause: This type of failure is commonly referred to as hose tube blow down. It is usually associated with very low viscosity fluids such as air, nitrogen, freon and other gases. What happens is that under high pressure conditions the gases will effuse into the pores of the hose tube charging them up like miniature accumulators. If the pressure is very suddenly reduced to zero the entrapped gases literally explode out of the tube often tearing holes in it. In some hose constructions a second hose tube made from a plastic such as nylon, is inserted into the hose.

A small leak will allow the gaseous fluid to seep between the two inner liners and when pressure is reduced to zero the innermost liner will collapse because the entrapped pressure around its inner diameter.

21. Symptom: PTFE hose assembly has collapsed internally in one or more places.

Cause: One of the most common causes for this is improper handling of the PTFE assembly. PTFE is a thermoplastic material which is not rubber-like. When bent sharply it simply collapses. This type of collapse is localized in one area and is radical. When the PTFE tube is folded longitudinally in one or more places this could be the result of heat (which softens the hose) along with vacuum conditions inside of it. Because of the additional tension of the wire braid, reinforcement inherent with this type of hose, there is always a radial tension on the tube trying to push it in. Rapid cycling from a very hot agent in the hose to a very cold agent in the hose can produce the same type of failure. Eaton Aeroquip offers an internal support coil that will eliminate this problem.

22. Symptom: A PTFE hose assembly has developed a pin hole leak or several pin hole leaks.

Cause: This situation occurs when a petroleum based fluid, with low viscosity, is flowing at high velocity. This condition can generate high voltage use to static electricity. The high voltage is seeking a ground connection and the only ground connection available is the braided stainless steel reinforcement. This causes an electric arc, which penetrates through the PTFE tube as it travels to the reinforcement. Specially constructed PTFE tubes are available that have enough carbon black in them so as to be conductive. They will "drain off" the static electricity and preclude this problem.

Fluid connectors identification

Measuring Tools: A seat angle gauge, thread pitch gauge and an I.D./O.D. caliper are necessary to make accurate measurements of commonly used connectors. Eaton offers a unique new caliper than offers the capabilities of both a caliper and a seat angle gauge in one unit.



FT1341

Identification Tool Kit

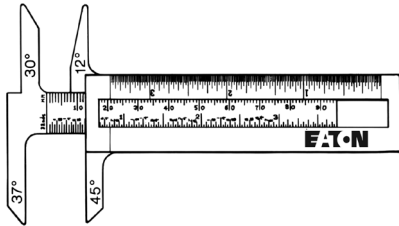

I.D./O.D. Angle gauge caliper

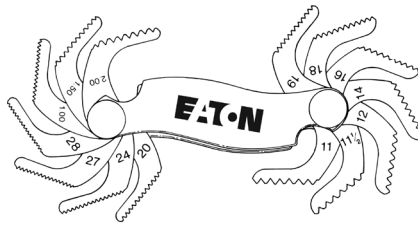

Thread pitch gauge

How to measure threads

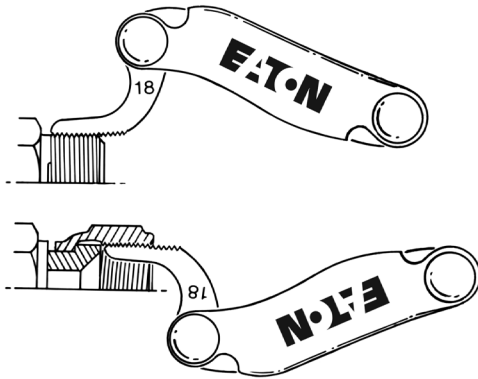

Use a thread pitch gauge to determine the number of threads per inch or the distance between threads in metric connections. Place the gauge on the threads until the fit is snug. Match the measurement to the charts.

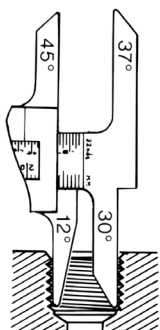

I.D.

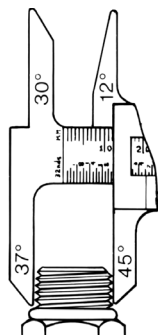

O.D.

Measure the thread diameter with an I.D./O.D. caliper as shown. Match the measurements to the charts.

How to measure sealing surface angles

Female connections are usually measured by inserting the gauge into the connection and placing it on the sealing surface. If the centerlines of the connection and gauge are parallel, the correct angle has been determined.

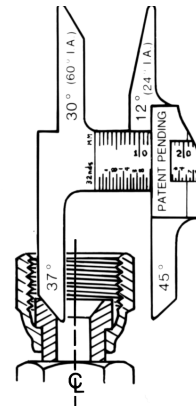

Male flare type connectors are usually measured by placing the gauge on the sealing surface. If the centerlines of the connection and gauge are parallel, the correct angle has been determined.

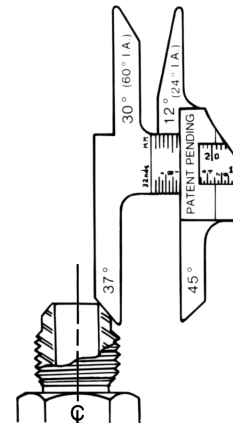

Fluid connectors

Thread size chart

A

Thread size chart

The following chart is intended as a quick reference guide for thread size by dash size.

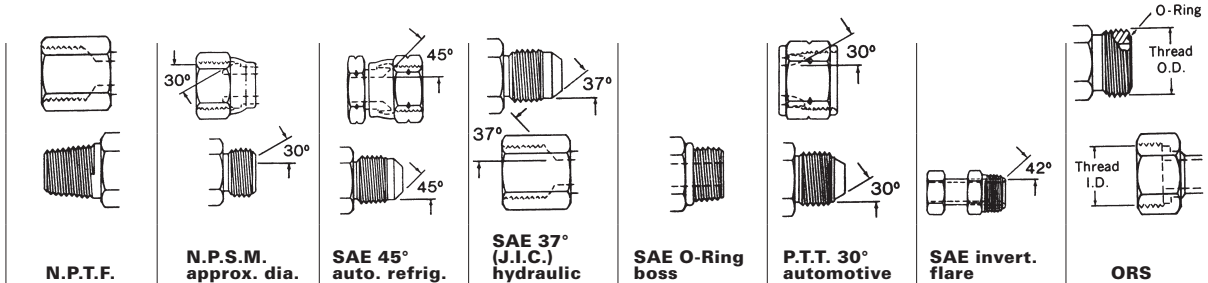

Dash size	N.P.T.F.	N.P.S.M. approx. dia.	SAE 45° auto. refriger.	SAE 37° (J.I.C.) hydraulic	SAE O-Ring boss	P.T.T. 30° automotive	SAE invert. flare	ORS
-02	1/8-27	1/8-27	5/16-24	5/16-24	5/16-24	-	5/16-24	-
-03	-	-	3/8-24	3/8-24	3/8-24	-	3/8-24	-
-04	1/4-18	1/4-18	7/16-20	7/16-20	7/16-20	-	7/16-24	9/16-18
-05	-	-	1/2-20	1/2-20	1/2-20	-	1/2-20	-
-06	3/8-18	3/8-18	5/8-18	9/16-18	9/16-18	-	5/8-18	11/16-16
-07	-	-	11/16-24	-	-	-	11/16-18	-
-08	1/2-14	1/2-14	3/4-16	3/4-16	3/4-16	-	3/4-18	13/16-16
-10	-	-	7/8-14	7/8-14	7/8-14	-	7/8-18	1-14
-12	3/4-14	3/4-14	1 1/16-14	1 1/16-12	1 1/16-12	-	1 1/16-16	1 3/16-12
-14	-	-	-	1 3/16-12	1 3/16-12	-	-	-
-16	1-11 1/2	1-11 1/2	-	1 5/16-12	1 5/16-12	1 5/16-14	-	1 7/16-12
-20	1 1/4-11 1/2	1 1/4-11 1/2	-	1 5/8-12	1 5/8-12	1 5/8-14	-	1 11/16-12
-24	1 1/2-11 1/2	1 1/2-11 1/2	-	1 7/8-12	1 7/8-12	1 7/8-14	-	2-12
-32	2-11 1/2	2-11 1/2	-	2 1/2-12	2 1/2-12	2 1/2-12	-	-
-40	2 1/2-8	2 1/2-8	-	3-12	3-12	-	-	-
-48	3-8	3-8	-	3 1/2-12	3 1/2-12	-	-	-

Through hole dimensions

All dimensions are nominal. In jump size bodies, the minimum through hole dimensions will correspond to the smallest dash size.

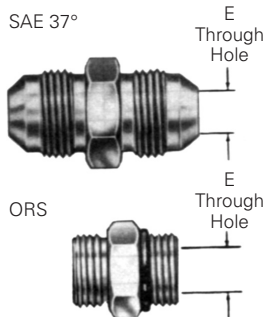

Dash size	E through hole			
	SAE 37°		ORS	
	mm	in	mm	in
-03	3,0	0.12	-	-
-04	4,3	0.17	4,3	0.17
-05	5,8	0.23	-	-
-06	7,6	0.30	6,6	0.26
-08	9,9	0.39	9,7	0.38
-10	12,2	0.48	12,2	0.48
-12	15,5	0.61	15,5	0.61
-16	21,3	0.84	20,6	0.81
-20	25,8	1.08	26,7	1.05
-24	33,3	1.31	33,3	1.31
-32	45,2	1.78	-	-

Proper tube installation

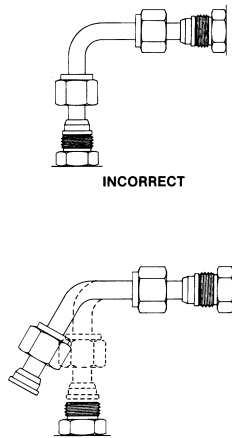

Figure 1

When compared to rigid pipe, hydraulic tubing offers the following advantages:

1. Size for size, tubing is lighter in weight, easier to handle and can be bent more easily than iron pipe.
2. Bent tubing reduces pressure drop and turbulence in the system because it eliminates sudden change in the direction of the fluid flow.
3. Hydraulic tubing reduces the number of connections required, thus reducing material and labor costs.
4. Fewer joints means lower costs and fewer points of potential leakage.
5. The use of tube fittings makes every joint a union which permits easier, faster maintenance and repair work.
6. The ORS-TF Tube Fitting eliminates the need for threading, brazing or welding.

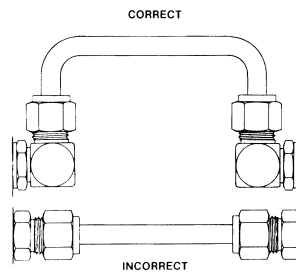

Figure 2

Tube bending

To reduce the number of fittings in a tube assembly, bend the tubing whenever possible.

Steel tubing can be bent in many sizes by using a hand bender designed for steel tubing. For production quantities, or for larger sizes, a power bending tool is generally used.

Contact Eaton for additional tube bending information.

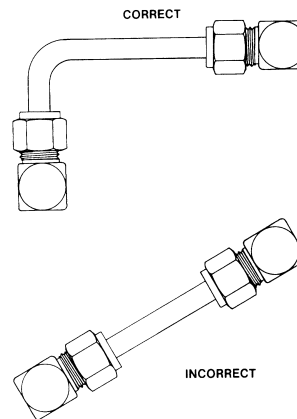

Figure 3

Tube routing and installation

Tubing manufacturers will advise the correct radii for various types and wall thicknesses of tubing. Kinks, flattened bends, wrinkles and tube breakage can be avoided by the use of proper tube bending equipment.

Avoid straight line connections whenever possible, especially in short runs.

Fluid conveying systems (see figures 2, 3 and 4) should be designed to follow the contour of the equipment. They are easier to install and present a neater appearance. Long runs should be supported by brackets or clamps. All heavy systems components should be bolted or clamped to eliminate tubing fatigue.

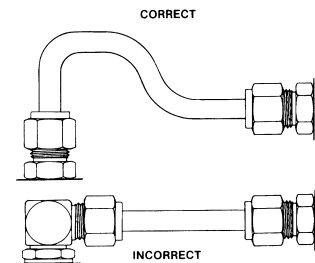

Figure 4

Inspect the tubing to see that it conforms to the required specifications before installation.

Tubes should align with the center line of the fittings, without distortion or tension. Tubing should not be sprung into position (see figure 1) to be assembled to the fitting. If this occurs the tubing has not been properly fabricated, and when installed and connected, places the tubing under stress.

Fluid connectors

Maximum operating pressure

A

Hydraulic tubing—Maximum operating pressures

SAEJ356, J524, J525, J526, J527

Tube O.D.	Dash size	Tubing wall thickness (in inches)											
		0.028		0.035		0.049		0.065		0.083		0.095	
		bar	psi	bar	psi	bar	psi	bar	psi	bar	psi	bar	psi
-	-												
0.19	-03	297,0	4250	375,0	5450	-	-	-	-	-	-	-	-
0.25	-04	213,0	3100	272,0	3950	396,0	5750	420,0	6000	-	-	-	-
0.31	-05	169,0	2450	213,0	3100	315,0	4500	420,0	6000	-	-	-	-
0.38	-06	140,0	2000	175,0	2550	251,0	3650	350,0	5000	420,0	6000	420,0	6000
0.50	-08	-	-	127,0	1850	186,0	2700	251,0	3650	335,0	4800	388,0	5550
0.62	-10	-	-	105,0	1500	145,0	2100	196,0	2850	258,0	3750	299,0	4350
0.75	-12	-	-	84,0	1200	122,0	1750	162,0	2350	210,0	3050	248,0	3550
1.00	-16	-	-	62,0	900	89,0	1300	122,0	1750	157,0	2250	182,0	2600
1.25	-20	-	-	-	-	70,0	1000	93,0	1350	122,0	1750	143,0	2050
1.50	-24	-	-	-	-	-	-	79,0	1150	100,0	1450	119,0	1700
2.00	-32	-	-	-	-	-	-	58,0	850	77,0	1100	87,0	1250

Tube O.D.	Dash size	Tubing wall thickness (in inches)											
		0.109		0.120		0.134		0.148		0.156		0.188	
		bar	psi	bar	psi	bar	psi	bar	psi	bar	psi	bar	psi
-	-												
0.19	-03	-	-	-	-	-	-	-	-	-	-	-	-
0.25	-04	-	-	-	-	-	-	-	-	-	-	-	-
0.31	-05	-	-	-	-	-	-	-	-	-	-	-	-
0.38	-06	-	-	-	-	-	-	-	-	-	-	-	-
0.50	-08	420,0	6000	420,0	6000	-	-	-	-	-	-	-	-
0.62	-10	353,0	5050	392,0	5600	-	-	-	-	-	-	-	-
0.75	-12	286,0	4150	322,0	4600	-	-	-	-	-	-	-	-
1.00	-16	210,0	3000	231,0	3350	262,0	3800	294,0	4200	-	-	-	-
1.25	-20	162,0	2350	182,0	2650	189,0	2700	203,0	2950	217,0	3100	259,0	3750
1.50	-24	134,0	1950	148,0	2150	171,0	2450	171,0	2450	182,0	2600	220,0	3150
2.00	-32	100,0	1450	112,0	1600	126,0	1800	140,0	2000	147,0	2100	178,0	2550

Maximum operating pressure ratings at specified wall thickness are based upon recommended tubing ratings per SAEJ1065 as well as limited laboratory test data. Operating pressures are

based upon a 4:1 safety factor relative to tube burst data. Eaton recommends a maximum operating pressure of the joint which is the lesser of the tubing rating or the mating connector rating.

Recommended wall thickness for tube fitting applications

Tube	Dash	Versil-Flare SAE 37° flare	Versil-Flare SAE 37° flareless	ORS-BR SAE O-Ring face seal	ORS-TF SAE O-ring face seal
0.19	-03	0.028 - 0.035	0.028 - 0.035	-	-
0.25	-04	0.028 - 0.065	0.028 - 0.065	0.028 - 0.065	0.028 - 0.065
0.31	-05	0.028 - 0.065	0.028 - 0.065	-	-
0.38	-06	0.028 - 0.065	0.028 - 0.095	0.035 - 0.083	0.028 - 0.065
0.50	-08	0.035 - 0.083	0.035 - 0.120	0.035 - 0.109	0.035 - 0.120
0.62	-10	0.035 - 0.095	0.035 - 0.120	0.035 - 0.120	0.035 - 0.095
0.75	-12	0.035 - 0.109	0.035 - 0.120	0.035 - 0.120	0.049 - 0.120
1.00	-16	0.035 - 0.120	0.035 - 0.134	0.049 - 0.148	0.049 - 0.134
1.25	-20	0.049 - 0.120	0.049 - 0.188	0.049 - 0.188	0.049 - 0.156
1.50	-24	0.065 - 0.120	0.065 - 0.188	0.065 - 0.188	0.065 - 0.188
2.00	-32	0.065 - 0.134	0.065 - 0.188	-	-

Recommended hydraulic tubing material specifications

Hydraulic tubing SAE specifications

Versil-Flare SAE 37° flare	Versil-Flare SAE 37° flareless	ORS-BR SAE O-ring face seal	ORS-TF SAE O-ring face seal
SAEJ524	SAEJ356	SAEJ356	SAEJ356
SAEJ525	SAEJ524	SAEJ524	SAEJ524
-	SAEJ525	SAEJ525	SAEJ525
-	SAEJ527	SAEJ526	SAEJ526

Hydraulic tubing material description

SAEJ356 electric resistance welded flash controlled low carbon steel, SAEJ524 seamless annealed low carbon steel, SAEJ525 electric resistance welded

cold worked annealed, SAEJ526 single wall welded low carbon steel (automotive), SAEJ527 brazed double wall low carbon steel (automotive). The maximum hardness of the above tubing should not exceed Rockwell B65.

Fluid connectors

Non-threaded connections, American connections

A

How to measure non-threaded connections

Four bolt flange

First measure the port hole diameter using the caliper. Next, measure the longest bolt hole spacing from center-to-center or measure the flange head diameter.

Staplok

Measure the male diameter with the O.D. portion of the caliper. Measure the female half by inserting the I.D. portion of the caliper into the through hole.

Dash numbers

Most fluid piping system sizes in the United States are measured by dash numbers. These are universally used abbreviations for the size of the component expressed as the numerator of the fraction

with the denominator always being 16. For example, a -04 port is 4/16 or 1/4-inch. Dash numbers are usually nominal (in name only) and are abbreviations that make ordering of components easier.

American connections

NPTF (National pipe tapered fuel)

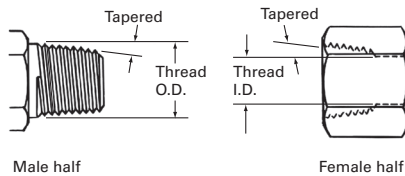

This connection is still widely used in fluid power systems, even though it is not recommended by the National Fluid Power Association (NFPA) for use in hydraulic

applications. The thread is tapered and the seal takes place by deformation of the threads.

NPSM (National pipe straight mechanical)

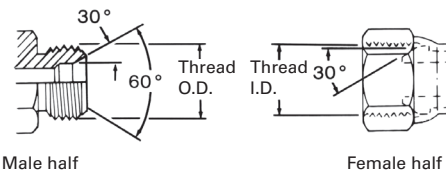

This connection is sometimes used in fluid power systems. The female half has a straight thread and an inverted 30° seat. The male half of the connection has a straight thread and a 30° internal chamfer. The seal takes place by compression of the 30°

seat on the chamfer. The threads hold the connection mechanically.

Note: A properly chamfered NPTF male will also seal with the NPSM female.

NPTF threads

Measure thread diameter and subtract 1/4-inch to find the nominal pipe size.

Inch size	Dash size.	Nominal thread size	Male thread O.D. inch		Female thread I.D. inch	
			Frac.	Dec.	Frac.	Dec.
1/8	02	1/8-27	13/32	0.41	3/8	0.38
1/4	04	1/4-18	17/32	0.54	1/2	0.49
3/8	06	3/8-18	11/16	0.68	5/8	0.63
1/2	08	1/2-14	27/32	0.84	25/32	0.77
3/4	12	3/4-14	1 1/16	1.05	1	0.98
1	16	1-11 1/2	1 5/16	1.32	1 1/4	1.24
1 1/4	20	1 1/4-11 1/2	1 21/32	1.66	1 19/32	0.58
1 1/2	24	1 1/2-11 1/2	1 29/32	1.90	1 13/16	1.82
2	32	2-11 1/2	2 3/8	2.38	2 5/16	2.30

NPSM threads

Inch size	Dash size.	Nominal thread size	Male thread O.D. inch		Female thread I.D. inch	
			Frac.	Dec.	Frac.	Dec.
1/8	02	1/8-27	13/32	0.41	3/8	0.38
1/4	04	1/4-18	17/32	0.54	1/2	0.49
3/8	06	3/8-18	11/16	0.68	5/8	0.63
1/2	08	1/2-14	27/32	0.84	25/32	0.77
3/4	12	3/4-14	1 1/16	1.05	1	0.98
1	16	1-11 1/2	1 5/16	1.32	1 1/4	1.24
1 1/4	20	1 1/4-11 1/2	1 21/32	1.66	1 19/32	0.58
1 1/2	24	1 1/2-11 1/2	1 29/32	1.90	1 13/16	1.82
2	32	2-11 1/2	2 3/8	2.38	2 5/16	2.30

American connections

SAE J1926 straight thread O-Ring boss (ORB)

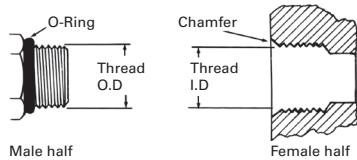

This port connection is recommended by the NFPA for optimum leakage control in medium and high pressure hydraulic systems. The male connector has a straight thread and an O-Ring. The female port has a straight

thread, a machined surface (minimum spotface) and a chamfer to accept the O-Ring. The seal takes place by compressing the O-Ring into the chamfer. The threads hold the connection mechanically.

Inch size	Dash size.	Nominal thread size	Male thread O.D. inch		Female thread I.D. inch	
			Fract.	Dec.	Fract.	Dec.
1/8	02	5/16-24	5/16	0.31	9/32	0.27
3/16	03	3/8-24	3/8	0.38	11/32	0.34
1/4	04	7/16-20	7/16	0.44	13/32	0.39
5/16	05	1/2-20	1/2	0.50	15/32	0.45
3/8	06	9/16-18	9/16	0.56	17/32	0.51
1/2	08	3/4-16	3/4	0.75	3/4	0.69
5/8	10	7/8-14	7/8	0.88	13/16	0.81
3/4	12	1 1/16-12	1 1/16	1.06	1	0.98
7/8	14	1 3/16-12	1 3/16	1.19	1 1/8	1.13
1	16	1 5/16-12	1 5/16	1.31	1 1/4	1.23
1 1/4	20	1 5/8-12	1 5/8	1.63	1 9/16	1.54
1 1/2	24	1 7/8-12	1 7/8	1.88	1 13/16	1.79
2	32	2 1/2-12	2 1/2	2.50	2 7/16	2.42

SAE J514 37° hydraulic

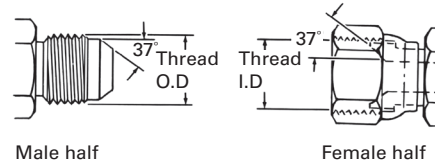

This connection is very common in fluid power systems. Both the male and female halves of the connections have 37° seats. The seal takes place by establishing a line contact between the male flare and the female cone seat.

The threads hold the connection mechanically.

Caution: In the -02, -03, -04, -05, -08 and -10 sizes, the threads of the SAE 45° flare and the SAE 37° flare are the same. However, the sealing surface angles are not the same.

Inch size	Dash size.	Nominal thread size	Male thread O.D. inch		Female thread I.D. inch	
			Fract.	Dec.	Fract.	Dec.
1/8	02	5/16-24	5/16	0.31	9/32	0.27
3/16	03	3/8-24	3/8	0.38	11/32	0.34
1/4	04	7/16-20	7/16	0.44	13/32	0.39
5/16	05	1/2-20	1/2	0.50	15/32	0.45
3/8	06	9/16-18	9/16	0.56	17/32	0.51
1/2	08	3/4-16	3/4	0.75	3/4	0.69
5/8	10	7/8-14	7/8	0.88	13/16	0.81
3/4	12	1 1/16-12	1 1/16	1.06	1	0.98
7/8	14	1 3/16-12	1 3/16	1.19	1 1/8	1.13
1	16	1 5/16-12	1 5/16	1.31	1 1/4	1.23
1 1/4	20	1 5/8-12	1 5/8	1.63	1 9/16	1.54
1 1/2	24	1 7/8-12	1 7/8	1.88	1 13/16	1.79
2	32	2 1/2-12	2 1/2	2.50	2 7/16	2.42

ORS SAE J1453 O-Ring face seal

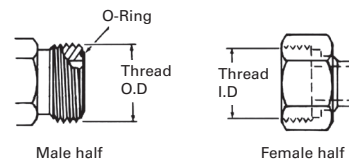

This connection offers the very best leakage control available today. The male connector has a straight thread and an O-Ring in the face. The female has a straight thread and a machined flat face.

The seal takes place by compressing the O-Ring onto the flat face of the female, similar to the split flange type fitting. The threads hold the connection mechanically.

Inch size	Dash size.	Nominal thread size	Male thread O.D. inch		Female thread I.D. inch	
			Fraction	Decimal	Fraction	Decimal
1/4	04	9/16-18	9/16	0.56	17/32	0.51
3/8	06	11/16-16	11/16	0.69	5/8	0.63
1/2	08	13/16-16	13/16	0.82	3/4	0.75
5/8	10	1-14	1	1.00	15/16	0.93
3/4	12	1 3/16-12	1 3/16	1.19	1 1/8	1.11
1	16	1 7/16-12	1 7/16	1.44	1 3/8	1.36
1 1/4	20	1 11/16-12	1 11/16	1.69	1 5/8	1.61
1 1/2	24	2-12	2	2.00	1 15/16	1.92

Fluid connectors

American connections

A

American connections

SAE J512 inverted

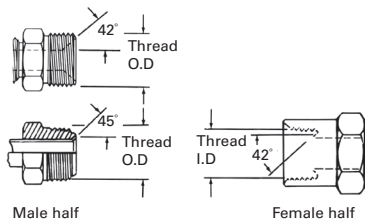

This connection is frequently used in automotive systems. The male connector can either be a 45° flare in the tube fitting form or a 42° seat in the machined adapter form.

The female has a straight thread with a 42° inverted flare. The seal takes place on the flared surfaces. The threads hold the connection mechanically.

Inch size	Dash size	Nominal thread size	Male thread O.D. inch		Female thread I.D. inch	
			Fract.	Dec.	Fract.	Dec.
1/8	02	5/16-24	5/16	0.32	9/32	0.28
3/16	03	3/8-24	3/8	0.38	11/32	0.34
1/4	04	7/16-24	7/16	0.44	13/32	0.40
5/16	05	1/2-20	1/2	0.50	15/32	0.45
3/8	06	5/8-18	5/8	0.63	9/16	0.57
7/16	07	11/16-18	11/16	0.69	5/8	0.63
1/2	08	3/4-18	3/4	0.75	23/32	0.70
5/8	10	7/8-18	7/8	0.88	13/16	0.82
3/4	12	1 1/16-16	1 1/16	1.06	1	1.00

SAE J512 45°

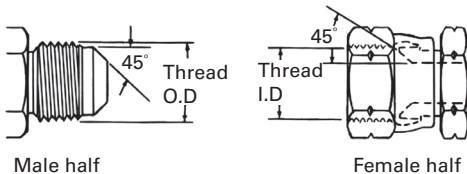

This connection is commonly used in refrigeration, automotive and truck piping systems. The connector is frequently made of brass. Both the male and female connectors have 45° seats. The seal takes place between the male flare the female cone seat.

The threads hold the connection mechanically.

Caution: In the -02, -03, -04, -05, -08 and -10 sizes, the threads of the SAE 45° flare and the SAE 37° flare are the same. However, the sealing surface angles are not the same.

Inch size	Dash size	Nominal thread size	Male thread O.D. inch		Female thread I.D. inch	
			Fract.	Dec.	Fract.	Dec.
1/8	02	5/16-24	5/16	0.31	9/32	0.27
3/16	03	3/8-24	3/8	0.38	11/32	0.34
1/4	04	7/16-20	7/16	0.44	13/32	0.39
5/16	05	1/2-20	1/2	0.50	15/32	0.45
3/8	06	5/8-18	5/8	0.63	9/16	0.57
1/2	08	3/4-16	3/4	0.75	11/16	0.69
5/8	10	7/8-14	7/8	0.88	13/16	0.81
3/4	12	1 1/16-14	1 1/16	1.06	1	0.99
7/8	14	1 1/4-12	1 1/4	1.25	1 5/32	1.16
1	16	1 3/8-12	1 3/8	1.38	1 9/32	1.29

Staplok (SAE J1467)

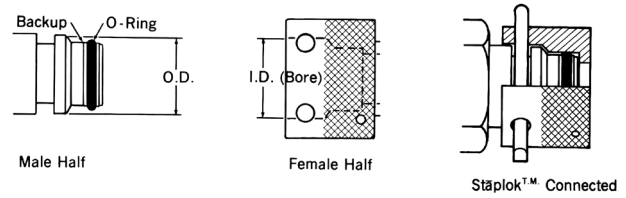

This is a radial O-Ring seal connection developed in Germany and commonly used for hydraulic application in underground mines. The male contains an exterior O-Ring and backup ring, plus a groove to accept the "staple". The female has a smooth bore

with two holes for the staple. A "U" shaped retaining clip or staple is inserted through the two holes, passing through the groove in the male to lock the connection together. The seal takes place by contact between the O-Ring in the male and the smooth bore of the female.

Inch size	Dash size	Nominal thread size	Male thread O.D. inch		Female thread I.D. inch	
			Fraction	Decimal	Fraction	Decimal
1/4	04	-	9/32	0.586	1 9/32	0.597
3/8	06	-	25/32	0.783	51/64	0.794
1/2	08	-	15/16	0.940	61/64	0.951
3/4	12	-	1 9/64	1.137	1 9/64	1.148
1	16	-	1 17/32	1.529	1 35/64	1.540
1 1/4	20	-	1 13/16	1.806	1 13/16	1.817
1 1/2	24	-	2 5/32	2.163	2 11/64	2.174
2	32	-	2 33/64	2.517	2 17/32	2.528

American connections

How to measure

Four Bolt Flange—First measure the port hole diameter using the caliper.

Next, measure the longest bolt hole spacing from center-to-center (Dimension "A") or measure the flanged head diameter.

SAE J518 4-Bolt Flange*

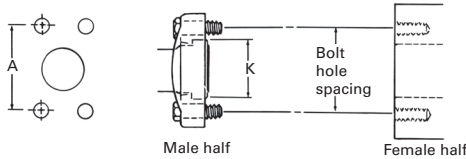

This connection is commonly used in fluid power systems. There are two pressure ratings. Code 61 is referred to as the "standard" series and Code 62 is the "6000 psi" series. The design concept for both series is the same, but the bolt hole spacing and flanged head diameters are larger for the higher pressure, Code 62 connection. The female (port) is an unthreaded hole with four bolt holes in a rectangular pattern around the port. The male consists of a flanged head, grooved

for an O-Ring, and either a captive flange or split flange halves with bolt holes to match the port. The seal takes place on the O-Ring, which is compressed between the flanged head and the flat surface surrounding the port. The threaded bolts hold the connection together.

Note: * SAE J518, JIS B 8363, ISO/ DIS 6162 and DIN 20066 are interchangeable, except for bolt sizes.

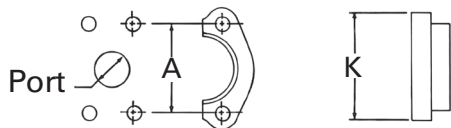

Inch Size (dash size)	Port hole I.D. inch (fract. deci.)	Bolt dimension inch		Bolt hole spacing "A" inch (dec)		Flanged head dia. "K" inch (dec)	
		Cd. 61	Cd. 62	Cd. 61	Cd. 62	Cd. 61	Cd. 62
1/2 (08)	1/2 (0.50)	5/16-18x1 1/4	5/16-18x1 1/4	1 1/2 (1.50)	1 19/32 (1.59)	1 3/16 (1.19)	1 1/4 (1.25)
3/4 (12)	3/4 (0.75)	3/8-16x1 1/4	3/8-16x1 1/2	1 7/8 (1.88)	2.00 (2.00)	1 1/2 (1.50)	1 5/8 (1.63)
1 (16)	1.00 (1.00)	3/8-16x1 1/4	7/16-14x1 3/4	2 1/16 (2.06)	2 1/4 (2.25)	1 3/4 (1.75)	1 7/8 (1.88)
1 1/4 (20)	1 1/4 (1.25)	7/16-14x1 1/2	1/2-13x1 3/4	2 5/16 (2.31)	2 5/8 (2.63)	2.00 (2.00)	2 1/8 (2.13)
1 1/2 (24)	1 1/2 (1.50)	1/2-13x1 1/2	5/8-11x2 1/4	2 3/4 (2.75)	3 1/8 (3.12)	2 3/8 (2.38)	2 1/2 (2.50)
2 (32)	2.00 (2.00)	1/2-13x1 1/2	3/4-10x2 3/4	3 1/16 (3.06)	3 13/16 (3.81)	2 13/16 (2.81)	3 1/8 (3.12)

ISO connections

ISO/DIS 6162 4-bolt flange*

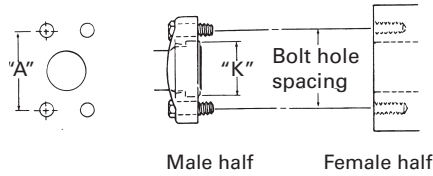

This connection is commonly used in fluid power systems. There are two pressure ratings. PN 35/350 bar (Code 61) is the "standard" series and PN 415 bar (Code 62) is the high pressure series. The design concept for both series is the same, but the bolt hole spacing and flanged head diameters are larger for the higher pressure, PN 415 bar connection. Both metric and inches bolts are used. The port will have an "M" stamped on it if metric bolts are required.

The female (port) is an unthreaded hole with four bolt holes in a rectangular pattern around the port. The seal consists of a flanged head, grooved for an O-Ring, and either a captive flange or split flange halves with bolt holes to match the port. The seal takes place on the O-Ring, which is compressed between the flanged head and the flat surface surrounding the port. The threaded bolts hold the connection together.

* ISO/DIS 6162, DIN 20066, JIS B 8363 and SAE J518 are interchangeable, except for bolt sizes.

Size	Port hole	Bolt dimensions spacing		Bolt hole "A"	
		ISO 6162-1 Bar (Cd.61)	ISO 6162-2 Bar (Cd.62)	ISO 6162-1 Bar (Cd.61)	ISO 6162-2 Bar (Cd.62)
mm in (dash)	mm (in)	mm (in)	mm (in)	mm (in)	mm (in)
13(1/2) (08)	12.7 (.50)	M8 x 1.25 x 30 (5/16-18 x 1 1/4)	M8 x 1.25 x 30 (5/16-18 x 1 1/4)	38.1 (1.50)	40.5 (1.57)
19(3/4) (12)	19.1 (.75)	M10 x 1.5 x 35 (3/8-16 x 1 1/4)	M10 x 1.5 x 40 (3/8-16 x 1 1/2)	47.6 (1.88)	50.8 (2.00)
25(1) (16)	25.4 (1.00)	M10 x 1.5 x 35 (3/8-16 x 1 1/4)	M12 x 1.75 x 45 (7/16-14 x 1 3/4)	52.4 (2.06)	57.2 (2.25)
32(1 1/4) (20)	31.8 (1.25)	M10 x 1.5 x 40 (7/16-14 x 1 1/2)	M14 x 2 x 50 (1/2-13 x 1 3/4)	58.7 (2.31)	66.7 (2.63)
38(1 1/2) (24)	38.1 (1.50)	M12 x 1.75 x 40 (1/2-13 x 1 1/2)	M16 x 2 x 55 (5/8-11 x 2 1/4)	69.9 (2.75)	79.4 (3.13)
51(2) (32)	50.8 (2.00)	M12 x 1.75 x 40 (1/2-13 x 1 1/2)	M20 x 2.5 x 70 (3/4-10 x 2 3/4)	77.8 (3.06)	96.8 (3.81)

Inch size	Flanged head dia. "K"			
	ISO 6162-1 Bar (Cd.61)		ISO 6162-2 Bar (Cd.62)	
	mm	in	mm	in
1/2	30.18	1.19	31.75	1.25
3/4	38.10	1.50	41.28	1.63
1	44.45	1.75	47.63	1.88
1 1/4	50.80	2.00	53.98	2.13
1 1/2	60.33	2.38	63.50	2.50
2	71.42	2.81	79.38	3.13

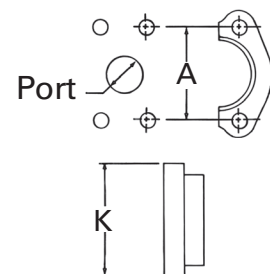

Fluid connectors

German connections

A

German connections

DIN 7631 series

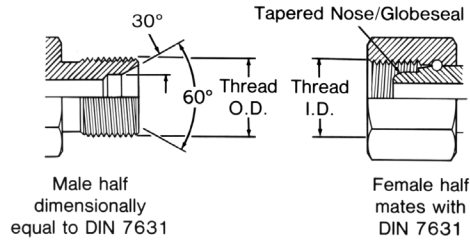

This connection is frequently used in hydraulic systems. The male has a straight metric thread and a 60° (included angle) recessed cone. The female has a straight thread and a tapered Nose/Globeseal

seat. The seal takes place by contact between the cone of the male and the nose of the tapered Nose/Globeseal flareless swivel.

The threads hold the connection mechanically.

Use with pipe/tube O.D.		Metric thread size	Male thread O.D.		Female thread I.D.	
mm	in		mm	in	mm	in
6	0.24	M12 x 1.5	12	0.47	10,5	0.41
8	0.32	M14 x 1.5	14	0.55	12,5	0.49
10	0.39	M16 x 1.5	16	0.63	14,5	0.57
12	0.47	M18 x 1.5	18	0.71	16,5	0.65
15	0.59	M22 x 1.5	22	0.87	20,5	0.81
18	0.71	M26 x 1.5	26	1.02	24,5	0.96
22	0.87	M30 x 1.5	30	1.18	28,5	1.12
28	1.10	M38 x 1.5	38	1.50	36,5	1.44
35	1.38	M45 x 1.5	45	1.77	43,5	1.71
42	1.65	M52 x 1.5	52	2.04	50,5	1.99

DIN 3902 series

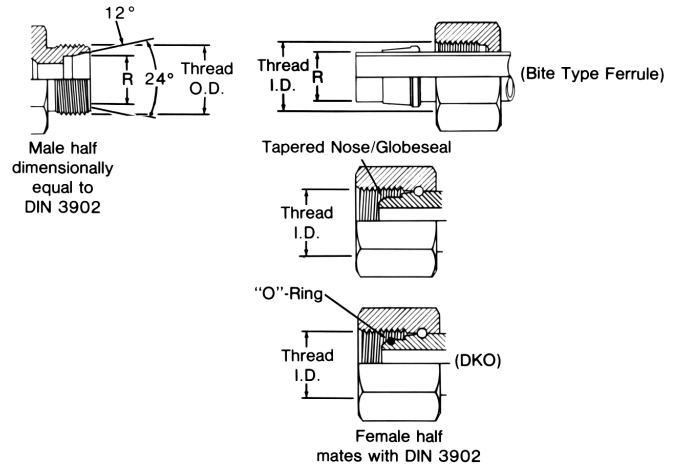

This connection style consists of a common male and three different female halves. The male has a straight metric thread, a 24° included angle and a recessed counterbore that matches the tube O.D. used with it. The female may

be a tube, nut and ferrule, a tapered nose/Globeseal flareless swivel or a tapered Nose/Globeseal flareless swivel with an O-Ring in the Nose (DKO type).

Tube O.D. "R" Dim. I.Rh.*		Tube O.D. "R" Dim. s.Rh.†		Metric thread Size	Male thread O.D.		Female thread I.D.	
mm	in.	mm	in		mm	in	mm	in
6	0.24	-	-	M12 x 1.5	12	0.47	10.5	0.41
8	0.32	6	0.24	M14 x 1.5	14	0.55	12.5	0.49
10	0.39	8	0.32	M16 x 1.5	16	0.63	14.5	0.57
12	0.47	10	0.39	M18 x 1.5	18	0.71	16.5	0.65
-	-	12	0.47	M20 x 1.5	20	0.78	18.5	0.73
15	0.59	14	0.55	M22 x 1.5	22	0.87	20.5	0.81
-	-	16	0.63	M24 x 1.5	24	0.94	22.5	0.89
18	0.71	-	-	M26 x 1.5	26	1.02	24.5	0.96
22	0.87	20	0.78	M30 x 2.0	30	1.18	28	1.11
28	1.10	25	0.98	M36 x 2.0	36	1.41	34	1.34
-	-	30	1.18	M42 x 2.0	42	1.65	40	1.57
35	1.38	-	-	M45 x 2.0	45	1.77	43	1.70
42	1.65	38	1.50	M52 x 2.0	52	2.04	50	1.97

*I.Rh. is a light duty system.
†s.Rh. is a heavy duty system.

German connections

DIN 20066 4-bolt flange*

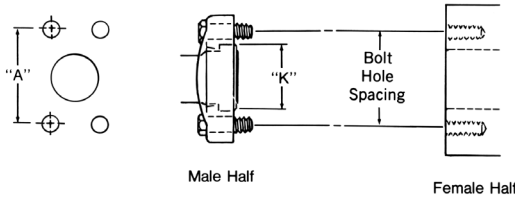

This connection is commonly used in fluid power systems. There are two pressure ratings. Form R (Code 61) is referred to as the “standard duty” series and Form S (Code 62) is the “heavy duty” series. The design concept for both series is the same, but the bolt hole spacing and flanged head diameters are larger for the higher pressure, Form S connection. Both metric and inch bolts are used. The female (port) is an unthreaded hole with four bolt holes in a rectangular pattern around the port. The male

consists of a flanged head, grooved for an O-Ring, and either a captive flange or split flange halves with bolt holes to match the port. The seal takes place on the O-Ring, which is compressed between the flanged head and the flat surface surrounding the port. The threaded bolts hold the connection together.

Note: *DIN 20066, IS/DIS 6166, JIS B 8363 and SAE J518 are interchangeable, except for bolt sizes.

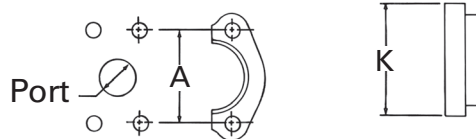

Inch size	Flanged head dia. “K”			
	Form R (Cd. 61)		Form S (Cd. 62)	
	mm	in	mm	in
1/2	30.18	1.19	31.75	1.25
3/4	38.10	1.50	41.28	1.63
1	44.45	1.75	47.63	1.88
1 1/4	50.80	2.00	53.98	2.13
1 1/2	60.33	2.38	63.50	2.50
2	71.42	2.81	79.38	3.13

Size mm (inch) (dash)	Port hole	Bolt dimensions		Bolt hole spacing	
		Form R (Cd. 61)	Form S (Cd. 62)	Form R (Cd. 61)	Form S (Cd. 62)
		mm (in)	-	mm (in)	mm (in)
12 (1/2) (08)	12,7 (0.50)	M8 x 1.25 x 30 5/16–18 x 1 1/4	M8 x 1.25 x 30 5/16–18 x 1 1/4	38,10 (1.50)	40,49 (1.57)
20 (3/4) (12)	19,1 (0.75)	M10 x 1.5 x 30 3/8–16 x 1 1/4	M10 x 1.5 x 40 3/8–16 x 1 1/2	47,63 (1.88)	50,80 (2.00)
25 (1) (16)	25,4 (1.00)	M10 x 1.5 x 35 3/8–16 x 1 1/4	M12 x 1.75 x 45 7/16–14 x 1 3/4	52,37 (2.06)	57,15 (2.25)
32 (1-1/4) (20)	31,7 (1.25)	M10 x 1.75 x 40 7/16–14 x 1 1/2	M14 x 2 x 45 1/2–13 x 1 3/4	58,72 (2.31)	66,68 (2.63)
40 (1-1/2) (24)	38,0 (1.50)	M12 x 1.75 x 40 1/2–13 x 1 1/2	M16 x 2 x 55 5/8–11 x 2 1/4	69,85 (2.75)	79,38 (3.13)
50 (2) (32)	50,8 (2.00)	M12 x 1.75 x 40 1/2–13 x 1 1/2	M20 x 2.5 x 70 3/4–10 x 2 3/4	77,77 (3.06)	96,82 (3.81)

Fluid connectors

German connections

A

German connections

DIN 3852 Male connectors and female ports

DIN 3852 metric threads

Metric thread	Male thread O.D. "A"		Female thread I.D. "B"	
	mm	(in)	mm	(in)
M12 x 1.5	12	0.47	10,5	0.41
M14 x 1.5	14	0.55	12,5	0.49
M16 x 1.5	16	0.63	14,5	0.57
M18 x 1.5	18	0.71	16,5	0.65
M20 x 1.5	20	0.78	18,5	0.73
M22 x 1.5	22	0.87	20,5	0.81
M24 x 1.5	24	0.94	22,5	0.89
M26 x 1.5	26	1.02	24,5	0.96
M27 x 2	27	1.06	25	0.98
M30 x 1.5	30	1.18	28,5	1.12
M30 x 2	30	1.18	28	1.10
M33 x 2	33	1.30	31	1.22
M36 x 1.5	36	1.41	34,5	1.36
M36 x 2	36	1.41	34	1.33
M38 x 1.5	38	1.49	36,5	1.43
M38 x 2	38	1.49	36	1.41
M42 x 1.5	42	1.65	40,5	1.60
M42 x 2	42	1.65	40	1.57
M45 x 1.5	45	1.77	43,5	1.71
M45 x 2	45	1.77	43	1.69
M48 x 1.5	48	1.89	46,5	1.83
M48 x 2	48	1.89	46	1.81
M52 x 1.5	52	2.04	50,5	1.89
M52 x 2	52	2.04	50	1.97

For DIN 3852 Whitworth pipe thread dimensions, see BSPT/BSPP dimensions. They are the same.

FORM A (SEALING WITH A WASHER) MATES WITH FORM X OR Y

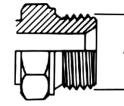

FORM B (SEALING WITH A COMPACT EDGE) MATES WITH FORM X OR Y

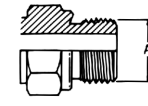

FORM E (SEALING BY AGREEMENT) MATES WITH FORM X OR Y

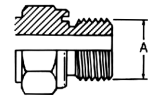
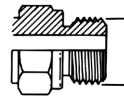

FORM C (SEALING WITH A CONE THREAD) MATES WITH FORM X, Y, OR Z

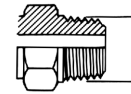

FORM Z MATES WITH FORM C ONLY

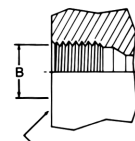

SURFACE IS NOT MACHINED SMOOTH.

FORM X AND Y MATES WITH FORM A, B, C, AND E

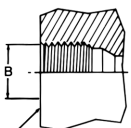

SURFACE IS MACHINED SMOOTH, MAY BE A SPOTFACE.

How the seal works

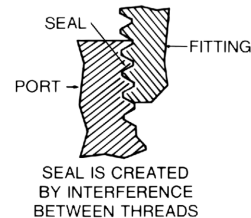
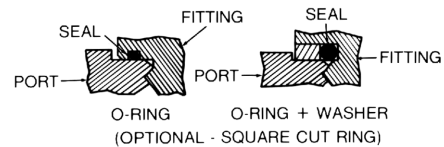
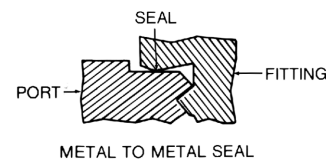
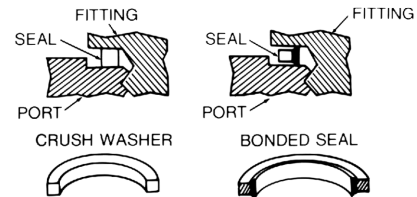

French connections

Millimetrique and GAZ series

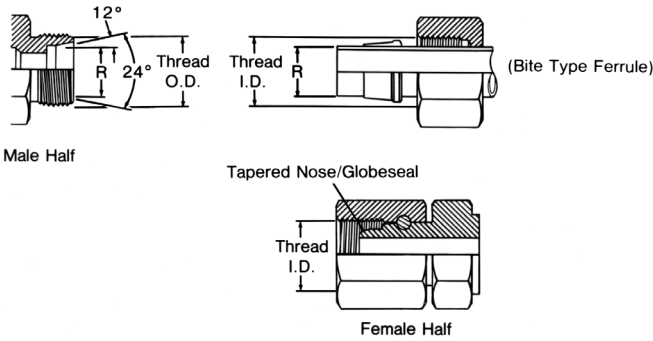

This connection consists of a common male and two different females. The millimetric series is used with whole

number metric O.D. tubing and the GAZ Series is used with fractional number metric O.D. pipe size tubing.

Millimetric and GAZ threads

Tubing O.D. "R" dim.		"Gaz" pipe O.D. "R" dim.		Metric thread	Male Thread O.D. "A"		Female Thread I.D. "B"	
mm	in	mm	in		mm	(in)	mm	(in)
6	0.24	-	-	M12 x 1.5	12	0.47	11	0.43
8	0.32	-	-	M14 x 1.5	14	0.55	12.5	0.49
10	0.39	-	-	M16 x 1.5	16	0.63	14.5	0.57
12	0.47	-	-	M18 x 1.5	18	0.71	16.5	0.65
14	0.55	13.25	0.52	M20 x 1.5	20	0.78	18.5	0.73
15	0.59	-	-	M22 x 1.5	22	0.87	20.5	0.81
16	0.63	16.75	0.66	M24 x 1.5	24	0.94	22.5	0.89
18	0.71	-	-	M27 x 1.5	27	1.06	25.5	1.00
22	0.87	21.25	0.83	M30 x 1.5	30	1.18	28.5	1.12
25	0.98	-	-	M33 x 1.5	33	1.30	31.5	1.24
28	1.10	26.75	1.05	M36 x 1.5	36	1.41	34.5	1.36
30	1.18	-	-	M39 x 1.5	39	1.54	37.5	1.48
32	1.25	-	-	M42 x 1.5	42	1.65	40.5	1.60
35	1.38	33.50	1.32	M45 x 1.5	45	1.77	43.5	1.71
38	1.50	-	-	M48 x 1.5	48	1.89	46.5	1.83
40	1.57	42.25	1.66	M52 x 1.5	52	2.04	50.5	1.99
45	1.77	-	-	M54 x 2.0	54	2.12	52	2.05
-	-	48.25	1.90	M58 x 2.0	58	2.28	55	2.16

British connections

British standard pipe(BSP)

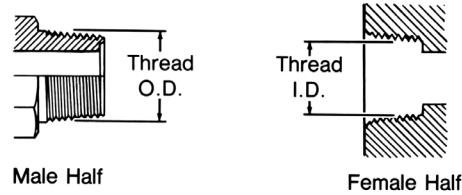

This BSPT (tapered) connection is similar to the NPT, except that the thread pitches are different in most sizes, and the thread

form and O.D.s are close but not the same. Sealing is accomplished by thread distortion. A thread sealant is recommended.

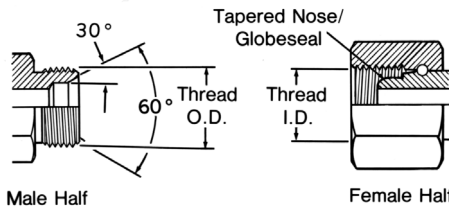

The BSP (parallel) male is similar to the NPSM male except the thread pitches are different in most sizes.

The female swivel BSPP has a tapered nose/Globeseal flareless swivel which seals on the cone seat of the male.

BSPT/BSPP threads

Inch size	Dash size	Nominal thread size	Male thread O.D. inch		Female thread I.D. inch	
			fraction	decimal	fraction	decimal
1/8	02	1/8-28	3/8	0.38	11/32	0.35
1/4	04	1/4-19	33/64	0.52	15/32	0.47
3/8	06	3/8-19	21/32	0.65	19/32	0.60
1/2	08	1/2-14	13/16	0.82	3/4	0.75
5/8	10	5/8-14	7/8	0.88	13/16	0.80
3/4	12	3/4-14	1 1/32	1.04	31/32	0.97
1	16	1-11	1 5/16	1.30	1 7/32	1.22
1 1/4	20	1 1/4-11	1 21/32	1.65	1 9/16	1.56
1 1/2	24	1 1/2-11	1 7/8	1.88	1 25/32	1.79
2	32	2-11	2 11/32	2.35	2 1/4	2.26

*Frequently, the thread size is expressed as a fractional dimension preceded by the letter "G" or the letter "R". The "G" represents a parallel thread and the "R" indicates a tapered thread. For example, BSPP 3/8-19 may be expressed as G 3/8, and BSPT 3/8-19 may be expressed as R3/8.

Fluid connectors

Japanese connections

A

Japanese connections

JIS 30° male inverted seat, parallel pipe threads

(Threads per JIS B 0202)

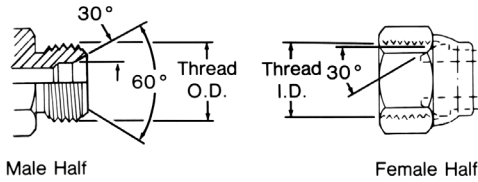

The JIS parallel is similar to the BSPP connection. The JIS parallel thread and

the BSPP connection are interchangeable.

Inch size	Dash size	Nominal thread size (similar to bspp)	Male thread O.D.		Female thread O.D.	
			fract.	dec.	fract.	dec.
1/4	6 (04)	1/4-19	33/64	13.2	15/32	11.9
3/8	9 (06)	3/8-19	21/32	16.7	19/32	15.3
1/2	12 (08)	1/2-14	13/16	21.0	3/4	19.2
3/4	19 (12)	3/4-14	1 1/32	26.4	31/32	24.6
1	25 (16)	1-11	1 5/16	33.3	1 7/32	30.9
1 1/4	32 (20)	1 1/4-11	1 21/32	41.9	1 9/16	39.6
1 1/2	38 (24)	1 1/2-11	1 7/8	47.8	1 25/32	45.5
2	50 (32)	2-11	2 11/32	59.7	2 1/4	57.4

JIS 30° male inverted seat, parallel pipe threads

(Threads per JIS B 0207)

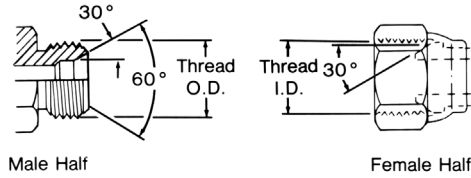

The JIS parallel (metric) is the same as the JIS parallel

(PF), except for the thread difference.

Inch size	Dash size equivalent	Thread size	Male thread O.D.		Female thread O.D.	
			fract.	dec.	fract.	dec.
6	04	M14 x 1.5	14	0.55	12.5	0.49
9	06	M18 x 1.5	18	0.71	16.5	0.65
12	08	M22 x 1.5	22	0.87	20.5	0.81
19	12	M30 x 1.5	30	1.18	28.5	1.12
25	16	M33 x 1.5	33	1.30	31.5	1.24
32	20	M42 x 1.5	42	1.65	40.5	1.60

JIS Tapered pipe (PT)

(Threads per JIS B 0203)

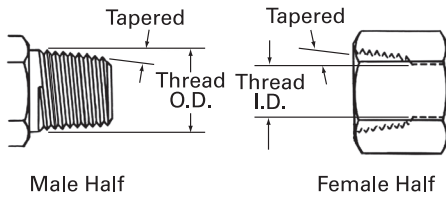

The JIS tapered thread is similar to the BSPT connection in design, appearance and dimensions.

The JIS tapered thread and the BSPT connection are interchangeable.

Inch size	Dash size	Nominal thread size (similar to bspp)	Male thread O.D. inch		Female thread I.D. inch	
			fract.	dec.	fract.	dec.
1/4	6 (04)	1/4-19	33/64	13.2	15/32	11.9
3/8	9 (06)	3/8-19	21/32	16.7	19/32	15.3
1/2	12 (08)	1/2-14	13/16	21.0	3/4	19.2
3/4	19 (12)	3/4-14	1 1/32	26.4	31/32	24.6
1	25 (16)	1-11	1 5/16	33.3	1 7/32	30.9
1 1/4	32 (20)	1 1/4-11	1 21/32	41.9	1 9/16	39.6
1 1/2	38 (24)	1 1/2-11	1 7/8	47.8	1 25/32	45.5
2	50 (32)	2-11	2 11/32	59.7	2 1/4	57.4

JIS 30° female (cone) seat, parallel pipe threads (PT)

(Threads per JIS B 0202)

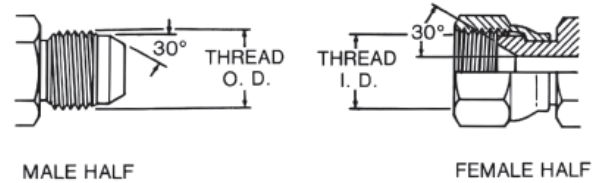

The Japanese JIS 30° flare is similar to the American SAE 37° flare connection in application as well as sealing

principles. However, the flare angle and dimensions are different. The threads are similar to BSPP.

Inch size	Dash size	Nominal thread size (similar to bspp)	Male thread O.D. inch		Female thread O.D. inch	
			fract.	dec.	fract.	dec.
1/4	6 (04)	1/4-19	33/64	13.2	15/32	11.9
3/8	9 (06)	3/8-19	21/32	16.7	19/32	15.3
1/2	12 (08)	1/2-14	13/16	21.0	3/4	19.2
3/4	19 (12)	3/4-14	1 1/32	26.4	31/32	24.6
1	25 (16)	1-11	1 5/16	33.3	1 7/32	30.9
1 1/4	32 (20)	1 1/4-11	1 21/32	41.9	1 9/16	39.6
1 1/2	38 (24)	1 1/2-11	1 7/8	47.8	1 25/32	45.5
2	50 (32)	2-11	2 11/32	59.7	2 1/4	57.4

Japanese connections

JIS B 8363 4-bolt flange*

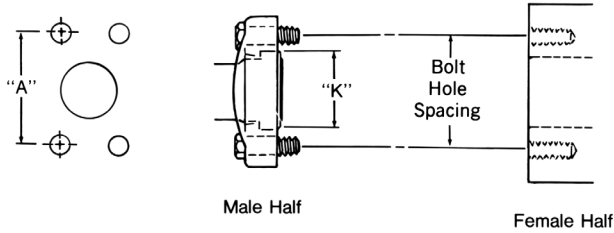

This connection is commonly used in fluid power systems. There are two pressure ratings. Type I (Code 61) is referred to as the "standard" series and Type II (Code 62) is the "6000 psi" series. The design concept for both series is the same, but the bolt hole spacing and flanged head diameters are larger for the higher pressure, Type II connection. Both metric and inch bolts are used. The female (port) is an unthreaded hole with four bolt holes in a rectangular pattern around the port. The male

consists of a flanged head, grooved for an O-Ring, and either a captive flange or split flange halves with bolt holes to match the port. The seal takes place on the O-Ring, which is compressed between the flanged head and the flat surface surrounding the port. The threaded bolts hold the connection together.

Note: *JIS B 8363, ISO/DIS 6162, DIN 20066, and SAE J518 are interchangeable, except for bolt sizes.

Size mm inch (dash)	Port hole mm (inch)	Bolt dimensions mm & inch		Bolt hole spacing "A" mm (inch)	
		Type I (Cd.61)	Type II (Cd. 62)	Type I (Cd. 61)	Type II (Cd. 62)
mm in (dash)	mm (in)	mm (in)	mm (in)	mm(in)	mm (in)
12(1/2) (08)	12,7 (0.50)	M8 x 1.25 x 30 (5/16-18 x 1 1/4)	M8 x 1.25 x 30 (5/16-18 x 1 1/4)	38.1 (1.50)	40.49 (1.57)
19(3/4) (12)	19,1 (0.75)	M10 x 1.5 x 30 (3/8-16 x 1 1/4)	M10 x 1.5 x 40 (3/8-16 x 1 1/2)	47.63 (1.88)	50.80 (2.00)
25(1) (16)	25,4 (1.00)	M10 x 1.5 x 30 (3/8-16 x 1 1/4)	M12 x 1.75 x 45 (7/16-14 x 1 3/4)	52.37 (2.06)	57.15 (2.25)
32 (1 1/4) (20)	31,7 (1.25)	M10 x 1.5 x 40 (7/16-14 x 1 1/2)	M14 x 2 x 45 (1/2-13 x 1 3/4)	58.72 (2.31)	66.68 (2.63)
38 (1 1/2) (24)	38,0 (1.50)	M12 x 1.75 x 40 (1/2-13 x 1 1/2)	M16 x 2 x 55 (5/8-11 x 2 1/4)	69.85 (2.75)	79.38 (3.13)
50(2) (32)	50,8 (2.00)	M12 x 1.75 x 40 (1/2-13 x 1 1/2)	M20 x 2.5 x 70 (3/4-10 x 2 3/4)	77.77 (3.06)	96.82 (3.81)

Inch size	Flanged head dia. "K"			
	Type I bar (Cd.61)		Type II bar (Cd. 62)	
	mm	in	mm	in
1/2	30,18	1.19	31,75	1.25
3/4	38,10	1.50	41,28	1.63
1	44,45	1.75	47,63	1.88
1 1/4	50,80	2.00	53,98	2.13
1 1/2	60,33	2.38	63,50	2.50
2	71,42	2.81	79,38	3.13

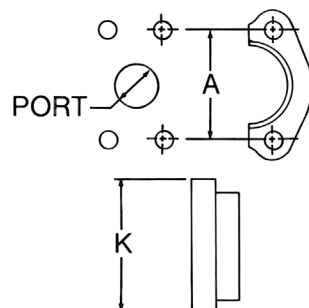

JIS 210 Kgf/cm2 4-bolt square flange

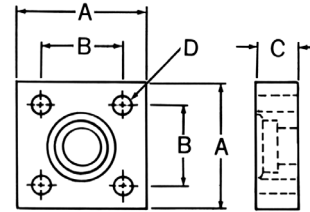

The JIS 4-bolt square flange connection is similar in concept to the SAE 4-bolt flange connection, except that

the JIS bolt pattern is square and the flange itself is different.

Size mm	Appx. inch size	Bolt size mm (bolt length for long (design))	Dim. "A" mm (inch)	Dim. "B" mm (inch)	Dim. "C" mm (inch)	Bolt hole dia "D" mm (inch)
12	1/2	M10 x 1.5 x 55 (80)	63 (2.48)	40 (1.57)	22 (0.87)	11 (0.43)
19	3/4	M10 x 1.5 x 55 (80)	68 (2.67)	45 (1.77)	22 (0.87)	11 (0.43)
25	1	M12 x 1.75 x 70 (100)	80 (3.15)	53 (2.09)	28 (1.10)	13 (0.51)
32	1 1/4	M12 x 1.75 x 70 (100)	90 (3.54)	63 (2.48)	28 (1.10)	13 (0.51)
38	1 1/2	M16 x 2.0 x 90 (130)	100 (3.94)	70 (2.76)	36 (1.42)	18 (0.71)
50	2	M16 x 2.0 x 90 (130)	112 (4.41)	80 (3.15)	36 (1.42)	18 (0.71)

JIS 210 Kgf/cm2 O-Ring

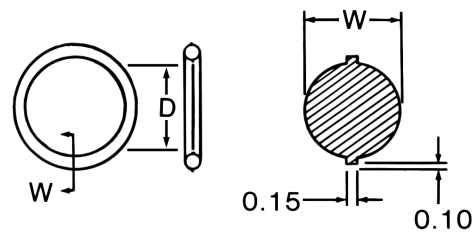

Nominal size mm	Dim. "D" mm	Dim. "W" mm
12	24.4 ± 0.15	3.1 ± 0.1
19	29.4 ± 0.15	3.1 ± 0.1
25	34.4 ± 0.15	3.1 ± 0.1
32	39.4 ± 0.15	3.1 ± 0.1
38	49.4 ± 0.15	3.1 ± 0.1
50	59.4 ± 0.15	3.1 ± 0.1

Fluid connector

O-Ring pilot thread sizes

A

O-Ring pilot thread sizes

This connection is common to air conditioning systems, both in vehicle and commercial applications. Both the male and female halves of the connections have a pilot, either long or short. The seal takes place by compressing an O-ring adjacent to the bead of the tube. The threads hold the connection together mechanically.

Inch size	Dash size	Male thread			Female thread		
		O.D. (inch) nominal thread	O.D. (inch) fraction	O.D. (inch) decimal	I.D. (inch) nominal thread	I.D. (inch) fraction	I.D. (inch) decimal
3/8	06	5/8 - 18	5/8	0.62	5/8 - 18	9/16	0.57
1/2	08	3/4 - 18	3/4	0.75	3/4 - 16	11/16	0.69
5/8	10	7/8 - 18	7/8	0.87	7/8 - 14	13/16	0.81
3/4	12	1 1/16 - 16	1 1/16	1.06	1 1/16 - 14	1	0.99

Inch size	Nominal tube size	Long pilot		Short pilot	
		Bead O.D.(inch)	Pilot length	Bead O.D. (inch)	Pilot length
3/8	06	0.52	0.28	0.52	0.19
1/2	08	0.64	0.39	0.64	0.19
5/8	10	0.77	0.39	0.77	0.19
3/4	12	0.91	0.39	0.91	0.19

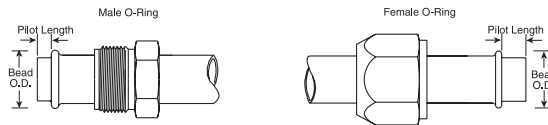

Thread engagement

Dimensions may vary due to tolerance conditions. Listed below are the thread engagement dimensions (B) which must be taken into consideration when making connection with ports or appropriate female adapters. The "B" dimension must be subtracted from the overall length (A) to insure proper connection.

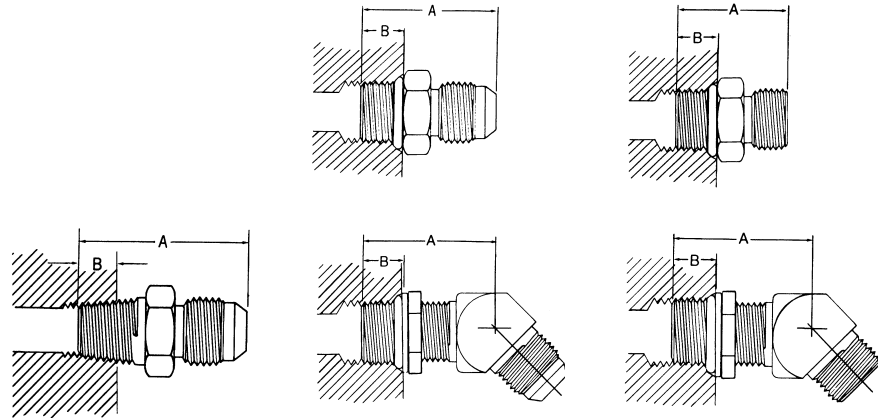

Dash size	Male pipe		SAE O-ring boss SAE J1926 with 37° flare J514		SAE O-ring boss SAE J1926 with ORS J1453	
	Straight and angled dimension "B"		Straight and adjustable dimension "B"		Straight and adjustable dimension "B"	
	mm	in	mm	in	mm	in
-02	6,4	0.25	—	—	—	—
-04	9,7	0.38	9,1	0.36	10,9	0.43
-05	—	—	9,1	0.36	10,9	0.43
-06	9,7	0.38	9,1	0.39	11,9	0.47
-08	12,7	0.50	10,9	0.43	14,0	0.55
-10	—	—	12,7	0.50	16,0	0.63
-12	15,7	0.62	15,0	0.59	18,5	0.73
-14	—	—	15,0	0.59	—	—
-16	17,5	0.69	15,0	0.59	18,5	0.73
-20	17,5	0.69	15,0	0.59	18,5	0.73
-24	17,5	0.69	15,0	0.59	18,5	0.73
-32	19,1	0.75	15,0	0.59	—	—

Allowable bulkhead thickness:

For ORS

Dash size	Hole diameter	ORS bulkhead thickness			
		Min		Max	
		mm	in	mm	in
-04	0.575 +.015/-0.000	5,1	0.20	12,7	0.50
-06	0.700 +.015/-0.000	5,1	0.20	15,0	0.59
-08	0.825 +.015/-0.000	5,6	0.22	15,0	0.59
-10	1.015 +.015/-0.000	5,8	0.23	15,0	0.59
-12	1.200 +.015/-0.000	6,4	0.25	15,0	0.59
-16	1.450 +.015/-0.000	6,4	0.25	15,2	0.60
-20	1.715 +.015/-0.000	6,4	0.25	15,2	0.60
-24	2.030 +.015/-0.000	6,4	0.25	15,2	0.60

For 37° Flare

Dash size	Hole diameter	37° bulkhead thickness straights				37° bulkhead thickness shapes			
		Min		Max		Min		Max	
		mm	in	mm	in	mm	in	mm	in
-03	0.391 +.016/-0.000	1,3	0.05	10,4	0.41	3,3	0.13	6,4	0.25
-04	0.453 +.016/-0.000	1,3	0.05	10,4	0.41	3,3	0.13	7,1	0.28
-05	0.516 +.016/-0.000	1,3	0.05	10,4	0.41	3,3	0.13	7,1	0.28
-06	0.578 +.016/-0.000	1,3	0.05	11,2	0.44	3,3	0.13	7,6	0.30
-08	0.766 +.016/-0.000	1,3	0.05	11,2	0.44	4,1	0.16	8,6	0.34
-10	0.891 +.016/-0.000	1,3	0.05	11,9	0.47	4,1	0.16	9,1	0.36
-12	1.076 +.016/-0.000	1,3	0.05	11,9	0.47	4,1	0.16	9,7	0.38
-16	1.328 +.016/-0.000	1,3	0.05	11,9	0.47	4,1	0.16	9,7	0.38
-20	1.656 +.031/-0.000	1,3	0.05	11,9	0.47	4,1	0.16	9,7	0.38
-24	1.906 +.031/-0.000	1,3	0.05	11,9	0.47	4,1	0.16	9,7	0.38

Fluid connectors

Metric thread dimensions, Conversion adapters

A

Metric thread dimensions

Conversion adapters

Sealing is achieved by means of an O-Ring, retaining washer and a properly machined port. The O-Ring is "captured" by the I.D. of the retaining washer. The port may be of the spot faced or a flat machined surface as long as the D6 dimension is met. Assembly instructions for adjustable type adapters are found at Lifesaver Fittings E-SROV-TS008-E.

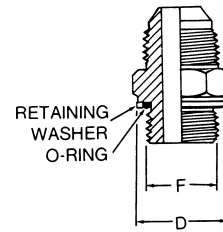
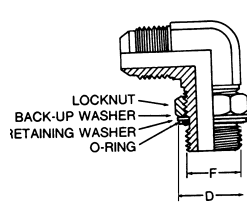

DIN 3852 large spot face

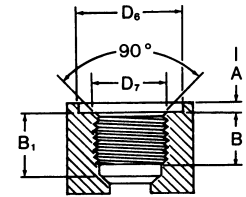

Equivalent to DIN 3852 form x

Thread size	M 10 x 1	M 12 x 1.5	M 14 x 1.5	M 16 x 1.5	M 18 x 1.5	M 20 x 1.5	M 22 x 1.5	M 26 x 1.5	M 27 x 2	M 33 x 2	M 42 x 2	M 48 x 2
F Thread Dia.	10.0	12.0	14.0	16.0	18.0	20.0	22.0	26.0	27.0	33.0	42.0	48.0
A max	1.0	1.5	1.5	1.5	2.0	2.0	2.5	2.5	2.5	2.5	2.5	2.5
B min (full thread)	12.0	12.0	12.0	12.0	12.0	14.0	14.0	16.0	16.0	18.0	20.0	22.0
B1 min	13.5	18.5	18.5	18.5	18.5	20.5	20.5	22.5	24.0	26.0	28.0	30.0
D max	15.7	18.7	19.7	23.2	26.2	28.2	30.2	35.2	36.2	43.2	52.7	58.7
D6 min	16.2	19.2	20.2	23.7	26.9	28.9	30.7	35.7	36.7	44.4	53.4	59.9
D7 max	10.2	12.2	14.2	16.2	18.2	20.2	22.2	26.2	27.2	33.3	42.3	48.3

BSPP (parallel) threads

Sealing is achieved by means of an O-Ring, retaining washer and a properly machined port.

The O-Ring is "captured" by the I.D. of the retaining washer. The compression is controlled by the thickness of the retaining washer.

The port may be of the spot faced or a flat machined surface as long as the D6 dimension is met.

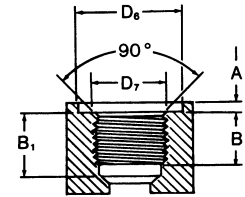
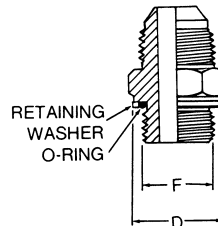
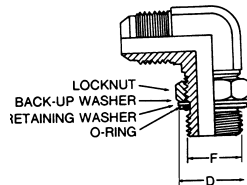

Thread size	G 1/8"-28		G 1/4"-19		G 3/8"-19		G 1/2"-14		G 3/4"-14		G 1"-11		G 1 1/4"-11		G 1 1/2"-11	
	mm	in	mm	in	mm	in	mm	in	mm	in	mm	in	mm	in	mm	in
F Thread Dia.	9,7	0.38	13,2	0.50	16,7	0.66	20,9	0.83	26,4	1.04	33,3	1.31	41,9	1.65	47,8	1.88
A max	1,0	0.04	2,0	0.08	2,05	0.10	2,5	0.10	2,5	0.10	2,5	0.10	2,5	0.10	2,5	0.10
B1 min (full thread)	8,0	0.31	12,0	0.47	12,0	0.47	14,0	0.63	16,0	0.63	18,0	0.71	20,0	0.79	22,0	0.87
B1 min	13,0	0.51	18,5	0.73	18,5	0.73	22,0	0.94	24,0	0.94	27,0	1.06	29,0	1.14	31,0	1.22
D max	15,7	0.62	19,7	0.78	24,0	0.94	28,7	1.38	35,2	1.38	43,2	1.70	52,7	2.07	58,7	2.31
D6 min	16,2	0.64	20,2	0.81	24,9	0.98	29,4	1.43	36,4	1.43	44,4	1.75	53,4	2.10	59,9	2.36
D7 max	10,0	0.39	13,4	0.53	16,9	0.67	21,2	1.05	26,7	1.05	33,6	1.32	42,3	1.67	48,2	1.90

BSPT (tapered) threads port sealing

Sealing is achieved by means of metal to metal deformation of the adapter and port threads.

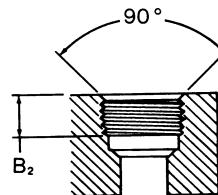

Thread size 11	R 1/8"-28		R 1/4"-19		R 3/8"-19		R 1/2"-14		R 3/4"-14		R 1"-11		R 1 1/4"-11		R 1 1/2"-11	
	mm	in	mm	in	mm	in	mm	in	mm	in	mm	in	mm	in	mm	in
B2 min (full thread)	5,5	0.22	8,5	0.33	8,5	0.33	10,5	0.41	13,0	0.51	14,5	0.57	17,0	0.67	17,0	0.67

Conversion table: Inch/Millimeter

Multiply inch x 25.4 =mm

Inches			Millimeters			Inches			Millimeters			Inches			Millimeters		
Fract.	Dec.	Dec.	Fract.	Dec.	Dec.	Fract.	Dec.	Dec.	Fract.	Dec.	Dec.	Fract.	Dec.	Dec.	Fract.	Dec.	Dec.
1/64	0.016	0.397	17/64	0.266	6.747	33/64	0.516	13.097	49/64	0.766	19.447						
1/32	0.031	0.794	9/32	0.281	7.144	17/32	0.531	13.494	25/32	0.781	19.844						
3/64	0.047	1.191	19/64	0.297	7.541	35/64	0.547	13.891	51/64	0.797	20.241						
1/16	0.063	1.588	5/16	0.313	7.938	9/16	0.563	14.288	13/16	0.813	20.638						
5/64	0.078	1.984	21/64	0.328	8.334	37/64	0.578	14.684	53/64	0.828	21.034						
3/32	0.094	2.381	11/32	0.344	8.731	19/32	0.594	15.081	27/32	0.844	21.431						
7/64	0.109	2.778	23/64	0.359	9.128	39/64	0.609	15.478	55/64	0.859	21.828						
1/8	0.125	3.175	3/8	0.375	9.525	5/8	0.625	15.875	7/8	0.875	22.225						
9/64	0.141	3.572	25/64	0.391	9.922	41/64	0.641	16.272	57/64	0.891	22.622						
5/32	0.156	3.969	13/32	0.406	10.319	21/32	0.656	16.669	29/32	0.906	23.019						
11/64	0.172	4.366	27/64	0.422	10.716	43/64	0.672	17.066	59/64	0.922	23.416						
3/16	0.188	4.763	7/16	0.438	11.113	11/16	0.688	17.463	15/16	0.938	23.813						
13/64	0.203	5.159	29/64	0.453	11.509	45/64	0.703	17.859	61/64	0.953	24.209						
7/32	0.219	5.556	15/32	0.469	11.906	23/32	0.719	18.256	31/32	0.969	24.606						
15/64	0.234	5.953	31/64	0.484	12.303	47/64	0.734	18.653	63/64	0.984	25.003						
1/4	0.250	6.350	1/2	0.500	12.700	3/4	0.750	19.050	1	1.000	25.400						

Conversion table: Pressure

(Per SAE J517 Section A)

Mpa	Bar	PSI	Mpa	Bar	PSI	Mpa	Bar	PSI	Mpa	Bar	PSI
0.25	2.5	35	4.2	42	600	20	200	2900	77	770	11000
0.3	3	45	4.3	43	625	21	210	3000	78	780	11250
0.35	3.5	50	4.9	49	700	22.4	224	3200	80	800	11600
0.4	4	56	5	50	725	22.7	227	3250	84	840	12000
0.4	4	62	5.2	52	750	24.5	245	3500	87	870	12500
0.5	5	70	5.6	56	800	28	280	4000	98	980	14000
0.6	6	90	6.1	61	875	29.7	297	4250	112	1120	16000
0.7	7	100	7	70	1000	31.5	315	4500	119	1190	17000
0.8	8	112	7.8	78	1125	33.5	335	4800	122	1220	17500
0.85	8.5	125	8.4	84	1200	35	350	5000	140	1400	20000
1	10	140	8.7	87	1250	38.5	385	5500	157	1570	22500
1.05	10.5	150	9.8	98	1400	40	400	5800	160	1600	23200
1.25	12.5	180	10	100	1450	42	420	6000	168	1680	24000
1.4	14	200	10.5	105	1500	43.5	435	6250	175	1750	25000
1.6	16	225	11.2	112	1600	45.5	455	6500	210	2100	30000
1.7	17	250	11.3	113	1625	49	490	7000	245	2450	35000
2.1	21	300	12.2	122	1750	52.5	525	7500	280	2800	40000
2.4	24	350	14	140	2000	56	560	8000	315	3150	45000
2.6	26	375	15.7	157	2250	59.5	595	8500	350	3500	50000
2.8	28	400	16.8	168	2400	61	610	8750			
3.5	35	500	17.5	175	2500	63	630	9000			
3.9	39	565	19.2	192	2750	70	700	10000			

A new method for calculating the equivalent metric conversion to Mpa from psi was utilized. This method provides an extremely easy and consistent method of

conversion to arrive at a rounded metric units using 7 Mpa for each 1000 psi. The resulting Mpa pressure in never more than 1.7% higher than the mathematically

correct Mpa unit when the pressure in higher than 250 psi. All operating pressures of SAE J517 hoses are above 250 psi except for most of 100R4 and the

76mm (-48) and larger sizes of 100R5. Therefore all files of previous test results should not be compromised

Assembly instructions

Assembly torque

A

Recommended parallel connection assembly torque

Eaton recommends that a torque wrench be used to assure proper fitting assembly of these connections.

Straight thread O-Ring boss low pressure with 37° (SAEJ514)

Dash size	Thread size (inches)	Jam nut or straight fitting torque lb.-ft.	Jam nut or straight fitting torque newton meters
-03	3/8-24	8-9	12-13
-04	7/16-20	13-15	18-20
-05	1/2-20	14-15	19-21
-06	9/16-18	23-24	32-33
-08	3/4-16	40-43	55-57
-10	7/8-14	43-48	59-64
-12	1 1/16-12	68-75	93-101
-14	1 3/16-12	83-90	113-122
-16	1 5/16-12	112-123	152-166
-20	1 5/8-12	146-161	198-218
-24	1 7/8-12	154-170	209-230
-32	2 1/2-12	218-240	296-325

The values listed are for steel connections. Contact Eaton for torque values for other materials.

Straight thread O-Ring boss high pressure with ORS (J1453)

Dash size	Thread size (inches)	Jam nut or straight fitting torque lb.-ft.	Jam nut or straight fitting torque newton meters
-03	3/8-24	8-10	11-13
-04	7/16-20	14-16	20-22
-05	1/2-20	18-20	24-27
-06	9/16-18	24-26	33-35
-08	3/4-16	50-60	68-78
-10	7/8-14	72-80	98-110
-12	1 1/16-12	125-135	170-183
-14	1 3/16-12	160-180	215-245
-16	1 5/16-12	200-220	270-300
-20	1 5/8-12	210-280	285-380
-24	1 7/8-12	270-360	370-490

ORS

Dash size	Thread size (inches)	Swivel nut torque lb.-ft.	Swivel nut torque newton meters
-04	9/16-18	10-12	14-16
-06	11/16-16	18-20	24-27
-08	13/16-16	32-35	43-47
-10	1-14	46-50	62-68
-12	1 3/16-12	65-70	88-95
-16	1 7/16-12	92-100	125-136
-20	1 11/16-12	125-140	170-190
-24	2-12	150-165	204-224

SAE 37° (JIC)

Dash size	Thread size (inches)	Swivel nut torque lb.-ft.	Swivel nut torque newton meters
-04	7/16-20	11-12	15-16
-05	1/2-20	15-16	20-22
-06	9/16-18	18-20	24-28
-08	3/4-16	38-42	52-58
-10	7/8-14	57-62	77-85
-12	1 1/16-12	79-87	108-119
-16	1 5/16-12	108-113	148-154
-20	1 5/8-12	127-133	173-182
-24	1 7/8-12	158-167	216-227
-32	2 1/2-12	245-258	334-352

Metric

Thread size	Straight adapter or locknut torque	
	lb.-ft.	Newton meters
M10 x 1	13-15	18-20
M12 x 1.5	15-19	20-25
M14 x 1.5	19-23	25-30
M16 x 1.5	33-40	45-55
M18 x 1.5	37-44	50-60
M20 x 1.5	52-66	70-90
M22 x 1.5	55-70	75-95
M26 x 1.5	81-96	110-130
M27 x 2	96-111	130-150
M33 x 2	162-184	220-250
M42 x 2	170-192	230-260
M48 x 2	258-347	350-470

BSPP

Nominal thread size	Straight adapter or locknut torque	
	lb.-ft.	Newton meters
G 1/8-28	13-15	18-20
G 1/4-19	19-23	25-30
G 3/8-19	33-40	45-55
G 1/2-14	55-70	75-95
G 3/4-14	103-118	140-160
G 1-11	162-184	220-250
G 1 1/4-11	170-192	230-260
G 1 1/2-11	258-347	350-470

***"G" denotes parallel threads, other than ISO 6149. (Port connection only)

Assembly instruction tips

Terms

- Skive—Removal of the cover material exposing the reinforcement prior to fitting assembly.
- Dash Size—The hose or fitting size expressed in 1/16 of an inch. The numerator of a fraction whose denominator is 16. Example: -8 or -08 is $8/16" = 1/2"$
- Nipple—The part of a hose fitting that goes into the hose tube.
- Socket—The part of a hose fitting that goes over the hose cover or reinforcement.
- Mandrel—A round, properly sized, steel bar used for support during assembly of the fitting or skiving the hose cover.
- Annular Rings—A series of concentric rings inside the socket.

Reusable fitting tips to remember for easy assembly

- Part numbers and dash sizes are indicated on fitting sockets.
- It is essential the fitting be mated with a compatible hose style with the same dash size.
- Reusable fittings that have a notch in the socket serve as a reference for the cover skiving length.
- Familiarize yourself with the assembly instructions before you start to make an assembly.
- For hoses that require skiving, be sure to skive the hose to the proper length and down to the wire reinforcement.
- Use Aeroquip 222070 hose assembly lube liberally on both the inside of the hose and on the fitting nipple. (Check for compatibility.)
- Always cut hose square
- For volume production of hose assemblies, use Eaton Assembly Equipment.

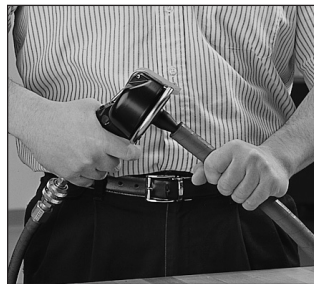

Cutting the hose

1. To determine the "J" length (cut length of hose) from "OA" (overall length) deduct "D" dimensions of both end fittings. Consult fitting information pages for "D" dimensions. For hose assemblies with SOCKETLESS® fittings, add 1/2" to "J" length.

Tip: If the old Aeroquip® assembly was the right length, simply remove the hose fittings and measure the hose.

2. Cut the hose square.
3. Clean the hose bore.

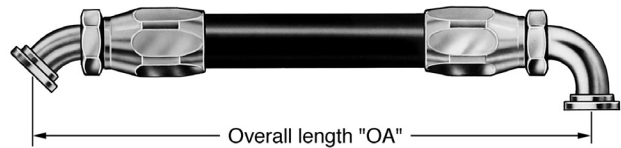
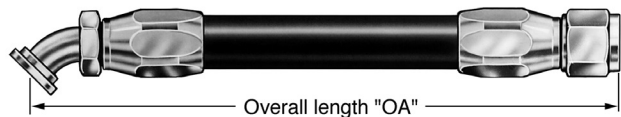
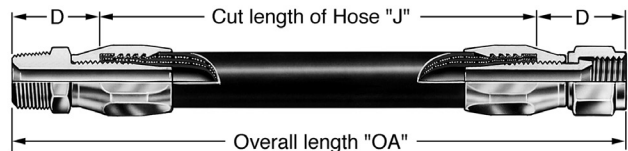

Phase angle (offset)

When making double elbow assemblies, the following steps should be followed to obtain the desired angle between elbows. Tighten both elbows to maximum allowable gap between socket and nipple hex. Start to position for relative angle between elbows. Finish assembly by adjusting both elbows. Backing off to get desired angle should be avoided.

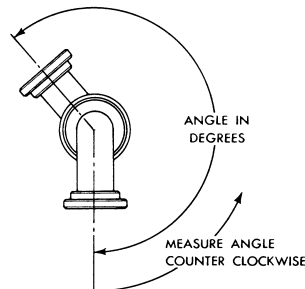

Assembly instructions

Maintenance

A

Cleaning, inspection, testing and storage

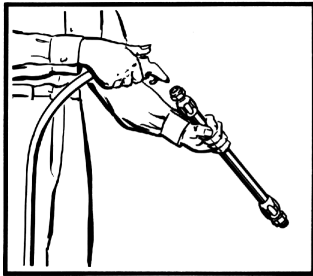

Clean



Inspect

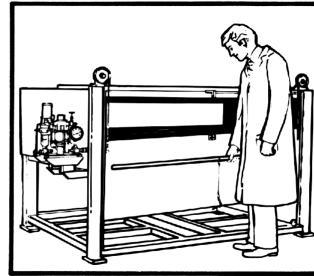

Proof test - hydrostatic

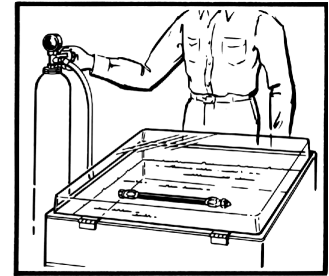

Proof test - pneumatic

Maintenance

Hose assemblies in operation should be inspected frequently for leakage, kinking, abrasion, corrosion or any other signs of wear or damage. Worn or damaged hose assemblies should be replaced immediately.

Clean

At minimum a hose assembly should be blown out with clean compressed air. Eaton recommends using the **Eaton Projectile Cleaning System** (FT1455 Series).

Assemblies may be rinsed out with mineral spirits if the tube stock is compatible with oil, otherwise hot water at +150°F max. may be used.

Inspect

Examine hose assembly internally for cut or bulged tube, obstructions, and cleanliness.

Check for proper gap between nut and socket or hex and socket. Nuts should swivel freely. Cap the ends of the hose with plastic covers to keep clean.

Proof test – hydrostatic

The hose assembly should be hydrostatically tested at twice the recommended working pressure of the hose.

Test pressure should be held for not more than one minute and not less than 30 seconds. When test pressure is reached, visually inspect hose assembly for: a) Any leaks or signs of weakness. b) Any movement of the hose fitting in relation to the hose. Any of these defects are cause for rejection.

(See Assembly Equipment Section for Eaton Proof Test Stands.)

Proof test – pneumatic

Hose assemblies intended for gas or air service should be tested with air or nitrogen at 100 psi with the assembly immersed in water. Random bubbles may appear over the hose and fitting area when assembly is first pressurized. This should not be construed as a defect. However, if the bubbles persist in forming at a steady rate at any particular point on the hose, the assembly should be rejected.

Caution: Testing should be conducted in approved test stands with adequate guards to protect the operator.

Storage and handling

Hose should be stored in a dark, dry atmosphere away from electrical equipment, and the temperature should not exceed +90°F. Storage in the original shipping container is preferred.

Hose and reusable fittings

Standard (mandrelless) reusable fittings with single wire braid, multiple textile braid, hydraulic and LPG hose.

FC234, FC300, FC321, FC350, FC355, 1503, 2580, 2651

(for fittings requiring mandrel, see page A-58)

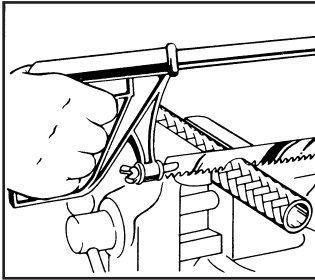

Step 1

Cut hose square with cut-off wheel.

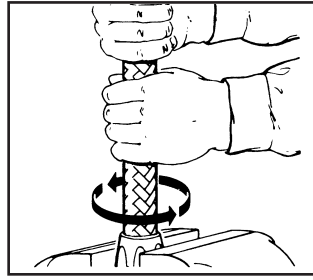

Step 2

Put socket in vise.
Screw hose counterclockwise into socket until it bottoms.
Back off 1/4 turn.

When assembling long lengths of hose, it may be preferred to put hose in vise just tight enough to prevent from turning, and screw socket into the hose counterclockwise until it bottoms.

Back off 1/4 turn.

Back off FC300, FC350 and FC355 1/4 to 1/2 turn.

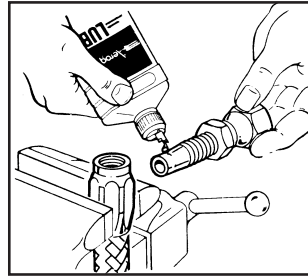

Step 3

Lubricate nipple and threads **LIBERALLY**. Use heavy oil or Aeroquip® 222070 hose assembly lube.

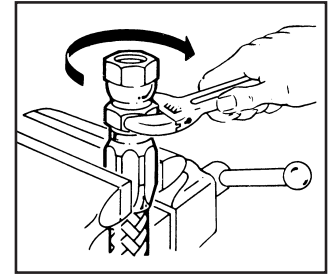

Step 4

Screw nipple clockwise into socket and hose. Leave 1/32" to 1/16" clearance between nipple hex and socket.

Recommendations for cleaning, inspection and testing are summarized on page A-52. Disassemble in reverse order.

SOCKETLESS® fittings with textile braid low pressure hose

FC332, FC647, 2556, 2565, 2575, H201, 35FH

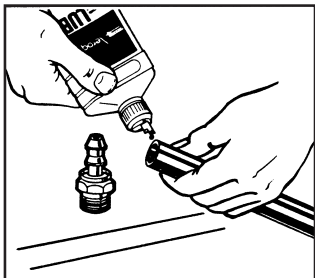

Step 1 to assemble

Cut hose to required length with a sharp knife. Oil inside of hose and outside of nipple liberally.

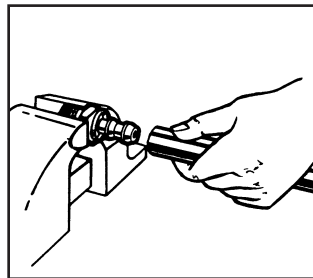

Step 2

Push hose on fitting until hose end bottoms underneath protective cap as shown. For quantity production use a SOCKETLESS fitting assembly machine. Recommendations for cleaning, inspection and testing are summarized on page A-52.

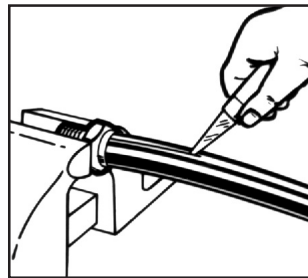

Step 1 to disassemble

Slit hose lengthwise from protective cap to end of nipple.

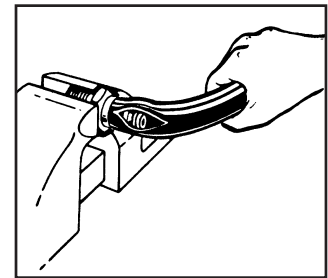

Step 2

Bend hose, then snap hose off with a quick tug.

Assembly instructions

Hose and reusable fittings

A

Hose and reusable fittings

Standard reusable fittings with Hi-Pac and two wire braid hose

FC310, FC510, 2781

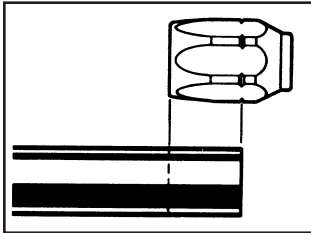

Step 1

Cut hose to length required using a cut-off wheel. Clean hose bore.

Hose must be stripped of its rubber cover before inserting in socket. Locate skiving point by putting hose end next to socket as shown. Measure from hose end of socket to notch on socket.

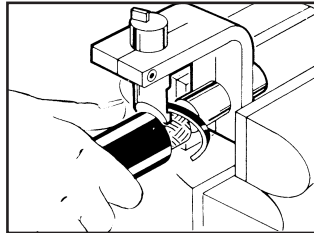

Skive Tool

Use the correct size FT1229 hose cover skiving tool. Mount the tool in a vise. Push the hose over the mandrel. Rotate the hose clockwise until it bottoms or secure hose in a vise and attach FT1279 auger to the skive tool. Insert mandrel into the hose and rotate clockwise until it bottoms.

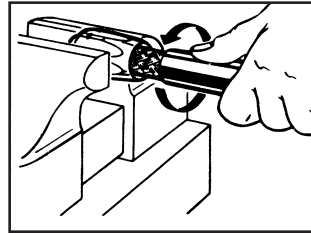

Step 2

Put socket in vise.

Screw hose into socket counterclockwise until it bottoms.

When assembling long lengths of hose, it may be preferred to put hose in vise just tight enough to prevent from turning, and screw socket onto the hose counterclockwise until it bottoms.

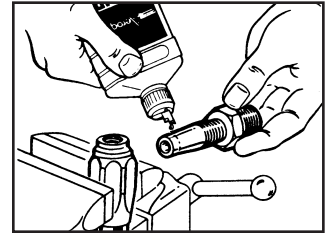

Step 3

Lubricate nipple threads and inside of hose liberally. Use heavy oil or Eaton 222070 hose assembly lube.

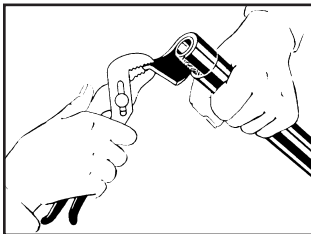

Step 1A

Skive Hose

By Hand: Cut rubber cover around down to wire reinforcement. Slit lengthwise. Raise flap and pull off with pliers. Clean excess rubber off wire reinforcement with wire brush or soft wire wheel. Do not fray or flare wire reinforcement when brushing.

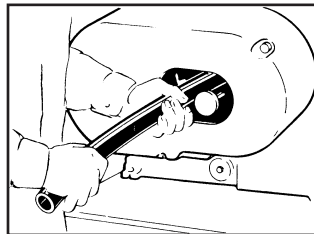

Machine

Use the S1102 cut-off and skiving machine. Consult the owners manual. Select the correct mandrel. Turn on the machine. Put the hose over the mandrel and rotate.

Note: When skiving, remove the rubber cover until the wire reinforcement is exposed around the circumference of the hose.

Note: Sockets for hose fittings in the -16, -24 and -32 sizes are furnished with internal annular grooves in place of helical grooves (all FC310 and FC510 hose sockets are annular grooved). Install socket by pushing hose into socket with a back and forth rocking and twisting motion until hose bottoms on shoulder of socket.

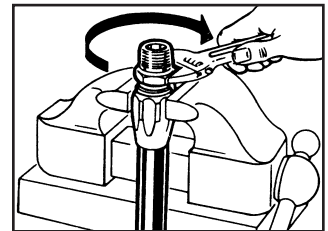

Step 4

Screw nipple clockwise into socket and hose.

Leave 1/32" to 1/16" clearance between nipple hex and socket.

Recommendations for cleaning, inspection and testing are summarized on page A-52. Disassemble in reverse order.

Hose and reusable fittings

Standard reusable fittings with four spiral wire hose

GH493, FC736

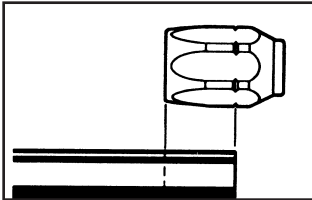

Step 1

Cut hose to length required using a cut-off wheel. Clean hose bore.

Hose must be stripped of its rubber cover before inserting into socket. Locate skiving point by putting hose end next to socket as shown. Measure from hose end of socket to notch on socket.

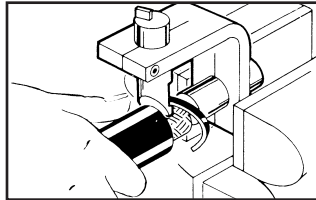

Skive Tool

Use the correct size Eaton FT1229 hose cover skiving tool. Mount the tool in a vise. Push the hose over the mandrel. Rotate the hose clockwise until it bottoms or secure hose in a vise and attach FT1279 auger to the skive tool. Insert mandrel into the hose and rotate clockwise until it bottoms.

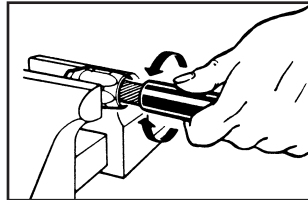

Step 2

Sockets for hose fittings are furnished with internal annular grooved design. Install socket by pushing hose into socket with a back and forth rocking and clockwise twisting motion until hose bottoms on shoulder of socket.

An alternate method is to insert the hose in a vise. Install socket by pushing onto the hose with a back and forth rocking and clockwise twisting motion until the hose bottoms on the shoulder of socket.

A rawhide hammer or similar tool may be used to tap the socket onto the hose but avoid damage to internal socket threads. Be sure not to damage hose cover or wire reinforcement.

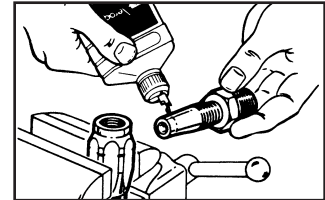

Step 3

Liberalily lubricate nipple threads and inside of hose. Use heavy weight oil or Aeroquip® 222070 hose assembly lube.

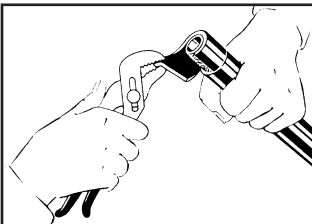

Step 1A

Skive hose by hand

Cut rubber cover around down to wire reinforcement with a knife. Slit lengthwise. Raise flap and pull off with pliers. Clean excess rubber off wire reinforcement with wire brush or soft wire wheel. Do not fray or flare wire reinforcement when brushing.

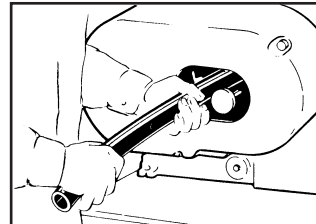

Machine

Use the Eaton S1102 cut-off and skiving machine. Consult the owners manual. Select the correct mandrel. Turn on the machine. Put the hose over the mandrel and rotate counterclockwise.

Note: when skiving, remove the rubber cover until the wire reinforcement is exposed around the circumference of the hose.

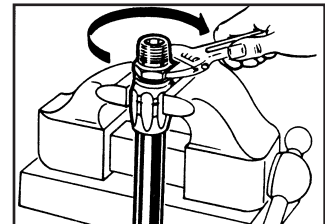

Step 4

Screw nipple clockwise into socket and hose. Leave a 1/32" to 1/16" clearance between nipple hex and socket.

Recommendations for cleaning, inspection and testing are summarized on page A-52. Disassemble in reverse order.

Assembly instructions

Hose and reusable fittings

A

Hose and reusable fittings

Thru-the-cover style reusable fittings with hose

GH663, GH793

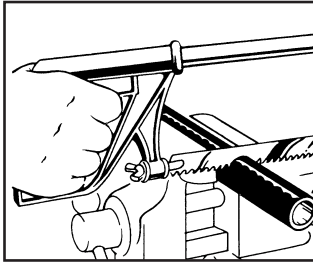

Step 1

Cut hose to length required using a cut-off machine. Clean hose bore.

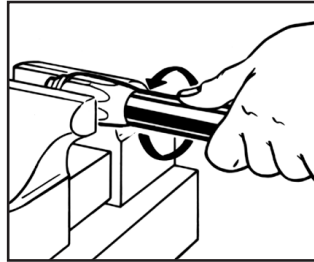

Step 2

Liberaly lubricate hose cover with Aeroquip® 222070 hose assembly lube.

Place socket in vise and turn hose into socket counterclockwise until it bottoms.

When assembling long lengths of hose, it may be preferred to put hose in vise just tight enough to

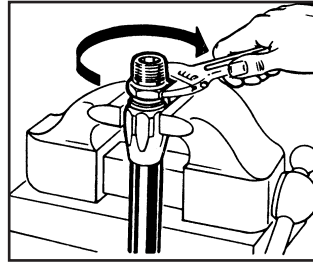

prevent from turning, and screw socket onto the hose counterclockwise until it bottoms.

Step 3

Liberaly lubricate nipple threads and inside of hose. Use heavy weight oil or Aeroquip® 222070 hose assembly lube.

Step 4

Screw nipple clockwise into socket and hose. Leave 1/32" to 1/16" clearance between nipple hex and socket.

Recommendations for cleaning, inspection and testing are summarized on page A-52. Disassemble in reverse order.

Standard (mandrelless) reusable fittings with engine, air brake and railroad air brake hose

1531, 1531A, 2550, 2554, 2570 (for fittings requiring mandrel, see page A-58)

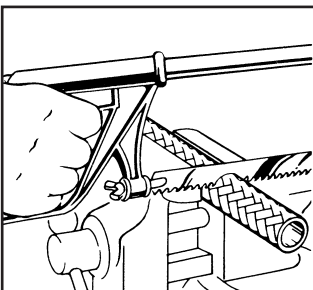

Step 1

Cut hose square to length required using a cut-off wheel. Clean hose bore.

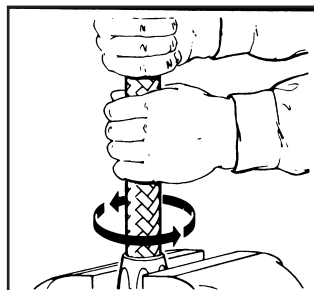

Step 2

Put socket in vise. Screw hose counterclockwise into socket until hose bottoms. Back off 1/4 turn.

When assembling long lengths of hose, it may be preferred to put hose in vise just tight enough to prevent from turning, and screw socket into the hose counterclockwise until it bottoms. Back off 1/4 turn.

Note: For 2550, 2554 and 2570 hose: Sockets for these hose fittings are furnished with internal annular grooved design. Install

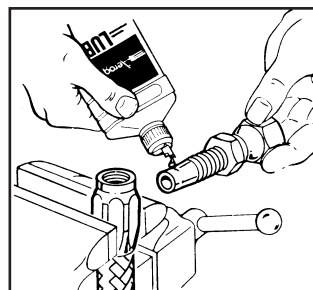

socket by pushing hose into socket with a back and forth rocking and twisting motion until hose bottoms on shoulder of socket. Back off 1/4 turn.

Step 3

Lubricate nipple threads and inside of hose liberally with Aeroquip® 222070 hose assembly lube or heavy weight oil.

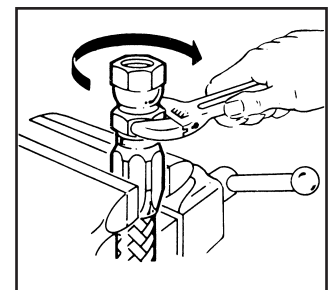

Step 4

Screw nipple clockwise into socket and hose. Leave a 1/32" to 1/16" clearance between nipple hex and socket.

Recommendations for cleaning, inspection and testing are summarized on page A-52. Disassemble in reverse order.

Hose and reusable fittings

“Super Gem”® fittings with PTFE hose

FC465, 2807, 2808

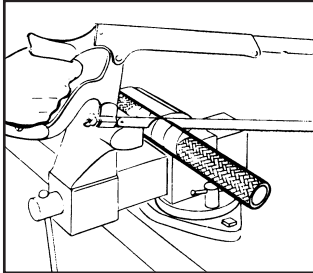

Step 1

Wrap hose with masking tape at cut-off point and cut square to length through taped area using a cut-off machine. Remove tape and trim any loose wires flush with tube stock. Any burrs on the bore of the tube stock should be removed with a knife. Clean the hose bore. Sometimes wire braid will tend to “neck down” on one end and flare out, on the opposite end. This is a characteristic of wire braid hose and can be used to an advantage in the assembly of the “super gem” sockets. Slip two sockets back to back over the “necked down” end of the hose.

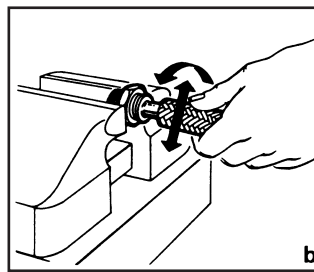
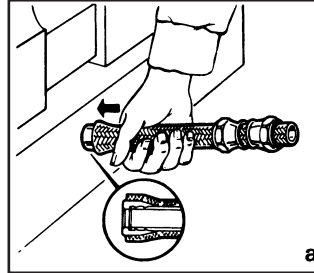

Step 2

- a. Push the sleeve over the end of the tube and under the wire braid by hand. Complete positioning of the sleeve by pushing the hose end against a flat surface. Visually inspect to see that tube stock butts against the inside shoulder of the sleeve.
- b. Set the sleeve barbs into the PTFE tube by using assembly tool FT1038A or working the hose bore over the nipple into the end of the sleeve and tube. Assembly kit FT1081 is also available.

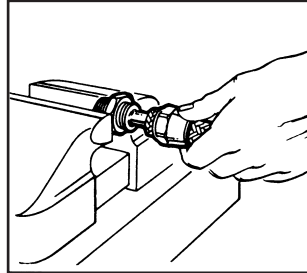

Step 3

Lubricate nipple and socket threads. For stainless steel fittings, use a molydisulfide base lubricant (e.g., Molykote* Type G), lubricants containing chloride are not recommended. Other material combinations use standard petroleum lubricants. Hold the nipple with hex in vise. Push hose over nipple with twisting motion until seated against nipple chamfer. Push socket forward and hand start threading of socket to nipple.

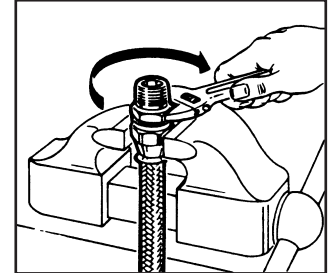

Step 4

Wrench tighten nipple hex until clearance with socket hex is 1/32” or less. Tighten further to align corners of nipple and socket hexes. Recommendations for cleaning, inspection and testing are summarized on page A-52.

To disassemble: Unscrew and remove nipple; slide socket back on hose by tapping against flat surface; remove sleeve with pliers. New sleeves are recommended upon reuse of the fitting.

*Molykote Type G is a registered trademark of the Dow Corning Corporation.

Assembly instructions

Hose and reusable fittings

A

Hose and reusable fittings

Mandrel type fittings— standard reusable fittings with single wire braid, multiple textile braid, hydraulic, LPG hose, engine and air brake hose

FC234, FC300, FC321, FC350, FC355, 1503, 2580, 2651

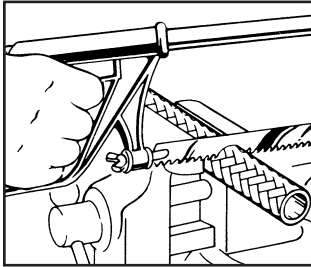

Step 1

Cut hose square to length required using a cut-off wheel. Clean hose bore.

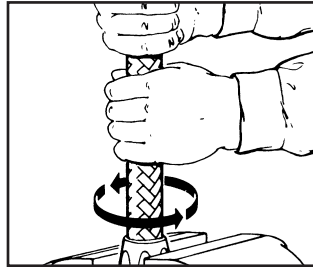

Step 2

Put socket in vise. Screw hose counterclockwise into socket until hose bottoms. Back off 1/4 turn.

When assembling long lengths of hose, it may be preferred to put hose in vise just tight enough to prevent from turning, and screw socket into the hose counterclockwise until it bottoms. Back off 1/4 turn.

Back off FC300, FC350 and FC355 hose 1/4 to 1/2 turn.

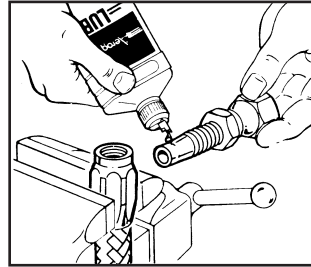

Step 3

MALE ENDS: Push assembly tool into nipple.

SWIVEL ENDS: Tighten nipple and nut on assembly tool.

Lubricate nipple, mandrel and inside of hose liberally. Use heavy oil or Eaton 222070 hose assembly lube.

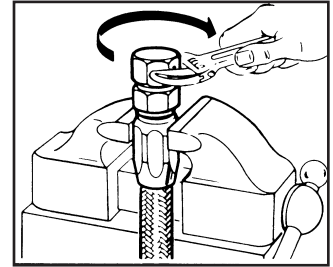

Step 4

MALE ENDS: Screw nipple clockwise into socket and hose. Leave a 1/32" to 1/16" clearance between nipple hex and socket.

SWIVEL ENDS: Screw nipple clockwise into socket and hose. Leave 1/32" to 1/16" clearance between nut and socket.

Recommendations for cleaning, inspection and testing are summarized on page A-52. Disassemble in reverse order.

Nipple and clamp with suction hose

2661, FC619

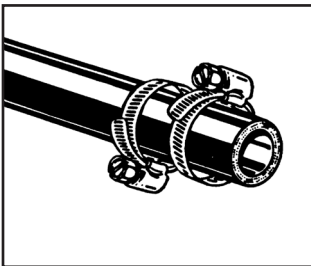

Step 1

Cut hose square to length required. Clean hose bore. Slide band clamp over hose cover.

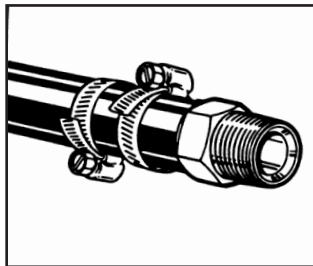

Step 2

Insert nipple into hose until hose end bottoms on nipple shoulder.

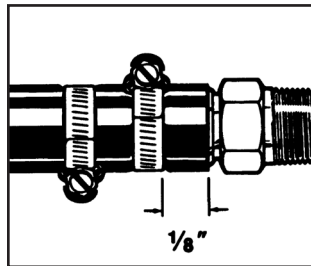

Step 3

Evenly space two band clamps from end of hose to end of nipple (see above). The band clamps should be tightened 180° from each other. Tighten clamps to 100 in-lbs. Recommendations for cleaning, inspection and testing are summarized on page A-52.

Accessories

Steel protective coil sleeve

900705

Steel protective coil spring

900564

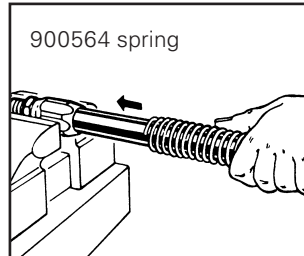
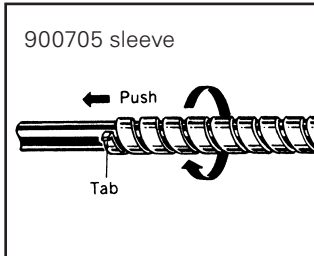

Step 1

Follow the appropriate assembly instructions through the assembly of one end fitting. Insert one end fitting in vise.

Step 2

Cut coil length. Coil should be cut to overall assembly length "OA" minus the sum of the overall length of each end fitting. ("A" dimension).

Step 3

3a) 900705 Steel Protective Coil Sleeve

The hose and the coil should be held straight. Taping or capping the hose end can prevent frayed wire ends from snagging on the coil. Bend one end to the coil outward to form a slight tab to assist grasping. (Cut off or bend back when installation is complete.) Hold the tab

with the thumb of one hand while twisting the coil clockwise approximately one foot back from the coil tab. When the coil opens up sufficiently, slip the tab end to the coil over the hose. Move the coil onto the hose by pulling at the tab end while pushing with the other hand. Be careful not to exceed the resiliency of the coil by stretching it too far.

3b) 900564 Steel Protective Coil Spring

Slide coil over hose.

Step 4

Proceed with assembly of second end fitting.

Plastic coil sleeve

900952

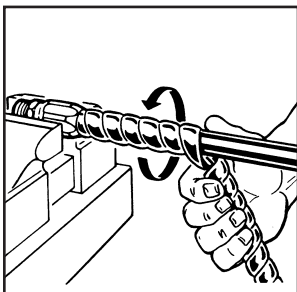

Step 1

Follow the appropriate hose assembly instructions through the assembly of both end fittings. Insert end fitting in vise.

Step 2

Cut coil length. Coil should be cut to overall assembly length "OA" minus the sum of the overall length of each end fitting. ("A" dimension).

Step 3

Wrap the coil on the hose.

Assembly instruction

Accessories

A

Accessories

Internal support coils

222005, 222022

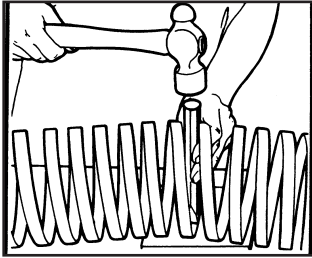

Step 1

Cut coil length. The coils should be cut to the hose length, minus the nipple intrusion. For any given hose assembly the support coil length equals the overall hose assembly length minus the sum of the overall lengths of each end fitting. ("A" dimensions.)

Small size of the coil can usually be cut with strap cutters or sheet metal shears. The larger sizes are best cut with a heavy sharp chisel or bolt cutter. With small sizes skip directly to Step 3.

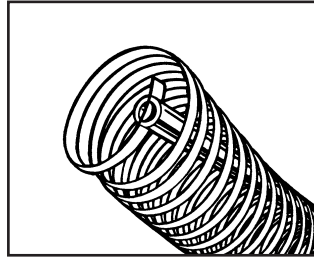

Step 2

Compress the coil (large sizes only). It is necessary to reduce the coil diameter slightly in order to insert it into the hose. The easiest approach is to use a length of pipe with a notch cut in one end. Clamp the plain end of the pipe in a vise, slide the coil over the pipe and insert the free end of the coil into the notched end of the pipe. Then clamp the coil and pipe firmly together. Twist the coil to compress it prior to installation into the hose.

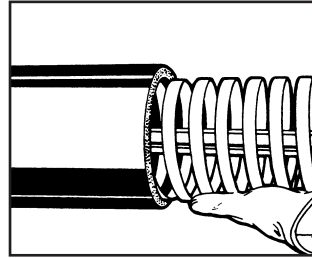

Step 3

Small sizes: The coil can be worked into the hose by hand without difficulty. Remove all burrs from the coil prior to insertion. This will prevent cutting of the hose tube. Position the coil midway between hose ends.

Large sizes: With the pipe still in position, as in Step 2, assemble the hose over the coil. With the coil fully centered in the hose, remove the pipe and clamp.

Firesleeve

624

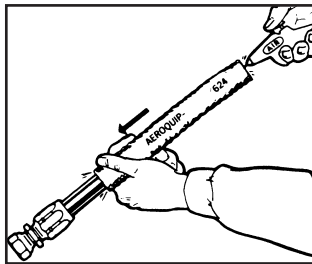

Step 1

Follow the appropriate hose assembly instructions through the assembly of one end fitting. Cut firesleeve to same length as hose; using Firesleeve End Dip (AE13702-003) dip ends of firesleeve to a depth of three quarters of an inch and allow to dry at room temperature.

Start firesleeve over cut end of hose.

Notes: If applying sleeve over PTFE or stripped cover assemblies, wrap exposed wire with tape. Grasp sleeve and slip over the hose assembly as illustrated.

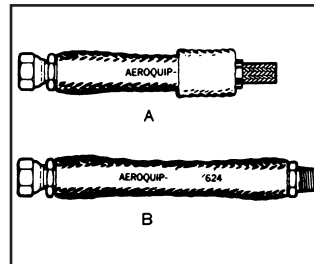

Step 2

Skin sleeve back from cut end of hose enough to allow assembly of second end fitting. (2A)

Then center sleeve so that it completely covers both sockets. (2B)

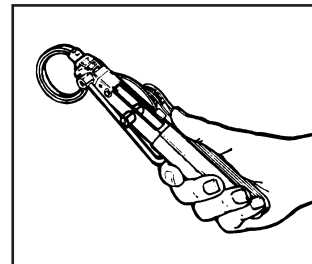

Step 3

Insert tail of band clamp into hand clamping tool.

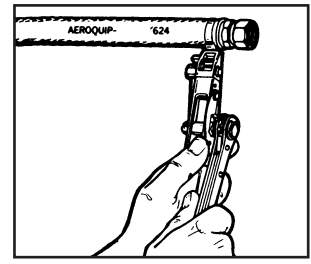

Step 4

Position band clamp over sleeve as shown and then draw tight with hand tool. Remove tool and cut free end of band clamp. Repeat on other end of assembly. To complete, bend protruding tail of clamp over clamp buckle. Also repair any scuffs or minor abrasions of firesleeve by brush application of End Dip AE13702-003.

Hydraulic hose

Braided hose – Premium

Meets SAE100R1 TYPE S, 100R17, EN853 1SN, 1ST, EN857 1SC

GH681	B-7
FC839B	B-8
GH194	B-9

Meets SAE100R2 TYPE S, 100R16 100R19, EN853 2SN, 2ST, EN857 2SC

GH781	B-10
FC735	B-11
GH195	B-12
GH120	B-13

Spiral hose – Premium

Meets SAE100R12, EN856 R12, 4SP

GH493	B-14
FC736	B-15
EC525	B-16

Meets SAE 100R13, EN856 R13

FC500	B-17
FC273B	B-18
EC810	B-19

Meets SAE 100R15, EN856 R15, 4SH

EC600	B-20
FC850	B-21

Braided hose – Other

FC639	B-22
GH663	B-23
FC849	B-24
FC849B	B-25
FC310	B-26
FC510	B-27
GH793	B-28
2681	B-29
2781	B-30
FC611	B-31
FC693	B-32
EC502	B-33
FC579	B-34
EC230	B-35

Spiral hose – Other

FC254	B-36
GH506	B-37
FC606	B-38
GH466	B-39
FC636	B-40
EC910	B-41

Suction hose – Specialty

FC619	B-42
2661	B-43

Thermoplastic hose

3130	B-44
3740	B-45
37AL	B-46
3R80	B-47
3E80	B-48
30CT	B-49
3V10	B-50
FVE0	B-51
3130, 37AL and 30CT	B-52

B



Hydraulic hose

Braided hose – Premium

B

Braided hose – Premium

Meets SAE 100R1 Type S, SAE 100R17, EN853 1SN, 1ST, EN857 1SC

GH681 Premium **B-7**



FC839B Premium abrasion **B-8**



GH194 Premium high temperature **B-9**



Meets SAE 100R2 Type S, 100R16, 100R19, EN853 2SN, 2ST, EN857 2SC

GH781 Premium **B-10**



FC735 Premium abrasion **B-11**



GH195 Premium high temperature **B-12**



GH120 Premium low temperature **B-13**



Spiral hose – Premium

Meets SAE 100R12, EN856 R12, 4SP

GH493 Premium **B-14**



FC736 Premium abrasion **B-15**



EC525 Premium high temperature **B-16**



Meets SAE 100R13, EN856 R13

FC500 Premium **B-17**



FC273B Premium abrasion **B-18**

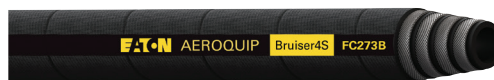

EC810 Premium low temperature **B-19**

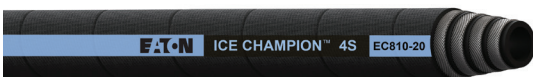

Meets SAE 100R15, EN856 R15, 4SH

EC600 Premium **B-20**



EC850 500 Bar **B-21**

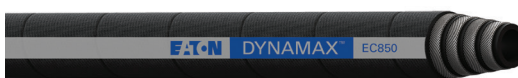

Hydraulic hose

Braided hose – Other

B

Braided hose – Other

FC639 **SAE 100R17** **B-22**



GH663 **SAE 100R1AT Premium** **B-23**



FC849 **SAE 100R19** **B-24**



FC849B **SAE 100R19 Premium abrasion** **B-25**

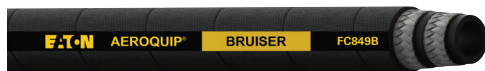

FC310 **SAE 100R16** **B-26**



FC510 **SAE 100R16 High temperature** **B-27**



GH793 **SAE 100R2AT, EN853 2SN** **B-28**



2681 **SAE 100R1A, EN853 1ST** **B-29**



2781 **100R2A** **B-30**



FC611 **Specialty** **B-31**



FC693 **EPDM Two-wire braid** **B-32**



EC502 **LifeSense®** **B-33**

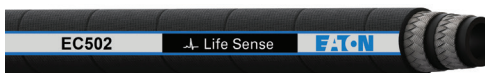

FC579 **Specialty** **B-34**



EC230 **SAE 1002AT Large bore** **B-35**



Spiral hose – Other

FC254 EN856 4SP **B-36**



GH506 EN856 4SH **B-37**



FC606 Specialty **B-38**



GH466 SAE 100R15 **B-39**



FC636 SAE 100R12 **B-40**



EC910 Specialty **B-41**



Suction hose

FC619 SAE 100R4 1/2 SAE bend radius **B-42**



2661 SAE 100R4 High temperature suction **B-43**



Hydraulic hose

Thermoplastic hose

B

Meets SAE 100R7

3130 Medium pressure **B-44**



3740 Medium pressure, non-conductive **B-45**



37AL Medium pressure, non-conductive **B-46**



Meets SAE 100R8

3R80 High pressure **B-47**



3E80 High pressure, non-conductive **B-48**



Meets SAE 100R18

30CT Constant pressure **B-49**



Extreme pressure

3V10 Very high pressure **B-50**

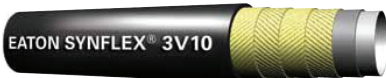

3VE0 Very high pressure, non-conductive **B-51**



3130, 37AL and 30CT Twin-line, tri-line, multi-line **B-52**

GH681 (Premium)

MatchMate® Global 3000 PSI constant pressure

Meets or exceeds: SAE 100R1 Type S, EN853 Type 1SN, ISO 18752, ISO 1436-1 Type 1SN performance (-3 thru -8) for pressure, but does not meet dimensional requirements.

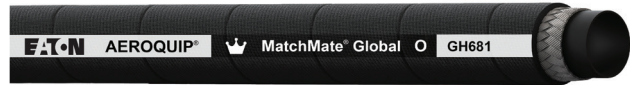

Triple crown

- Pressure
- Temperature
- Abrasion resistance

# Part number	Hose I.D.			Nominal Hose O.D.		Maximum operating pressure		Minimum burst pressure		Minimum bend radius		Weight	
	DN	mm	in	mm	in	bar	psi	bar	psi	mm	in	kg/m	lbs/ft
GH681-3	5	4,8	0.19	10,9	0.42	250,0	3625	1000	14500	45,0	1.77	0,19	0.13
GH681-4	6	6,4	0.25	12,9	0.51	255,0	3700	1020	14800	50,0	1.97	0,21	0.14
GH681-5	8	7,9	0.31	14,0	0.55	225,0	3250	900	13000	55,0	2.17	0,22	0.15
GH681-6	10	9,5	0.38	16,3	0.64	235,0	3400	940	13600	63,0	2.48	0,31	0.21
GH681-8	12	12,7	0.50	19,9	0.78	221,0	3200	883	12800	90,0	3.54	0,43	0.29
GH681-10	16	15,9	0.63	22,3	0.88	140,0	2025	559	8100	100,0	3.94	0,42	0.28
GH681-12	19	19,0	0.75	26,0	1.02	138,0	2000	552	8000	120,0	4.72	0,56	0.37
GH681-16	25	25,4	1.00	34,0	1.34	103,0	1500	414	6000	150,0	5.91	0,80	0.54
GH681-20	31	31,8	1.25	41,5	1.63	69,0	1000	276	4000	210,0	8.27	1,01	0.68
GH681-24	38	38,1	1.50	47,9	1.89	52,0	750	207	3000	250,0	9.84	1,19	0.80
GH681-32	51	50,8	2.00	64,0	2.52	41,0	600	166	2400	315,0	12.4	1,92	1.29

Construction

Tube: Synthetic rubber

Reinforcement: Single wire braid

Cover: DURA-TUFF™ synthetic rubber

Operating parameters

-46°C to +120°C
(-51°F to +248°F)

Application

- Low and medium pressure hydraulic systems, petroleum and water-based fluids, construction equipment, and agriculture equipment

For more information on agency listings, specific fluid applications and high temperature ratings see section A.

MSHA Accepted

ABS Accepted

DNV Accepted

Fitting reference	Page
-------------------	------

Crimp

TTC	H-5-56
Skive nipple	H-5-56
Socket data	H-4

For reusable fittings please see our Aeroquip Reusable Fittings supplement A-HOAS-CC001-E on PowerSource.

Hydraulic hose

Braided hose – Premium

B

FC839B (Ultra abrasion)

BRUISER 3000 PSI constant pressure



Meets: SAE 100R17 performance, ISO 18752

# Part number	Hose I.D.			Nominal Hose O.D.		Maximum operating pressure		Minimum burst pressure		Minimum bend radius		Weight	
	DN	mm	in	mm	in	bar	psi	bar	psi	mm	in	kg/m	lbs/ft
FC839B-04	6	6,4	0.25	12,7	0.50	210	3,050	840	12,200	50,0	1.97	0,22	0.15
FC839B-06	10	9,7	0.38	16,6	0.65	210	3,050	840	12,200	65,0	2.56	0,34	0.23
FC839B-08	12	12,7	0.50	20,8	0.82	210	3,050	840	12,200	90,0	3.54	0,48	0.32
FC839B-10**	16	15,9	0.62	24,9	0.98	210	3,050	840	12,200	100,0	3.94	0,71	0.48
FC839B-12**	19	19,0	0.75	28,4	1.12	210	3,050	840	12,200	120,0	4.72	0,89	0.60
FC839B-16**	25	25,4	1.00	37,1	1.46	210	3,050	840	12,200	150,0	5.91	1,43	0.96

**Two braids of high tensile wire.

Construction

Tube: Synthetic rubber

Reinforcement: One or two layers of braided wire

Cover: Synthetic rubber intermediate cover and BRUISER™ outer cover

Operating parameters

-40°C to +100°C
(-40°F to +212°F)

Application

- High abrasion industrial and hydraulic system applications with petroleum and water-based fluids
- Recommended for use on critical applications in construction, forestry, and other off-highway vehicles. BRUISER™ outer cover offers unmatched abrasion, chemical, and environmental protection

For more information on agency listings, specific fluid applications and high temperature ratings see section A.

Fitting reference	Page
Crimp	
TTC	H-5-56
Skive nipple	H-5-56
Socket data	H-4

GH194 (Premium high temperature)

HI-IMPULSE MatchMate Global

Meets or exceeds: SAE 100R1AT Type S, EN 853 1SN, ISO 1436-1 Type 1SN performance



# Part number	Hose I.D.			Nominal Hose O.D.		Maximum operating pressure		Minimum burst pressure		Minimum bend radius		Weight	
	DN	mm	in	mm	in	bar	psi	bar	psi	mm	in	kg/m	lbs/ft
GH194-4	6	6,4	0.25	13,5	0.53	225	3,250	900	13,000	100,0	3.94	0,25	0.17
GH194-6	10	9,5	0.38	17,3	0.68	215	3,125	860	12,500	125,0	4.92	0,37	0.25
GH194-8	12	12,7	0.50	20,4	0.80	175	2,550	700	10,200	180,0	7.09	0,45	0.30
GH194-10	16	15,9	0.62	23,8	0.94	140	2,050	560	8,200	205,0	8.07	0,54	0.36
GH194-12	19	19,0	0.75	27,4	1.08	125	1,800	500	7,200	240,0	9.45	0,69	0.46
GH194-16	25	25,4	1.00	36,2	1.42	90	1,300	360	5,200	300,0	11.81	0,98	0.66
GH194-20	31	31,8	1.25	43,9	1.73	65	950	260	3,800	420,0	16.54	1,26	0.85
GH194-24	38	38,1	1.50	50,6	1.99	50	725	200	2,900	500,0	19.69	1,58	1.06
GH194-32	51	50,8	2.00	64,0	2.52	40	580	160	2,320	630,0	24.80	2,04	1.37

Construction

Tube: AQP elastomer CPE

Reinforcement:

Single wire braid

Cover: Blue CPE

Operating parameters

-40°C to + 150°C
(-40°F to + 302°F)

Application

- Petroleum and fire-resistant hydraulic fluids, fuel and lubricating oils, gasoline, water and other industrial fluids

For more information on agency listings, specific fluid applications and high temperature ratings see section A.

MSHA Accepted

ABS Accepted

DNV Accepted

Fitting reference	Page
-------------------	------

Crimp	
-------	--

TTC	H-5-56
Skive nipple	H-5-56
Socket data	H-4

Hydraulic hose

Braided hose – Premium

B

GH781 (Premium) MatchMate Global

Exceeds: SAE 100R16 Type S, EN 857 2SC,
ISO 18752, ISO 11237-1 Type 2SC performance



Triple crown

- Pressure
- Temperature
- Abrasion resistance

# Part number	Hose I.D.			Nominal Hose O.D.		Maximum operating pressure		Minimum burst pressure		Minimum bend radius		Weight	
	DN	mm	in	mm	in	bar	psi	bar	psi	mm	in	kg/m	lbs/ft
GH781-4	6	6,4	0.25	13,9	0.55	448	6,500	1792	26000	50,0	1.96	0,33	0.22
GH781-6	10	9,5	0.38	17,4	0.69	400	5,800	1600	23200	65,0	2.55	0,43	0.29
GH781-8	12	12,7	0.50	20,9	0.82	345	5,000	1380	20000	90,0	3.54	0,58	0.39
GH781-10	16	15,9	0.62	24,0	0.94	276	4,000	1104	16000	100,0	3.94	0,65	0.44
GH781-12	19	19,0	0.75	27,9	1.10	241	3,500	964	14000	120,0	4.72	0,79	0.53
GH781-16	25	25,4	1.00	35,9	1.41	207	3,000	828	12000	150,0	5.90	1,07	0.72
GH781-20	31	31,8	1.25	43,4	1.71	172	2,500	688	10000	210,0	8.26	1,62	1.09
GH781-24	38	38,1	1.50	51,5	2.03	138	2,000	552	8000	250,0	9.84	2,08	1.40
GH781-32	51	50,8	2.00	63,9	2.52	110	1,600	440	6400	315,0	12.40	2,82	1.90

Construction

Tube: Synthetic rubber

Reinforcement: Double wire braid

Cover: DURA-TUFF™ synthetic rubber

Operating parameters

-46°C to +126°C
(-50°F to +260°F)

Application

- Low and medium pressure hydraulic systems, petroleum and water-based fluids, construction equipment, and agriculture equipment

For more information on agency listings, specific fluid applications and high temperature ratings see section A.

MSHA Accepted

ABS Accepted

DNV Accepted

Fitting reference	Page
Crimp	
TTC	H-5-56
Skive nipple *	H-5-56
Socket data	H-4

*.04 thru -20 only

For reusable fittings please see our Aeroquip Reusable Fittings supplement A-HOAS-CC001-E on PowerSource.

FC735 (Ultra abrasion)

BRUISER

Meets or exceeds: SAE 100R16 Type S, EN 857 2SC, ISO 18752, ISO 11237-1 Type 2SC performance



# Part number	Hose I.D.			Nominal Hose O.D.		Maximum operating pressure		Minimum burst pressure		Minimum bend radius		Weight	
	DN	mm	in	mm	in	bar	psi	bar	psi	mm	in	kg/m	lbs/ft
FC735-04*	6	6,4	0.25	14,1	0.55	448	5800*	1600,0	23200*	50,8	2.00	0,31	0.21
FC735-06	10	9,5	0.38	17,4	0.69	400	5300	1462,0	21200	63,5	2.50	0,42	0.28
FC735-08	12	12,7	0.50	20,8	0.82	345	4275	1180,0	17100	88,9	3.50	0,49	0.33
FC735-10	16	15,9	0.62	24,8	0.98	276	4000	1103,0	16000	101,6	4.00	0,71	0.48
FC735-12	19	19,1	0.75	28,4	1.12	241	3125	860,0	12500	120,7	4.75	0,83	0.56
FC735-16	25	25,4	1.00	35,7	1.41	207	2550	700,0	10200	152,4	6.00	1,19	0.80
FC735-20	31	31,8	1.25	43,3	1.70	172	2250	620,0	9000	209,6	8.25	1,52	1.02

*Meets SAE100R2 pressures.

Construction

Tube: Synthetic rubber

Reinforcement: Double wire braid

Cover: Synthetic rubber intermediate cover and BRUISER™ outer cover

Operating parameters

-40°C to +126°C
(-40°F to +260°F)

Application

- High abrasion applications
- Hydraulic system service with petroleum and water-based fluids
- For general industrial service

For more information on agency listings, specific fluid applications and high temperature ratings see section A.

Fitting reference	Page
Crimp	
TTC	H-5-56
Skive nipple	H-5-56
Socket data	H-4

Hydraulic hose

Braided hose – Premium

B

GH195 (Premium high temperature) HI-IMPULSE MatchMate Blue

Meets or exceeds: SAE 100R2 Type S, EN 853 2SN,
ISO 1436-1 Type 2SN performance



# Part number	Hose I.D.			Nominal Hose O.D.		Maximum operating pressure		Minimum burst pressure		Minimum bend radius		Weight	
	DN	mm	in	mm	in	bar	psi	bar	psi	mm	in	kg/m	lbs/ft
GH195-4	6	6,4	0.25	15,1	0.60	400,0	5800	1600,0	23200	102,0	4.02	0,40	0.27
GH195-6	10	9.5	0.38	19,2	0.75	345,0	5000	1380,0	20000	127,0	5.00	0,58	0.39
GH195-8	12	12,7	0.50	22,1	0.87	293,0	4250	1172,0	17000	178,0	7.01	0,68	0.46
GH195-10	16	15.9	0.62	25,5	1.00	250,0	3650	1000,0	14600	203,0	7.99	0,80	0.54
GH195-12	19	19,0	0.75	29,5	1.16	215,0	3125	860,0	12500	241,0	9.49	1,00	0.67
GH195-16	25	25,4	1.00	37,8	1.49	175,0	2550	700,0	10200	305,0	12.01	1,44	0.97
GH195-20	31	31,8	1.25	48,5	1.91	155,0	2250	620,0	9000	419,0	16.50	2,38	1.60
GH195-24	38	38,1	1.50	55,1	2.17	125,0	1800	500,0	7250	508,0	20.00	2,59	1.74
GH195-32	51	50,8	2.00	67,8	2.67	105,0	1525	420,0	6100	635,0	25.00	3,38	2.27

Construction

Tube: CPE

Reinforcement: 2 steel braids

Cover: Blue CPE

Operating parameters

-40°C to + 150°C
(-40°F to + 300°F)

Application

- Petroleum and fire resistant hydraulic fluids, fuel, and lubricating systems

MSHA Accepted

ABS Accepted

For more information on agency listings, specific fluid applications and high temperature ratings see section A.

Fitting reference	Page
Crimp	
TTC	H-5-56
Skive nipple	H-5-56
Socket data	H-4

GH120 (Premium low temperature)

MatchMate ICE

Meets or exceeds: SAE 100R16 Types, EN 857 Type 2SC, ISO 11237-1 Type 2SC performance



Triple crown

- Pressure
- Temperature
- Abrasion resistance

#	Hose I.D.			Nominal Hose O.D.		Maximum operating pressure		Minimum burst pressure		Minimum bend radius		Weight		
	Part number	DN	mm	in	mm	in	bar	psi	bar	psi	mm	in	kg/m	lbs/ft
	GH120-4	6	6,4	0.25	13,8	0.54	414,0	6000	1656,0	24025	51,0	2.00	0,30	0.20
	GH120-6	10	9,5	0.38	17,4	0.68	345,0	5000	1380,0	20025	64,0	2.50	0,40	0.27
	GH120-8	12	12,7	0.50	20,8	0.82	310,0	4500	1240,0	18000	89,0	3.50	0,58	0.39
	GH120-10	16	15,9	0.62	24,9	0.98	276,0	4000	1104,0	16000	102,0	4.00	0,74	0.50
	GH120-12	19	19,0	0.75	28,4	1.12	241,0	3500	964,0	14000	121,0	4.75	0,92	0.62
	GH120-16	25	25,4	1.00	35,7	1.41	193,0	2800	772,0	11200	152,0	6.00	1,22	0.82
	GH120-20	31	31,8	1.25	43,3	1.71	159,0	2300	636,0	9225	210,0	8.25	1,59	1.07
	GH120-24	38	38,1	1.50	51,5	2.03	138,0	2000	552,0	8000	254,0	10.00	2,11	1.42
	GH120-32	51	50,8	2.00	63,9	2.51	103,0	1500	412,0	6000	318,0	12.50	2,80	1.88

Construction

Tube: Special low-temperature synthetic rubber

Reinforcement: Double wire braid

Cover: DURA-TUFF™ synthetic rubber

Operating parameters

-57°C to +100°C
(-70°F to +212°F)

Application

- Low temperature flexing and hydraulic system service with petroleum and water-based fluids
- For use in frigid environments on construction equipment and other mobile applications

For more information on agency listings, specific fluid applications and high temperature ratings see section A.

MSHA Accepted

Fitting reference	Page
Crimp	
TTC	H-5-56
Skive nipple *	H-5-56
Socket data	H-4

*-04 thru -20 only

Hydraulic hose

Spiral hose – Premium

B

GH493 (Premium) MatchMate Global 1/2 SAE bend radius



Meets or exceeds: SAE 100R12, EN 856 Type R12, ISO 18752, ISO 3862 Type R12, EN 856 4SP performance (-8 thru -16)



Triple crown

- Pressure
- Temperature
- Abrasion resistance

# Part number	Hose I.D.			Nominal Hose O.D.		Maximum operating pressure		Minimum burst pressure		Minimum bend radius		Weight	
	DN	mm	in	mm	in	bar	psi	bar	psi	mm	in	kg/m	lbs/ft
GH493-6	10	9,5	0.38	20,2	0.80	448,0	6500	1792,0	26000	62,5	2.46	0,71	0.48
GH493-8	12	12,7	0.50	23,6	0.93	415,0	6000	1660,0	24000	90,0	3.54	0,87	0.59
GH493-10	16	15,9	0.62	27,4	1.08	415,0	6000	1660,0	24000	100,0	3.94	1,00	0.68
GH493-12	19	19,0	0.75	30,7	1.21	380,0	5500	1520,0	22000	120,0	4.72	1,34	0.90
GH493-16	25	25,4	1.00	37,9	1.49	350,0	5100	1400,0	20400	150,0	5.91	1,78	1.20
GH493-20	31	31,8	1.25	46,6	1.84	310,0	4500	1240,0	18000	210,0	8.27	2,41	1.62
GH493-24	38	38,1	1.50	53,9	2.12	275,0	4000	1100,0	16000	250,0	9.84	3,00	2.01
GH493-32	51	50,8	2.00	66,8	2.63	275,0	4000	1100,0	16000	320,0	12.60	4,37	2.94

Construction

Tube: Synthetic rubber

Reinforcement: 4-spiral wire

Cover: DURA-TUFF™ synthetic rubber

Operating parameters

-40°C to +126°C
(-40°F to +260°F)

Application

- For very high pressure hydraulic lines subjected to pressure surges and flexing
- Typical applications include construction, mining, farming and high performance industrial equipment

For more information on agency listings, specific fluid applications and high temperature ratings see section A.

MSHA Accepted

ABS Accepted

Fitting reference	Page
Crimp	
4S	H-57-77
TTC12	H-5-56
Reusable	
Spiral hose	I-41-47
Socket data	I-3

FC736 (Ultra abrasion)

BRUISER 4S

Meets or exceeds: SAE 100R12, ISO 18752, EN 856 Type R12 performance



# Part number	Hose I.D.			Nominal Hose O.D.		Maximum operating pressure		Minimum burst pressure		Minimum bend radius		Weight	
	DN	mm	in	mm	in	bar	psi	bar	psi	mm	in	kg/m	lbs/ft
FC 736-06	10	9,5	0.38	20,2	0.80	380	5500	1520	22000	125	4.92	0,71	0.48
FC736-08	12	12,7	0.50	23,6	0.93	345	5000	1380	20000	180	7.09	0,83	0.56
FC736-10	16	15,9	0.62	27,4	1.08	345	5000	1380	20000	200	7.87	0,98	0.66
FC736-12	19	19,0	0.75	30,7	1.21	280	4050	1120	16200	240	9.45	1,32	0.89
FC736-16	25	25,4	1.00	37,9	1.49	280	4050	1120	16200	300	11.81	1,75	1.18
FC736-20	31	31,8	1.25	46,6	1.84	210	3050	840	12200	420	16.54	2,36	1.59
FC736-24	38	38,1	1.50	53,9	2.12	175	2550	700	10200	500	19.68	3,00	2.01
FC736-32	51	50,8	2.00	66,8	2.63	175	2550	700	10200	640	25.2	4,37	2.94

Construction

Tube: Synthetic rubber
Reinforcement: 4-spiral wire
Cover: Synthetic rubber intermediate cover and BRUISER™ outer cover

Operating parameters

-40°C to +121°C
 (-40°F to +250°F)

Application

- High abrasion industrial and hydraulic system applications with petroleum and water-based fluids
- Recommended for critical applications in construction, forestry, and other off-highway vehicles
- BRUISER™ outer cover offers unmatched abrasion, chemical and environmental protection

For more information on agency listings, specific fluid applications and high temperature ratings see section A.

Fitting reference	Page
Crimp	
4S	H-57-77
TTC12	H-5-56
Reusable	
Spiral hose	I-41-47
Socket data	I-3

Hydraulic hose

Spiral hose – Premium

B

EC525 (Premium high temperature)

Hi-Temp Spiral

Exceeds: SAE 100R12, EN 856 Type R12 performance

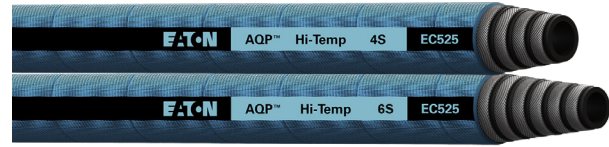

# Part number	Hose I.D.			Nominal Hose O.D.		Maximum operating pressure		Minimum burst pressure		Minimum bend radius		Weight	
	DN	mm	in	mm	in	bar	psi	bar	psi	mm	in	kg/m	lbs/ft
EC525-12	19	19,0	0.75	30,7	1.21	345,0	5000	1380,0	20000	241,3	9.50	1,28	0.86
EC525-16	25	25,4	1.00	37,9	1.49	345,0	5000	1380,0	20000	304,8	12.00	1,73	1.16
EC525-20	31	31,8	1.25	46,6	1.84	240,0	3500	960,0	14000	419,1	16.50	2,31	1.55
EC525-24	38	38,1	1.50	53,9	2.12	240,0	3500	960,0	14000	508,0	20.00	2,96	1.99
EC525-32	51	50,8	2.00	67,3	2.65	225,0	3250	900,0	13000	635,0	25.00	4,42	2.97

Construction

Tube: AQP elastomer

Reinforcement:

4-spiral wire in -12 to -24

6-spiral wire in -32

Cover: CPE high temperature

Operating parameters

-40°C to +149°C
(-40°F to +300°F)

-40°C to +82°C
(-40°F to +180°F)
for phosphate-ester
base fluids

Application

- Hydraulic system service with petroleum, fire-resistant, and water-based fluids, fuel, and lubricating systems

For more information on agency listings, specific fluid applications and high temperature ratings see section A.

MSHA Accepted

Fitting reference	Page
Crimp	
4S	H-57-77
6S	H-57-77
TTC12	H-5-56

FC500 (Premium) X-FLEX Spiral 1/2 SAE bend radius



Meets or exceeds: SAE 100R13, EN 856 Type R13, ISO 18752, ISO 3862 Type R13 performance

# Part number	Hose I.D.			Nominal Hose O.D.		Maximum operating pressure		Minimum burst pressure		Minimum bend radius		Weight	
	DN	mm	in	mm	in	bar	psi	bar	psi	mm	in	kg/m	lbs/ft
FC500-12	19	19,0	0.75	31,0	1.22	350,0	5100	1400,0	20400	121,0	4.75	1,28	0.86
FC500-16	25	25,4	1.00	38,4	1.51	350,0	5100	1400,0	20400	152,0	6.00	1,85	1.24
FC500-20	31	31,8	1.25	45,5	1.79	350,0	5100	1400,0	20400	210,0	8.25	2,50	1.68
FC500-24	38	38,1	1.50	53,5	2.11	350,0	5100	1400,0	20400	254,0	10.00	3,38	2.27
FC500-32	51	50,8	2.00	71,8	2.83	350,0	5100	1400,0	20400	476,0	18.75	6,07	4.08

Construction

Tube: Synthetic rubber

Reinforcement:

4-spiral wire in -12 to -24
6-spiral wire in -32

Cover: DURA-TUFF™
synthetic rubber

Operating parameters

-40°C to +127°C
(-40°F to +260°F)

Application

- Hydraulic system service with petroleum and water-based fluids
- For low temperature applications

For more information on agency listings, specific fluid applications and high temperature ratings see section A.

MSHA Accepted

ABS Accepted

Fitting reference	Page
Crimp	
4S	H-57-77
6S	H-57-77

Hydraulic hose

Spiral hose – Premium

B

FC273B (Ultra abrasion) BRUISER Spiral



Meets or exceeds: SAE 100R13, EN 856 R13, ISO 18752, ISO 3862 Type R13 performance

# Part number	Hose I.D.			Nominal Hose O.D.		Maximum operating pressure		Minimum burst pressure		Minimum bend radius		Weight	
	DN	mm	in	mm	in	bar	psi	bar	psi	mm	in	kg/m	lbs/ft
FC273B-12	19	19,0	0.75	32,1	1.26	350,0	5100	1400,0	20400	241,0	9.50	1,55	1.04
FC273B-16	25	25,4	1.00	38,7	1.53	350,0	5100	1400,0	20400	305,0	12.00	1,95	1.31
FC273B-20	31	31,8	1.25	50,3	1.98	350,0	5100	1400,0	20400	419,0	16.50	3,63	2.44
FC273B-24	38	38,1	1.50	57,7	2.27	350,0	5100	1400,0	20400	508,0	20.00	4,78	3.21
FC273B-32	51	50,8	2.00	71,8	2.83	350,0	5100	1400,0	20400	635,0	25.00	7,05	4.74

Construction

Tube: Synthetic rubber

Reinforcement:

4-spiral wire in -12, -16
6-spiral wire in -20, -24, -32

Cover: Synthetic rubber
intermediate cover and
BRUISER outer cover

Operating parameters

-40°C to +121°C
(-40°F to +250°F)

Application

- High abrasion industrial and hydraulic system applications with petroleum and water-based fluids
- Recommended for use on critical applications in construction, forestry, and other off-highway vehicles
- BRUISER outer cover offers unmatched abrasion, chemical and environmental protection

For more information on agency listings, specific fluid applications and high temperature ratings see section A.

Fitting reference	Page
Crimp	
4S (-12 thru -16)	H-57-77
6S (-20 thru -32)	H-57-77

EC810 (Premium low temperature) ICE CHAMPION Spiral

Exceeds: SAE 100R15, EN 856 Type R15 performance

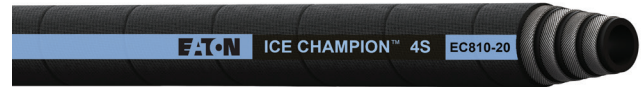

# Part number	Hose I.D.			Nominal Hose O.D.		Maximum operating pressure		Minimum burst pressure		Minimum bend radius		Weight	
	DN	mm	in	mm	in	bar	psi	bar	psi	mm	in	kg/m	lbs/ft
EC810-12	19	19,0	0.75	32,2	1.27	420	6100	1,680	24,360	280,0	11.02	1,61	1.08
EC810-16	25	25,4	1.00	39,0	1.54	420	6100	1,680	24,360	340,0	13.39	2,02	1.36
EC810-20	31	31,8	1.25	49,4	1.95	420	6100	1,680	24,360	420,0	16.54	3,55	2.39
EC810-24	38	38,1	1.50	57,3	2.26	420	6100	1,680	24,360	510,0	20.08	4,74	3.19
EC810-32	51	50,8	2.00	71,1	2.80	350	5100	1,400	20,305	630,0	24.80	6,70	4.50

Construction

Tube: Synthetic rubber

Reinforcement: Heavy
4-spiral wire in -12 to -16
6-spiral wire in -20 to -32

Cover: Synthetic rubber

Operating parameters

-57°C to +100°C
(-70°F to +212°F)

Application

- Fluids for low temperature applications
- Hydraulic systems with petroleum-based fluids

For more information on agency listings, specific fluid applications and high temperature ratings see section A.

MSHA Accepted

Fitting reference	Page
Crimp	
4S (-12 thru -16)	H-57-77
6S (-20 thru -32)	H-57-77

Contact Eaton for approved Internal Skive fittings (1W series)

Hydraulic hose

Spiral hose – Premium

B

EC600 (Premium) X-FLEX Spiral 1/2 SAE bend radius

Exceeds: SAE 100R15, ISO 18752 performance



# Part number	Hose I.D.			Nominal Hose O.D.		Maximum operating pressure		Minimum burst pressure		Minimum bend radius		Weight	
	DN	mm	in	mm	in	bar	psi	bar	psi	mm	in	kg/m	lbs/ft
EC600-12	19	19,0	0.75	32,3	1.27	420	6100	1680	24400	135,0	5.31	1,52	1.01
EC600-16	25	25,4	1.00	38,6	1.52	420	6100	1680	24400	165,0	6.50	2,04	1.36
EC600-20	31	31,8	1.25	49,8	1.96	420	6100	1680	24400	225,0	8.86	3,89	2.61
EC600-24	38	38,1	1.50	57,4	2.26	420	6100	1680	24400	265,0	10.43	4,83	3.24
*EC600-32	50	50,8	2.00	70,9	2.79	420	6100	1680	24400	375,0	14.76	7,10	4.77

*With the 6S fitting the -32 size working pressure is 380 bar (5500 psi) with a 4:1 safety factor

Construction

Tube: Synthetic rubber

Reinforcement:

4-spiral wire -12, -16
6-spiral wire -20, -24, -32

Cover: DURA-TUFF™
synthetic rubber

Operating parameters

-40°C to +121°C
(-40°F to +250°F)

Application

- High-pressure hydraulics, hydrostatic transmissions
- Hydraulic system with petroleum and water-glycol base fluids, for lubricants oils and water

For more information on agency listings, specific fluid applications and high temperature ratings see section A.

MSHA Accepted
DNV
ABS
U.S. Coast Guard

Fitting reference	Page
Crimp	
4S (-12 thru -16)	H-57-77
6S (-20 thru -32)	H-57-77

Contact Eaton for approved Internal Skive fittings (1W series)

EC850 DYNAMAX Spiral

Exceeds: SAE 100R15, ISO 18752



# Part number	Hose I.D.			Nominal Hose O.D.		Maximum operating pressure		Minimum burst pressure		Minimum bend radius		Weight	
	DN	mm	in	mm	in	bar	psi	bar	psi	mm	in	kg/m	lbs/ft
EC850-10	16	15,9	0.63	27,4	1.08	500	7250	2000	29000	200,0	7.87	1,23	0.82
EC850-12	19	19,1	0.75	31,5	1.24	500	7250	2000	29000	215,0	8.46	1,52	1.01
EC850-16	25	25,4	1.00	39,4	1.55	500	7250	2000	29000	270,0	10.63	2,31	1.54
EC850-20	31	31,8	1.25	49,5	1.95	500	7250	2000	29000	380,0	14.96	4,01	2.69

Construction

Tube: Synthetic rubber

Reinforcement:

4-spiral wire in -10, -12, -16
6-spiral wire in -20

Cover: Black highly abrasion
resistant DURA-TUFF
synthetic rubber

Operating parameters

-40°C to +100°C
(-40°F to +212°F)

Application

- Ultra high pressure
- Hydraulic systems with petroleum and water-glycol based fluids
- Lubricating oils and water

For more information on agency listings, specific fluid applications and high temperature ratings see section A.

MSHA Accepted

Fitting reference*

Contact Eaton for approved Internal Skive fittings (1W series)

* Refer to Eaton bulletin
E-HOSP-MS001-E1

Hydraulic hose

Braided hose – Other

B

FC639

MatchMate Global 3000 PSI constant pressure



Meets: SAE 100R17

# Part number	Hose I.D.			Nominal Hose O.D.		Maximum operating pressure		Minimum burst pressure		Minimum bend radius		Weight	
	DN	mm	in	mm	in	bar	psi	bar	psi	mm	in	kg/m	lbs/ft
FC639-04	6	6,4	0.25	12,7	0.50	210,0	3000	840,0	12000	50,8	2.00	0,22	0.15
FC639-06	10	9,7	0.38	16,5	0.65	210,0	3000	840,0	12000	63,5	2.50	0,34	0.23
FC639-08	12	12,7	0.50	20,8	0.82	210,0	3000	840,0	12000	88,9	3.50	0,48	0.32
FC639-10*	16	16,0	0.63	24,9	0.98	210,0	3000	840,0	12000	101,6	4.00	0,76	0.51
FC639-12*	19	19,1	0.75	28,4	1.12	210,0	3000	840,0	12000	120,7	4.75	0,94	0.63
FC639-16*	25	25,4	1.00	37,1	1.46	210,0	3000	840,0	12000	152,4	6.00	1,24	0.83

*Double wire braids of high tensile wire.

Construction

Tube: Synthetic rubber

Reinforcements: Single or double-wire braid

Cover: Ozone flexible neoprene rubber

Operating parameters

-40°C to +100°C
(-40°F to +212°F)

Application

- General industrial and hydraulic system service with petroleum and water-based fluids.
- Recommended for high-pressure oil lines used on construction equipment and other off-highway applications

For more information on agency listings, specific fluid applications and high temperature ratings see section A.

Fitting reference	Page
Crimp	
TTC	H-5-56
Skive nipple	H-5-56
Socket data	H-4

GH663

MatchMate Global 1/2 SAE bend radius

Meets or exceeds: SAE 100R1 Type S, EN 853 1SN, ISO 1436-1 Type 1SN, DIN 20 022 Type 1SN

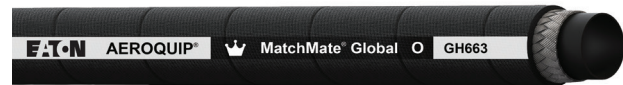

Triple crown

- Pressure
- Temperature
- Abrasion resistance

# Part number	Hose I.D.			Nominal Hose O.D.		Maximum operating pressure		Minimum burst pressure		Minimum bend radius		Weight	
	DN	mm	in	mm	in	bar	psi	bar	psi	mm	in	kg/m	lbs/ft
GH663-4	6	6,4	0.25	13,5	0.53	255,0 192,0	3700† 2750	1020,0 770,0	14800† 11000	51,0	2.00	0,24	0.16
GH663-6	10	9,7	0.38	17,5	0.69	235,0 157,0	3400† 2250	940,0 630,0	13600† 9000	62,5	2.50	0,37	0.25
GH663-8	12	12,7	0.50	20,6	0.81	200,0 140,0	2900† 2000	800,0 560,0	11600† 8000	90,0	3.50	0,45	0.30
GH663-12	19	19,1	0.75	27,8	1.09	138,0 87,0	2000† 1250	552,0 350,0	8000† 5000	120,0	4.75	0,67	0.45
GH663-16	25	25,4	1.00	35,8	1.41	103,0 70,0	1500† 1000	412,0 280,0	6000† 4000	150,0	6.00	1,01	0.68
GH663-20	31	31,8	1.25	43,4	1.71	69,0	1000	276,0	4000	210,0	8.25	1,31	0.88
GH663-24	38	38,1	1.50	50,6	1.99	52,0	750	208,0	3000	250,0	10.00	1,56	1.05
GH663-32	51	50,8	2.00	64,0	2.52	41,0	600	164,0	2400	315,0	12.50	1,95	1.31

† Improved performance when used with Global Crimp fittings.

Construction

Tube: Synthetic rubber

Reinforcement: Single wire braid

Cover: DURA-TUFF synthetic rubber

Operating parameters

-46°C to +127°C
(-50°F to +260°F)

Application

- Hydraulic system service with petroleum and water-based fluids, for general industrial service

For more information on agency listings, specific fluid applications and high temperature ratings see section A.

Fitting reference	Page
Crimp	
TTC	H-5-56
Skive nipple	H-5-56
Socket data	H-4
Reusable	
SAE 100R5 style Fitting	I-4-16
Socket data	I-3

Hydraulic hose

Braided hose – Other

B

FC849

4000 PSI constant pressure

Meets or exceeds: SAE 100R19



# Part number	Hose I.D.			Nominal Hose O.D.		Maximum operating pressure		Minimum burst pressure		Minimum bend radius		Weight	
	DN	mm	in	mm	in	bar	psi	bar	psi	mm	in	kg/m	lbs/ft
FC849-04	6	6,4	0.25	15,2	0.60	280,0	4000	1120,0	16000	50,8	2.00	0,36	0.24
FC849-06	10	9,7	0.38	19,3	0.76	280,0	4000	1120,0	16000	63,5	2.50	0,54	0.36
FC849-08	12	12,7	0.50	22,6	0.89	280,0	4000	1120,0	16000	88,9	3.50	0,64	0.43
FC849-10	16	16,0	0.63	25,7	1.01	280,0	4000	1120,0	16000	101,6	4.00	0,90	0.60
FC849-12	19	19,1	0.75	30,0	1.18	280,0	4000	1120,0	16000	120,7	4.75	1,07	0.72

Construction

Tube: Synthetic rubber

Reinforcement: Double-wire braid

Cover: Synthetic rubber

Operating parameters

-40°C to +100°C
(-40°F to +212°F)

Application

- Industrial and hydraulic system applications with petroleum and water-based fluids
- Recommended for use on construction, forestry, and other off-highway vehicles

For more information on agency listings, specific fluid applications and high temperature ratings see section A.

Fitting reference	Page
Crimp	
TTC	H-5-56
Skive nipple (-06 thru -12)	H-5-56
Socket data	H-4

FC849B (Ultra abrasion) BRUISER 4000 PSI constant pressure



Meets or exceeds: SAE 100R19

# Part number	Hose I.D.			Nominal Hose O.D.		Maximum operating pressure		Minimum burst pressure		Minimum bend radius		Weight	
	DN	mm	in	mm	in	bar	psi	bar	psi	mm	in	kg/m	lbs/ft
FC849B-04	6	6,4	0.25	15,2	0.60	280,0	4000	1120,0	16000	50,8	2.00	0,36	0.24
FC849B-06	10	9,7	0.38	19,3	0.76	280,0	4000	1120,0	16000	63,5	2.50	0,54	0.36
FC849B-08	12	12,7	0.50	22,6	0.89	280,0	4000	1120,0	16000	88,9	3.50	0,64	0.43
FC849B-10	16	16,0	0.63	25,7	1.01	280,0	4000	1120,0	16000	101,6	4.00	0,90	0.60
FC849B-12	19	19,1	0.75	30,0	1.18	280,0	4000	1120,0	16000	120,7	4.75	1,07	0.72

Construction

Tube: Synthetic rubber

Reinforcement: Double-wire braid

Cover: Synthetic rubber intermediate cover and BRUISER outer

Operating parameters

-40°C to +100°C
(-40°F to +212°F)

Application

- High abrasion industrial and hydraulic system applications with petroleum and water-based fluids
- Recommended for use on critical applications in construction, forestry, and other off-highway vehicles

For more information on agency listings, specific fluid applications and high temperature ratings see section A.

Fitting reference	Page
Crimp	
TTC	H-5-56
Skive nipple (-06 thru -12)	H-5-56
Socket data	H-4

Hydraulic hose

Braided hose – Other

B

FC310

HI-PAC wire braid

Meets: EN 857 Type 1SC



# Part number	Hose I.D.			Nominal Hose O.D.		Maximum operating pressure		Minimum burst pressure		Minimum bend radius		Weight	
	DN	mm	in	mm	in	bar	psi	bar	psi	mm	in	kg/m	lbs/ft
FC310-04	6	6,4	0.25	14,0	0.55	350,0	5000	1400,0	20000	50,8 76,2	2.00† 3.00	0,31	0.21
FC310-06	10	9,7	0.38	17,3	0.68	280,0	4000	1120,0	16000	63,5 88,9	2.50† 3.50	0,40	0.27
FC310-08	12	12,7	0.50	20,1	0.79	245,0	3500	980,0	14000	88,9 127,0	3.50† 5.00	0,51	0.34
FC310-10	16	16,0	0.63	23,6	0.93	192,0	2750	770,0	11000	101,6 152,4	4.00† 6.00	0,65	0.44
FC310-12	19	19,1	0.75	27,4	1.08	157,0	2250	630,0	9000	120,7 177,8	4.75† 7.00	0,74	0.50
FC310-16	25	25,4	1.00	34,6	1.36	140,0	2000	560,0	8000	152,4 228,6	6.00† 9.00	1,06	0.71
FC310-20	31	31,8	1.25	42,9	1.69	113,0	1625	455,0	6500	209,6 279,4	8.25† 11.00	1,58	1.06

† Improved minimum bend radius when used with global fittings.

Construction

Tube: Synthetic rubber
Reinforcement: HI-PAC braided wire
Cover: Synthetic rubber

Operating parameters

-40°C to +100°C
 (-40°F to +212°F)

Application

- Hydraulic system service with petroleum and water-based fluids, for general industrial service

For more information on agency listings, specific fluid applications and high temperature ratings see section A.

Fitting reference	Page
Crimp	
TTC	H-5-56
Skive nipple	H-5-56
Socket data	H-4
Reusable	
Hi-Pac	I-20
Socket data	I-3

FC510

HI-PAC wire braid, high temperature

Meets: SAE 100R2, EN857 Type 1SC



# Part number	Hose I.D.			Nominal Hose O.D.		Maximum operating pressure		Minimum burst pressure		Minimum bend radius		Weight	
	DN	mm	in	mm	in	bar	psi	bar	psi	mm	in	kg/m	lbs/ft
FC510-04	6	6,4	0.25	14,5	0.57	350,0	5000	1400,0	20000	76,2	3.00	0,34	0.23
FC510-06	10	9,7	0.38	17,5	0.69	280,0	4000	1120,0	16000	88,9	3.50	0,43	0.29
FC510-08	12	12,7	0.50	20,3	0.80	245,0	3500	980,0	14000	127,0	5.00	0,51	0.34
FC510-10	16	16,0	0.63	23,6	0.93	192,0	2750	770,0	11000	152,4	6.00	0,65	0.44
FC510-12	19	19,1	0.75	27,7	1.09	157,0	2250	630,0	9000	177,8	7.00	0,77	0.52
FC510-16	25	25,4	1.00	34,8	1.37	140,0	2000	560,0	8000	228,6	9.00	1,06	0.71
FC510-20	31	31,8	1.25	43,2	1.70	113,0	1625	455,0	6500	279,4	11.00	1,61	1.08

Construction

Tube: AQP elastomer

Reinforcement: HI-PAC braided wire

Cover: Blue AQP elastomer cover

Operating parameters

-40°C to +150°C
(-40°F to +302°F)

Application

- Petroleum and fire-resistant hydraulic fluids, fuel, and lubricating systems

For more information on agency listings, specific fluid applications and high temperature ratings see section A.

Fitting reference	Page
Crimp	
TTC	H-5-56
Skive nipple	H-5-56
Socket data	H-4
Reusable	
Hi-Pac	I-20
Socket data	I-3

Hydraulic hose

Braided hose – Other

B

GH793

MatchMate Global

Meets: SAE 100R2 Type S, EN 853 (Type 2SN),
DIN 2022, Teil 4 (Type 2SN)



Triple crown

- Pressure
- Temperature
- Abrasion resistance

#	Hose I.D.			Nominal Hose O.D.		Maximum operating pressure		Minimum burst pressure		Minimum bend radius		Weight	
	Part number	DN	mm	in	mm	in	bar	psi	bar	psi	mm	in	kg/m
GH793-4	6	6,4	0.25	15,2	0.60	448,0 350,0	6500† 5000	1792,0 1400,0	26000† 20000	101,6	4.00	0,39	0.26
GH793-6	10	9,7	0.38	19,1	0.75	400,0 280,0	5800† 4000	1600,0 1120,0	23200† 16000	127,0	5.00	0,57	0.38
GH793-8	12	12,7	0.50	22,1	0.87	345,0 245,0	5000† 3500	1380,0 980,0	20000† 14000	177,8	7.00	0,68	0.46
GH793-10	16	16,0	0.63	24,9	0.98	276,0 192,0	4000† 2750	1104,0 770,0	16000† 11000	203,2	8.00	0,80	0.54
GH793-12	19	19,1	0.75	29,5	1.16	241,0 157,0	3500† 2250	964,0 630,0	14000† 9000	241,3	9.50	0,98	0.66
GH793-16	25	25,4	1.00	38,1	1.50	207,0 140,0	3000† 2000	828,0 560,0	12000† 8000	304,8	12.00	1,50	1.01
GH793-20	31	31,8	1.25	48,8	1.92	172,0	2500	688,0	10000	419,1	16.50	2,29	1.54
GH793-24	38	38,1	1.50	54,6	2.15	138,0	2000	552,0	8000	508,0	20.00	2,50	1.68
GH793-32	51	50,8	2.00	63,8	2.51	110,0	1600	440,0	6400	635,0	25.00	3,30	2.22

† Improved pressure performance when used with global crimp fittings.

Construction

Tube: Special low temperature synthetic rubber

Reinforcement: Double wire braid

Cover: DURA-TUFF synthetic rubber

Operating parameters

-40°C to +127°C
(-40°F to +260°F)

Application

- Hydraulic system service with petroleum and water-based fluids, for general industrial service

For more information on agency listings, specific fluid applications and high temperature ratings see section A.

Fitting reference	Page
Crimp	
TTC	H-5-56
Skive nipple	H-5-56
Socket data	H-4
Reusable	
Hi-Pac	I-20
Socket data	I-3

2681

HI-IMPULSE

Meets: SAE 100R1 Type A, EN853 Type 1ST, ISO 1436 Type 1ST

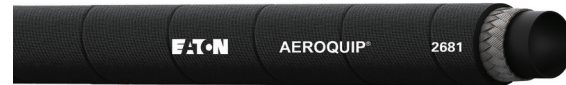

# Part number	Hose I.D.			Nominal Hose O.D.		Maximum operating pressure		Minimum burst pressure		Minimum bend radius		Weight	
	DN	mm	in	mm	in	bar	psi	bar	psi	mm	in	kg/m	lbs/ft
2681-3	5	4,8	0.19	12,7	0.50	280,0	4000	1120,0	16000	88,9	3.50	0,19	0.13
2681-4	6	6,4	0.25	15,8	0.62	227,0	3250	897,0	13000	100,0	4.00	0,28	0.19
2681-5	8	7,9	0.31	17,5	0.69	227,0	3250	897,0	13000	115,0	4.50	0,40	0.27
2681-6	10	9,7	0.38	19,8	0.78	210,0	3000	840,0	12000	125,0	5.00	0,45	0.30
2681-8	12	12,7	0.50	23,1	0.91	175,0	2500	700,0	10000	180,0	7.00	0,58	0.39
2681-10	16	16,0	0.63	26,2	1.03	140,0	2000	560,0	8000	200,0	8.00	0,68	0.46
2681-12	19	19,1	0.75	30,2	1.19	124,0	1800	497,0	7200	240,0	9.50	0,79	0.53
2681-16	25	25,4	1.00	38,1	1.50	90,0	1300	359,0	5200	300,0	12.00	1,19	0.80
2681-20	31	31,8	1.25	46,0	1.81	60,0	900	248,0	3600	420,0	16.50	1,46	0.98
2681-24	38	38,1	1.50	52,3	2.06	49,0	700	193,0	2800	500,0	20.00	1,67	1.12
2681-32	51	50,8	2.00	65,5	2.58	42,0	600	168,0	2400	630,0	25.00	2,43	1.63

Construction

Tube: Synthetic rubber

Reinforcement: Single wire braid

Cover: Synthetic rubber

Operating parameters

-40°C to +100°C
(-40°F to +212°F)

Application

- Hydraulic system service with petroleum and water-based fluids, for general industrial service

For more information on agency listings, specific fluid applications and high temperature ratings see section A.

Fitting reference	Page
Crimp	
Skive nipple (-06 thru -12)	H-5-56
Socket data	H-4

Hydraulic hose

Braided hose – Other

B

2781

HI-IMPULSE

Meets or exceeds: SAE 100R2 Type A, EN853 Type 2ST, ISO 1436 Type 2ST



# Part number	Hose I.D.			Nominal Hose O.D.		Maximum operating pressure		Minimum burst pressure		Minimum bend radius		Weight	
	DN	mm	in	mm	in	bar	psi	bar	psi	mm	in	kg/m	lbs/ft
2781-4	6	6,4	0.25	17,5	0.69	400,0 345,0	5800† 5000	1600,0 1380,0	23200† 20000	101,6	4.00	0,50	0.33
2781-6	10	9,7	0.38	21,3	0.84	345,0 280,0	5000† 4000	1380,0 1120,0	20000† 16000	127,0	5.00	0,67	0.45
2781-8	12	12,7	0.50	24,6	0.97	295,0 241,0	4300† 3500	1180,0 964,0	17200† 14000	177,8	7.00	0,83	0.56
2781-10	16	16,0	0.63	27,7	1.09	250,0 190,0	3650† 2750	1000,0 760,0	14600† 11000	203,2	8.00	0,97	0.62
2781-12	19	19,1	0.75	31,8	1.25	215,0 155,0	3100† 2250	860,0 620,0	12400† 9000	241,3	9.50	1,19	0.80
2781-16	25	25,4	1.00	39,6	1.56	175,0 138,0	2550† 2000	700,0 552,0	10200† 8000	304,8	12.00	1,58	1.06
2781-20	31	31,8	1.25	50,8	2.00	155,0 112,0	2250† 1625	620,0 448,0	9000† 6500	419,1	16.50	2,57	1.73
2781-24	38	38,1	1.50	57,2	2.25	125,0 86,0	1800† 1250	500,0 344,0	7200† 5000	508,0	20.00	3,05	2.05
2781-32	51	50,8	2.00	69,9	2.75	90,0 78,0	1300† 1125	360,0 312,0	5200† 4500	635,0	25.00	4,02	2.70

†Improved pressure performance when used with global fittings.

Construction

Tube: Synthetic rubber
Reinforcement: Double wire braid
Cover: DURA-TUFF synthetic rubber

Operating parameters

-40°C to +100°C
 (-40°F to +212°F)

Application

- Hydraulic system service with petroleum and water-based fluids, for general industrial service

For more information on agency listings, specific fluid applications and high temperature ratings see section A.

Fitting reference	Page
Crimp	
Skive nipple	H-5-56
Socket data	H-4
Reusable	
100R2 skive style	I-26-37
Socket data	I-3

FC611 EPDM



B

# Part number	Hose I.D.			Nominal Hose O.D.		Maximum operating pressure		Minimum burst pressure		Minimum bend radius		Weight	
	DN	mm	in	mm	in	bar	psi	bar	psi	mm	in	kg/m	lbs/ft
FC611-12	19	19,1	0.75	27,9	1.10	87,0	1250	350,0	5000	241,3	9.50	0,64	0.43
FC611-16	25	25,4	1.00	35,8	1.41	70,0	1000	280,0	4000	304,8	12.00	0,89	0.60
FC611-20	31	31,8	1.25	43,4	1.71	43,0	625	175,0	2500	419,1	16.50	1,19	0.80
FC611-24	38	38,1	1.50	50,5	1.99	35,0	500	140,0	2000	508,0	20.00	1,52	1.02
FC611-32	51	50,8	2.00	64,0	2.52	26,0	375	105,0	1500	635,0	25.00	1,90	1.28

Construction

Tube: EPDM rubber

Reinforcement: Single wire braid

Cover: Green EPDM rubber

Operating parameters

-40°C to +75°C
(-40°F to +175°F)

Application

- Ground support equipment (GSE), industrial phosphate ester-based fluids, water glycol systems

For more information on agency listings, specific fluid applications and high temperature ratings see section A.

Fitting reference	Page
Crimp	
TTC	H-5-56
Socket data	H-4

Hydraulic hose

Braided hose – Other

B

FC693

EPDM

3000 PSI constant pressure



# Part number	Hose I.D.			Nominal Hose O.D.		Maximum operating pressure		Minimum burst pressure		Minimum bend radius		Weight	
	DN	mm	in	mm	in	bar	psi	bar	psi	mm	in	kg/m	lbs/ft
FC693-04	6	6,4	0.25	15,2	0.60	350,0	5000	1400,0	20000	101,6	4.00	0,37	0.25
FC693-06	10	9,7	0.38	19,1	0.75	280,0	4000	1120,0	16000	127,0	5.00	0,54	0.36
FC693-08	12	12,7	0.50	22,1	0.87	245,0	3500	980,0	14000	177,8	7.00	0,60	0.40

Construction

Tube: EPDM rubber

Reinforcement: Double wire braid

Cover: Green EPDM rubber

Operating parameters

-40°C to +75°C
(-40°F to +175°F)

Application

- Ground support equipment (GSE), industrial phosphate ester-based fluids, water glycol systems

For more information on agency listings, specific fluid applications and high temperature ratings see section A.

Fitting reference	Page
Crimp	
TTC	H-5-56
Socket data	H-4

EC502

LifeSense™

Meets: SAE 100R2 Type S, EN853 2SN

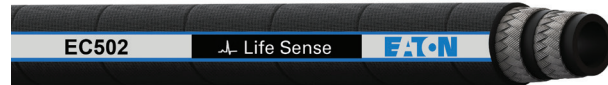

# Part number	Hose I.D.			Nominal Hose O.D.		Maximum operating pressure		Minimum burst pressure		Minimum bend radius		Weight	
	DN	mm	in	mm	in	bar	psi	bar	psi	mm	in	kg/m	lbs/ft
EC502-8	12	12,7	0.50	24,4	0.96	293	4,250	1172	17000	177,8	7.0	0,74	0.50
EC502-12	19	19,0	0.75	30,5	1.20	215	3,125	860	12500	241,3	9.5	0,98	0.66
EC502-16	24	25,4	1.00	38,6	1.50	172	2,500	690	10000	304,8	12.0	1,47	0.99

Construction

Tube: Synthetic rubber

Reinforcement:

Two-wire braid

Cover: Synthetic rubber

Operating parameters

-40°C to +100°C
(-40°F to +212°F)

Application

- General hydraulics
- Agricultural equipment – turf care
- Vocational fleets – mobile refuse, mobile cement mixers
- Manufacturing – stationary machining centers
- Safety barriers
- Laboratory test stands – dynamometers, impulse cycle machines

Features

- Diagnostic unit monitors hose condition in real time
- Detects failure-related events within a hose
- Provides advance notification the hose is approaching the end of its useful life

For more information on agency listings, specific fluid applications and high temperature ratings see section A.

Fitting reference

For fitting information, refer to LifeSense Installation Instructions, E-HOOV-TI001-E2

Hydraulic hose

Braided hose – Other

B

FC579

HI-IMPULSE Jack hose 10,000 PSI

Meets: IJ100



# Part number	Hose I.D.			Nominal Hose O.D.		Maximum operating pressure		Minimum burst pressure		Minimum bend radius		Weight	
	DN	mm	in	mm	in	bar	psi	bar	psi	mm	in	kg/m	lbs/ft
FC579-04	6	6,4	0.25	13,5	0.53	690,0	10000	1400,0	20000	50,8	2.00	0,33	0.22
FC579-06	10	9,7	0.38	17,5	0.69	690,0	10000	1400,0	20000	63,5	2.50	0,43	0.29

Construction

Tube: Synthetic rubber
Reinforcement: Double wire braid reinforcement
Cover: DURA-TUFF synthetic rubber

Operating parameters

-40°C to +100°C
 (-40°F to +212°F)

Application

- Hydraulic jacking system service with petroleum and water-based fluids
- Meets the performance requirements of the Material Handling Institute Specification IJ100

For more information on agency listings, specific fluid applications and high temperature ratings see section A.







Fitting reference	Page
Crimp	
TTC	H-5-56
Skive nipple	H-5-56
Socket data	H-4

EC230

Large bore

Meets: SAE 100R2 Type S



#													
	Part number	Hose I.D.			Nominal Hose O.D.		Maximum operating pressure		Minimum burst pressure		Minimum bend radius		Weight
	DN	mm	in	mm	in	bar	psi	bar	psi	mm	in	kg/m	lbs/ft
EC230-40	63	63,5	2.50	80,2	3.16	79,0	1150	316,0	4600	660,0	26.00	3,88	2.61

Construction

Tube: Synthetic rubber

Reinforcement: Double wire braid

Cover: DUA-TUFF synthetic rubber

Operating parameters

-40°C to +100°C
(-40°F to +212°F)

Application

- Hydraulic system service with petroleum and water-based fluids, for general industrial service

For more information on agency listings, specific fluid applications and high temperature ratings see section A.

Fitting reference

For fitting information, refer to Eaton bulletin E-HOBR-BB001-E.

Hydraulic hose

Spiral hose – Other

B

FC254

4S

Exceeds: EN 856 4SP



Triple crown

- Pressure
- Temperature
- Abrasion resistance

# Part number	Hose I.D.			Nominal Hose O.D.		Maximum operating pressure		Minimum burst pressure		Minimum bend radius		Weight	
	DN	mm	in	mm	in	bar	psi	bar	psi	mm	in	kg/m	lbs/ft
FC254-08	12	12,7	0.50	25,6	1.01	530,0	7700	2120	30800	203,0	8.0	1,07	0.72
FC254-12	19	19,0	0.75	32,5	1.28	497,0	7200	1988	28800	279,0	11.0	1,58	1.06
FC254-16	25	25,4	1.00	39,4	1.55	415,0	6000	1660	24000	305,0	12.0	1,96	1.32
FC254-20	31	31,8	1.25	46,0	1.81	350,0	5100	1400	20400	419,0	16.5	2,43	1.63
FC254-24	38	38,1	1.50	55,1	2.17	300,0	4350	1200	17400	508,0	20.0	3,02	2.03
FC254-32	51	50,8	2.00	69,3	2.73	275,0	4000	1100	16000	635,0	25.0	4,49	3.02

Construction

Tube: Synthetic rubber

Reinforcement: 4-spiral wire

Cover: DURA-TUFF
synthetic rubber

Operating parameters

-40°C to +127°C
(-40°F to +260°F)

Application

- Hydraulic system service with petroleum and water-based fluids
- For general industrial use

For more information on agency listings, specific fluid applications and high temperature ratings see section A.

MSHA Accepted

Fitting reference	Page
Crimp	
4S	H-57-77

GH506

4S

Meets: EN 856 Type 4SH, ISO 18752, ISO 3862 Type 4SH

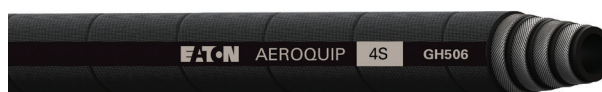

# Part number	Hose I.D.			Nominal Hose O.D.		Maximum operating pressure		Minimum burst pressure		Minimum bend radius		Weight	
	DN	mm	in	mm	in	bar	psi	bar	psi	mm	in	kg/m	lbs/ft
GH506-12*	19	19,0	0.75	33,0	1.30	420,0	6100	1680,0	24400	280,0	11.02	1,49	1.00
GH506-16*	25	25,4	1.00	39,4	1.54	380,0	5500	1520,0	22000	340,0	13.39	2,05	1.38
GH506-20	31	31,8	1.25	47,1	1.85	350,0	5100	1400,0	20400	460,0	18.11	2,54	1.71
GH506-24	38	38,1	1.50	53,6	2.11	300,0	4350	1200,0	17400	560,0	22.05	3,27	2.20
GH506-32	51	50,8	2.00	68,1	2.68	250,0	3650	1000,0	14600	700,0	27.56	4,58	3.08

* 2 million FLEX Impulse Cycles (use of Eaton approved "1W" internal skive fittings only).

Construction

Tube: Synthetic rubber

Reinforcement: 4-spiral wire

Cover: DURA-TUFF
synthetic rubber

Operating parameters

-40°C to +100°C
(-40°F to +212°F)

Application

- High pressure hydraulic systems with petroleum and water-based fluids

MSHA Accepted

For more information on agency listings, specific fluid applications and high temperature ratings see section A.

Fitting reference	Page
Crimp	
4S	H-57-77

*Internal Skive Fittings, contact Eaton for approved nipple and socket part numbers.

Hydraulic hose

Spiral hose – Other

B

FC606

6S

Meets or exceeds: SAE 100R15, ISO 3862 Type R15



# Part number	Hose I.D.			Nominal Hose O.D.		Maximum operating pressure		Minimum burst pressure		Minimum bend radius		Weight	
	DN	mm	in	mm	in	bar	psi	bar	psi	mm	in	kg/m	lbs/ft
FC606-16	25	25,4	1.00	42,9	1.69	420,0	6100	1680,0	24400	305,0	12.00	2,60	1.77
FC606-20	31	31,8	1.25	51,6	2.03	420,0	6100	1680,0	24400	419,0	16.50	3,60	2.42
FC606-24	38	38,1	1.50	58,4	2.30	420,0	6100	1680,0	24400	508,0	20.00	4,72	3.17

Construction

Tube: Synthetic rubber

Reinforcement: 6-spiral wire

Cover: DURA-TUFF
synthetic rubber

Operating parameters

-40°C to +121°C
(-40°F to +250°F)

Application

- High-pressure hydraulics, hydrostatic transmissions
- Hydraulic system service with petroleum and water-based fluids for general industrial use

For more information on agency listings, specific fluid applications and high temperature ratings see section A.

MSHA Accepted

Fitting reference	Page
Crimp	
6S	H-57-77

GH466 6S

Meets: EN 856 Type R13/R15, ISO 18752



# Part number	Hose I.D.			Nominal Hose O.D.		Maximum operating pressure		Minimum burst pressure		Minimum bend radius		Weight	
	DN	mm	in	mm	in	bar	psi	bar	psi	mm	in	kg/m	lbs/ft
GH466-20	31	31,8	1.25	50,4	1.98	420,0	6100	1680,0	24400	420,0	16.53	3,48	2.68
GH466-24	38	38,1	1.50	58,3	2.29	420,0	6100	1680,0	24400	510,0	19.69	4,63	3.56
GH466-32*	51	50,8	2.00	72,7	2.86	420,0	6100	1680,0	24400	630,0	24.80	6,70	5.16

Construction

Tube: Synthetic rubber

Reinforcement: High tensile
6-spiral wire layers

Cover: DURA-TUFF
synthetic rubber

Operating parameters

-40°C to +121°C
(-40°F to +250°F)

Application

- High pressure hydraulic systems with extreme pressure peaks. For use with petroleum and water-based fluids

For more information on agency listings, specific fluid applications and high temperature ratings see section A.

MSHA Accepted

Fitting reference	Page
Crimp	
6S (-20, -24)	H-57-77

*Internal Skive Fittings, contact Eaton technical support for information.

Hydraulic hose

Spiral hose – Other

B

FC636

EPDM Four spiral wire

Meets: SAE 100R12



# Part number	Hose I.D.			Nominal Hose O.D.		Maximum operating pressure		Minimum burst pressure		Minimum bend radius		Weight	
	DN	mm	in	mm	in	bar	psi	bar	psi	mm	in	kg/m	lbs/ft
FC636-12	19	19,0	0.75	31,5	1.24	275,0	4000	1100,0	16000	241,0	9.50	1,31	0.88
FC636-16	25	25,4	1.00	38,6	1.52	275,0	4000	1100,0	16000	305,0	12.00	1,74	1.17
FC636-20	31	31,8	1.25	47,5	1.87	207,0	3000	828,0	12000	419,0	16.50	2,31	1.55
FC636-24	38	38,1	1.50	54,9	2.16	172,0	2500	688,0	10000	508,0	20.00	2,92	1.96

Construction

Tube: EPDM rubber

Reinforcement: 4-spiral wire

Cover: Green EPDM rubber

Operating parameters

-40°C to +79°C
(-40°F to +174°F)

Application

- Ground support equipment (GSE), industrial phosphate ester based fluids, water glycol systems

For more information on agency listings, specific fluid applications and high temperature ratings see section A.

Fitting reference	Page
Crimp	
4S	H-57-77
TTC12	H-5-56

EC910

SAFESHIELD Waterblast

Meets: ISO 7751, EN1829-2 (impulse)



#	Hose I.D.			Nominal Hose O.D.		Maximum operating pressure		Minimum burst pressure		Minimum bend radius		Weight	
	Part number*	DN	mm	in	mm	in	bar	psi	bar	psi	mm	in	kg/m
EC910-08C50	12	12,7	0.50	24,6	0.97	1100,0	16000	2750,0	40000	228,6	9.00	1,12	0.75
EC910-12C50	19	19,0	0.75	32,8	1.29	1000,0	14500	2500,0	36250	279,4	11.00	1,74	1.17
EC910-16C50	25	25,4	1.00	39,9	1.57	690,0	10000	1725,0	25000	304,8	12.00	2,23	1.50

* 50 foot cut lengths (orders must be placed in 50 foot increments)

Construction

Tube: Synthetic rubber

Reinforcement: Heavy
4-spiral wire

Cover: DURA-TUFF
synthetic rubber cover
with color coded lay lines
in accordance with WJTA
(Water Jetting Technology
Association)

Operating parameters

-40°C to +93°C
(-40°F to +200°F)

Continuous service
temperature range
-10°C to +80°C
(-14°F to +176°F)

Application

- Waterblast service with
water, water-soap, emulsion

For more information on
agency listings, specific
fluid applications and high
temperature ratings see
section A.

Fitting reference**

Contact Eaton for approved Internal
skive fittings and sockets.

** Refer to Eaton bulletin
E-HOHP-MS003-E

Hydraulic hose

Suction hose – Specialty

B

FC619

Flexible 1/2 SAE bend radius

Exceeds: SAE 100R4, ISO 18752



# Part number	Hose I.D.			Nominal Hose O.D.		Maximum operating pressure		Minimum burst pressure		Minimum bend radius		Vacuum service		Weight	
	DN	mm	in	mm	in	bar	psi	bar	psi	mm	in	kPa	in/Hg	kg/m	lbs/ft
FC619-12	19	19,1	0.75	30,7	1.21	21,0	300 †	84,0	1200	63,5	2.50	94,8	28	0,68	0.46
FC619-16	25	25,4	1.00	37,6	1.48	17,0	250 †	70,0	1000	76,2	3.00	94,8	28	0,83	0.56
FC619-20	31	31,8	1.25	44,5	1.75	14,0	200 †	56,0	800	102,0	4.00	94,8	28	1,16	0.78
FC619-24	38	38,1	1.50	51,8	2.04	10,5	150 †	42,0	600	127,0	5.00	94,8	28	1,49	1.00
FC619-32	51	50,8	2.00	64,8	2.55	7,0	100 †	28,0	400	152,4	6.00	94,8	28	1,83	1.23
FC619-40	63	63,5	2.50	79,2	3.12	4,0	62	17,0	250	355,6	14.00	94,8	28	2,35	1.58
FC619-48	80	76,2	3.00	95,3	3.75	4,0	62	16,0	225	457,2	18.00	94,8	28	3,36	2.26

† Maximum working pressure for band clamp type fittings is 3,4 bar [50 psi].

Construction

Tube: Synthetic rubber

Reinforcement: Helical wire between two textile reinforcement layers

Cover: Synthetic rubber

Operating parameters

-40°C to +135°C
(-40°F to +275°F)

Application

- Suction and transfer applications for petroleum hydraulic fluids, fuel, lubricating oils, gasoline, water and many other industrial fluids

For more information on agency listings, specific fluid applications and high temperature ratings see section A.

Fitting reference	Page
Crimp	
TTC (-12 thru -32)	H-5-56
OTC	H-5-56
Skive nipple (-12 thru -20)	H-5-56
Socket data	H-4

2661

High temperature wire inserted suction

Exceeds: SAE 100R4



# Part number	Hose I.D.			Nominal Hose O.D.		Maximum operating pressure		Minimum burst pressure		Minimum bend radius		Vacuum service		Weight	
	DN	mm	in	mm	in	bar	psi	bar	psi	mm	in	kPa	in/Hg	kg/m	lbs/ft
2661-12	19	19,1	0.75	31,8	1.25	21,0	300 †	84,0	1200	125,0	5.0	94,8	28	0,62	0.42
2661-16	25	25,4	1.00	38,1	1.50	17,0	250 †	70,0	1000	150,0	6.0	94,8	28	0,74	0.50
2661-20	31	31,8	1.25	45,7	1.80	14,0	200 †	56,0	800	200,0	8.0	94,8	28	1,34	0.90
2661-24	38	38,1	1.50	52,3	2.06	10,5	150 †	42,0	600	255,0	10.0	94,8	28	1,68	1.13
2661-32	51	50,8	2.00	64,8	2.55	7,0	100 †	28,0	400	300,0	12.0	94,8	28	1,93	1.30
2661-40	63	63,5	2.50	78,2	3.08	4,0	62	16,0	225	355,0	14.0	94,8	28	2,56	1.72
2661-48 ‡	80	76,2	3.00	90,9	3.58	4,0	62	16,0	225	460,0	18.0	94,8	28	2,92	1.96
2661-64 ‡	102	101,6	4.00	119,1	4.69	3,5	50	14,0	200	610,0	24.0	94,8	28	4,58	3.08

† Maximum working pressure for band clamp type fittings is 3,4 bar [50 psi].

‡ Sold as bulk hose only.

Construction

Tube: AQP elastomer

Reinforcement: Helical wire between two textile braids

Cover: Blue AQP elastomer

Operating parameters

-40°C to +150°C
(-40°F to +302°F)

Application

- Suction and transfer applications for petroleum and fire resistant hydraulic fluids, fuel, lubricating oils, gasoline, water and many other industrial fluids

For more information on agency listings, specific fluid applications and high temperature ratings see section A.

Fitting reference	Page
Crimp	
TTC (-12 thru -32)	H-5-56
OTC	H-5-56
Skive nipple (-12 thru -20)	H-5-56
Socket data	H-4

Hydraulic hose

Thermoplastic hose

B

3130

SYNFLEX Medium pressure

Meets: SAE 100R7



# Part number	Hose size	Hose I.D.			Nominal Hose O.D.		Maximum operating pressure		Minimum burst pressure		Minimum bend radius		Weight		Length	
		DN	mm	in	mm	in	bar	psi	bar	psi	mm	in	kg/m	lbs/ft	mtr	ft
3130-02	-02	3	3,2	0.13	8,5	0.34	172	2,500	689	10,000	13,0	0.50	0,04	0.03	Bulk	Bulk
3130-02-250BX	-02	3	3,2	0.13	8,5	0.34	172	2,500	689	10,000	13,0	0.50	0,04	0.03	76,2	250
3130-03	-03	5	4,8	0.19	10,8	0.43	207	3,000	827	12,000	19,0	0.75	0,07	0.05	Bulk	Bulk
3130-03-250BX	-03	5	4,8	0.19	10,8	0.43	207	3,000	827	12,000	19,0	0.75	0,07	0.05	76,2	250
3130-04	-04	6	6,4	0.25	13,0	0.51	207	3,000	759	11,000	32,0	1.25	0,09	0.06	Bulk	Bulk
3130-04-250BX	-04	6	6,4	0.25	13,0	0.51	207	3,000	759	11,000	32,0	1.25	0,09	0.06	76,2	250
3130-04-500R	-04	6	6,4	0.25	13,0	0.51	207	3,000	759	11,000	32,0	1.25	0,09	0.06	152,4	500
3130-05	-05	8	7,9	0.31	15,1	0.59	172	2,500	689	10,000	44,0	1.75	0,12	0.08	Bulk	Bulk
3130-05-250BX	-05	8	7,9	0.31	15,1	0.59	172	2,500	689	10,000	44,0	1.75	0,12	0.08	76,2	250
3130-06	-06	10	9,5	0.38	17,0	0.67	155	2,250	620	9,000	51,0	2.00	0,12	0.08	Bulk	Bulk
3130-06-250BX	-06	10	9,5	0.38	17,0	0.67	155	2,250	620	9,000	51,0	2.00	0,12	0.08	76,2	250
3130-06-500R	-06	10	9,5	0.38	17,0	0.67	155	2,250	620	9,000	51,0	2.00	0,12	0.08	152,4	500
3130-08	-08	12	12,7	0.50	20,7	0.82	138	2,000	620	9,000	76,0	3.00	0,16	0.11	Bulk	Bulk
3130-08-250BX	-08	12	12,7	0.50	20,7	0.82	138	2,000	620	9,000	76,0	3.00	0,16	0.11	76,2	250
3130-08-500R	-08	12	12,7	0.50	20,7	0.82	138	2,000	620	9,000	76,0	3.00	0,16	0.11	152,4	500
3130-12	-12	19	19,1	0.75	27,1	1.07	86	1,250	345	5,000	127,0	5.00	0,27	0.18	Bulk	Bulk
3130-12-200BX	-12	19	19,1	0.75	27,1	1.07	86	1,250	345	5,000	127,0	5.00	0,27	0.18	60,9	200
3130-16	-16	25	25,4	1.00	34,0	1.34	69	1,000	276	4,000	203,0	8.00	0,46	0.31	Bulk	Bulk
3130-16-200BX	-16	25	25,4	1.00	34,0	1.34	69	1,000	276	4,000	203,0	8.00	0,46	0.31	60,9	200

SAE100R7 does not apply to 0.125" size. The nylon core tube is a single wall and not bonded to the reinforcement.

Construction

Tube: Nylon-lined

Reinforcement: Spiral or braided synthetic fiber

Cover: Black perforated polyurethane

Operating parameters

-40°C to +100°C
(-40°F to +212°F) or

-40°C to +66°C
(-40°F to +150°F)
with water-based, or
fire-resistant, fluids

Change in working length at
working PSI ±2%

Application

- General hydraulics
- Material handling
- Forklifts
- Chemical transfer
- Marine steering

Features

- Low elongation

Fitting reference

For hose fittings details refer to
Synflex catalog E-HOOV-MC001-E.

3740

SYNFLEX Medium pressure, non-conductive

Meets or exceeds SAE 100R7



#	Hose size	Hose I.D.		Nominal Hose O.D.		Maximum operating pressure		Minimum burst pressure		Minimum bend radius		Weight		Length		
		DN	mm	in	mm	in	bar	psi	bar	psi	mm	in	kg/m	lbs/ft	mtr	ft
3740-12	-12	19	19,0	0.75	27,2	1.07	86	1,250	345	5,000	127,0	7.0	0,29	0.19	Bulk	Bulk
3740-12-200BX	-12	19	19,0	0.75	27,2	1.07	86	1,250	345	5,000	127,0	7.0	0,29	0.19	60,9	200
3740-16	-16	25	25,4	1.00	34,1	1.34	69	1,000	276	4,000	203,0	8.0	0,39	0.26	Bulk	Bulk

Construction

Tube: Nylon-lined

Reinforcement: Braided synthetic fiber reinforcement (-08)

Cover: Orange non-perforated polyurethane

Operating parameters

-40°C to +100°C
(-40°F to +212°F) or

-40°C to +60°C
(-40°F to +140°F)
with water-based, or
fire-resistant, fluids

Change in working length at
working PSI \pm 2%

Application

- General hydraulic systems that may contact high voltage sources
- Aerial equipment
- Mobile hydraulics
- Rescue apparatus and tools

Features

- SAE J517 non-conductive hose construction
- Less than 50 micro-amperes leakage when subjected to 75,000 volts/ft for five minutes

Fitting reference

For hose fittings details refer to Synflex catalog E-HOOV-MC001-E.

Hydraulic hose

Thermoplastic hose

B

37AL

SYNFLEX Medium pressure, non-conductive



Meets: SAE 100R7 conductive requirements

# Part number	Hose size	Hose I.D.			Nominal Hose O.D.		Maximum operating pressure				Minimum burst pressure		Minimum bend radius		Weight		Length	
		DN	mm	in	mm	in	bar	psi	bar	psi	bar	psi	mm	in	kg/m	lbs/ft	mtr	ft
37AL-03	-03	5	4,8	0.19	10,8	0.43	207	3,000	207	3,000	827	12,000	19,0	0.4	0,07	0.05	Bulk	Bulk
37AL-03-250BX	-03	5	4,8	0.19	10,8	0.43	207	3,000	207	3,000	827	12,000	19,0	0.4	0,07	0.05	76,2	250
37AL-04	-04	6	6,4	0.25	12,3	0.49	207	3,000	190	2,750	759	11,000	32,0	1.3	0,09	0.06	Bulk	Bulk
37AL-04-250BX	-04	6	6,4	0.25	12,3	0.49	207	3,000	190	2,750	759	11,000	32,0	1.3	0,09	0.06	76,2	250
37AL-04-500RC	-04	6	6,4	0.25	12,3	0.49	207	3,000	190	2,750	759	11,000	32,0	1.3	0,09	0.06	152,4	500
37AL-05	-05	8	7,9	0.31	14,7	0.58	207	3,000	172	2,500	689	10,000	44,0	1.8	0,11	0.08	Bulk	Bulk
37AL-05-250BX	-05	8	7,9	0.31	14,7	0.58	207	3,000	172	2,500	689	10,000	44,0	1.8	0,11	0.08	76,2	250
37AL-05-500RC	-05	8	7,9	0.31	14,7	0.58	207	3,000	172	2,500	689	10,000	44,0	1.8	0,11	0.08	152,4	500
37AL-06	-06	10	9,5	0.38	16,1	0.64	207	3,000	155	2,250	620	9,000	51,0	2.0	0,14	0.10	Bulk	Bulk
37AL-06-250BX	-06	10	9,5	0.38	16,1	0.64	207	3,000	155	2,250	620	9,000	51,0	2.0	0,14	0.10	76,2	250
37AL-06-500RC	-06	10	9,5	0.38	16,1	0.64	207	3,000	155	2,250	620	9,000	51,0	2.0	0,14	0.10	152,4	500
37AL-08	-08	12	12,7	0.50	20,7	0.82	207	3,000	155	2,250	620	9,000	76,0	3.0	0,21	0.14	Bulk	Bulk
37AL-08-250BX	-08	12	12,7	0.50	20,7	0.82	207	3,000	155	2,250	620	9,000	76,0	3.0	0,21	0.14	76,2	250
37AL-08-500RC	-08	12	12,7	0.50	20,7	0.82	207	3,000	155	2,250	620	9,000	76,0	3.0	0,21	0.14	152,4	500

Construction

Tube: Polyester

Reinforcement: Braided synthetic fiber

Cover: Orange, non-perforated, non-stick polyurethane

Operating parameters

-54°C to +100°C
(-65°F to +212°F) or

-40°C to +60°C
(-40°F to +140°F)
with water-based, or fire-resistant, fluids

Change in working length at working PSI \pm 2%

Application

- Electric utility truck
- Hydraulic systems
- Mobile equipment (pickers, utility vehicles)

Features

- SAE J517 non-conductive hose construction
- Complies with ANSI A92.2 for vehicle-mounted, aerial devices (i.e., AL)
- Less than 50 micro-amperes leakage when subjected to 75,000 volts/ft for five minutes

Fitting reference

For hose fittings details refer to Synflex catalog E-HOOV-MC001-E.

3R80

SYNFLEX High pressure

Meets: SAE 100R8 conductive requirements



#	Hose size	Hose I.D.			Nominal Hose O.D.		Maximum operating pressure		Minimum burst pressure		Minimum bend radius		Weight		Length	
		DN	mm	in	mm	in	bar	psi	bar	psi	mm	in	kg/m	lbs/ft	mtr	ft
3R80-03	-03	5	4,8	0.19	13,1	0.52	350	5,100	1,400	20,400	38,0	1.50	0,11	0.08	Bulk	Bulk
3R80-03-250BX	-03	5	4,8	0.19	13,1	0.52	350	5,100	1,400	20,400	38,0	1.50	0,11	0.08	76,2	250
3R80-04	-04	6	6,4	0.25	15,9	0.63	350	5,100	1,400	20,400	51,0	2.00	0,18	0.12	Bulk	Bulk
3R80-04-250BX	-04	6	6,4	0.25	15,9	0.63	350	5,100	1,400	20,400	51,0	2.00	0,18	0.12	76,2	250
3R80-06	-06	10	9,5	0.38	19,4	0.77	280	4,050	1,120	16,200	64,0	2.50	0,22	0.15	Bulk	Bulk
3R80-06-250BX	-06	10	9,5	0.38	19,4	0.77	280	4,050	1,120	16,200	64,0	2.50	0,22	0.15	76,2	250
3R80-08	-08	12	12,7	0.50	22,7	0.90	245	3,550	980	14,200	102,0	4.00	0,28	0.19	Bulk	Bulk
3R80-08-250BX	-08	12	12,7	0.50	22,7	0.90	245	3,550	980	14,200	102,0	4.00	0,28	0.19	76,2	250
3R80-12	-12	19	19,1	0.75	28,9	1.14	157	2,300	628	9,200	165,0	6.50	0,38	0.26	Bulk	Bulk
3R80-12-200BX	-12	19	19,1	0.75	28,9	1.14	157	2,300	628	9,200	165,0	6.50	0,38	0.26	60,9	200
3R80-16	-16	25	25,4	1.00	37,3	1.47	140	2,050	560	8,200	254,0	10.00	0,57	0.39	Bulk	Bulk
3R80-16-200BX	-16	25	25,4	1.00	37,3	1.47	140	2,050	560	8,200	254,0	10.00	0,57	0.39	60,9	200

Construction

Tube: Nylon

Reinforcement: Braided, synthetic fiber

Cover: Black perforated polyurethane

Operating parameters

-40°C to +100°C
(-40°F to +212°F) or

-40°C to +66°C
(-40°F to +150°F)
with water-based, or fire-resistant, fluids

Change in working length at working PSI \pm 2%

Application

- General hydraulic systems
- Hydraulic tools
- Mobile equipment
- High-pressure chemical transfer

Fitting reference

For hose fittings details refer to Synflex catalog E-HOOV-MC001-E.

Hydraulic hose

Thermoplastic hose

B

3E80

SYNFLEX High pressure, non-conductive



Meets: SAE 100R8

# Part number	Hose size	Hose I.D.		Nominal Hose O.D.		Maximum operating pressure		Minimum burst pressure		Minimum bend radius		Weight		Length		
		DN	mm	in	mm	in	bar	psi	bar	psi	mm	in	kg/m	lbs/ft	mtr	ft
3E80-03	-03	5	4,8	0.19	13,1	0.52	350	5,100	1,400	20,400	38,0	1.50	0,11	0.08	Bulk	Bulk
3E80-04	-04	6	6,4	0.25	15,9	0.63	350	5,100	1,400	20,400	51,0	2.00	0,18	0.12	Bulk	Bulk
3E80-04-250BX	-04	6	6,4	0.25	15,9	0.63	350	5,100	1,400	20,400	51,0	2.00	0,18	0.12	76,2	250
3E80-06	-06	10	9,5	0.38	19,4	0.77	280	4,050	1,120	16,200	64,0	2.50	0,22	0.15	Bulk	Bulk
3E80-06-250BX	-06	10	9,5	0.38	19,4	0.77	280	4,050	1,120	16,200	64,0	2.50	0,22	0.15	76,2	250
3E80-08	-08	12	12,7	0.50	22,7	0.90	245	3,550	980	14,200	102,0	4.00	0,28	0.19	Bulk	Bulk
3E80-08-250BX	-08	12	12,7	0.50	22,7	0.90	245	3,550	980	14,200	102,0	4.00	0,28	0.19	76,2	250
3E80-12‡	-12	19	19,1	0.75	28,9	1.14	157	2,300	628	9,200	165,0	6.50	0,38	0.26	Bulk	Bulk
3E80-16‡	-16	25	25,4	1.00	37,3	1.47	140	2,050	560	8,200	254,0	10.00	0,57	0.39	Bulk	Bulk

‡Run to order (RTO) hose. Contact your Eaton customer service representative for details.

Construction

Tube: Nylon

Reinforcement: Braided synthetic fiber

Cover: Orange, non-perforated polyurethane

Operating parameters

-54°C to +100°C
(-65°F to +212°F) or

-40°C to +66°C
(-40°F to +150°F)
with water-based, or fire-resistant, fluids

Change in working length at working PSI ±2%

Application

- General hydraulic systems that may contact high voltage sources
- Aerial equipment
- Mobile machinery
- Rescue tools

Features

- SAE J517 non-conductive hose construction
- Less than 50 micro-amperes leakage when subjected to 75,000 volts/ft for five minutes

Fitting reference

For hose fittings details refer to Synflex catalog E-HOOV-MC001-E.

30CT

SYNFLEX Constant pressure

Meets: SAE 100R18



#	Hose size	Hose I.D.			Nominal Hose O.D.		Maximum operating pressure		Minimum burst pressure		Minimum bend radius		Weight		Length	
		DN	mm	in	mm	in	bar	psi	bar	psi	mm	in	kg/m	lbs/ft	mtr	ft
30CT-03	-03	5	4,8	0.19	10,7	0.42	210	3,050	840	12,200	25,4	1.00	0,08	0.05	Bulk	Bulk
30CT-04	-04	6	6,4	0.25	12,1	0.48	210	3,050	840	12,200	31,8	1.25	0,09	0.06	Bulk	Bulk
30CT-04-250BX	-04	6	6,4	0.25	12,1	0.48	210	3,050	840	12,200	31,8	1.25	0,09	0.06	76,2	250
30CT-05	-05	8	7,9	0.31	15,5	0.61	210	3,050	840	12,200	38,1	1.50	0,15	0.10	Bulk	Bulk
30CT-05-250BX	-05	8	7,9	0.31	15,5	0.61	210	3,050	840	12,200	38,1	1.50	0,15	0.10	76,2	250
30CT-06	-06	10	9,5	0.38	16,8	0.66	210	3,050	840	12,200	50,8	2.00	0,18	0.12	Bulk	Bulk
30CT-06-250BX	-06	10	9,5	0.38	16,8	0.66	210	3,050	840	12,200	50,8	2.00	0,18	0.12	76,2	250
30CT-08	-08	12	12,7	0.50	21,6	0.85	210	3,050	840	12,200	88,9	3.50	0,25	0.17	Bulk	Bulk
30CT-08-250BX	-08	12	12,7	0.50	21,6	0.85	210	3,050	840	12,200	88,9	3.50	0,25	0.17	76,2	250
30CT-10	-10	16	16,0	0.63	27,0	1.06	210	3,050	840	12,200	101,6	4.00	0,41	0.28	Bulk	Bulk
30CT-10-250BX	-10	16	16,0	0.63	27,0	1.06	210	3,050	840	12,200	101,6	4.00	0,41	0.28	76,2	250

Construction

Tube: Polyester

Reinforcement: Braided synthetic fiber

Cover: Black perforated, non-stick polyester

Operating parameters

-54°C to +94°C
(-65°F to +200°F) or

-54°C to +66°C
(-65°F to +150°F)
with water-based, or
fire-resistant, fluids

Change in working length at
working PSI ±2%

Application

- Forklifts
- Construction
- General hydraulics
- Chemical and gas transfer
- Agricultural equipment
- Material handling
- Freezer applications
- Machine tools and robotics
- Lubrication equipment
- Portable hydraulic tools

Features

- Highly flexible, even in cold temperatures
- Small outside diameter
- Lightweight, yet rugged construction

Fitting reference

For hose fittings details refer to Synflex catalog E-HOOV-MC001-E.

Hydraulic hose

Thermoplastic hose

B

3V10

SYNFLEX Very high pressure



# Part number	Hose size	Hose I.D.			Nominal Hose O.D.		Maximum operating pressure		Minimum burst pressure		Minimum bend radius		Weight		Length	
		DN	mm	in	mm	in	bar	psi	bar	psi	mm	in	kg/m	lbs/ft	mtr	ft
3V10-03	-03	5	4,8	0.19	13,2	0.52	689	10,000	2,758	40,000	38,0	1.50	0,11	0.08	Bulk	Bulk
3V10-03-250BX	-03	5	4,8	0.19	13,2	0.52	689	10,000	2,758	40,000	38,0	1.50	0,11	0.08	76,2	250
3V10-04	-04	6	6,4	0.25	15,1	0.60	689	10,000	2,758	40,000	64,0	2.50	0,16	0.11	Bulk	Bulk
3V10-04-250BX	-04	6	6,4	0.25	15,1	0.60	689	10,000	2,758	40,000	64,0	2.50	0,16	0.11	76,2	250
3V10-06	-06	10	9,5	0.38	19,8	0.78	552	8,000	2,205	32,000	76,0	3.00	0,23	0.16	Bulk	Bulk
3V10-06-250BX	-06	10	9,5	0.38	19,8	0.78	552	8,000	2,205	32,000	76,0	3.00	0,23	0.16	76,2	250

Construction

Tube: Nylon-lined

Reinforcement: Spiral, high tensile aramid fiber

Cover: Black, perforated polyurethane

Operating parameters

-40°C to +66°C
(-40°F to +150°F)

Change in working length at working PSI \pm 2%

Application

- High pressure hydraulic tools
- Rescue equipment and tools
- High pressure test equipment

Features

- Compact size
- Lightweight
- Low elongation



3V10 hose assembly includes:

- 3V10 hose
- 90V permanent steel fitting
- 45J0 hose guard
- Warning tag



Fitting reference

For hose fittings details refer to Synflex® catalog E-HOOV-MC001-E.

3VE0

SYNFLEX Very high pressure, non-conductive



# Part number	Hose size	Hose I.D.			Nominal Hose O.D.		Maximum operating pressure		Minimum burst pressure		Minimum bend radius		Weight		Length	
		DN	mm	in	mm	in	bar	psi	bar	psi	mm	in	kg/m	lbs/ft	mtr	ft
3VE0-03	-03	5	4,8	0.19	13,2	0.52	689	10,000	2,758	40,000	38,0	1.50	0,11	0.08	Bulk	Bulk
3VE0-03-250BX	-03	5	4,8	0.19	13,2	0.52	689	10,000	2,758	40,000	38,0	1.50	0,11	0.08	76,2	250
3VE0-04	-04	6	6,4	0.25	15,1	0.60	689	10,000	2,758	40,000	64,0	2.50	0,16	0.11	Bulk	Bulk
3VE0-04-250BX	-04	6	6,4	0.25	15,1	0.60	689	10,000	2,758	40,000	64,0	2.50	0,16	0.11	76,2	250
3VE0-06	-06	10	9,5	0.38	19,8	0.78	551	8,000	2,206	32,000	76,0	3.00	0,23	0.16	Bulk	Bulk
3VE0-06-250BX	-06	10	9,5	0.38	19,8	0.78	551	8,000	2,206	32,000	76,0	3.00	0,23	0.16	76,2	250

Synflex 3VE0 hose is available only as completed assemblies through the factory or Eaton Synflex authorized assemblers.

Construction

Tube: Nylon-lined

Reinforcement: Spiral high-tensile aramid fiber

Cover: Orange, non-perforated polyurethane

Operating parameters

-40°C to +66°C
(-40°F to +150°F)

Change in working length at working PSI \pm 2%

Application

- General hydraulic systems that may contact high voltage sources
- Rescue equipment and tools
- Mobile machinery
- Aerial equipment

Features

- SAE J517 non-conductive hose construction. Less than 50 micro-amperes leakage when subjected to 75,000 volts/ft for five minutes
- Compact size
- Low elongation



3VE0 hose assembly includes:

- 3VE0 hose
- 90V permanent steel fitting
- 45JO hose guard
- Warning tag



Fitting reference

For hose fittings details refer to Synflex® catalog E-HOOV-MC001-E.

Hydraulic hose

Thermoplastic hose

B

3130, 37AL and 30CT

Twin-Line Thermoplastic Hose

3130 medium pressure hose

Meets: SAE 100R7



# Part number	Hose size	Number of hose	Hose I.D.		Length	
			mm	in	mtr	ft
3130-04-2-250BX*	3130-04	2	6,3	0.25	76,2	250
3130-05-2-250BX*	3130-05	2	7,9	0.31	76,2	250
3130-06-2-250BX*	3130-06	2	9,7	0.38	76,2	250
3130-08-2-250BX*	3130-08	2	12,7	0.50	76,2	250

* 3130 Twin-Line hose is a stock item. Other 3130 multi-line hoses are built to order. See 3130 series hose on page B-44 for specification details.

Please contact Eaton customer service for twin-line, tri-line, and multi-line configuration options.

37AL medium pressure hose, non-conductive

Meets: SAE 100R7 conductive requirements



# Part number	Hose size	Number of hose	Hose I.D.		Length	
			mm	in	mtr	ft
37AL-04-2-250BX*	37AL-04	2	6,3	0.25	76,2	250
37AL-06-2-250BX*	37AL-06	2	9,7	0.38	76,2	250
37AL-08-2-250BX*	37AL-08	2	12,7	0.50	76,2	250

* 37AL Twin-Line hose is a stock item. Other 37AL multi-line hoses are built to order. See 37AL series hose on page B-46 for specification details.

Please contact Eaton customer service for twin-line, tri-line, and multi-line configuration options.

30CT constant pressure hose

Meets: SAE 100R18



# Part number	Hose size	Number of hose	Hose I.D.		Length	
			mm	in	mtr	ft
30CT-04-2-250BX*	30CT-04	2	6,3	0.25	76,2	250
30CT-05-2-250BX*	30CT-05	2	7,9	0.31	76,2	250
30CT-06-2-250BX*	30CT-06	2	9,7	0.38	76,2	250
30CT-08-2-250BX*	30CT-08	2	12,7	0.50	76,2	250

* 30CT Twin-Line hose is a stock item. Other 30CT multi-line hoses are built to order. See 30CT series hose on page B-49 for specification details.

Please contact Eaton customer service for twin-line, tri-line, and multi-line configuration options.

Twin-Line and multi-line hose separating tool and instructions are in the Synflex Thermoplastic Hose and Fittings catalog E-HOOV-MC001-E.

Fitting reference

For hose fittings details refer to Synflex catalog E-HOOV-MC001-E.

General purpose hose

H201	C-3	FC466	C-7	C
FC332	C-4	2583	C-7	
FC647	C-4	2580	C-8	
2556/2565	C-5	1503	C-9	
FC598	C-6	2651	C-10	
FC498	C-6			

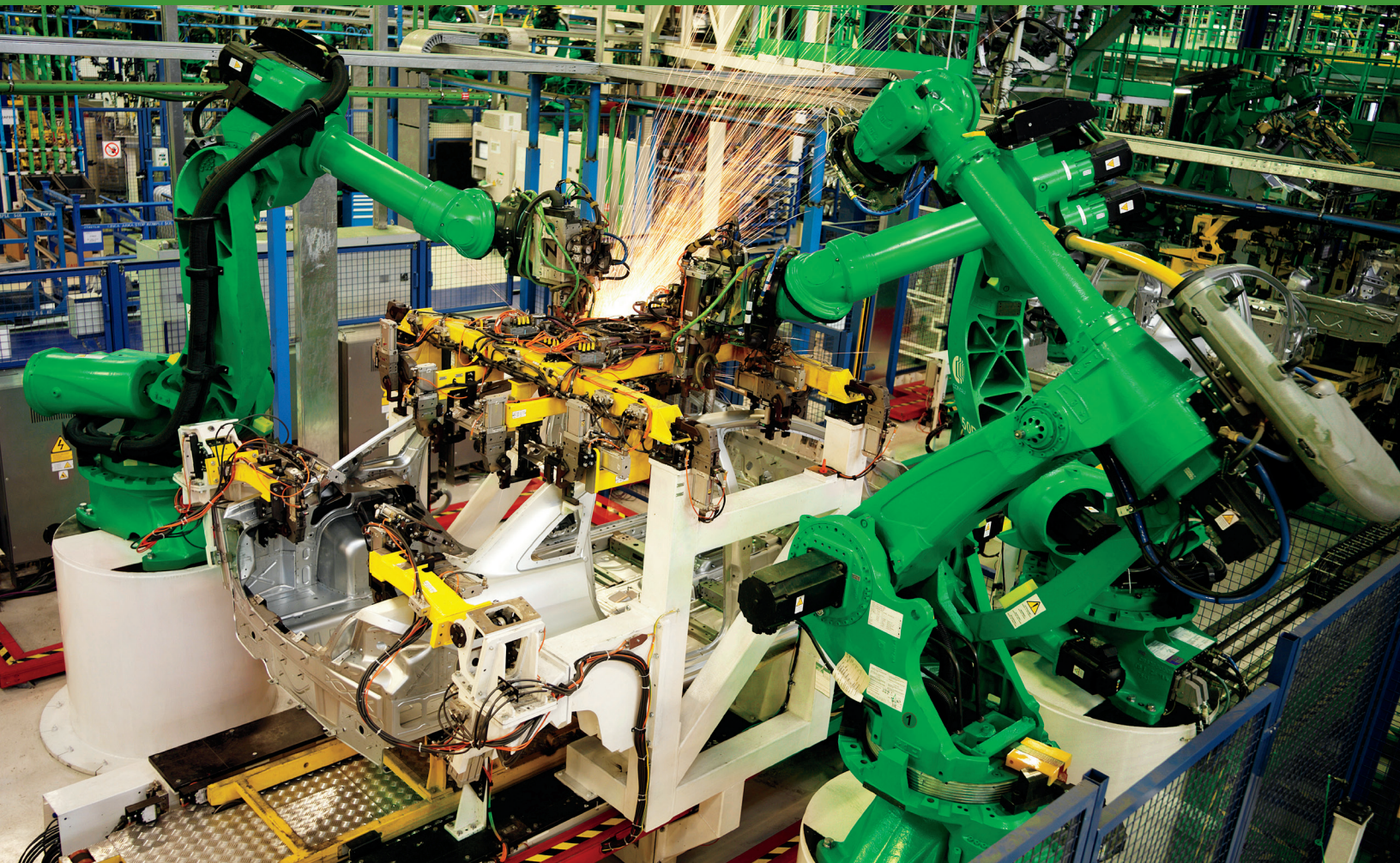

General purpose

C

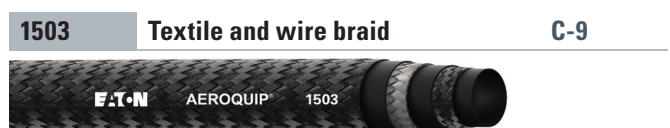
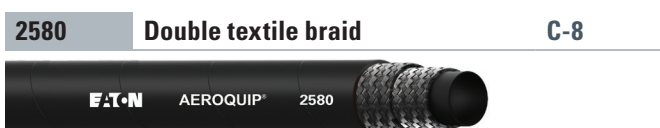
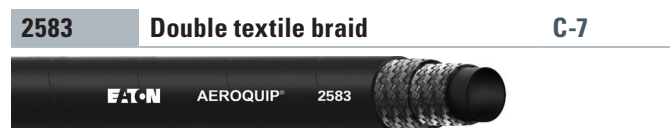
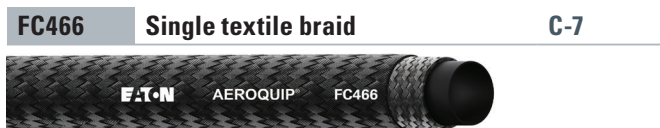

H201

Low pressure SOCKETLESS



# Part number	Hose I.D.			Hose O.D.		Maximum operating pressure		Minimum burst pressure		Minimum bend radius		Weight		Length	Vacuum
	DN	mm	in	mm	in	bar	psi	bar	psi	mm	in	kg/m	lbs/ft	ft.	in/Hg
H20104XX	6	6,4	0.25	12,7	0.50	21,0	300	84,0	1200	76,2	3.00	0,13	0.09	250	28
H20104XX-250R**	6	6,4	0.25	12,7	0.50	21,0	300	84,0	1200	76,2	3.00	0,13	0.09	250	28
H20104XX-500R	6	6,4	0.25	12,7	0.50	21,0	300	84,0	1200	76,2	3.00	0,13	0.09	500	28
H20105GY-250R*	8	7,9	0.31	15,1	0.59	21,0	300	84,0	1200	76,2	3.00	0,16	0.11	250	28
H20105GY-500R*	8	7,9	0.31	15,1	0.59	21,0	300	84,0	1200	76,2	3.00	0,16	0.11	500	28
H20106XX	10	9,5	0.38	16,7	0.65	21,0	300	84,0	1200	76,2	3.00	0,19	0.13	50	28
H20106XX-250R**	10	9,5	0.38	16,7	0.65	21,0	300	84,0	1200	76,2	3.00	0,19	0.13	250	28
H20106XX-500R	10	9,5	0.38	16,7	0.65	21,0	300	84,0	1200	76,2	3.00	0,19	0.13	500	28
H20108XX	13	12,7	0.50	19,1	0.75	21,0	300	84,0	1200	127,0	5.00	0,22	0.15	50	28
H20108XX-250R**	13	12,7	0.50	19,1	0.75	21,0	300	84,0	1200	127,0	5.00	0,22	0.15	250	28
H20108XX-500R	13	12,7	0.50	19,1	0.75	21,0	300	84,0	1200	127,0	5.00	0,22	0.15	500	28
H20110XX	16	15,9	0.63	23,8	0.93	21,0	300	84,0	1200	152,4	6.00	0,34	0.23	50	28
H20110XX-250R	16	15,9	0.63	23,8	0.93	21,0	300	84,0	1200	152,4	6.00	0,34	0.23	250	28
H20112XX	19	19,1	0.75	26,2	1.03	21,0	300	84,0	1200	152,4	6.00	0,39	0.26	50	28
H20112XX-250R	19	19,1	0.75	26,2	1.03	21,0	300	84,0	1200	152,4	6.00	0,39	0.26	250	28
H20116XX	25	25,4	1.00	35,0	1.39	14,0	200	55,0	800	254,0	10.0	0,57	0.38	50	18
H20116XX-250R	25	25,4	1.00	35,0	1.39	14,0	200	55,0	800	254,0	10.0	0,57	0.38	250	18

*Only available in gray (GY)

** Green (GN), gray (GY) and yellow (YW) available.

All sizes (except -05) available in black (BK), blue (BU) and red (RD).

Construction

Tube: Nitrile

Reinforcement: Single textile braid

Cover: Neoprene (black hose), vinyl nitrile (colored hose) (Red, green, and black are MSHA approved)

Operating parameters

-40°F to +260°F (-40°C to +127°C)

Air and water applications
-40°F to +212°F (-40°C to +100°C)

Oil applications
-40°F to +260°F (-40°C to +127°C)

Application

- Fuel, lubricating oils, air and water
- In-plant robotic manufacturing
- Air lines and air tools

Red, green, and black are MSHA approved

For more information on agency listings, specific fluid applications and high temperature ratings see section A.

Fitting reference	Page
Reusable	
SOCKETLESS	I-48-53

General purpose

C

FC332 AQP SOCKETLESS™



# Part number	Hose I.D.			Hose O.D.		Maximum operating pressure		Minimum burst pressure		Minimum bend radius		Vacuum service		Weight	
	DN	mm	in	mm	in	bar	psi	bar	psi	mm	in	kPa	in/Hg	kg/m	lbs/ft
FC332-04	6	6,4	0.25	12,4	0.49	20,0	300	82,0	1200	76,2	3.00	94,8	28	0,12	0.08
FC332-06	10	9,7	0.38	16,0	0.63	20,0	300	82,0	1200	76,2	3.00	94,8	28	0,18	0.12
FC332-08	13	12,7	0.50	19,1	0.75	20,0	300	82,0	1200	127,0	5.00	94,8	28	0,22	0.15
FC332-10	16	16,0	0.63	23,1	0.91	20,0	300	82,0	1200	152,4	6.00	60,9	18	0,30	0.20
FC332-12	19	19,1	0.75	26,4	1.04	20,0	300	82,0	1200	177,8	7.00	60,9	18	0,42	0.28

Construction

Tube: AQP elastomer
Reinforcement: Textile braid
Cover: AQP elastomer

Operating parameters

-40°C to +150°C
 (-40°F to +302°F) or
 Water not to exceed
 +82°C (+180°F)
 Air not to exceed
 +121°C (+250°F)

Application

- For gasoline, diesel, fuel and lubricating oils, air and water
- Not recommended for hydraulic impulse applications and not approved for air brake applications

For more information on agency listings, specific fluid applications and high temperature ratings see section A.

Fitting reference	Page
Reusable	
SOCKETLESS	I-48-53

FC647 Low pressure SOCKETLESS™

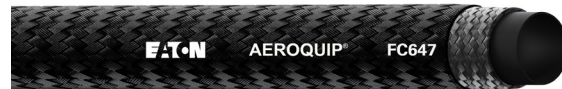

# Part number	Hose I.D.			Hose O.D.		Maximum operating pressure		Burst pressure		Minimum bend radius		Vacuum service		Weight	
	DN	mm	in	mm	in	bar	psi	bar	psi	mm	in	kPa	in/Hg	kg/m	lbs/ft
FC647-04*	6	6,4	0.25	13,2	0.52	25,0	360	99,0	1440	76,2	3.00	94,8	28	0,09	0.06
FC647-06*	10	9,7	0.38	16,8	0.66	21,0	300	84,0	1200	76,2	3.00	94,8	28	0,15	0.09
FC647-08*	13	12,7	0.50	20,1	0.79	21,0	300	84,0	1200	127,0	5.00	94,8	28	0,18	0.12
FC647-10*	16	16,0	0.63	23,4	0.92	17,0	250	70,0	1000	152,4	6.00	60,9	18	0,24	0.16
FC647-12*	19	19,1	0.75	26,7	1.05	17,0	250	70,0	1000	177,8	7.00	60,9	18	0,27	0.18

Construction

Tube: Synthetic rubber
Reinforcement: Textile braid
Cover: Polyester braided

Operating parameters

-40°C to +100°C
 (-40°F to +212°F)
 Water not to exceed
 +66°C (+150°F)
 Air not to exceed
 +74°C (+165°F)

Application

- For gasoline, fuel and lubricating oils, air and water
- Not recommended for hydraulic impulse applications and not approved for air brake applications

For more information on agency listings, specific fluid applications and high temperature ratings see section A.

***NOTE:** You must insert the correct color code in the complete part number. Color codes are BLK = black, BLU = blue, GRN = green.

Example: FC647-04GRN is a green cover in dash size 4.
 Not all sizes are available in all colors.

Fitting reference	Page
Reusable	
SOCKETLESS	I-48-53

2556/2565

Low pressure SOCKETLESS™

Meets: SAE 20R2 Type 1, MIL-H-24136/3



# Part number	Hose I.D.			Hose O.D.		Maximum operating pressure		Minimum burst pressure		Minimum bend radius		Vacuum service		Weight	
	DN	mm	in	mm	in	bar	psi	bar	psi	mm	in	kPa	in/Hg	kg/m	lbs/ft
2556															
2556-4	6	6,4	0.25	12,4	0.49	25,0	360	99,0	1440	76,2	3.00	94,8	28	0,12	0.08
2556-6	10	9,7	0.38	15,7	0.62	21,0	300	84,0	1200	76,2	3.00	94,8	28	0,18	0.12
2556-8	13	12,7	0.50	19,1	0.75	21,0	300	84,0	1200	127,0	5.00	94,8	28	0,24	0.16
2556-10	16	16,0	0.63	23,1	0.91	17,0	250	70,0	1000	152,4	6.00	61,0	18	0,31	0.21
2556-12	19	19,1	0.75	26,2	1.03	17,0	250	70,0	1000	177,8	7.00	61,0	18	0,37	0.25
2565															
2565-4	6	6,4	0.25	12,7	0.50	21,0	300	87,0	1250	57,2	2.25	67,7	20	0,13	0.09
2565-6	10	9,7	0.38	16,0	0.63	17,0	250	70,0	1000	76,2	3.00	67,7	20	0,16	0.11
2565-8	13	12,7	0.50	19,8	0.78	14,0	200	52,0	750	95,3	3.75	33,9	10	0,25	0.17
2565-10	16	16,0	0.63	24,6	0.97	12,0	175	49,0	700	120,7	4.75	33,9	10	0,42	0.28
2565-12	19	19,1	0.75	27,7	1.09	8,5	125	35,0	500	139,7	5.50	33,9	10	0,45	0.30

Construction

- Tube:** Synthetic rubber
- Reinforcement:** Textile braid
- Cover:** Synthetic rubber

Operating parameters

- 2556:** -40°C to +100°C (-40°F to +212°F)
Water not to exceed +66°C (+150°F)
Air not to exceed +160°C (+71°F)
- 2565:** -54°C to +121°C (-65°F to +250°F)
Water not to exceed +66°C (+150°F)
Air not to exceed +74°C (+165°F)

Application

- For gasoline, fuel and lubricating oils, air and water
- Not recommended for hydraulic impulse applications and not approved for air brake applications
- 2565 is a low-temperature synthetic rubber covered MILDTL-13444 Type 1, Class A hose

For more information on agency listings, specific fluid applications and high temperature ratings see section A.

Fitting reference	Page
Reusable SOCKETLESS	I-48-53

General purpose

C

FC598

Single textile braid

Exceeds: SAE 100R6



# Part number	Hose I.D.			Hose O.D.		Maximum operating pressure		Minimum burst pressure		Minimum bend radius		Vacuum service		Weight	
	DN	mm	in	mm	in	bar	psi	bar	psi	mm	in	kPa	in/Hg	kg/m	lbs/ft
FC598-04	6	6,4	0.25	12,2	0.50	28,0	400	112,0	1600	63,5	2.50	94,8	28	0,12	0.08
FC598-06	10	9,7	0.38	15,7	0.62	28,0	400	112,0	1600	75,0	3.00	94,8	28	0,19	0.13
FC598-08	13	12,7	0.50	19,1	0.78	28,0	400	112,0	1600	100,0	4.00	94,8	28	0,22	0.15
FC598-10	16	16,0	0.63	23,1	0.91	24,0	350	98,0	1400	125,0	5.00	60,9	18	0,30	0.20
FC598-12	19	19,1	0.75	26,2	1.03	24,0	350	98,0	1400	150,0	6.00	60,9	18	0,42	0.28

Construction

Tube: AQP elastomer

Reinforcement: Single textile braid

Cover: Black AQP elastomer

Operating parameters

-40°C to +150°C
(-40°F to +302°F)

Application

- Low pressure return lines in hydraulic systems

For more information on agency listings, specific fluid applications and high temperature ratings see section A.

Fitting reference	Page
OTC	H-5-56

FC498

Single textile braid

Meets or exceeds: SAE 100R6, EN 854 Type R6



# Part number	Hose I.D.			Hose O.D.		Maximum operating pressure		Minimum burst pressure		Minimum bend radius		Vacuum service		Weight	
	DN	mm	in	mm	in	bar	psi	bar	psi	mm	in	kPa	in/Hg	kg/m	lbs/ft
FC498-04	6	6,4	0.25	12,7	0.50	28,0	400	112,0	1600	63,5	2.50	94,8	28	0,12	0.08
FC498-06	10	9,7	0.38	15,7	0.62	28,0	400	112,0	1600	75,0	3.00	94,8	28	0,19	0.12
FC498-08	13	12,7	0.50	19,1	0.75	28,0	400	112,0	1600	100,0	4.00	94,8	28	0,22	0.15
FC498-10	16	16,0	0.63	23,1	0.91	24,0	350	98,0	1400	125,0	5.00	60,9	18	0,30	0.20
FC498-12	19	19,1	0.75	26,2	1.03	24,0	350	98,0	1400	150,0	6.00	60,9	18	0,42	0.28

Construction

Tube: AQP elastomer

Reinforcement: Single textile braid

Cover: Blue AQP elastomer cover

Operating parameters

-40°C to +150°C
(-40°F to +302°F)

Application

- Low pressure return lines in hydraulic systems

For more information on agency listings, specific fluid applications and high temperature ratings see section A.

Fitting reference	Page
OTC	H-5-56
SOCKETLESS	I-48-53

Qualified with SOCKETLESS fittings
NOTE: Pressure is reduced to 250 PSI

FC466

Single textile braid

Meets or exceeds: SAE 100R6, EN 854 Type R6



# Part number	Hose I.D.			Hose O.D.		Maximum operating pressure		Minimum burst pressure		Minimum bend radius		Vacuum service		Weight	
	DN	mm	in	mm	in	bar	psi	bar	psi	mm	in	kPa	in/Hg	kg/m	lbs/ft
FC466-04	7	6,4	0.25	12,7	0.50	28,0	400	112,0	1600	63,5	2.50	94,8	28	0,12	0.08
FC466-06	10	9,7	0.38	15,7	0.62	28,0	400	112,0	1600	75,0	3.00	94,8	28	0,19	0.13
FC466-08	13	12,7	0.50	19,1	0.75	28,0	400	112,0	1600	100,0	4.00	94,8	28	0,22	0.15
FC466-10	16	16,0	0.63	23,1	0.91	24,0	350	98,0	1400	125,0	5.00	60,9	18	0,30	0.20
FC466-12	19	19,1	0.75	26,2	1.03	24,0	350	98,0	1400	150,0	6.00	60,9	18	0,42	0.28

Construction

Tube: AQP elastomer tube
Reinforcement: Textile braid
Cover: Blue AQP elastomer cover

Operating parameters

-40°C to +150°C
 (-40°F to +302°F)

Application

- Low pressure return lines in hydraulic systems

For more information on agency listings, specific fluid applications and high temperature ratings see section A.

Fitting reference	Page
Crimp	
OTC	H-5-56

2583

Double textile braid

Meets: SAE 100R3, EN 854 Type R3



# Part number	Hose I.D.			Hose O.D.		Maximum operating pressure		Minimum burst pressure		Minimum bend radius		Weight	
	DN	mm	in	mm	in	bar	psi	bar	psi	mm	in	kg/m	lbs/ft
2583-4	6	6,4	0.25	14,5	0.57	87,0	1250	350,0	5000	76,2	3.00	0,18	0.12
2583-6	10	9,7	0.38	19,1	0.75	78,0	1125	315,0	4500	101,6	4.00	0,33	0.22
2583-8	13	12,7	0.50	23,9	0.94	70,0	1000	280,0	4000	127,0	5.00	0,39	0.26
2583-12	19	19,1	0.75	31,8	1.25	52,0	750	210,0	3000	152,4	6.00	0,71	0.48
2583-16	25	25,4	1.00	38,1	1.50	39,0	565	157,0	2250	203,2	8.00	0,76	0.51
2583-20	32	31,8	1.25	44,5	1.75	26,0	375	105,0	1500	254,0	10.00	1,09	0.73

Construction

Tube: Synthetic rubber tube
Reinforcement: Double textile braid
Cover: Synthetic rubber

Operating parameters

-40°C to +100°C
 (-40°F to +212°F)
 Air not to exceed +71°C (+161°F)

Application

- For hydraulics, fuel, lubricating oils, gasoline, air and water
- Not approved for air brake applications

For more information on agency listings, specific fluid applications and high temperature ratings see section A.

Fitting reference	Page
Crimp	
OTC	H-5-56

General purpose

C

2580

Double textile braid

Meets: MIL-H-24136/3



# Part number	Hose I.D.			Hose O.D.		Maximum operating pressure		Minimum burst pressure		Minimum bend radius		Weight	
	DN	mm	in	mm	in	bar	psi	bar	psi	mm	in	kg/m	lbs/ft
2580-4	5	4,8	0.19	13,2	0.52	70,0	1000	280,0	4000	76,2	3.00	0,18	0.12
2580-6	8	7,9	0.31	17,3	0.68	45,0	650	180,0	2600	101,6	4.00	0,25	0.17
2580-8	10	10,4	0.41	19,6	0.77	43,0	625	175,0	2500	117,3	4.62	0,28	0.19
2580-10	13	12,7	0.50	23,4	0.92	42,0	600	168,0	2400	139,7	5.50	0,42	0.28
2580-12	16	16,0	0.63	27,4	1.08	38,0	550	152,0	2200	165,1	6.50	0,51	0.34
2580-16	22	22,4	0.88	31,5	1.24	35,0	500	140,0	2000	187,5	7.38	0,54	0.36
2580-20	28	28,5	1.12	38,1	1.50	31,0	450	124,0	1800	228,6	9.00	0,64	0.43
2580-24	46	45,7	1.38	44,5	1.75	28,0	400	112,0	1600	266,7	10.50	0,76	0.51
2580-32	46	46,0	1.81	56,4	2.22	24,0	350	98,0	1400	336,6	13.25	1,12	0.75

Construction

Tube: Synthetic rubber

Reinforcement: Double textile braid

Cover: Synthetic rubber

For larger dash sizes, see Catalog A-MM-MC-0001-E.

Operating parameters

-40°C to +100°C
(-40°F to +212°F)

Application

- For water, gasoline, and fuel oil

For more information on agency listings, specific fluid applications and high temperature ratings see section A.

Fitting reference	Page
Reusable	
SAE 100R5 style	I-4-16

1503

Textile and wire braid

Meets: SAE 100R5, SAE J1402, DOT/FMVSS 106 Type All



# Part number	Hose I.D.			Hose O.D.		Maximum operating pressure		Minimum burst pressure		Minimum bend radius		Vacuum service		Weight	
	DN	mm	in	mm	in	bar	psi	bar	psi	mm	in	kPa	in/Hg	kg/m	lbs/ft
1503-4	5	4,8	0.19	13,2	0.52	210,0	3000	840,0	12000	76,2	3.00	94,8	28	0,19	0.13
1503-5	6	6,4	0.25	14,7	0.58	210,0	3000	840,0	12000	85,9	3.38	94,8	28	0,24	0.16
1503-6	8	7,9	0.31	17,3	0.68	157,0	2250	630,0	9000	101,6	4.00	94,8	28	0,27	0.23
1503-8	10	10,4	0.41	19,6	0.77	140,0	2000	560,0	8000	117,3	4.62	94,8	28	0,32	0.26
1503-10	12	12,7	0.50	23,4	0.92	122,0	1750	490,0	7000	139,7	5.50	94,8	28	0,49	0.37
1503-12	16	16,0	0.63	27,4	1.08	105,0	1500	420,0	6000	165,1	6.50	94,8	28	0,58	0.46
1503-16	19	22,4	0.88	31,2	1.23	56,0	800	224,0	3200	187,5	7.38	67,7	20 †	0,55	0.44
1503-20	25	28,4	1.12	38,1	1.50	43,0	625	175,0	2500	228,6	9.00	67,7	20 †	0,68	0.52
1503-24	31	35,1	1.38	44,5	1.75	35,0	500	140,0	2000	266,7	10.50	50,8	15 †	0,92	0.67
1503-32	38	46,0	1.81	56,6	2.23	24,0	350	98,0	1400	366,6	13.25	37,3	11 †	1,28	0.94
1503-40	60	60,1	2.38	73,2	2.88	24,0	350	98,0	1400	609,6	24.00	37,3	11 †	2,11	1.43

†Maximum negative pressures shown for -16 and larger are suitable only for those which has suffered no external damage or kinking. If greater negative pressures are required for -16 and larger hoses, the use of an internal support coil is recommended.

Construction

Tube: Synthetic rubber
Reinforcement: Textile inner braid, single wire braid
Cover: Black textile braid

Operating parameters

-40°C to +121°C
 (-40°F to +250°F)
 Air not to exceed
 +71°C (+160°F)

Application

- Hydraulics, air, gasoline, fuel and lubricating oils

For more information on agency listings, specific fluid applications and high temperature ratings see section A.

Fitting reference	Page
Crimp	
100R5	H-80-87
Reusable	
SAE 100R5 style	I-4-16

General purpose

C

2651

Double textile and wire braid

Meets: SAE 100R5



# Part number	Hose I.D.			Hose O.D.		Maximum operating pressure		Minimum burst pressure		Minimum bend radius		Vacuum service		Weight	
	DN	mm	in	mm	in	bar	psi	bar	psi	mm	in	kPa	in/Hg	kg/m	lbs/ft
2651-4	5	4,8	0.19	13,2	0.52	210,0	3000	840,0	12000	76,2	3.00	94,8	28	0,19	0.13
2651-5	6	6,4	0.25	14,7	0.58	210,0	3000	840,0	12000	85,9	3.38	94,8	28	0,24	0.16
2651-6	8	7,9	0.31	17,3	0.68	157,0	2250	630,0	9000	101,6	4.00	94,8	28	0,34	0.23
2651-8	10	10,4	0.41	19,1	0.75	140,0	2000	560,0	8000	117,3	4.62	94,8	28	0,38	0.26
2651-10	13	12,7	0.50	23,4	0.92	122,0	1750	490,0	7000	139,7	5.50	94,8	28	0,55	0.37
2651-12	16	16,0	0.63	27,4	1.08	105,0	1500	420,0	6000	165,1	6.50	94,8	28	0,68	0.46
2651-16	22	22,4	0.88	31,2	1.23	56,0	800	224,0	3200	187,5	7.38	67,7	20 †	0,65	0.44
2651-20	28	28,4	1.12	38,1	1.50	43,0	625	175,0	2500	228,6	9.00	67,7	20 †	0,77	0.52
2651-24	35	35,1	1.38	44,5	1.75	35,0	500	140,0	2000	266,7	10.50	50,8	15 †	0,99	0.67
2651-32	46	46,0	1.81	56,4	2.22	24,0	350	98,0	1400	336,6	13.25	37,3	11 †	1,39	0.94
2651-40	60	60,1	2.38	73,2	2.88	24,0	350	98,0	1400	609,6	24.00	37,3	11 †	2,11	1.43

†Maximum negative pressures shown for -16 and larger are suitable for hose which has suffered no external damage or kinking. If greater negative pressures are required for -16 and larger hoses, the use of an internal support coil is recommended.

Construction

Tube: Synthetic rubber

Reinforcement: Textile inner braid, single wire braid, textile outer braid

Cover: Synthetic rubber

Operating parameters

-40°C to +100°C
(-40°F to +212°F)

Air not to exceed
250 psi or +71°C (+160°F)

Application

- Hydraulics, gasoline, fuel and lubricating oils, air and water

For more information on agency listings, specific fluid applications and high temperature ratings see section A.

Fitting reference	Page
Reusable	
SAE 100R5 style	I-4-16

Industrial hose

Air and multipurpose hose	D-2	Oil and gas exploration	D-7
Chemical hose	D-3	Petroleum	D-7
Food and beverage	D-4	Specialty	D-8
Liquefied petroleum gas	D-5	Steam	D-9
Material handling	D-6	Water	D-10

D

For additional product information please reference Eaton's Industrial Hose Catalog:
North America E-HOOV-MC003-E, and Global E-HOIN-SS001-E.



Industrial hose

D

Air and multipurpose

High pressure

H6009 **BULLDOG GOLD**



EHA500 **High pressure air**

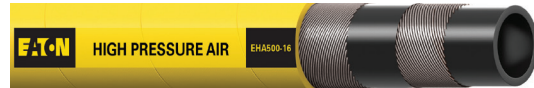

Low pressure

H9949 **Shock-Safe**



H1776 & H1777 **Perfection 300**



H201 **Easy Couple**



H275 **Polyforce II**



H1812 **Industrial Air / Water**

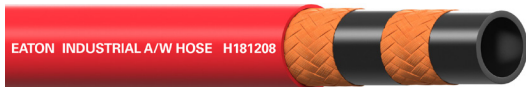

General air and water

H1981 & H1982 **Marathoner – Non-conductive**

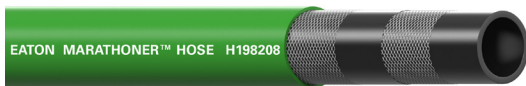

H0106 **Bosflex A/W**



H0105 **Bosflex A/W**



Specialty

EHW028 **Heavy duty MSHA mine spray**



For additional product information please reference Eaton's Industrial Hose Catalog: North America E-HOOV-MC003-E, and Global E-HOIN-SS001-E

Chemical

Suction and discharge

H0523 CHEMCAT petrochemical



H0599 CHEMCAT corrugated petrochemical



H0060 ARMORCAT corrugated petrochemical



H0378 Green cross-linked



H0345 TIGER chemical suction and discharge



Discharge

H0346 LEOPARD chemical discharge



Specialty

H1941 & H1942 NYALL



For additional product information please reference Eaton's Industrial Hose Catalog: North America E-HOOV-MC003-E, and Global E-HOIN-SS001-E

Industrial hose

D

Food and beverage

Food suction and discharge

H0350 LION Food transfer



Beverage suction and discharge

H285 CLEARFORCE-R



PT200 CLEARFORCE-NR



Cleaning service

H1066 Creamery/Packing washdown

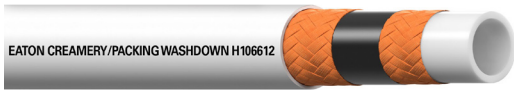

H9673 Washdown 1250

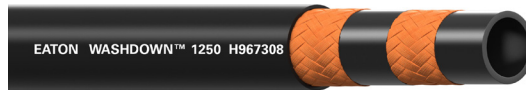

H9610 Washdown 1000



For additional product information please reference Eaton's Industrial Hose Catalog: North America E-HOOV-MC003-E, and Global E-HOIN-SS001-E

Liquefied petroleum gas

LPG

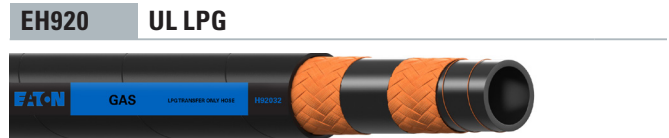
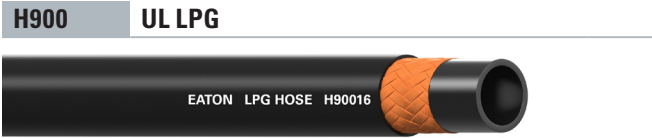

For additional product information please reference
Eaton's Industrial Hose Catalog: North America
E-HOOV-MC003-E, and Global E-HOIN-SS001-E

Industrial hose

D

Material handling

Dry material

H0347 WILDCAT dry material



H0319 WILDCAT soft wall dry material



H0521 WILDCAT heavy duty dry material



H0349 WILDCAT hot air transfer



Sandblast

H0034 WILDCAT Sandblast



Concrete Pumping

EHK006 MARAUDER Concrete pumping



EHK007 MARAUDER HD Concrete pumping



For additional product information please reference Eaton's Industrial Hose Catalog: North America E-HOOV-MC003-E, and Global E-HOIN-SS001-E

Oil and gas exploration

Frac and well service

H0377 Kelly power drilling



Suction and discharge

EHP009 Oilfield vacuum



Petroleum

Oil suction and discharge

H6009 BULLDOG GOLD



H1193 ROYALFLEX petroleum



H0363 PUMA suction and discharge



EHP150 Petroleum/Oil suction and discharge



Discharge

H901 Boston Bulldog fuel oil delivery



For additional product information please reference Eaton's Industrial Hose Catalog: North America E-HOOV-MC003-E, and Global E-HOIN-SS001-E

Industrial hose

D

Specialty

Steel mill

EHN004 Steel mill heavy duty white cooling water transfer

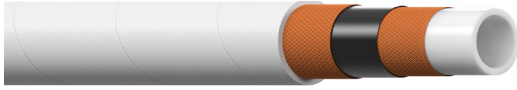

Road construction

H0372 BLACKCAT hot tar and asphalt



H0616 BLACKCAT corrugated hot tar and asphalt



H9603 Hot tar pumping



Specialized

H9690 Hydrocarbon drain



H8811 Nitrogen



For additional product information please reference Eaton's Industrial Hose Catalog: North America E-HOOV-MC003-E, and Global E-HOIN-SS001-E

Steam

Steam hose

EH084 Steam Slayer



H9568 Concord 250 steam



H0084 Concord standard



H9690 Hydrocarbon drain



For additional product information please reference Eaton's Industrial Hose Catalog: North America E-HOOV-MC003-E, and Global E-HOIN-SS001-E

Industrial hose

D

Water

Suction and discharge

H1196 Royalflex water



H0364 OTTER water suction and discharge



EHW150 Water suction and discharge



Discharge

EHW029 OTTER layflat water discharge



Specialty

EHW028 Heavy duty MSHA mine spray



H345 Pressure washer



Sewer cleaning

FC701 Eaton GATOR hose



Sewer hoses are only sold as complete assemblies.

FC702 Eaton GATOR hose



Sewer hoses are only sold as complete assemblies.

For additional product information please reference Eaton's Industrial Hose Catalog: North America E-HOOV-MC003-E, and Global E-HOIN-SS001-E

Air conditioning and refrigeration hose

GH001	E-3	FC800	E-5
FC802	E-4	FC555	E-6

E



Air conditioning and refrigeration

E

GH001 EverCool A/C and refrigeration E-3



FC802 A/C and refrigeration E-4



FC800 EverCool A/C and refrigeration E-5



FC555 Multi-refrigerant hose E-6



GH001

EverCool A/C and refrigeration

Exceeds: SAE J2064 Type E, Class 1

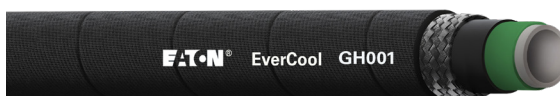

# Part number	Hose I.D.		Hose O.D.		Maximum operating pressure		Minimum burst pressure		Minimum bend radius		Weight		Vacuum service	
	DN	mm in	mm in	bar psi	bar psi	mm in	kg/m lbs/ft	kPa in						
	GH001-4	5	4,8 0.19	11,6 0.46	35 500	140 2000	38,1 1.50	0,100 0.07	94,8 28					
GH001-6	8	7,9 0.31	14,7 0.58	35 500	140 2000	50,0 2.00	0,135 0.09	94,8 28						
GH001-8	10	10,3 0.41	17,8 0.70	35 500	140 2000	63,0 2.50	0,177 0.12	94,8 28						
GH001-10	12	12,7 0.50	19,8 0.78	35 500	140 2000	76,2 3.00	0,223 0.15	94,8 28						
GH001-12	16	15,9 0.63	24,9 0.98	35 500	140 2000	101,6 4.00	0,269 0.18	94,8 28						
GH001-16	19	22,4 0.88	31,2 1.23	35 500	140 2000	127,0 7.00	0,430 0.22	94,8 28						

Construction

Tube: New dual extrusion technology polyamide Type E veneer

Reinforcement: Polyester braid

Cover: Blended EPDM

Operating parameters

-40°C to +140°C
(-40°F to +284°F)

R1234yf effusion
<1kg/m²/yr at 80°C

R134a effusion
<1.5kg/m²/yr at 80°C

Oils
POE, PAG, Mineral oil, Alkybenzene

Moisture ingress
Class I

Benefits

- Extremely low permeation
- Excellent heat resistance offering a higher functional temperature range than SAE J2064 Type C or E hoses
- Ozone and UV resistant
- Easy to install – significant reduction in potential hose damage. GH001 has maximum kink resistance, temperature resistance
- SAE J2064 Type E veneer tube offers excellent oil and refrigerant compatibility

Application

- A/C systems for truck, bus, agriculture, construction equipment and refrigeration systems

For more information refer to E-HOAC-BB001-E.

Fitting reference

Factory Crimp – contact Eaton technical support.

E-Z Clip fittings – refer to A-HOAC-MC001-E, A/C and Refrigeration hose and fittings.

FC802

Multi-refrigerant A/C and refrigeration hose

Meets: SAE J51



# Part number	Hose I.D.		Hose O.D.		Maximum operating pressure		Minimum burst pressure		Minimum bend radius		Weight		Vacuum service	
	DN	mm in	mm in	bar psi	bar psi	mm in	kg/m lbs/ft	kPa in						
FC802-04	4	5,1 0.20	13,2 0.52	35 500	175 2500	50,8 2.0	0,16 0.11	94,8 28						
FC802-06	6	8,38 0.33	17,3 0.68	35 500	175 2500	63,5 2.5	0,24 0.16	94,8 28						
FC802-08	8	10,67 0.42	19,6 0.77	35 500	175 2500	76,2 3.0	0,27 0.18	94,8 28						
FC802-10	10	13,2 0.52	23,4 0.92	35 500	175 2500	88,9 3.5	0,42 0.28	94,8 28						
FC802-12	12	16,51 0.65	27,4 1.08	35 500	175 2500	114,3 4.5	0,51 0.34	94,8 28						

Construction

Tube: Polyamide veneer

Reinforcement: Single polyester braid

Cover: Bromobutyl

Operating parameters

-40°C to +250°C
(-40°F to +121°F)

HFC 134a effusion

.25 lbs/ft²/yr at 176°F
(1.21 kg/m²/yr at 80°C)

Moisture ingress

.08 gm/in²/yr (.013/cm²/yr)
(Class1)

Benefits

- Excellent flexibility and heat resistance
- Excellent noise and kink resistance
- Ease of installation and routing

Application

- Mobile A/C
- Stationary A/C system and refrigeration

For more information refer to the E-Z Clip A-HOAC-MC001-E A/C and Refrigeration hose and fittings.

Fitting reference	Page
100R5 Fitting	I-4-16

FC800

EverCool A/C and refrigeration

Meets: SAE J2064



# Part number	Hose I.D.			Hose O.D.		Maximum operating pressure		Minimum burst pressure		Minimum bend radius		Weight		Vacuum service	
	DN	mm	in	mm	in	bar	psi	bar	psi	mm	in	kg/m	lbs/ft	kPa	in
FC800-12	12	16,4	0.65	27,2	1.07	35	500	140	2000	70	3.0	0,67	0.45	94,8	28
FC800-16	16	22,8	0.90	31,5	1.24	35	500	140	2000	80	3.5	0,71	0.48	94,8	28
FC800-20	20	29,3	1.15	38,6	1.52	35	500	140	2000	100	4.0	0,92	0.62	94,8	28
FC800-24	24	35,5	1.40	45,6	1.80	35	500	140	2000	160	6.5	1,16	0.78	94,8	28

Construction

Tube: Chloroprene (CR)

Barrier Layer:
Polyamide (PA)

Reinforcement:
1 wire braid

Cover: EPDM

Operating parameters

-40°C to +125°C
(-40°F to +257°F)

Permeation rate

<1,0 kg/m²/year
(for R134a at 80°C)

Moisture ingress

<0.039 g/cm²/year
according to SAE J2064,
Class 1

Refrigerant use

R134a, R407C, HF1234yf.
Additional refrigerants and
refrigerant oils upon request.

Benefits

- FC800 EverCool exceeds the requirements of the SAE J2064
- FC800 has an excellent bend radius, virtually 1/2 of the radius of comparable large bore hoses

Applications

- Metro, large bus and rail
- Overhead cranes and stationary equipment

For more information refer to A-HOAC-MR003-E, EverCool New Large Bore A/C Hose.

Fitting reference

Refer to A-HOAC-MR003-E catalog FC800 EverCool New Large Bore A/C Hose.

FC555

Multi-refrigerant A/C and refrigeration hose

Meets: SAE J2064



# Part number	Hose I.D.			Hose O.D.		Maximum operating pressure		Minimum burst pressure		Minimum bend radius		Weight		Vacuum service	
	DN	mm	in	mm	in	bar	psi	bar	psi	mm	in	kg/m	lbs/ft	kPa	in
FC555-12	12	15.9	0.62	28,5	1.2	35	500	175	2500	63.5	2.50	0,30	0.20	94,8	28
FC555-16	16	22.4	0.88	35,1	1.38	35	500	175	2500	76.2	3.00	0,40	0.27	94,8	28
FC555-20	25	28.4	1.2	41,9	1.65	35	500	175	2500	101.6	4.00	0,49	0.33	94,8	28

Construction

Tube: Corrugated polyamide

Reinforcement:
Polyester braid

Cover: Abrasion resistant polyester braided cover

Operating parameters

-40°C to +125°C
(-40°F to +257°F)

R134a effusion
.97 kg/m²/yr at 80°C
(.20 lbs/ft²/yr at 180°F)

Moisture ingress ion
Class I

Features

- Machined hose nipple with two o-rings
- O-ring material - HNBR
- One-piece fitting design, factory crimp
- Abrasion resistant

Benefits

- Optimum sealing at the hose nipple interface
- Multi-refrigerant compatible
- Significantly exceeds industry standards for refrigerant loss
- Simplifies inventory

Applications

- Large and medium buses
- Rail
- Applications where extreme flexibility is required for a large-size hose

For more information refer to A-HOAC-MR001-E Multi-Refrigerant Hose and Fittings.

Fitting reference

Factory crimp fittings available. For more information, refer to A-HOAC-MR001-E, FC800 EverCool New Large Bore A/C Hose.

Transportation

Synflex coils, air brake and diesel fuel tubing

15CA Eclipse	F-5
3SCE Eclipse	F-5
4245 Eclipse	F-6
4247 Solstice	F-7
3270 Eclipse	F-8
4294 Synflex	F-9
4297 Synflex	F-10
4KGEN Synflex	F-11

Fuel line hose

H057	F-12
35FH	F-13

Air brake hose

EC038	F-14
2570	F-14
2550/2554	F-15
1531	F-15

Silicone hose

EH225	F-16
EH226	F-17
EH227	F-18

Diesel and biodiesel hose

GH100 ESP	F-19
GH101 ESP	F-19

Engine and air brake hose

FC355	F-20
FC350	F-21
FC300	F-22

High temperature engine, fuel and oil hose

FC650	F-23
FC699	F-23
FC234	F-24

LPG hose

FC321	F-25
CR170	F-26

CNG hose – High and low pressure

35NG	F-27
NG-TW	F-28

F



F Synflex coils, air brake tubing and diesel fuel tubing

Air brake coils

15CA Eclipse air brake coil **F-5**



3SCE Eclipse fifth-wheel slider coil **F-5**



Air brake tubing

4245 Eclipse truck air brake, Type A **F-6**



4247 Solstice truck air brake, Type A **F-7**



3270 Eclipse truck air brake, Type B **F-8**



Diesel fuel tubing

4297 High-flex diesel fuel tubing **F-10**

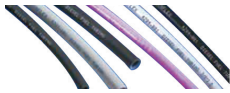

4294 Low-flex diesel fuel tubing **F-9**

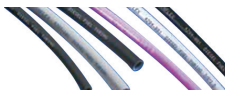

4KGEN Diesel fuel kits **F-11**



Truck and engine maintenance

Fuel line hose

H057 Fuel line hose **F-12**



35FH Fuel line hose **F-13**



Air brake hose

EC038 Air brake hose **F-14**



2570 Air brake hose **F-14**



2550/2554 Air brake hose **F-15**



1531 Railroad air brake hose **F-15**



Silicone hose

EH225 Heater hose **F-16**



EH226 Coolant hose **F-17**



EH227 4-ply Turbo hose **F-18**



Diesel and biodiesel hose

GH100 ESP Braided - diesel and biodiesel **F-19**



GH101 ESP CPE rubber - diesel and biodiesel **F-19**



Truck and engine maintenance

Engine and air brake hose

FC355 Engine and air brake hose **F-20**



FC350 Engine and air brake hose **F-21**



FC300 Textile and wire braid **F-22**



High temperature fuel and oil hose

FC650 High temperature fuel and oil hose **F-23**

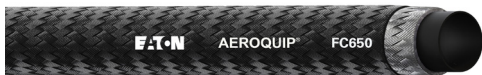

FC699 High temperature fuel and oil hose **F-23**



FC234 High temperature fuel and oil hose **F-24**



LPG hose

FC321 UL Listing MH6044 hose **F-25**



CR170 CGA Type III hose **F-26**



CNG hose, high and low pressure

35NG Synflex High pressure CNG hose **F-27**



NG-TW Low pressure CNG hose **F-28**

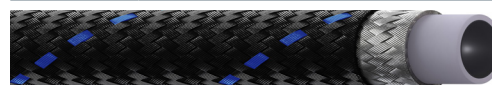

15CA Eclipse Air brake coil

Meets: SAE J844 Type B, DOT-FMVSS 106, (49 FR571.106)



# Part number	Description	Valve pigtail length		Male ends				Working Length	
		mm	in	Valve		Gladhand		m	ft
15CA12-12	15' WL abt coil set w/ 12" pigtails	304,8	12.00	12,7	0.50	12,7	0.50	4,6	15.00
15CA48-12	15' WL abt coil set w/ 48" pigtails	1.219,2	48.00	12,7	0.50	12,7	0.50	4,6	15.00
15CAR12-12	15' WL single, red abt coil w/ 12" pigtails	304,8	12.00	12,7	0.50	12,7	0.50	4,6	15.00
15CAB12-12	15' WL single, blue abt coil w/ 12" pigtails	304,8	12.00	12,7	0.50	12,7	0.50	4,6	15.00
15CAR48-12	15' WL single, red abt coil w/ 48" pigtails	1.219,2	48.00	12,7	0.50	12,7	0.50	4,6	15.00
15CAB48-12	15' WL single, blue abt coil w/ 48" pigtails	1.219,2	48.00	12,7	0.50	12,7	0.50	4,6	15.00
12CA12-12	12' WL abt coils set w/ 12" pigtails	304,8	12.00	12,7	0.50	12,7	0.50	3,7	17.00
12CAR12-12	12' WL single, red abt coil w/ 12" pigtails	304,8	12.00	12,7	0.50	12,7	0.50	3,7	17.00
12CAB12-12	12' WL single, blue abt coil w/ 12" pigtails	304,8	12.00	12,7	0.50	12,7	0.50	3,7	17.00
20CA12-12	20' WL abt coil set w/ 12" pigtails	304,8	12.00	12,7	0.50	12,7	0.50	6,1	20.00

Construction

Tube: Synflex® Eclipse air brake tubing, 100% polyamide

Reinforcement: Polyester yarn

Brass end fittings with corrosion resistant spring guards

Operating parameters

-54°C to +93°C
(-65°F to +200°F)

Application

- Articulating connections for air brake line systems (connections between towed and towing motor vehicle)
- Tractor-to-trailer air connections used in extremely low temperatures

Features

- Superior abrasion resistance
- Excellent return and coil memory
- Enhanced flexibility and extension
- Brass end fittings with corrosion resistant spring guards

3SCE Eclipse Fifth-wheel slider coil

Meets: SAE J844 Type B, DOT-FMVSS 106, (49 FR571.106)



# Part number	Valve pigtail length		End fitting	Working length		Retracted length	
	mm	in		mm	ft	mm	in
3SCE-0303304-033	88,9	3.50	None	1.371,6	54.00	254,0	10.00
3SCE-0303304-166	88,9	3.50	1/4" male pipe	1.371,6	54.00	254,0	10.00

Construction

Tube: Synflex Eclipse air brake tubing, 100% polyamide

Reinforcement: Polyester yarn

Brass end fittings with corrosion resistant spring guards

Operating parameters

-54°C to +93°C
(-65°F to +200°F)

Application

- Articulating connections for air brake line systems (connections between towed and towing motor vehicle)
- Tractor-to-trailer air connections used in extremely low temperatures

Features

- Superior abrasion resistance
- Excellent return and coil memory
- Enhanced flexibility and extension

Transportation

Synflex Air brake tubing

F

4245 Eclipse

Type A truck air brake tubing

Meets: SAE J844 Type A, SAE J1131, SAE J2494-3, DOT-FMVSS 106



# Part number	Tube size	Tube O.D.		Tube I.D.		Wall thickness		Minimum burst pressure		Minimum bend radius		Weight		Color	Package length*	
		mm	in	mm	in	mm	in	bar	psi	mm	in	kg/100m	lbs/100ft		m	ft
4245-02207	-02	3,2	.125	2,0	0.08	0,6	0.02	69,0	1,000	6,4	0.25	0,5	0.33	Black	3.657,6	12,000
4245-02227	-02	3,2	.125	2,0	0.08	0,6	0.02	69,0	1,000	6,4	0.25	0,5	0.33	Red	3.657,6	12,000
4245-02257	-02	3,2	.125	2,0	0.08	0,6	0.02	69,0	1,000	6,4	0.25	0,5	0.33	Green	3.657,6	12,000
4245-02267	-02	3,2	.125	2,0	0.08	0,6	0.02	69,0	1,000	6,4	0.25	0,5	0.33	Blue	3.657,6	12,000
4245-02506	-02	4,0	.125	2,3	0.09	0,8	0.03	83,0	1,200	12,7	0.50	0,8	0.56	Black	1.828,8	6,000
4245-02526	-02	4,0	.125	2,3	0.09	0,8	0.03	83,0	1,200	12,7	0.50	0,8	0.56	Red	1.828,8	6,000
4245-02546	-02	4,0	.125	2,3	0.09	0,8	0.03	83,0	1,200	12,7	0.50	0,8	0.56	Yellow	1.828,8	6,000
4245-02556	-02	4,0	.125	2,3	0.09	0,8	0.03	83,0	1,200	12,7	0.50	0,8	0.56	Green	1.828,8	6,000
4245-02566	-02	4,0	.125	2,3	0.09	0,8	0.03	83,0	1,200	12,7	0.50	0,8	0.56	Blue	1.828,8	6,000
4245-03306	-03	4,8	.188	3,0	0.12	0,9	0.04	83,0	1,200	19,1	0.75	1,1	0.71	Black	1.828,8	6,000
4245-03326	-03	4,8	.188	3,0	0.12	0,9	0.04	83,0	1,200	19,1	0.75	1,1	0.71	Red	1.828,8	6,000
4245-03356	-03	4,8	.188	3,0	0.12	0,9	0.04	83,0	1,200	19,1	0.75	1,1	0.71	Green	1.828,8	6,000

*Master pack quantity part numbers listed. For master pack configuration information refer to chart below:

Construction

Tube: 100% polyamide
Reinforcement: Polyester yarn

Operating parameters

-54°C to +93°C
 (-65°F to +200°F)

Application

- Truck air brake systems
- Trailer air brake systems
- Auxiliary air systems
- Formed tubes
- Formed and straight air brake harness assemblies

Not for use with fuel

Features

- Superior abrasion resistance
- Ease of cutting
- Enhanced flexibility and extension
- Flow performance
- UV stabilized, thermoformable
- Available in standard and custom colors
- Available in all standard sizes

Fitting reference

Brass

For more information on brass fittings see Eaton Brass Products Master Catalog E-BRFI-MC001-E.

Master pack configuration

Part number	Hose I.D.		Package type	Package count	Package Length	
	mm	in			mm	ft
4245-02	2,0	0.08	Reel	6	609,6	2,000
4245-02	2,3	0.09	Reel	6	304,8	1,000
4245-03	3,0	0.12	Reel	6	304,8	1,000
4247-04	4,3	0.17	Reel	6	304,8	1,000
4245-05	5,9	0.23	Reel	6	152,4	500

Note: Eaton offers 100, 500, and 1,000 ft short roll packages for the 4245 and 4247 tubing. Please see Eaton literature E-PNOV-MS004-E Short Roll Reference Guide, for details or contact your Eaton sales or customer service representative.



4247 Solstice Type A truck air brake tubing

Meets: SAE J844 Type A, SAE J1131, SAE J2494-3, DOT-FMVSS 106

# Part number	Tube size	Tube O.D.		Tube I.D.		Wall thickness		Minimum burst pressure		Minimum bend radius		Weight		Color	Package length*	
		mm	in	mm	in	mm	in	bar	psi	mm	in	kg/100m	lbs/100ft		m	ft
4247-04106	-04	6,4	.25	4,3	0.17	1,0	0.04	83,0	1,200	25,4	1.00	2,2	1.50	Black	1.828,8	6,000
4247-04126	-04	6,4	.25	4,3	0.17	1,0	0.04	83,0	1,200	25,4	1.00	2,2	1.50	Red	1.828,8	6,000
4247-04136	-04	6,4	.25	4,3	0.17	1,0	0.04	83,0	1,200	25,4	1.00	2,2	1.50	Orange	1.828,8	6,000
4247-04146	-04	6,4	.25	4,3	0.17	1,0	0.04	83,0	1,200	25,4	1.00	2,2	1.50	Yellow	1.828,8	6,000
4247-04156	-04	6,4	.25	4,3	0.17	1,0	0.04	83,0	1,200	25,4	1.00	2,2	1.50	Green	1.828,8	6,000
4247-04166	-04	6,4	.25	4,3	0.17	1,0	0.04	83,0	1,200	25,4	1.00	2,2	1.50	Blue	1.828,8	6,000
4245-05204	-05	8,0	.312	5,9	0.23	1,0	0.04	69,0	1,000	28,6	1.13	2,3	1.54	Black	914,4	3,000
4245-05224	-05	8,0	.312	5,9	0.23	1,0	0.04	69,0	1,000	28,6	1.13	2,3	1.54	Red	914,4	3,000
4245-05244	-05	8,0	.312	5,9	0.23	1,0	0.04	69,0	1,000	28,6	1.13	2,3	1.54	Yellow	914,4	3,000
4245-05254	-05	8,0	.312	5,9	0.23	1,0	0.04	69,0	1,000	28,6	1.13	2,3	1.54	Green	914,4	3,000
4245-05264	-05	8,0	.312	5,9	0.23	1,0	0.04	69,0	1,000	28,6	1.13	2,3	1.54	Blue	914,4	3,000

*Master pack quantity part numbers listed. For master pack configuration information refer to chart below:

Construction

Tube: 100% polyamide

Reinforcement: Polyester yarn

Operating parameters

-54°C to +93°C
(-65°F to +200°F)

Application

- Truck air brake systems
- Trailer air brake systems
- Auxiliary air systems
- Formed tubes
- Formed and straight air brake harness assemblies

Not for use with fuel

Features

- Superior abrasion resistance
- Ease of cutting
- Enhanced flexibility and extension
- Flow performance
- UV stabilized, thermoformable
- Available in standard and custom colors
- Available in all standard sizes

Fitting reference

Brass

For more information on brass fittings see Eaton Brass Products Master Catalog E-BRFI-MC001-E.

Master pack configuration

Part number	Hose I.D.		Package type	Package count	Package Length	
	mm	in			mm	ft
4245-02	2,0	0.08	Reel	6	609,6	2,000
4245-02	2,3	0.09	Reel	6	304,8	1,000
4245-03	3,0	0.12	Reel	6	304,8	1,000
4247-04	4,3	0.17	Reel	6	304,8	1,000
4245-05	5,9	0.23	Reel	6	152,4	500

Note: Eaton offers 100, 500, and 1,000 ft short roll packages for the 4245 and 4247 tubing. Please see Eaton literature E-PNOV-MS004-E Short Roll Reference Guide, for details or contact your Eaton sales or customer service representative.

Transportation

Synflex Air brake tubing

F

3270 Eclipse

Type B truck air brake tubing

Meets: SAE J844 Type B, SAE J1131, SAE J2494-3, DOT-FMVSS 106



# Part number	Tube size	Tube O.D.		Tube I.D.		Wall thickness		Minimum burst pressure		Minimum bend radius		Weight		Color	Package length*	
		mm	in	mm	in	mm	in	bar	psi	mm	in	kg/100m	lbs/100ft		m	ft
3270-06104	-06	9,5	.375	6,4	0.25	1,6	0.06	96,5	1,400	38,1	1.50	4,2	2.80	Black	914,4	3,000
3270-06124	-06	9,5	.375	6,4	0.25	1,6	0.06	96,5	1,400	38,1	1.50	4,2	2.80	Red	914,4	3,000
3270-06134	-06	9,5	.375	6,4	0.25	1,6	0.06	96,5	1,400	38,1	1.50	4,2	2.80	Orange	914,4	3,000
3270-06144	-06	9,5	.375	6,4	0.25	1,6	0.06	96,5	1,400	38,1	1.50	4,2	2.80	Yellow	914,4	3,000
3270-06154	-06	9,5	.375	6,4	0.25	1,6	0.06	96,5	1,400	38,1	1.50	4,2	2.80	Green	914,4	3,000
3270-06164	-06	9,5	.375	6,4	0.25	1,6	0.06	96,5	1,400	38,1	1.50	4,2	2.80	Blue	914,4	3,000
3270-08104	-08	12,7	.50	9,6	0.38	1,6	0.06	65,5	950	50,8	2.00	5,8	3.80	Black	457,2	1,500
3270-08124	-08	12,7	.50	9,6	0.38	1,6	0.06	65,5	950	50,8	2.00	5,8	3.80	Red	457,2	1,500
3270-08134	-08	12,7	.50	9,6	0.38	1,6	0.06	65,5	950	50,8	2.00	5,8	3.80	Orange	457,2	1,500
3270-08144	-08	12,7	.50	9,6	0.38	1,6	0.06	65,5	950	50,8	2.00	5,8	3.80	Yellow	457,2	1,500
3270-08154	-08	12,7	.50	9,6	0.38	1,6	0.06	65,5	950	50,8	2.00	5,8	3.80	Green	457,2	1,500
3270-08164	-08	12,7	.50	9,6	0.38	1,6	0.06	65,5	950	50,8	2.00	5,8	3.80	Blue	457,2	1,500
3270-10103	-10	15,9	.625	11,2	0.44	2,3	0.09	62,1	900	63,5	2.50	10,4	7.00	Black	228,6	750
3270-10123	-10	15,9	.625	11,2	0.44	2,3	0.09	62,1	900	63,5	2.50	10,4	7.00	Red	228,6	750
3270-10133	-10	15,9	.625	11,2	0.44	2,3	0.09	62,1	900	63,5	2.50	10,4	7.00	Orange	228,6	750
3270-10143	-10	15,9	.625	11,2	0.44	2,3	0.09	62,1	900	63,5	2.50	10,4	7.00	Yellow	228,6	750
3270-10153	-10	15,9	.625	11,2	0.44	2,3	0.09	62,1	900	63,5	2.50	10,4	7.00	Green	228,6	750
3270-10163	-10	15,9	.625	11,2	0.44	2,3	0.09	62,1	900	63,5	2.50	10,4	7.00	Blue	228,6	750
3270-12103	-12	19,1	.75	14,4	0.57	2,3	0.09	55,2	800	76,2	3.00	12,8	8.60	Black	228,6	750
3270-12123	-12	19,1	.75	14,4	0.57	2,3	0.09	55,2	800	76,2	3.00	12,8	8.60	Red	228,6	750
3270-12133	-12	19,1	.75	14,4	0.57	2,3	0.09	55,2	800	76,2	3.00	12,8	8.60	Orange	228,6	750
3270-12153	-12	19,1	.75	14,4	0.57	2,3	0.09	55,2	800	76,2	3.00	12,8	8.60	Green	228,6	750
3270-12163	-12	19,1	.75	14,4	0.57	2,3	0.09	55,2	800	76,2	3.00	12,8	8.60	Blue	228,6	750

*Master pack quantity part numbers listed. For master pack configuration information refer to chart below.

Construction

Tube: 100% polyamide formed tubes

Reinforcement: Polyester yarn

Operating parameters

-54°C to +93°C
(-65°F to +200°F)

Application

- Truck air brake systems
- Trailer air brake systems
- Auxiliary air systems

Not for use with fuel

Features

- Superior abrasion resistance
- Ease of cutting
- Enhanced flexibility and extension
- Flow performance
- UV stabilized, thermoformable
- Formed and straight air brake harness assemblies
- Available in standard and custom colors
- Available in all standard sizes

Master pack configuration

Part no	Hose I.D.		Package type	Package count	Package Length	
	mm	in			mm	ft
3270-06	6,4	0.25	Reel	6	152,4	500
3270-08	9,6	0.38	Reel	3	152,4	500
3270-10	11,2	0.44	Reel	3	76,2	250
3270-12	14,4	0.57	Reel	3	76,2	250

Note: Eaton offers 100, 500, and 1,000 ft short roll packages for the 3270 tube. Please see Eaton literature E-PNOV-MS004-E for details or contact your Eaton sales or customer service representative.

4294 Synflex Low-flex diesel fuel tubing



F

# Part number	Tube size	Tube I.D.		Tube O.D.		Wall thickness		Maximum operating pressure		Minimum burst pressure		Minimum bend radius		Weight		Color	Package length*	
		DN	mm in	mm in	mm in	mm in	bar psi	bar psi	mm in	mm in	kg/100m	lbs/100ft	m	ft				
4294-06	-06	10	6,4 0.25	9,9 0.40	1,8 0.07	5 75	34,5 500	28,7 1.13	1,4 3.00	Black Aluminum	30,5 100							
4294-07	-07	11	7,6 0.30	11,1 0.44	1,8 0.07	5 75	34,5 500	31,8 1.25	1,5 3.40	Black Aluminum	30,5 100							
4294-08	-08	12	9,5 0.38	13,3 0.53	1,9 0.08	5 75	34,5 500	76,3 3.00	2,0 4.50	Black Aluminum Purple	30,5 100							
4294-10	-10	16	12,1 0.48	17,2 0.68	2,5 0.10	5 75	34,5 500	88,9 3.50	3,3 7.30	Black Aluminum	30,5 100							

*Random length box packaged part numbers listed. Other packaging options available. See Customer Connect or contact your Eaton customer service representative.

Construction

Tube: Nylon 12

Cover: Thermoplastic

Operating parameters

-40°C to +93°C
(-40°F to +200°F)

Standard Compliance

Portions of: SAE J844, J1131, J1394

ASTM D471, 0624, 0638, D648, 0709, 0746, 0742, 02240

Application

- Designed specifically for diesel fuel applications
- Transportation – trucks, buses and off-highway vehicles, construction machinery and equipment
- Agriculture machinery and equipment
- Marine, boats and yachts
- Diesel engines and generators

Features

- Lightweight fuel tube assemblies can weigh up to 66% less
- Well suited for formed fuel harness applications
- Multiple color options
- Excellent cost/value

Qualified fittings

Contact your Eaton account sales manager for composite and metal fitting options.

For more information refer to the Synflex Thermoplastic Hose and Fittings E-HOOV-MC001-E.

Transportation

Synflex Diesel fuel tubing

F

4297 Synflex

High-flex diesel fuel tubing

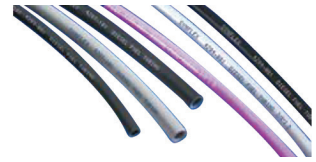

# Part number	Hose size	Tube I.D.		Tube O.D.		Wall thickness		Maximum operating pressure		Minimum burst pressure		Minimum bend radius		Weight		Color	Package length*	
		DN	mm in	mm in	mm in	mm in	bar psi	bar psi	mm in	mm in	kg/100m	lbs/100ft	m	ft				
4297-M10	M10	10	6,0 0.24	9,6 0.39	1,9 0.08	4 50	34,0 500	28,7 1.13	1,4 3.10	Black	30,5 100							
4297-06	-06	10	6,4 0.25	9,9 0.39	1,9 0.07	4 50	34,0 500	28,7 1.13	1,4 3.10	Black Aluminum	30,5 100							
4297-07	-07	11	7,6 0.30	11,1 0.44	1,9 0.07	4 50	34,0 500	31,8 1.25	1,6 3.50	Black Aluminum	30,5 100							
4297-M12	M12	12	8,0 0.31	11,8 0.48	1,9 0.08	4 50	34,0 500	44,5 1.75	1,7 3.70	Black	30,5 100							
4297-08	-08	12	9,5 0.38	13,3 0.53	1,9 0.07	4 50	34,0 500	76,3 3.00	2,2 4.90	Black Aluminum	30,5 100							
4297-10	-10	16	12,1 0.48	17,2 0.68	2,5 0.10	4 50	34,0 500	88,9 3.50	3,4 7.40	Black Aluminum	30,5 100							

*Random length box packaged part numbers listed. Other packaging options available. See Customer Connect or contact your Eaton customer service representative.

Construction

Tube: Nylon 11

Cover: Thermoplastic elastomer

Operating parameters

-45°C to +122°C
(-50°F to +250°F)

Standard Compliance

Portions of: SAE J844, J1131, J1394

ASTM D471, 0624, 0638, D648, 0709, 0746, 0742, 02240

Application

- Formed or unformed harnesses
- Transportation – trucks, buses and off-highway vehicles
- Construction machinery and equipment
- Agriculture machinery and equipment
- Marine, boats and yachts
- Diesel engines and generators

Features

- Excellent flexibility
- Well suited for individual line installation
- Multiple colors
- Designed specifically for diesel fuel applications
- Lightweight fuel tube assemblies can weigh up to 66% less
- Excellent cost/value

Qualified fittings

Contact your Eaton account sales manager for composite and metal fitting options.

For more information refer to the Synflex Thermoplastic Hose and Fittings E-HOOV-MC001-E.

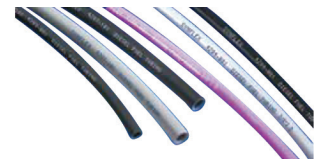

4KGEN Synflex Diesel fuel kits

Specifically designed for modification or repair of OEM fuel systems that use Synflex 4294 or 4297 series fuel tubing.

4KGEN-08-001 Fuel tubing extension kit

Part number	Hose size	DN	Description	Qty	Unit of measure
4408-08710*	-08	12	Plastic female fitting	4	Pieces
4408-08610*	-08	12	Plastic 90° fitting	2	Pieces
4408-08310*	-08	12	Plastic straight fitting	2	Pieces
4294-0810K	-08	12	Black fuel tubing	25	Feet
4294-081FK	-08	12	Silver fuel tubing	25	Feet

* MTO

4KGEN-10-001 Fuel tubing extension kit

Part number	Hose size	DN	Description	Qty	Unit of measure
4408-10710*	-10	16	Brass female fitting	4	Pieces
4408-10610	-10	16	Plastic 90° fitting	2	Pieces
4408-10310*	-10	16	Plastic straight fitting	2	Pieces
4297-101FX-001	-10	16	Silver fuel tubing	25	Feet

* MTO

Kit content

- OEM male, female, straight and 90 degree barbed fittings
- Synflex 4294 or 4297 series tubing

Application

- Transportation – trucks, buses, off-highway vehicles
- Construction machinery and equipment
- Agriculture machinery and equipment
- Diesel engines and parts

Features

- Synflex 4KGEN kits can be used to modify tank locations, routings, and repair fuel systems in these and many other applications where diesel fuel is used
- Utilize OEM barbed end fittings to maintain o-ring sealing end connection of the original OEM fuel system
- OEM colors available to maintain the same OEM color code integrity

For more information refer to the Synflex Thermoplastic Hose and Fittings E-HOOV-MC001-E.

Transportation

Truck and engine maintenance - Fuel line hose

F

H057

Fuel line hose

Exceeds: SAE 30R7



# Part number	Hose I.D.		Hose O.D.		Maximum operating pressure		Minimum burst pressure		Minimum bend radius		Vacuum service		Weight	
	mm	in	mm	in	bar	psi	bar	psi	mm	in	kPa	in	kg/m	lbs/ft
H05703-100R	4,8	0.19	10,3	0.41	3,4	50	17,2	250	50,8	2.00	94,8	28	0,09	0.06
H05704-100R and H05704-250R	6,4	0.25	12,7	0.50	3,4	50	17,2	250	63,5	2.50	94,8	28	0,13	0.09
H05705-100R	7,9	0.31	14,3	0.56	3,4	50	17,2	250	69,8	2.75	94,8	28	0,16	0.11
H05706-50R and H05706-250R	9,5	0.38	15,9	0.63	3,4	50	17,2	250	76,2	3.00	94,8	28	0,18	0.12

Construction

Tube: Nitrile

Reinforcement:

Polyester braid

Cover: Synthetic rubber

Operating parameters

-40°C to +125°C
(-40°F to +275°F)

Application

- Small engine fuel systems for gasoline, ethanol, diesel and up to B20 Biodiesel

For more information on agency listings, specific fluid applications and high temperature ratings see section A.

Fitting reference	Page
SOCKETLESS	I-48-53

Field attachable – Clamp applications, contact Eaton technical support for information.

35FH

Fuel line hose

EPA/CARB, SAE J1527B1-15
Meets: SAE J30R6, SAE J30R9, SAE J30R11



# Part number	Hose I.D.		Hose O.D.		Maximum operating pressure		Minimum burst pressure		Minimum bend radius		Vacuum service		Weight	
	mm	in	mm	in	bar	psi	bar	psi	mm	in	kPa	in	kg/m	lbs/ft
35FH-40203-001	6,35	0.25	12,45	0.49	12,0	175	48,2	700	38,1	1.50	94,8	28	0,124	0.083
35FH-40201-001*	6,35	0.25	12,45	0.49	12,0	175	48,2	700	38,1	1.50	94,8	28	0,124	0.083
35FH-50203-001	7,90	0.31	14,20	0.56	12,0	175	48,2	700	38,1	1.50	94,8	28	0,143	0.096
35FH-50207-001*	7,90	0.31	14,20	0.56	12,0	175	48,2	700	38,1	1.50	94,8	28	0,143	0.096
35FH-60203-001	9,50	0.37	15,90	0.63	12,0	175	48,2	700	38,1	1.50	94,8	28	0,156	0.105
35FH-60206-001*	9,50	0.37	15,90	0.63	12,0	175	48,2	700	38,1	1.50	94,8	28	0,156	0.105

* Retail roll package

Construction

Tube: PVDF

Reinforcement: Polyester

Cover: Black PVC alloy

Operating parameters

-40°C to +71°C
(-40°F to +160°F)

Application

- Small engine, outboard marine and turf care fuel systems for gasoline, diesel and up to B20 Biodiesel, where CARB (EPA certification) is required
- Meets the requirements of the International Marine Certification Institutes Recreational Craft Directive 94/25/EC. Qualified to applicable portions of SAE J1527B1-15, SAE J30R6, R9 and 30R11 specifications

For more information on agency listings, specific fluid applications and high temperature ratings see section A.

Fitting reference	Page
SOCKETLESS	I-48-53

Transportation

Truck and engine maintenance - Air brake hose

F

EC038

Air brake hose

Meets: SAE J1402, DOT/FMVSS 106 Type All



#	Hose I.D.		Hose O.D.		Maximum operating pressure		Minimum burst pressure		Minimum bend radius		Vacuum service		Weight	
	mm	in	mm	in	bar	psi	bar	psi	mm	in	kPa	in	kg/m	lbs/ft
EC03804-250R	6,4	0.25	16,7	0.66	15,5	225	62,1	900	32,0	1.25	94,8	28	0,22	0.15
EC03806-250R	9,5	0.38	19,1	0.75	15,5	225	62,1	900	45,0	1.75	94,8	28	0,31	0.21
EC03808-250R	12,7	0.50	22,2	0.88	15,5	225	62,1	900	51,0	2.00	94,8	28	0,40	0.27

Construction

Tube: Highly engineered EPDM

Reinforcement: Polyester braid

Cover: EPDM

Operating parameters

-40°C to +100°C
(-40°F to +212°F)

Application

- Tractor to trailer lines, axle chamber lines and tractor service lines

For more information on agency listings, specific fluid applications and high temperature ratings see section A.

Fitting reference

For more information refer to E-AROV-TB001-E DOT Air Brake Hose and Brass Crimp and Reusable Fittings

2570

Air brake hose

Meets: SAE J1402, DOT/FMVSS 106 Type All



#	Hose I.D.		Hose O.D.		Maximum operating pressure		Minimum burst pressure		Minimum bend radius		Weight	
	mm	in	mm	in	bar	psi	bar	psi	mm	in	kg/m	lbs/ft
2570-6	9,7	0.38	19,1	0.75	16,0	225	62,0	900	44,5	1.75	0,27	0.18
2570-8	12,7	0.50	22,4	0.88	16,0	225	62,0	900	50,8	2.00	0,34	0.23

Construction

Tube: Synthetic rubber

Reinforcement: Double textile braid

Cover: Synthetic rubber

Operating parameters

-40°C to +100°C
(-40°F to +212°F)

Application

- Tractor to trailer lines, axle chamber lines and tractor service lines

For more information on agency listings, specific fluid applications and high temperature ratings see section A.

Fitting reference

Reusable

Power steering & air brake	I-54-55
----------------------------	---------

Contact Eaton technical support for information on crimp assemblies.

2550/2554

Air brake hose

2550 Meets: SAE J1402, DOT/FMVSS 106 Type AII
2554 Meets: SAE J1402, FMVSS 106



#	Hose I.D.		Hose O.D.		Maximum operating pressure		Minimum burst pressure		Minimum bend radius		Weight	
	mm	in	mm	in	bar	psi	bar	psi	mm	in	kg/m	lbs/ft
2550-6	9,7	0.38	19,1	0.75	16,0	225	62,0	900	44,5	1.75	0,30	0.20
2554-6	9,7	0.38	19,1	0.75	16,0	225	62,0	900	95,3	3.75	0,27	0.18

Construction

Tube: Synthetic rubber
Reinforcement: Double textile braids
Cover: Synthetic rubber

Operating parameters

2550: -40°C to +93°C (-40°F to +200°F)
2554: -54°C to +100°C (-65°F to +212°F)

Application

- Tractor to trailer lines, axle chamber lines and tractor service lines
- 2554:** Conforms to ordinance spec. MIL-H-3992B, Type 1, Class 1

For more information on agency listings, specific fluid applications and high temperature ratings see section A.

Fitting reference	Page
Reusable	
Power steering & air brake	I-54-55

Contact Eaton technical support for information on crimp assemblies.

1531

Railroad air brake hose

Exceeds: AAR-M618



#	Hose I.D.		Hose O.D.		Maximum operating pressure		Minimum burst pressure		Minimum bend radius		Weight	
	mm	in	mm	in	bar	psi	bar	psi	mm	in	kg/m	lbs/ft
1531-10*	12,7	0.50	23,9	0.94	21,0	300	84,0	1200	139,7	5.50	0,57	0.38
1531-12*	16,0	0.63	28,4	1.12	21,0	300	84,0	1200	165,1	6.50	0,71	0.48
1531-16	22,4	0.88	35,1	1.38	21,0	300	84,0	1200	187,5	7.38	1,07	0.72
1531-20	28,7	1.13	41,4	1.63	21,0	300	84,0	1200	241,3	9.50	1,16	0.78
1531A-24	35,1	1.38	47,8	1.88	21,0	300	84,0	1200	266,7	10.50	1,55	1.04

* Single wire braid

Construction

Tube: Synthetic rubber
Reinforcement: Partial textile braid, wire reinforcement
Cover: Synthetic rubber

Operating parameters

-54°C to +100°C (-65°F to +212°F)

Application

- Locomotive air brake lines

For more information on agency listings, specific fluid applications and high temperature ratings see section A.

Fitting reference	Page
Reusable	
Railroad air brake	I-56

Contact Eaton technical support for information on crimp assemblies.

Transportation

Truck and engine maintenance - Silicone hose

F

EH225

Heater hose

Meets: SAE J20 R3 Class A

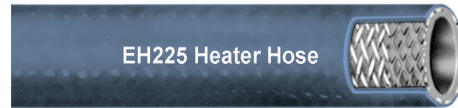

# Part number	Hose I.D.		Hose O.D.		Minimum burst pressure		Length ft/box
	mm	in	mm	in	bar	psi	
	EH22504	6,40	0.25	11,70	0.46	28,0	
EH22505	7,90	0.31	13,20	0.52	21,0	300	25
EH22506	9,70	0.38	16,30	0.64	17,0	250	25
EH22508	12,70	0.50	19,30	0.76	17,0	250	25
EH22510	16,00	0.63	23,60	0.93	17,0	250	25
EH22512	19,10	0.75	27,20	1.07	14,0	200	25
EH22514	22,40	0.88	31,50	1.24	14,0	200	25
EH22516	25,40	1.00	35,10	1.38	12,0	175	25

Construction

Tube: Silicone

Reinforcement: Single ply polyester braid

Cover: Blue

Operating parameters

-54°C to +177°C
(-65°F to +350°F)

Application

- Heater engine

For additional sizes and configurations refer to Eaton bulletin E-HOOV-MC004-E3.

EH226 Coolant hose

Meets: SAE J20 R1 Class A



F

# Part number	Hose I.D.		Hose O.D.		Minimum burst pressure		Length ft/box
	mm	in	mm	in	bar	psi	
EH22605	7,90	0.31	17,50	0.69	74,50	1080	3
EH22606	8,70	0.38	19,10	0.75	73,10	1060	3
EH22608	12,70	0.50	22,10	0.87	60,10	872	3
EH22610	15,70	0.62	25,10	0.99	55,00	797	3
EH22612	19,10	0.75	28,40	1.12	52,70	764	3
EH22614	22,40	0.88	31,80	1.25	50,50	732	3
EH22616	25,40	1.00	34,80	1.37	48,20	699	3
EH22617	26,90	1.06	36,60	1.44	46,70	678	3
EH22618	28,70	1.13	38,10	1.50	45,40	658	3
EH22620	31,80	1.25	41,10	1.62	42,50	617	3
EH22622	35,10	1.38	44,40	1.75	37,90	550	3
EH22624	38,10	1.50	47,50	1.87	35,90	521	3
EH22626	41,10	1.62	50,50	1.99	34,50	501	3
EH22628	44,40	1.75	53,80	2.12	32,60	473	3
EH22630	47,80	1.88	57,20	2.25	31,00	450	3
EH22632	50,80	2.00	60,20	2.37	30,50	442	3
EH22634	54,10	2.13	63,50	2.50	29,30	425	3
EH22636	57,20	2.25	66,50	2.62	28,50	413	3
EH22638	60,50	2.38	69,90	2.75	27,60	400	3
EH22640	63,50	2.50	72,90	2.87	26,10	379	3
EH22642	66,50	2.62	75,90	2.99	24,20	351	3
EH22644	69,80	2.75	79,20	3.12	23,30	338	3
EH22646	73,20	2.88	82,60	3.25	22,10	321	3
EH22648	76,20	3.00	85,60	3.37	21,90	317	3
EH22650	79,50	3.13	88,90	3.50	21,20	308	3
EH22652	82,60	3.25	91,90	3.62	20,50	298	3
EH22654	85,90	3.38	95,20	3.75	19,00	275	3
EH22656	86,90	3.50	98,30	3.87	18,20	264	3
EH22658	92,20	3.63	101,60	4.00	17,60	256	3
EH22660	95,20	3.75	104,60	4.12	17,20	249	3
EH22664	101,60	4.00	111,00	4.37	16,10	233	3
EH22666	104,90	4.13	114,60	4.51	N/A	N/A	3
EH22668	108,00	4.25	117,90	4.84	N/A	N/A	3
EH22672	114,30	4.50	123,70	4.87	N/A	N/A	3
EH22680	127,00	5.00	136,40	5.37	N/A	N/A	3
EH22688	139,70	5.50	149,10	5.87	N/A	N/A	3
EH22696	152,40	6.00	161,80	6.37	N/A	N/A	3

Construction

Tube: Silicone

Reinforcement: 4-ply woven polyester

Cover: Blue

Operating parameters

-54°C to +177°C
(-65°F to +350°F)

Application

- Coolant engine

For additional sizes and configurations refer to Eaton bulletin E-HOOV-MC004-E3.

Transportation

Truck and engine maintenance - Silicone hose

F

EH227

Turbo hose, 4-Ply

Meets SAE J20R1, Class A



# Part number	Hose I.D.		Hose O.D.		Minimum burst pressure		Length ft/box
	mm	in	mm	in	bar	psi	
EH22704	6,40	0.25	14,50	0.57	32,9	477	3
EH22706	9,70	0.38	17,80	0.70	32,9	477	3
EH22708	12,70	0.50	20,80	0.82	29,3	425	3
EH22710	16,00	0.63	24,10	0.95	25,9	376	3
EH22712	19,10	0.75	27,20	1.07	22,4	325	3
EH22714	22,40	0.88	30,50	1.20	22,4	325	3
EH22716	25,40	1.00	33,50	1.32	20,6	300	3
EH22717	26,90	1.06	35,10	1.38	20,6	300	3
EH22718	28,70	1.13	36,80	1.45	19,0	276	3
EH22720	31,80	1.25	39,90	1.57	19,0	276	3
EH22721	33,30	1.31	41,40	1.63	19,0	276	3
EH22722	35,10	1.38	43,20	1.70	19,0	276	3
EH22724	38,10	1.50	46,20	1.82	17,2	249	3
EH22726	41,10	1.62	49,30	1.94	17,2	249	3
EH22728	44,40	1.75	52,60	2.07	15,5	225	3
EH22730	47,80	1.88	55,90	2.20	13,8	200	3
EH22732	50,80	2.00	58,90	2.32	13,8	200	3
EH22734	54,10	2.13	62,20	2.45	12,1	175	3
EH22736	57,20	2.25	65,30	2.57	12,1	175	3
EH22738	60,50	2.38	68,60	2.70	12,1	175	3
EH22740	63,50	2.50	71,60	2.82	10,3	149	3
EH22742	66,50	2.62	74,70	2.94	8,6	125	3
EH22744	69,80	2.75	78,00	3.07	8,6	125	3
EH22746	73,20	2.88	81,30	3.20	6,0	87	3
EH22748	76,20	3.00	84,30	3.32	6,0	87	3
EH22750	79,50	3.13	87,60	3.45	5,2	75	3
EH22752	82,60	3.25	90,70	3.57	5,2	75	3
EH22754	85,90	3.38	94,00	3.70	5,2	75	3
EH22756	88,90	3.50	97,00	3.82	5,2	75	3
EH22758	92,20	3.63	100,30	3.95	3,8	49	3
EH22760	95,20	3.75	103,40	4.07	3,8	49	3
EH22764	101,60	4.00	109,70	4.32	3,8	49	3
EH22772	114,30	4.50	122,40	4.82	3,8	49	3
EH22780	127,00	5.00	135,10	5.32	3,8	49	3

Construction

Tube: Silicone

Reinforcement: 4-ply woven aramid

Cover: Red

Operating parameters

-54°C to +260°C
(-65°F to +500°F)

Application

- High temperature engine

For additional sizes and configurations refer to Eaton bulletin E-HOOV-MC004-E3.

GH100

Braided textile - diesel and biodiesel hose

High temperature, low pressure oil
Meets: ASTM D380, ASTM D6751, EN412, EN2240



#	Hose I.D.		Hose O.D.		Maximum operating pressure		Minimum burst pressure		Minimum bend radius		Vacuum service		Weight	
	DN	mm in	mm in	bar psi	bar psi	mm in	mm in	kPa in	kg/m lbs/ft					
GH100-4	6	6,4 0.25	13,3 0.53	28,0 400	112,0 1600	31,8 1.25	94,8 28	0,12 0.08						
GH100-6	10	9,5 0.38	15,9 0.62	28,0 400	112,0 1600	38,1 1.50	94,8 28	0,15 0.10						
GH100-8	12	12,7 0.50	19,1 0.75	28,0 400	112,0 1600	50,8 2.00	94,8 28	0,19 0.13						
GH100-10	16	15,9 0.63	23,1 0.91	24,0 350	96,0 1400	63,5 2.50	94,8 28	0,27 0.18						
GH100-12	19	19,2 0.75	27,9 1.10	24,0 350	96,0 1200	76,2 3.00	94,8 28	0,30 0.20						

Construction

Tube: Eaton developed HNBR

Reinforcement: Aramid braid

Cover: Fiber braid

Operating parameters

Up to B20:
-40°C to +150°C
(-40°F to +302°F)

Up to B100:
-40°C to +125°C
(-40°F to +257°F)

Oil -Transmission application
-40°C to +165°C
-40°F to 320°F

Application

- Engine fuel systems for diesel and biodiesel use
- Low pressure oil applications, including synthetics for transmission oil cooler applications
- Qualified with ultra-low-sulfur diesel (ULSD), every blend of biodiesel up to B100, and a variety of synthetic oils

For more information on agency listings, specific fluid applications and high temperature ratings see section A.

Fitting reference

Crimp

OTC	H-5-56
-----	--------

Contact Eaton for custom tube designs.

GH101

CPE rubber - diesel and biodiesel hose

High temperature, low pressure oil
Meets: ASTM D380, ASTM D6751, EN412, EN2240



#	Hose I.D.		Hose O.D.		Maximum operating pressure		Minimum burst pressure		Minimum bend radius		Vacuum service		Weight	
	DN	mm in	mm in	bar psi	bar psi	mm in	mm in	kPa in	kg/m lbs/ft					
GH101-4	7	6,4 0.25	14,6 0.57	28,0 400	112,0 1600	31,8 1.25	94,8 28	0,14 0.09						
GH101-6	10	9,5 0.38	17,4 0.59	28,0 400	112,0 1600	38,1 2.00	94,8 28	0,18 0.12						
GH101-8	12	12,7 0.50	21,2 0.83	28,0 400	112,0 1600	50,8 2.50	94,8 28	0,25 0.17						
GH101-10	16	15,9 0.62	24,5 0.96	24,0 350	112,0 1400	69,8 3.00	94,8 28	0,28 0.19						

Construction

Tube: Eaton developed HNBR

Reinforcement: Aramid braid

Cover: CPE Cover

Operating parameters

Up to B20:
-40°C to +150°C
(-40°F to +302°F)

Up to B100:
-40°C to +125°C
(-40°F to +257°F)

Application

- Engine fuel systems for diesel and biodiesel use
- Low pressure oil applications, including synthetics for transmission oil cooler applications

For more information on agency listings, specific fluid applications and high temperature ratings see section A.

Fitting reference

Crimp

OTC	H-5-56
-----	--------

Contact Eaton for custom tube designs; Brass connections, composite connections and brass crimp fitting options.

Transportation

Truck and engine maintenance - Engine and air brake

F

FC355

Engine and air brake hose

Meets: SAE J1402, DOT/FMVSS 106 Type All



# Part number	Hose I.D.		Hose O.D.		Maximum operating pressure		Minimum burst pressure		Minimum bend radius		Vacuum service		Weight	
	mm	in	mm	in	bar	psi	bar	psi	mm	in	kPa	in	kg/m	lbs/ft
FC355-04	4,8	0.19	13,2	0.52	105,0	1500	420,0	6000	19,1	0.75	94,8	28	0,22	0.17
FC355-06	7,9	0.31	17,3	0.68	105,0	1500	420,0	6000	31,8	1.25	94,8	28	0,35	0.24
FC355-08	10,4	0.41	19,6	0.77	87,0	1250	350,0	5000	44,5	1.75	94,8	28	0,43	0.29
FC355-10	12,7	0.50	23,9	0.94	87,0	1250	350,0	5000	57,2	2.25	94,8	28	0,59	0.40
FC355-12	16,0	0.63	27,4	1.08	52,0	750	210,0	3000	69,9	2.75	67,7	20	0,68	0.46
FC355-16	22,4	0.88	31,5	1.24	28,0	400	112,0	1600	88,9	3.50	50,8	15	0,74	0.50
FC355-20	28,7	1.13	38,6	1.52	21,0	300	87,0	1250	114,3	4.50	50,8	15	0,87	0.59
FC355-24	35,1	1.38	44,5	1.75	17,0	250	70,0	1000	139,7	5.50	37,2	11	1,02	0.69
FC355-32	46,0	1.81	56,4	2.22	14,0	200	56,0	800	215,9	8.50	37,2	11	1,37	0.93

Construction

Tube: AQP elastomer

Reinforcement: Polyester inner braid and a single wire braid

Cover: Blue AQP elastomer

Operating parameters

-40°C to +150°C
(-40°F to +302°F)

Air not to exceed
250 psi or +121°C (+250°F)

Biodiesel use up to B20
and max temperature of
+100°C (+212°F)

Application

- Air brake, gasoline, fuel, lubricating oils and coolants

For more information on agency listings, specific fluid applications and high temperature ratings see section A.

Fitting reference	Page
Crimp	
100R5 FJ	H-80-86
Reusable	
SAE 100R5 style	I-4-16

FC350

Engine and air brake hose

Meets: SAE J1402, DOT/FMVSS 106 Type All



# Part number	Hose I.D.		Hose O.D.		Maximum operating pressure		Minimum burst pressure		Minimum bend radius		Vacuum service		Weight	
	mm	in	mm	in	bar	psi	bar	psi	mm	in	kPa	in	kg/m	lbs/ft
FC350-04	4,8	0.19	13,2	0.52	140,0	2000	560,0	8000	19,1	0.75	94,8	28	0,22	0.13
FC350-05	6,4	0.25	14,7	0.58	105,0	1500	420,0	6000	25,4	1.00	94,8	28	0,34	0.16
FC350-06	7,9	0.31	17,3	0.68	105,0	1500	420,0	6000	31,8	1.25	94,8	28	0,35	0.20
FC350-08	10,4	0.41	19,6	0.77	87,0	1250	350,0	5000	44,5	1.75	94,8	28	0,43	0.23
FC350-10	12,7	0.50	23,9	0.94	87,0	1250	350,0	5000	57,2	2.25	94,8	28	0,59	0.33
FC350-12	16,0	0.63	27,4	1.08	52,0	750	210,0	3000	69,9	2.75	67,7	20	0,68	0.39
FC350-16	22,4	0.88	31,2	1.23	28,0	400	112,0	1600	88,9	3.50	50,8	15	0,74	0.50
FC350-20	28,4	1.12	38,1	1.50	21,0	300	84,0	1200	114,3	4.50	50,8	15	0,87	0.56
FC350-24	35,1	1.38	44,5	1.75	17,0	250	70,0	1000	139,7	5.50	37,2	11	1,02	0.63

Construction

Tube: AQP elastomer

Reinforcement: Polyester inner braid and a single wire braid

Cover: Black textile braided

Operating parameters

-49°C to +150°C
(-55°F to +302°F)

Air not to exceed
+121°C (+250°F)

Biodiesel use up to B20
and max temperature of
100°C (212°F)

Application

- Air brake, gasoline, fuel, lubricating oils and coolants

For more information on agency listings, specific fluid applications and high temperature ratings see section A.

Fitting reference	Page
Crimp	
100R5 FJ	H-80-86
Reusable	
SAE 100R5 style	I-4-16

Transportation

Truck and engine maintenance - Engine and air brake

F

FC300

Textile and wire braid

Meets or exceeds: SAE 100R5, SAE J1019, SAE J1402, DOT/FMVSS 106 Type All



# Part number	Hose I.D.		Hose O.D.		Maximum operating pressure		Minimum burst pressure		Minimum bend radius		Vacuum service		Weight	
	mm	in	mm	in	bar	psi	bar	psi	mm	in	kPa	in	kg/m	lbs/ft
FC300-04	4,8	0.19	13,2	0.52	210,0	3000	840,0	12000	76,2	3.00	94,8	28	0,19	0.13
FC300-05	6,4	0.25	14,7	0.58	210,0	3000	840,0	12000	85,9	3.38	94,8	28	0,24	0.16
FC300-06	7,9	0.31	17,3	0.67	157,0	2250	630,0	9000	101,6	4.00	94,8	28	0,27	0.23
FC300-08	10,4	0.41	19,6	0.76	140,0	2000	560,0	8000	117,3	4.62	94,8	28	0,32	0.26
FC300-10	12,7	0.50	23,4	0.93	122,0	1750	490,0	7000	139,7	5.50	94,8	28	0,49	0.37
FC300-12	16,0	0.63	27,4	1.08	105,0	1500	420,0	6000	165,1	6.50	94,8	28	0,58	0.46
FC300-16	22,4	0.88	31,2	1.27	56,0	800	224,0	3200	187,5	7.38	67,7	20 [†]	0,55	0.44
FC300-20 ^{†‡}	28,4	1.12	38,1	1.50	43,0	625	175,0	2500	228,6	9.00	67,7	20 [†]	0,68	0.52
FC300-24 ^{†‡}	35,1	1.38	44,5	1.75	35,0	500	140,0	2000	266,7	10.50	50,8	15 [†]	0,92	0.67
FC300-32 ^{†‡}	46,0	1.81	56,4	2.22	21,0	300	84,0	1200	336,6	13.25	37,3	11 [†]	1,28	0.94
FC300-40 ^{†‡}	60,1	2.38	73,2	2.88	21,0	300	84,0	1200	609,6	24.00	27,1	8 [†]	2,11	1.50

[†] Maximum negative pressure shown for -16 and larger are suitable for those which has suffered no external damage or kinking. If greater negative pressures are required for -16 and larger hoses, the use of an internal support coil is recommended

[‡] Does not meet SAE 100R5 pressure with reusable fittings. -32 size rated to 350 psi with crimp fittings

Construction

Tube: AQP elastomer

Reinforcement: Polyester inner braid, single wire braid

Cover: Blue textile braid

Operating parameters

-49°C to +150°C
(-55°F to +302°F)

Air not to exceed
+121°C (+250°F)

Use with biodiesel
not to exceed +100°C
(+212°F) with B2 to B20

Application

- Hydraulics handling petroleum base fluids
- Air, gasoline, fuel and lubricating oils, fire resistant hydraulic fluids and other industrial fluids
- Not approved for use with E85

For more information on agency listings, specific fluid applications and high temperature ratings see section A.

Fitting reference	Page
Crimp	
100R5 FJ	H-80-86
Reusable	
SAE 100R5 style	I-4-16

FC650

High temperature engine, fuel and oil hose



# Part number	Hose I.D.		Hose O.D.		Maximum operating pressure		Minimum burst pressure		Minimum bend radius		Vacuum service		Weight	
	mm	in	mm	in	bar	psi	bar	psi	mm	in	kPa	in	kg/m	lbs/ft
FC650-04	4,8	0.19	12,2	0.48	70,0	1000	280,0	4000	19,1	0.75	94,8	28	0,15	0.10
FC650-06	7,9	0.31	16,0	0.63	70,0	1000	280,0	4000	31,8	1.25	94,8	28	0,22	0.15
FC650-08	10,4	0.41	18,8	0.74	70,0	1000	280,0	4000	44,5	1.75	94,8	28	0,28	0.19
FC650-10	12,7	0.50	21,1	0.83	70,0	1000	280,0	4000	57,2	2.25	94,8	28	0,34	0.23
FC650-12	16,0	0.63	25,1	0.99	70,0	1000	280,0	4000	69,9	2.75	67,7	20	0,41	0.28

Construction

Tube: AQP elastomer
Reinforcement: Single wire braid
Cover: Black polyester braided

Operating parameters

-49°C to +150°C
 (-55°F to +302°F)
 Air not to exceed +121°C (+250°F)

Application

- Diesel fuel, gasoline, lubricating oils, water, coolant and air
- Not approved for air brake applications

For more information on agency listings, specific fluid applications and high temperature ratings see section A.

Fitting reference

Factory crimp fittings available. Contact Eaton for details. For -4 only, the 100R5 crimp fitting is qualified.

FC699

High temperature fuel and oil hose



# Part number	Hose I.D.			Hose O.D.		Maximum operating pressure		Minimum burst pressure		Minimum bend radius		Vacuum service		Weight	
	DN	mm	in	mm	in	bar	psi	bar	psi	mm	in	kPa	in	kg/m	lbs/ft
FC699-04	6	6,4	0.25	12,4	0.49	28,0	400	112,0	1600	31,8	1.25	94,8	28	0,09	0.06
FC699-06	10	9,7	0.38	16,0	0.63	28,0	400	112,0	1600	38,1	1.50	94,8	28	0,15	0.10
FC699-08	12	12,7	0.50	19,6	0.77	28,0	400	112,0	1600	50,8	2.00	94,8	28	0,19	0.13
FC699-10	16	16,0	0.63	23,9	0.94	24,0	350	98,0	1400	63,5	2.50	61,0	18	0,27	0.18
FC699-12	19	19,1	0.75	27,4	1.08	21,0	300	83,0	1200	101,6	4.00	61,0	18	0,30	0.20
FC699-16	25	25,4	1.00	33,8	1.33	17,0	250	70,0	1000	114,3	4.50	61,0	18	0,41	0.28

Construction

Tube: AQP elastomer
Reinforcement: Single aramid braid
Cover: Black textile braided

Operating parameters

-40°C to +150°C
 (-40°F to +302°F)
 Air not to exceed 250 psi or +121°C (+250°F)
 Biodiesel use up to B20 and max temperature of +100°C (+212°F)

Application

- Diesel fuel, gasoline, crude and lubricating oils
- Transmission oil cooler

For more information on agency listings, specific fluid applications and high temperature ratings see section A.

Fitting reference

Crimp	Page
OTC	H-5-56

Transportation

Truck and engine maintenance - fuel and oil hose

F

FC234

High temperature fuel and oil hose

Fire resistant USCG/MMT, NMMA/BIA
Meets: SAE J1527 Type A1



# Part number	Hose I.D.		Hose O.D.		Maximum operating pressure		Minimum burst pressure		Minimum bend radius		Vacuum service		Weight	
	mm	in	mm	in	bar	psi	bar	psi	mm	in	kPa	in	kg/m	lbs/ft
FC234-05	6,4	0.25	14,7	0.58	105,0	1500	420,0	6000	25,4	1.00	94,8	28	0,32	0.22
FC234-06	7,9	0.31	17,3	0.68	105,0	1500	420,0	6000	31,8	1.25	94,8	28	0,37	0.25
FC234-08	10,4	0.41	19,3	0.76	87,0	1250	350,0	5000	44,5	1.75	94,8	28	0,44	0.30
FC234-10	12,7	0.50	23,9	0.94	87,0	1250	350,0	5000	57,2	2.25	94,8	28	0,66	0.45
FC234-12	16,0	0.63	27,4	1.08	52,0	750	210,0	3000	69,9	2.75	67,7	20	0,71	0.48
FC234-16	22,4	0.88	31,5	1.24	28,0	400	112,0	1600	88,9	3.50	54,2	16	0,75	0.51

Construction

Tube: AQP elastomer

Reinforcement: Brass plated steel wire braided refractory insulation

Cover: Blue AQP elastomer

Operating parameters

-40°C to +150°C
(-40°F to +302°F)

Use with biodiesel not to exceed +100°C (+212°F) with B2 to B20

Application

- Diesel fuel, gasoline,
- Hot lube oil
- Water

For more information on agency listings, specific fluid applications and high temperature ratings see section A.

Fitting reference	Page
Crimp	
100R5 FJ	H-80-86
Reusable	
SAE 100R5 style	I-4-16

FC321 LPG

Meets: UL Listing MH6044



F

# Part number	Hose I.D.		Hose O.D.		Maximum operating pressure		Minimum burst pressure		Minimum bend radius		Weight	
	mm	in	mm	in	bar	psi	bar	psi	mm	in	kg/m	lbs/ft
FC321-04	4,8	0.19	13,2	0.52	24,0	350	122,0	1750	38,1	1.50	0,16	0.11
FC321-06	7,9	0.31	17,0	0.67	24,0	350	122,0	1750	50,8	2.00	0,27	0.18
FC321-08	10,4	0.41	19,6	0.77	24,0	350	122,0	1750	58,7	2.31	0,31	0.21
FC321-10	12,7	0.50	23,4	0.92	24,0	350	122,0	1750	69,9	2.75	0,43	0.29
FC321-12	16,0	0.63	27,4	1.08	24,0	350	122,0	1750	82,6	3.25	0,55	0.37
FC321-16	22,4	0.88	31,5	1.24	24,0	350	122,0	1750	93,7	3.69	0,56	0.38

Construction

Tube: Synthetic rubber

Reinforcement: Textile inner braid, a stainless steel wire braid

Cover: Synthetic rubber impregnated textile braid

Operating parameters

-40°C to +121°C
(-40°F to +250°F)

Application

- Designed for butane-propane applications on either mobile or stationary equipment

For more information on agency listings, specific fluid applications and high temperature ratings see section A.

WARNING: LPG is a very hazardous liquid or gas and should be handled with maximum care to prevent leakage. Since the gas is heavier than air, it may flow along the ground if it escapes and cause an explosion or a fire. No leakage should ever be tolerated.

Fitting reference	Page
-------------------	------

Reusable	
-----------------	--

SAE 100R5 style	I-4-16
-----------------	--------

Transportation

Alternative fuel - LPG hose

F

CR170 LPG

Meets: CGA Type III (Canadian Gas Association)



# Part number	Hose I.D.		Hose O.D.		Maximum operating pressure		Minimum burst pressure		Minimum bend radius		Weight	
	mm	in	mm	in	bar	psi	bar	psi	mm	in	kg/m	lbs/ft
CR170-04	4,8	0.19	13,2	0.52	24,0	350	840,0	12000	76,2	3.00	0,24	0.16
CR170-06	7,9	0.31	17,0	0.67	24,0	350	630,0	9000	101,6	4.00	0,32	0.22
CR170-08*	10,4	0.41	19,6	0.77	24,0	350	560,0	8000	117,3	4.62	0,38	0.26
CR170-12*	15,9	0.63	28,0	1.10	24,0	350	414,0	6000	165,1	6.50	0,71	0.48

* Sizes 8 & 12 only are UL MH60773

Construction

Tube: Nylon

Reinforcement: Single stainless steel braid

Cover: Perforated synthetic rubber

Operating parameters

-40°C to +121°C
(-40°F to +250°F)

Application

- LPG (propane) vehicle, alternative fuel conversion systems

For more information on agency listings, specific fluid applications and high temperature ratings see section A.

WARNING: LPG is a very hazardous liquid or gas and should be handled with maximum care to prevent leakage. Since the gas is heavier than air, it may flow along the ground if it escapes and cause an explosion or a fire. No leakage should ever be tolerated.

Fitting reference

Must be CGA certified to crimp assemblies.

Factory crimp hose assemblies available. Contact Eaton for details.

Synflex 35NG
High pressure CNG hose

Meets: ANSI/CSA NGV4.2-2014 CSA 12.52-2014,
 ANSI/CSA NGV 3.1-2014/CSA 12.3-2014



# Part number	Hose size	Hose I.D.			Hose O.D.		Maximum working pressure		Minimum burst pressure		Minimum bend radius		Weight		Package Length	
		DN	mm	in	mm	in	bar	psi	bar	psi	mm	in	kg/m	lbs/ft	m	ft
35NG-04-250BX	-04	6	6,4	0.25	16,0	0.63	345	5,000	1,379	20,000	51,0	2.00	0,16	0.11	76,2	250
35NG-06-250BX	-06	10	9,7	0.38	19,5	0.77	345	5,000	1,379	20,000	102,0	4.00	0,22	0.15	76,2	250
35NG-08-250BX	-08	12	12,8	0.50	22,5	0.89	345	5,000	1,379	20,000	140,0	5.50	0,31	0.21	76,2	250
Twin-Line																
35NG-0404-250BX	04, -04	-	-	-	-	-	345	5,000	1,379	20,000	51,0	2.00	0,32	0.23	76,2	250
35NG-0406-250BX	04, -06	-	-	-	-	-	345	5,000	1,379	20,000	51,0	2.00	0,38	0.27	76,2	250
35NG-0408-250BX	04, -08	-	-	-	-	-	345	5,000	1,379	20,000	51,0	2.00	0,47	0.33	76,2	250

Construction

Tube: Conductive nylon core

Reinforcement:
 Synthetic fiber

Cover: Black perforated polyurethane

Operating parameters

-40°C to +85°C
 (-40°F to +185°F)

Application

- CNG refueling dispensers
- CNG transfer lines
- High-pressure CNG lines

Features

- Dissipates static electricity
- Low volumetric expansion
- UV resistant cover
- Twin-line designs available with vent hose
- Designed for electrically conductive fittings

For more information refer to the Synflex Thermoplastic Hose and Fittings E-HOOV-MC001-E.

Fitting reference

Factory made hose assemblies are available for Eaton distribution. Contact Eaton for details.

Eaton factory certified assemblies are available for purchase.

See product brochure E-HOTH-TT001-E for fitting and certification information.

Certified by:



Transportation

Alternative fuel - CNG hose

F

NG-TW

Low pressure CNG hose

Meets: ANSI/CSA NGV4.2-2014 CSA 12.52-2014,
ANSI/CSA NGV 3.1-2014/CSA 12.3-2014, ECE R110

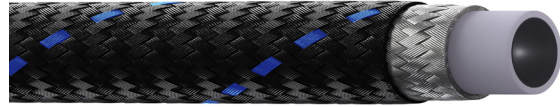

# Part number	Hose I.D.		Hose O.D.		Maximum operating pressure		Minimum burst pressure		Minimum bend radius		Weight	
	mm	in	mm	in	bar	psi	bar	psi	mm	in	kg/m	lbs/ft
NG-6TW	7,9	0.31	13,6	0.54	30	435	104	1508	101.6	4.00	0,18	0.12
NG-8TW	10,6	0.42	16,4	0.65	30	435	120	1740	133.4	5.25	0,24	0.16
NG-10TW	12,7	0.50	19,1	0.75	30	435	104	1508	165.1	6.50	0,27	0.18

Construction

Tube: Conductive Teflon inner tube

Reinforcement: 304 stainless steel wire braid

Cover: Fire resistant black/polyester blend cover with a blue tracer

Teflon™ is a trademark of The Chemours Company FC, LLC used under license by Eaton.

Operating parameters

-40°C to +120°C
(-40°F to +248°F)

Application

- Designed for low pressure, high temperature CNG applications on equipment or vehicles

Features

- Dissipates static electricity
- Low volumetric expansion
- UV resistant cover
- Designed for electrically conductive fittings
- Eaton factory certified assemblies are available for purchase

For more information on agency listings, specific fluid applications and high temperature ratings see section A.

Fitting reference

Must be TUV certified to crimp assemblies.

Factory made hose assemblies are available for Eaton distribution. Contact Eaton for details.

See product brochure E-HOTH-TT001-E for fitting and certification information.

Certified by:



Teflon hose

Everflex smooth bore

S-Series	G-3
SC-Series	G-4
S-TW Series	G-5
SC-TW Series	G-6
HI-PSI Series	G-7

Specialty and truck

2807	G-8
8000	G-9
8500	G-9
FC740	G-10

G

Teflon™ is a trademark of The Chemours Company FC, LLC used under license by Eaton.



Teflon hose

G

Everflex smooth bore

S-Series Smooth bore non-dissipating G-3



SC-Series Smooth bore static dissipating G-4



S-TW Series Smooth bore non-dissipating G-5



SC-TW Series Smooth bore static dissipating G-6



Hi-PSI Series Smooth bore static dissipating G-7



Specialty and truck

2807 PTFE G-8



8000 Non-conductive G-9



8500 Conductive G-9



FC740 Smooth bore static dissipating G-10

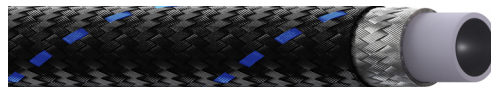

S-Series

Everflex smooth bore non-dissipating



# Part number	Hose I.D.		Hose O.D.		Working pressure		Minimum burst pressure		Minimum bend radius		Weight		Vacuum service
	mm	in	mm	in	bar	psi	bar	psi	mm	in	Kg/m	lbs/ft	In/Hg
304 Stainless steel braid													
S-3	3,2	0.13	6,8	0.27	241	3,500	965	14,000	25,4	1.00	0,07	0.05	28
S-4	4,8	0.19	8,6	0.34	206	3,000	827	12,000	38,1	1.50	0,12	0.08	28
S-5	6,4	0.25	10,2	0.40	206	3,000	827	12,000	50,8	2.00	0,13	0.09	28
S-6	7,9	0.31	11,7	0.46	172	2,500	689	10,000	88,9	3.50	0,18	0.12	28 ‡
S-8	10,4	0.41	14,7	0.58	137	2,000	551	8,000	114,3	4.50	0,22	0.15	28 ‡
S-10 *	12,7	0.50	17,3	0.68	120	1,750	482	7,000	127,0	5.00	0,30	0.20	28 ‡
S-12 *	15,7	0.62	20,3	0.80	103	1,500	413	6,000	152,4	6.00	0,34	0.23	28 ‡
S-16	22,4	0.88	27,2	1.07	68	1,000	275	4,000	228,6	9.00	0,46	0.31	12 ‡
S-16Z ◊	22,4	0.88	28,7	1.13	86	1,250	344	5,000	185,4	7.30	0,73	0.49	12 ‡
S-20Z ◊	28,4	1.12	35,3	1.39	68	1,000	275	4,000	279,4	11.00	0,97	0.65	12 ‡
316 Stainless steel braid													
S316-4	4,8	0.19	8,6	0.34	206	3,000	827	12,000	38,1	1.50	0,12	0.08	28
S316-6	7,9	0.31	11,7	0.46	172	2,500	689	10,000	88,9	3.50	0,18	0.12	28 ‡
S316-8	10,4	0.41	14,7	0.58	103	1,500	414	6,000	114,3	4.50	0,22	0.15	28 ‡
S316-12	15,7	0.62	20,1	0.78	86	1,250	345	5,000	152,4	6.00	0,34	0.23	28 ‡
S316-16	22,4	0.88	27,2	1.07	62	900	248	3,600	228,6	9.00	0,46	0.31	12 ‡

Construction

Tube: Non-conductive Teflon inner tube

Cover: 304 or 316 stainless steel braid

Operating parameters

-54°C to +230°C
(-65°F to +450°F)

Application

- Steam
- Compressor discharge
- Chemical transfer
- 316 Stainless braided hose can be used in marine applications and other environments where corrosion is an issue

For more information on agency listings, specific fluid applications and high temperature ratings see section A or contact Eaton technical support.

Fitting reference

Fittings

For fitting selection see Everflex Catalog E-HOEV-MC001-E5.

For additional product information refer to the catalog E-HOEV-MC001-E5.

Warning: These hoses can be used to convey hazardous chemicals, steam, hot liquids or other dangerous materials which can cause death, serious bodily injury including burns, pressure wounds or chemical exposure if released accidentally. They should, therefore, only be handled or worked on by personnel properly trained in the safe handling of the materials or chemicals conveyed in the hoses.

◊ "Z" Designates a double braid of 304 stainless steel wire.

* The operating pressure of 1/2" I.D. hoses are lowered to 1500 psi and 5/8" I.D. hoses are lowered to 1250 psi when Brass Everswage fittings are used.

‡ Maximum negative pressure for -16 and larger are suitable for hose which has suffered no external damage or kinking. If greater negative pressures are required for -16 and larger hoses, the use of an internal support coil is recommended. Use of an internal support coil in -06 and larger hose is recommended for tube support where extended or continuous service at high temperature together with low or negative pressure is expected.

Teflon hose

Everflex smooth bore

G

SC-Series

Everflex smooth bore static dissipating

Carbon black used meets 21CFR178.3297 for FDA compliance



# Part number	Hose I.D.		Hose O.D.		Working pressure		Minimum burst pressure		Minimum bend radius		Weight		Vacuum service
	mm	in	mm	in	bar	psi	bar	psi	mm	in	Kg/m	lbs/ft	In/Hg
304 Stainless steel braid													
SC-3	3,2	0.13	6,8	0.27	241	3,500	965	14,000	25,4	1.00	0,07	0.05	28
SC-4	4,8	0.19	8,6	0.34	206	3,000	827	12,000	38,1	1.50	0,12	0.08	28
SC-5	6,4	0.25	10,2	0.4	206	3,000	827	12,000	50,8	2.00	0,13	0.09	28
SC-6	7,9	0.31	11,7	0.46	172	2,500	689	10,000	88,9	3.50	0,18	0.12	28 ‡
SC-8	10,4	0.41	14,7	0.58	137	2,000	551	8,000	114,3	4.50	0,22	0.15	28 ‡
SC-10 *	12,7	0.50	17,3	0.68	120	1,750	482	7,000	127,0	5.00	0,30	0.20	28 ‡
SC-12 *	15,7	0.62	20,3	0.8	103	1,500	413	6,000	152,4	6.00	0,34	0.23	28 ‡
SC-16	22,4	0.88	27,2	1.07	68	1,000	275	4,000	228,6	9.00	0,46	0.31	12 ‡
316 Stainless steel braid													
SC316-4	4,8	0.19	8,6	0.34	206	3,000	827	12,000	38,1	1.50	0,12	0.08	28
SC316-6	7,9	0.31	11,7	0.46	172	2,500	689	10,000	88,9	3.50	0,18	0.12	28 ‡
SC316-8	10,4	0.41	14,7	0.58	103	1,500	414	6,000	114,3	4.50	0,22	0.15	28 ‡
SC316-12	15,7	0.62	20,1	0.78	86	1,250	345	5,000	152,4	6.00	0,34	0.23	28 ‡
SC316-16	22,4	0.88	27,2	1.07	62	900	248	3,600	228,6	9.00	0,46	0.31	12 ‡

Construction

Tube: Conductive Teflon inner tube

Cover: One or two layers of stainless steel braid

Operating parameters

-54°C to +230°C
(-65°F to +450°F)

Application

- Steam
- Compressor discharge
- Chemical transfer
- 316 Stainless braided hose can be used in marine applications and other environments where corrosion is an issue

For more information on agency listings, specific fluid applications and high temperature ratings see section A or contact Eaton technical support.

Fitting reference

Fittings

For fitting selection see Everflex Catalog E-HOEV-MC001-E5.

For additional product information refer to the Everflex catalog E-HOEV-MC001-E5.

Warning: These hoses can be used to convey hazardous chemicals, steam, hot liquids or other dangerous materials which can cause death, serious bodily injury including burns, pressure wounds or chemical exposure if released accidentally. They should, therefore, only be handled or worked on by personnel properly trained in the safe handling of the materials or chemicals conveyed in the hoses.

‡ Maximum negative pressure for -16 and larger are suitable for hose which has suffered no external damage or kinking. If greater negative pressures are required for -16 and larger hoses, the use of an internal support coil is recommended. Use of an internal support coil in -06 and larger hose is recommended for tube support where extended or continuous service at high temperature together with low or negative pressure is expected.

◇ "Z" Designates a double braid of 304 stainless steel wire.

*The operating pressure of 1/2" I.D. hoses are lowered to 1500 psi and 5/8" I.D. hoses are lowered to 1250 psi when Brass Everswage fittings are used.

Teflon™ is a trademark of The Chemours Company FC, LLC used under license by Eaton.

S-TW Series
Everflex smooth bore non-dissipating

Meets: SAE 100R14A



Part number	Hose I.D.		Hose O.D.		Working pressure		Minimum burst pressure		Minimum bend radius		Weight		Vacuum service	Hose ends
	mm	in	mm	in	bar	psi	bar	psi	mm	in	Kg/m	lbs/ft	In/Hg	
304 Stainless steel braid														
S-4TW	4,8	0.19	8,2	0.32	207 *	3,000 *	827	12,000	50,8	2.00	0,09	0.06	28	Everswage Field Attachable E-Series/ER-Series
S-5TW	6,4	0.25	10,1	0.40	207	3,000	827	12,000	76,2	3.00	0,12	0.08	28	Everswage Field Attachable E-Series
S-6TW	7,9	0.31	11,6	0.46	172 *	2,500 *	689	10,000	101,6	4.00	0,15	0.10	28 ‡	Everswage Field Attachable E-Series/ER-Series
S-7TW	9,6	0.38	13,4	0.53	138	2,000	552	8,000	127,0	5.00	0,16	0.11	28 ‡	Everswage
S-8TW	10,4	0.41	14,3	0.56	138 *	2,000 *	552	8,000	127,0	5.00	0,18	0.12	28 ‡	Everswage Field Attachable E-Series/ER-Series
S-10TW*	12,7	0.50	16,8	0.66	121 *	1,750 *	483	7,000	165,1	6.50	0,25	0.17	28 ‡	Everswage Field Attachable E-Series/ER-Series
S-12TW	15,7	0.62	20,1	0.79	103 *	1,500 *	414	6,000	190,5	7.50	0,28	0.19	28 ‡	Everswage Field Attachable E-Series/ER-Series
S-14TW	19,1	0.75	23,3	0.92	69	1,000	276	4,000	215,9	8.50	0,37	0.25	28 ‡	E-Series
S-16TW	22,4	0.88	26,9	1.06	69 *	1,000 *	276	4,000	228,6	9.00	0,40	0.27	12 ‡	Everswage Field Attachable
S-18ZTW ◊	25,4	1.00	31,6	1.24	69	1,000	276	4,000	304,8	12.00	0,79	0.53	12 ‡	E-Series
316 Stainless steel braid														
S-4TW316SS	4,8	0.19	8,2	0.32	206	3,000	827	12,000	50,8	2.00	0,09	0.06	28	Everswage Field Attachable E-Series
S-16TW316SS	22,4	0.88	26,9	1.06	172	900	248	3,600	228,6	9.00	0,40	0.27	12 ‡	Everswage Field Attachable E-Series

Construction

Tube: Non-conductive Teflon inner tube

Cover: 304 or 316 stainless steel braid

*** Working pressure ratings with flat Crimped E-Series fittings only**

S-4TW	3,500 psi
S-6TW	2,750 psi
S-8TW	2,250 psi
S-10TW	2,000 psi
S-12TW	1,500 psi
S-16TW	1,200 psi
S-18ZTW	1,200 psi

Operating parameters

-54°C to +230°C
(-65°F to +450°F)

Application

- Steam
- Compressor discharge
- Chemical transfer

For additional product information refer to the Everflex catalog E-HOEV-MC001-E5.

For more information on agency listings, specific fluid applications and high temperature ratings see section A or contact Eaton technical support.

Fitting reference

Crimp

E Series: See brochure E-HOEV-MS002-E5

FC Series	H-78-79
-----------	---------

Reusable

Super Gem	I-57-60
-----------	---------



Warning: These hoses can be used to convey hazardous chemicals, steam, hot liquids or other dangerous materials which can cause death, serious bodily injury including burns, pressure wounds or chemical exposure if released accidentally. They should, therefore, only be handled or worked on by personnel properly trained in the safe handling of the materials or chemicals conveyed in the hoses.

‡ Maximum negative pressure for -16 and larger are suitable for hose which has suffered no external damage or kinking. If greater negative pressures are required for -16 and larger hoses, the use of an internal support coil is recommended. Use of an internal support coil in -06 and larger hose is recommended for tube support where extended or continuous service at high temperature together with low or negative pressure is expected.

◊ "Z" Designates a double braid of 304 stainless steel wire.

* The operating pressure of 1/2" I.D. hoses are lowered to 1,500 psi and 5/8" I.D. hoses are lowered to 1,250 psi when Brass Everswage fittings are used.

Teflon™ is a trademark of The Chemours Company FC, LLC used under license by Eaton.

Teflon hose

Everflex smooth bore

G

SC-TW Series

Everflex smooth bore static dissipating

Meets: 100R14B, carbon black used meets 21CFR178.3297 for FDA compliance



# Part number	Hose I.D.		Hose O.D.		Working pressure		Minimum burst pressure		Minimum bend radius		Weight		Vacuum service	Hose ends
	mm	in	mm	in	bar	psi	bar	psi	mm	in	Kg/m	lbs/ft	In/Hg	
304 Stainless steel braid														
SC-4TW	4,8	0.19	8,2	0.32	207 *	3,000 *	827	12,000	50,8	2.00	0,09	0.06	28	Everswage Field Attachable E-Series/ER-Series
SC-5TW	6,4	0.25	10,1	0.40	207	3,000	827	12,000	76,2	3.00	0,12	0.08	28	Everswage Field Attachable E-Series
SC-6TW	7,9	0.31	11,6	0.46	172 *	2,500 *	689	10,000	101,6	4.00	0,15	0.10	28 †	Everswage Field Attachable E-Series/ER-Series
SC-7TW	9,6	0.38	13,4	0.53	138	2,000	552	8,000	127,0	5.00	0,6	0.11	28 †	Everswage
SC-8TW	10,4	0.41	14,3	0.56	138 *	2,000 *	552	8,000	127,0	5.00	0,18	0.12	28 †	Everswage Field Attachable E-Series/ER-Series
SC-10TW*	12,7	0.50	16,8	0.66	121 *	1,750 *	483	7,000	165,1	6.50	0,25	0.17	28 †	Everswage Field Attachable E-Series/ER-Series
SC-12TW*	15,7	0.62	20,1	0.79	103 *	1,500 *	414	6,000	190,5	7.50	0,28	0.19	28 †	Everswage Field Attachable E-Series/ER-Series
SC-14TW	19,1	0.75	23,3	0.92	69	1,000	276	4,000	215,9	8.50	0,37	0.25	28 †	E-Series
SC-16TW	22,4	0.88	26,9	1.06	69 *	1,000 *	276	4,000	228,6	9.00	0,40	0.27	12 †	Everswage Field Attachable
SC-18ZTW ◊	25,4	1.00	31,6	1.24	69	1,000	276	4,000	304,8	12.00	0,79	0.53	12 †	E-Series
316 Stainless steel braid														
SC-4TW316SS	4,8	0.19	8,2	0.32	207	3,000	827	12,000	50,8	2.00	0,09	0.06	28	Everswage Field Attachable E-Series
SC-16TW316SS	22,4	0.88	26,9	1.06	62	900	248	3600	228,6	9.00	0,40	0.27	12	Everswage Field Attachable E-Series

Construction

Tube: Non-conductive Teflon

Cover: One or two layers of stainless steel braid

* Working pressure ratings with flat Crimped E-Series fittings only

S-4TW	3,500 psi
S-6TW	2,750 psi
S-8TW	2,250 psi
S-10TW	2,000 psi
S-12TW	1,500 psi
S-16TW	1,200 psi
S-18ZTW	1,200 psi

Operating parameters

-54°C to +230°C
(-65°F to +450°F)

For additional product information refer to the Everflex catalog E-HOEV-MC001-E5.



Warning: These hoses can be used to convey hazardous chemicals, steam, hot liquids or other dangerous materials which can cause death, serious bodily injury including burns, pressure wounds or chemical exposure if released accidentally. They should, therefore, only be handled or worked on by personnel properly trained in the safe handling of the materials or chemicals conveyed in the hoses.

‡ Maximum negative pressure for -16 and larger are suitable for hose which has suffered no external damage or kinking. If greater negative pressures are required for -16 and larger hoses, the use of an internal support coil is recommended. Use of an internal support coil in -06 and larger hose is recommended for tube support where extended or continuous service at high temperature together with low or negative pressure is expected.

◊ "Z" Designates a double braid of 304 stainless steel wire.

Application

- Steam
- Compressor discharge
- Chemical transfer
- 316 Stainless braided hose can be used in marine applications and other environments where corrosion is an issue

For more information on agency listings, specific fluid applications and high temperature ratings see section A or contact Eaton technical support.

Fitting reference

Crimp

E Series: See brochure E-HOEV-MS002-E5

FC Series	H-78-79
-----------	---------

Reusable

Super Gem	I-57-60
-----------	---------

Teflon™ is a trademark of The Chemours Company FC, LLC used under license by Eaton.

* The operating pressure of 1/2" I.D. hoses are lowered to 1500 psi and 5/8" I.D. hoses are lowered to 1250 psi when Brass Everswage fittings are used.

Hi-PSI Series
Everflex smooth bore static dissipating



# Part number	Hose I.D.		Hose O.D.		Working pressure at 72°		Working pressure at 400°		Minimum burst pressure		Minimum bend radius		Weight		Vacuum service	
	mm	in	mm	in	bar	psi	bar	psi	bar	psi	mm	in	Kg/m	lbs/ft	kPa	in/Hg
304 Stainless steel braid																
H504	5,6	0.22	9,8	0.39	345	5,000	207	3,000	1,103	16,000	38,1	1.50	0,15	0.10	94,8	28
H506	8,0	0.31	13,1	0.52	345	5,000	207	3,000	1,103	16,000	63,5	2.50	0,25	0.17	94,8 ‡	28 ‡
H508	10,3	0.41	16,0	0.63	345	5,000	207	3,000	1,103	16,000	73,7	2.90	0,36	0.24	94,8 ‡	28 ‡
H510	12,7	0.50	19,3	0.76	345	5,000	207	3,000	1,103	16,000	83,8	3.30	0,51	0.34	94,8 ‡	28 ‡
H512	16,5	0.65	25,1	0.99	345	5,000	207	3,000	1,103	16,000	101,6	4.00	1,02	0.68	94,8 ‡	28 ‡
H516	22,2	0.88	33,4	1.32	345	5,000	207	3,000	1,103	16,000	127,0	5.00	1,72	1.16	40,6 ‡	12 ‡
H520	28,6	1.13	41,1	1.62	345	5,000	207	3,000	1,103	16,000	304,8	12.00	2,47	1.66	40,6 ‡	12 ‡
H524	34,9	1.38	47,5	1.87	276	4,000	207	3,000	827	12,000	355,6	14.00	2,97	1.99	40,6 ‡	12 ‡

Construction

Tube: Heavy wall conductive Teflon inner tube
Cover: One or two layers of 304 stainless steel wire braid

Operating parameters

-54°C to +240°C
(-65°F to +400°F)

Application

- Steam
- Compressor discharge
- Chemical transfer
- High pressure applications

For additional product information refer to the Everflex catalog E-HOEV-MC001-E5.

For more information on agency listings, specific fluid applications and high temperature ratings see section A or contact Eaton technical support.

Fitting reference

Factory crimp only. For more information contact Eaton technical support.

Hose/Tube size	Insert part number	Collar part number	Female JIC thread size	Hose assembly part number
-4	H20004-4-316/4	H70000-4-304	7/16-20	FK4650EEE-Length
-6	H20006-6-316/4	H70000-6-304	9/16-18	FK4650GGG-Length
-8	H20008-8-316/4	H70000-8-304	3/4-16	FK4650HHH-Length
-10	H20010-10-316/4	H70000-10-304	7/8-14	FK4650JJJ-Length
-12*	H20012-12-316/4	H70000-12-304	1-1/16-12	FK4650KKK-Length
-16*	H20016-16-316/4	H70000-16-304	1-5/16-12	FK4650MMM-Length
-20**	H20020-20-316/4	H70000-20-304	1-5/8-12	FK4650NNN-Length
-24**	H20024-24-316/4	H70000-24-304	1-7/8-12	FK4650PPP-Length

Hose assemblies must be assembled by Eaton. Standard Stainless Steel JIC fittings are available.

* 55' Max length

** 25' Max length



Warning: These hoses can be used to convey hazardous chemicals, steam, hot liquids or other dangerous materials which can cause death, serious bodily injury including burns, pressure wounds or chemical exposure if released accidentally. They should, therefore, only be handled or worked on by personnel properly trained in the safe handling of the materials or chemicals conveyed in the hoses.

‡ Maximum negative pressure for -16 and larger are suitable for hose which has suffered no external damage or kinking. If greater negative pressures are required for -16 and larger hoses, the use of an internal support coil is recommended. Use of an internal support coil in -06 and larger hose is recommended for tube support where extended or continuous service at high temperature together with low or negative pressure is expected.

Teflon™ is a trademark of The Chemours Company FC, LLC used under license by Eaton.

Teflon hose

Specialty and truck

G

2807

PTFE

Meets: SAE 100R14A, DNV, USCG, ABS



# Part number	Hose I.D.		Hose O.D.		Maximum operating pressure		Minimum burst pressure		Minimum bend radius		Weight		Vacuum service	
	mm	in	mm	in	bar	psi	bar	psi	mm	in	kg/m	lbs/ft	kPa	in/Hg
2807-3	3,6	0.14	6,4	0.25	210,0	3000	840,0	12000	38,1	1.50	0,06	0.04	94,8	28
2807-4	4,8	0.19	7,6	0.30	210,0	3000	840,0	12000	50,8	2.00	0,09	0.06	94,8	28
2807-5	6,6	0.26	9,4	0.37	210,0	3000	840,0	12000	76,2	3.00	0,12	0.08	94,8	28
2807-6	8,1	0.32	10,9	0.43	175,0	2500	700,0	10000	101,6	4.00	0,15	0.10	94,8‡	28‡
2807-8	10,7	0.42	13,7	0.54	140,0	2000	560,0	8000	133,4	5.25	0,18	0.12	94,8‡	28‡
2807-10	13,0	0.51	16,0	0.63	105,0	1500	420,0	6000	165,1	6.50	0,24	0.16	94,8‡	28‡
2807-12	16,3	0.64	19,3	0.76	84,0	1200	335,0	4800	196,9	7.75	0,27	0.18	94,8‡	28‡
2807-16	22,4	0.88	26,2	1.03	70,0	1000	280,0	4000	228,6	9.00	0,39	0.26	40,6‡	12‡
2807-20	28,4	1.12	32,8	1.29	43,0	625	175,0	2500	406,4	16.00	0,51	0.34	40,6‡	12‡

Construction

Tube: Extruded PTFE tube

Cover: Single layer stainless steel wire braid

Operating parameters

-73°C to +260°C
(-100°F to +500°F)
Steam 200 psi at
+388°F max

Application

- Hot air, steam, compressor discharge
- Most chemical applications
- Not recommended for steam-cold water cycling

For more information on agency listings, specific fluid applications and high temperature ratings see section A or contact Eaton technical support.

For additional product information refer to the Everflex catalog E-HOEV-MC001-E5.

Fitting reference

Crimp

E Series: See brochure E-HOEV-MC001-E5

FC Series	H-78-79
-----------	---------

Reusable

Super Gem	I-57-60
-----------	---------



Warning: These hoses can be used to convey hazardous chemicals, steam, hot liquids or other dangerous materials which can cause death, serious bodily injury including burns, pressure wounds or chemical exposure if released accidentally. They should, therefore, only be handled or worked on by personnel properly trained in the safe handling of the materials or chemicals conveyed in the hoses.

‡ Maximum negative pressure for -06 and larger are suitable for hose which has suffered no external damage or kinking. If greater negative pressures are required for -06 and larger hoses, the use of an internal support coil is recommended. Use of an internal support coil in -06 and larger PTFE hose is recommended for tube support where extended or continuous service at high temperature together with low or negative pressure is expected.

8000 Series

Convuluted hose: Non-conductive



# Part number	Hose size	Nominal I.D.		Maximum nominal O.D.		Hose I.D.	Maximum operating pressure		Minimum burst pressure		Minimum bend radius		Weight		Vacuum service
		mm	in	mm	in		bar	psi	bar	psi	mm	in	kg/m	lbs/ft	
8008	-8	14,5	0.57	20,6	0.81	1/2	103	1500	413	6000	38,1	1.5	0,10	0.23	28
8012	-12	21,1	0.83	27,9	1.10	3/4	86	1250	345	5000	63,5	2.5	0,14	0.31	28
8016	-16	26,9	1.06	34,0	1.34	1	62	900	248	3600	76,2	3.0	0,19	0.42	20
8020	-20	33,3	1.31	40,6	1.60	1 1/4	62	900	248	3600	88,9	3.5	0,24	0.52	12
8024	-24	40,1	1.58	46,5	1.83	1 1/2	52	750	206	3000	114,3	4.5	0,27	0.59	10
8032	-32	52,3	2.06	60,5	2.38	2	35	500	138	2000	152,4	6.0	0,39	0.86	5

8500 Series

Convuluted hose: Conductive

Static dissipating



# Part number	Hose size	Nominal I.D.		Maximum nominal O.D.		Hose I.D.	Maximum operating pressure		Minimum burst pressure		Minimum bend radius		Weight		Vacuum service
		mm	in	mm	in		bar	psi	bar	psi	mm	in	kg/m	lbs/ft	
8508	-8	14,5	0.57	20,6	0.81	1/2	103	1500	413	6000	38,1	1.5	0,10	0.23	28
8512	-12	21,1	0.83	27,9	1.10	3/4	86	1250	345	5000	63,5	2.5	0,14	0.31	28
8516	-16	26,9	1.06	34,0	1.34	1	62	900	248	3600	76,2	3.0	0,19	0.42	20
8520	-20	33,3	1.31	40,6	1.60	1 1/4	62	900	248	3600	88,9	3.5	0,24	0.52	12
8524	-24	40,1	1.58	46,5	1.83	1 1/2	52	750	206	3000	114,3	4.5	0,27	0.59	10
8532	-32	52,3	2.06	60,5	2.38	2	35	500	138	2000	152,4	6.0	0,39	0.86	5

Construction

Tube: Convuluted Teflon tube
Conductive static dissipating black liner

Reinforcement: 304 stainless steel wire braid

Operating parameters

-54°C to +204°C
(-65°F to +400°F)

Application

- Automotive
- Platen presses
- Pharmaceutical
- Bus and truck
- Reverse osmosis
- Hydraulics
- Chemical processing
- Steam, air, water
- Tire manufacturing
- Electronics
- Steel mills
- Food processing
- Tank truck transfer
- 8500 Series is for applications where flow induced electrostatic charges can occur.

For more information on agency listings, specific fluid applications and high temperature ratings see section A or contact Eaton technical support.

For additional product information refer to the Everflex catalog E-HOEV-MC001-E5.

Fitting reference

See Eaton Everflex Hose Catalog E-HOEV-MC001-E5 for Conv-0-Crimp fitting options.

Factory crimp only. For more information contact Eaton technical support.

Warning: These hoses can be used to convey hazardous chemicals, steam, hot liquids or other dangerous materials which can cause death, serious bodily injury including burns, pressure wounds or chemical exposure if released accidentally. They should, therefore, only be handled or worked on by personnel properly trained in the safe handling of the materials or chemicals conveyed in the hoses.

Teflon hose

Specialty and truck

G

FC740

Smooth bore

Static dissipating

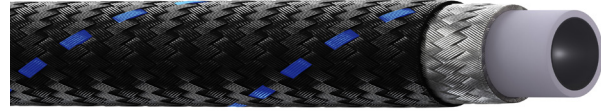

# Part number	Hose I.D.		Hose O.D.		Maximum operating pressure		Minimum burst pressure		Minimum bend radius		Weight		Vacuum service		Hose ends
	mm	in	mm	in	bar	psi	bar	psi	mm	in	kg/m	lbs/ft	kPa	in/Hg	
FC740-03	3,2	0.13	9,4	0.37	210	3000	840,0	12,000	38,1	1.50	0,10	0.07	94,8	28	Factory crimp only
FC740-04	4,8	0.19	10,7	0.42	210	3000	840,0	12,000	50,8	2.00	0,12	0.08	94,8	28	Factory crimp only
FC740-05	6,4	0.25	12,1	0.48	210	3000	840,0	12,000	76,2	3.00	0,15	0.10	94,8	28	Factory crimp only
FC740-06	7,9	0.31	13,6	0.54	175	2500	700,0	10,000	101,6	4.00	0,18	0.12	94,8†	28†	Factory crimp only
FC740-08	10,3	0.41	16,4	0.65	140	2000	560,0	8,000	133,4	5.25	0,24	0.16	94,8†	28†	Factory crimp only

Construction

Tube: Conductive extruded PTFE

Reinforcement: Stainless steel single wire braid

Cover: Fire resistant black polyester blend cover with a blue tracer

Operating parameters

-40°C to +260°C
(-40°F to +500°F)

Application

- Steam
- Compressor discharge
- Chemical transfer
- High temperature fuel line

For more information on agency listings, specific fluid applications and high temperature ratings see section A or contact Eaton technical support.

For additional product information refer to the Everflex catalog E-HOEV-MC001-E5.

Fitting reference

Contact Eaton technical support for additional fitting information.



Warning: These hoses can be used to convey hazardous chemicals, steam, hot liquids or other dangerous materials which can cause death, serious bodily injury including burns, pressure wounds or chemical exposure if released accidentally. They should, therefore, only be handled or worked on by personnel properly trained in the safe handling of the materials or chemicals conveyed in the hoses.

Crimp fittings

How to order	H-2	Spiral hose fittings (4S/6S Series)	H-57
Socket data	H-4	Teflon PTFE fittings (FC Series)	H-78
Braided one-piece fittings (TTC Series)	H-5-56	Truck and fuel (100R5 FJ Series)	H-80
Braided two-piece fittings (1SA Series)	H-5-56	Split flange kits	H-87
Low pressure OTC fittings (1GA Series)	H-5-56	O-Rings and kits	H-89
Four spiral non-skive fittings (TTC-12 Series)	H-5-56		

Teflon™ is a trademark of The Chemours Company FC, LLC used under license by Eaton.

H



Crimp fittings

How to order

H

How to order

Accurate processing and prompt delivery of your order depend on easy identification of your requirements. Please order Eaton parts using correct part numbers as described in this catalog. Inquiries and orders should be directed to your Aeroquip Distributor or:

Eaton Hydraulics
14615 Lone Oak Road
Eden Prairie, MN 55344
952-937-9800;
888-258-0222;
Fax: 952-974-7722
www.eaton.com/hydraulics

Part numbers and Dash sizes

Dash size designates the nominal size in 16ths of an inch. This number immediately follows the part number and is separated from it with a dash.

Fittings with "FC" or "FJ" part numbers will have the size expressed in four numerals. The first two numerals indicate the size of the connecting end and the second two numerals indicate the size of the hose end. All other fittings are followed by a dash number which is the nominal size of the fitting expressed in 16ths of an inch. Where two dash numbers are given, the first one generally indicates the pipe or port size and the second indicates the tube or hose size. The hose dash number should always be the same as the last dash number on the fitting.

Material Designation

Most fittings in this catalog have a material designation as part of the part number. An explanation is shown below.

Prefix Designations

- 38 Brass nipple, steel socket
- 44 Bronze nipple and nut: brass socket
- 63 Brass nipple, steel nut and socket
- 259 316 Stainless steel
- 449 Malleable iron

Suffix Designations

- B Brass
- C Stainless steel
- D Aluminum alloy
- S Steel

Dimensions

Dimensions given in this catalog for Eaton brand products are approximate and should be used for reference only. Exact dimensional information for a given product is subject to change and varying tolerances; contact Eaton directly for full current information.

Globally standardized pressure ratings

Eaton has standardized hose burst and operating pressure ratings in cataloging, worldwide. This move toward standardization will slightly alter some of the pressures ratings listed for hoses in this catalog as pressures are rounded off. This is a paper conversion only. This action has no effect on the actual testing and certification of Eaton hoses to stringent product standards.



Warning

Eaton manufactures the terminal ends of our hose fittings to the appropriate requirements established by the SAE. Therefore, the performance ratings of these hose fittings meet the SAE requirements. It is possible to order a hose assembly with a fitting terminal end that has a performance rating lower than the hose rating. When ordering hose assemblies, please keep the terminal end performance rating in mind since this may affect overall hose assembly performance.

Many hose assembly components (hose and fittings) are easily assembled in the field. However, factory assembled swaged, crimped and reusable hose assemblies are available. For complete information, contact Eaton.

Mixing/Matching

EATON FITTING TOLERANCES ARE ENGINEERED TO MATCH AEROQUIP HOSE TOLERANCES. THE USE OF EATON FITTINGS ON HOSE SUPPLIED BY OTHER MANUFACTURERS AND/OR THE USE OF AEROQUIP HOSE WITH FITTINGS SUPPLIED BY OTHER MANUFACTURERS' BRANDS MAY RESULT IN THE PRODUCTION OF UNRELIABLE AND UNSAFE HOSE ASSEMBLIES AND IS NEITHER RECOMMENDED NOR AUTHORIZED BY EATON.

EATON SHALL NOT BE SUBJECT TO AND DISCLAIMS ANY OBLIGATIONS OR LIABILITIES (INCLUDING BUT NOT LIMITED TO ALL CONSEQUENTIAL, INCIDENTAL AND CONTINGENT DAMAGES) ARISING OUT OF BREACH OF CONTACT OR OF WARRANTY OR ARISING FROM TORT CLAIMS (INCLUDING WITHOUT LIMITATION NEGLIGENCE AND STRICT LIABILITY) OR OTHER THEORIES OF LAW WITH RESPECT TO ANY HOSE ASSEMBLIES NOT PRODUCED FROM GENUINE EATON HOSE FITTINGS, HOSE AND EATON APPROVED EQUIPMENT, AND IN CONFORMANCE WITH EATON PROCESS AND PRODUCT INSTRUCTIONS FOR EACH SPECIFIC HOSE ASSEMBLY.

FAILURE TO FOLLOW EATON PROCESS AND PRODUCT INSTRUCTIONS AND LIMITATIONS COULD LEAD TO PREMATURE HOSE ASSEMBLY FAILURES RESULTING IN PROPERTY DAMAGE, SERIOUS INJURY OR DEATH.

Global crimp sockets, nipples and fittings

Global part numbering system

Part numbers collapse to the shortest possible number of digits:

It is assumed that a global fitting has a straight configuration unless a code is added to designate otherwise.
 e.g., 1SA8FJ8 has a straight configuration
 1SA8FJA8 has a 45° elbow configuration

Dashes and unnecessary zeros are not used.
 e.g., 1/4" is designated by "4" not "-4" or "04"
 5/8" is designated by "10" not "-10"

Global crimp sockets

Complete socket number: **1S A 8**
 Global 2-piece part number
 Wire braid construction
 A = Single wire braid
 B = Double wire braid
 Hose size*

Global material designation

Global crimp nipples, sockets and fittings standard material is zinc plated carbon steel. Items so designated in catalog are available in stainless steel.

Crimp fittings



Fittings are ordered as complete assemblies or as component parts.

Complete fitting number: **FJ9896- 20 20 S**
 Basic part number
 Pipe or port size
 Mating hose size
 Material designation suffix

Crimp socket



Complete socket number: **FC2717- 20 S**
 Basic part number
 Socket hose size
 Material designation suffix

Crimp nipple



Complete nipple number: **FC2710- 20 20 S**
 Basic part number
 Socket or port size
 Socket hose size
 Material designation suffix

Global crimp nipples/fittings

Complete nipple part number: **1S A 8 FJ A 8**
 Product group code
 1S = Global 2-piece part number
 1A = TTC fitting part number
 1B = TTC12 fitting part number
 1G = OTC Global fitting part number
 4S = 4S fitting part number for four spiral hose
 6S = 6S fitting part number for six spiral hose
 Material stock code
 If material is round stock, then this position collapses.
 A = inch hex stock (metric hex, this position collapses)
 For 1 1/4" Braided hose fittings:
 P = 1-wire braid hose socket with no hex
 R = 1-wire braid hose socket with inch hex
 T = 2-wire braid hose socket with no hex
 V = 2-wire braid hose socket with inch hex
 End connection size*
 End connection code
 BF = BSP Female Swivel (1 hex)
 BP = BSP Male Parallel
 BT = BSP Male Tapered
 CT = Cat Flange
 DK = 24 Male (light duty)
 DL = DKO Female Swivel (light duty)
 DS = DKO Female Swivel (heavy duty)
 EK = 24 Male (heavy duty)
 FH = Flange Code 62
 FJ = Female JIC Swivel
 FL = Flange Code 61
 FR = Female ORS
 FS = Female SAE Swivel
 JF = JIS Female Swivel
 JM = BSP Female Swivel (2 hexes)
 KF = Komatsu Female Swivel
 KS = Komatsu Split Flange
 MB = Male Boss O-Ring
 MF = Male Inverted Flare
 MJ = Male JIC
 MP = Male Pipe
 MR = Male ORS
 PF = Female Pipe Swivel
 PS = Pipe Swivel
 Connecting end configuration code
 If nipple has a straight configuration, then this position collapses.
 A = 45°
 B = 90°, standard or short drop
 C = 90°, long drop
 D = 22-1/2°
 E = 67-1/2°
 F = 30°
 G = 60°
 Hose size*
 Material Designation
 C = stainless steel, if fitting is zinc plated carbon steel (standard, this position collapses).

*When ordering sizes 3, 4, 5, 6 and 8 the part number requires only single digits.

Crimp fittings

Socket data

H

Socket data

TTC-



TTC12-

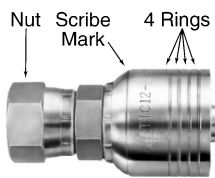

Scribe mark: For TTC and TTC12 Fittings, the scribe mark identifies crimp length indicator for assembly; See Document A-EQCR-TM001-E for details.

1G

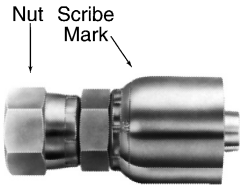

Crimp Socket data – Socket to hose correct combinations

Use of the correct Eaton socket with a given Aeroquip hose is essential for proper assembly and performance. Virtually all Eaton hose sockets are marked with the socket part number and dash size. Using this number, from the following table, the correct hose or hoses may be found and dash sizes matched, to assure the correct combination.

Global Over the cover identification (OTC sockets)

Over the cover global fitting sockets have 1G(size) and a scribe mark stamped on the socket.

1SA

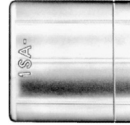

1SB



Global skive socket identification

1SA sockets are stamped 1SA(size) for one wire braid hose and 1SB sockets are stamped 1SB(size) for two wire braid hose. 1SA sockets have one ring and 1SB sockets have two rings grooved around the circumference of each socket.

Global identification marking

Global hose fittings are identified with the Eaton trademark and the hose size. In addition, global sockets are identified with the following:

Identification marking	Fitting style	Hose/Socket description
1 ring 1SA(size)	skive	One wire braid hose and skive type socket
2 rings 1SB(size)	skive	Two wire braid hose and skive type socket
2 rings 1 ring 1 scribe mark TTC–(size)	Thru-the-cover	One wire and two wire braid hose and TTC socket
4 rings 1 scribe mark TTC12–(size)	Spiral thru-the-cover	Four spiral wire hose and TTC12 socket
1 scribe mark 1G (size)	Over the cover	Textile braid and suction hoses and OTC socket (SAE 100R3, R4 and R6 hose styles)

Aeroquip hose base part no.	Dash sizes	Socket base part number	Crimp sockets
2681	–03 to –32	1SA	
FC310	–04 to –20		
FC510	–04 to –20		
FC639/FC839B	–04 to –08		
GH194	–04 to –20		
GH663	–04 to –32		
GH681	–04 to –08		
2781	–4 to –32	1SB	
FC195	–04 to –32		
FC466	–04 to –12		
FC498/FC598	–04 to –12		
FC579	–04, –06		
FC639/FC839B	–10 to –16		
FC735	–04 to –20		
FC849/FC849B	–06 to –12		
GH120	–04 to –20		
GH195	–04 to –32		
GH781	–04 to –20		
GH793	–04 to –32		
FC736	–12, –16		

Male pipe (MP)

1 Global TTC fittings

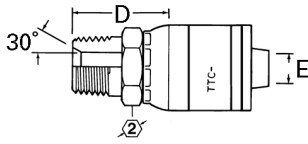

For use with hose:
2661(-12 thru -32), FC310, FC510, FC579, FC611, FC619 (-12 thru -32), FC639/FC839B, FC693, FC735, FC849 / FC849B, GH120, GH194, GH195, GH663, GH681, GH781, GH793.

2 Global nipples

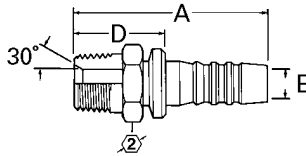

For use with hose:
Clamp: 2661 (-12 thru -20), FC619 (-12 thru -20). **Socket**
Socket 1SA: 2681, FC310, FC510, FC639/FC839B (-4 thru -8), GH194 (-4 thru -20), GH663, GH681.
Socket 1SB: 2781, FC195, FC466, FC498, FC598, FC579, FC639/FC839B (-10 thru -16), FC735 (-4 thru -20), FC849/ FC849B (-06 thru -12), GH120 (-4 thru -20), GH195, GH781 (-04 thru -20), GH793, 2766.

3 Global OTC fittings

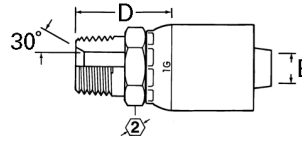

For use with hose:
2583, 2661, FC466, FC498, FC598, FC619, FC699.

4 Global TTC12 fittings

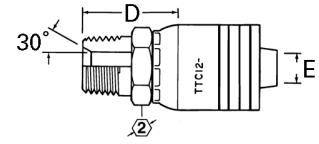

For use with hose:
FC636, FC736, GH493, EC525.

1 TTC part #	2 Nipple part #	3 OTC part #	4 TTC12 part #	Thd.	Hose size	A		D		EØ		in
						mm	in	mm	in	mm	in	
—	1SA2MP3	—	—	1/8-27	-03	40,4	1.59	22,9	0.90	2,5	0.10	7/16
—	1SA4MP3	—	—	1/4-18	-03	41,4	1.62	23,6	0.93	2,5	0.10	9/16
1AA2MP4	1SA2MP4	1GA2MP4	—	1/8-27	-04	46,7	1.84	23,4	0.92	4,3	0.17	9/16
1AA4MP4†	1SA4MP4	1GA4MP4	—	1/4-18	-04	52,3	2.06	29,0	1.14	4,3	0.17	9/16
1AA6MP4	1SA6MP4	1GA6MP4	—	3/8-18	-04	48,3	1.90	24,9	0.98	4,3	0.17	11/16
1AA4MP6	1SA4MP6	1GA4MP6	1BA4MP6 4SA4MP6*	1/4-18	-06	51,4	2.02	30,1	1.18	6,7	0.26	11/16
1AA6MP6†	1SA6MP6	1GA6MP6	1BA6MP6 4SA6MP6*	3/8-18	-06	55,0	2.17	32,2	1.27	6,7	0.26	11/16
1AA8MP4	1SA8MP4	—	—	1/2-14	-04	51,3	2.02	31,2	1.23	4,3	0.17	7/8
1AA8MP6	1SA8MP6	1GA8MP6	1BA8MP6 4SA8MP6*	1/2-14	-06	53,7	2.11	32,4	1.28	6,7	0.26	7/8
1AA4MP8	1SA4MP8	1GA4MP8	1BA4MP8 4SA4MP8*	1/4-18	-08	58,5	2.30	31,3	1.23	7,7	0.30	13/16
1AA6MP8	1SA6MP8	1GA6MP8	1BA6MP8 4SA6MP8*	3/8-18	-08	60,8	2.39	33,6	1.32	9,6	0.38	13/16
1AA8MP8†	1SA8MP8	1GA8MP8	1BA8MP8 4SA8MP8*	1/2-14	-08	71,0	2.80	40,6	1.60	9,6	0.38	7/8
1AA12MP8	1SA12MP8	1GA12MP8	1BA12MP8 4SA12MP8*	3/4-14	-08	62,6	2.46	35,4	1.39	9,6	0.38	1 1/16
1AA6MP10	1SA6MP10	—	—	3/8-18	-10	63,2	2.49	33,8	1.33	10,7	0.42	15/16
1AA8MP10	1SA8MP10	1GA8MP10	1BA8MP10 4SA8MP10*	1/2-14	-10	66,2	2.61	40,1	1.58	12,8	0.50	15/16
1AA12MP10	1SA12MP10	1GA12MP10	1BA12MP10 4SA12MP10*	3/4-14	-10	61,7	2.43	35,6	1.40	12,8	0.50	1 1/16
1AA8MP12	1SA8MP12	1GA8MP12	1BA8MP12	1/2-14	-12	70,6	2.78	40,6	1.60	14,2	0.56	1 1/8
1AA12MP12†	1SA12MP12	1GA12MP12	1BA12MP12	3/4-14	-12	72,1	2.84	41,9	1.65	15,5	0.61	1 1/8
1AA16MP12	1SA16MP12	1GA16MP12	1BA16MP12	1-11 1/2	-12	71,1	2.80	40,9	1.61	15,5	0.61	1 3/8

† Also available in stainless steel, add suffix "C" to part number, i.e., 1AA4MP4C.

* Part number denotes 4S equivalent fitting.

Crimp fittings

Braided, low pressure and four spiral
(TTC / 1SA / 1GA / TTC-12 Series)

H

Male pipe (MP) - Continued

1 Global TTC fittings

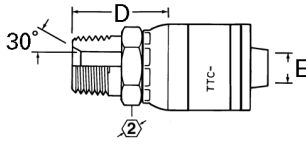

For use with hose:

2661(-12 thru -32), FC310, FC510, FC579, FC611, FC619 (-12 thru -32), FC639/FC839B, FC693, FC735, FC849/FC849B, GH120, GH194, GH195, GH663, GH681, GH781, GH793.

2 Global nipples

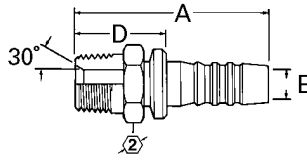

For use with hose:

Clamp: 2661 (-12 thru -20), FC619 (-12 thru -20). Socket

Socket 1SA: 2681, FC310, FC510, FC639/FC839B (-4 thru -8), GH194 (-4 thru -20), GH663, GH681.

Socket 1SB: 2781, FC195, FC466, FC498, FC598, FC579, FC639/FC839B (-10 thru -16), FC735 (-4 thru -20), FC849/FC849B (-06 thru -12), GH120 (-4 thru -20), GH195, GH781 (-04 thru -20), GH793, 2766.

3 Global OTC fittings

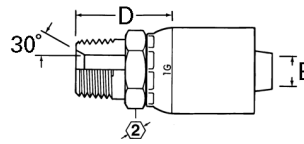

For use with hose:

2583, 2661, FC466, FC498, FC598, FC619, FC699.

4 Global TTC12 fittings

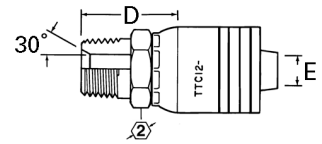

For use with hose:

FC636, FC736, GH493, EC525.

1 TTC part #	2 Nipple part #	3 OTC part #	4 TTC12 part #	Thd.	Hose size	A		D		EØ		in
						mm	in	mm	in	mm	in	
1AA12MP16	1SA12MP16	1GA12MP16	1BA12MP16	3/4-14	-16	76,7	3.02	42,4	1.67	19,3	0.76	1 3/8
1AA16MP16 †	1SA16MP16	1GA16MP16	1BA16MP16	1-11 1/2	-16	81,8	3.22	47,2	1.86	20,8	0.82	1 3/8
1AA20MP16	1SA20MP16	1GA20MP16	1BA20MP16	1 1/4-11 1/2	-16	78,2	3.08	43,7	1.72	20,8	0.82	1 11/16
1AA16MP20	1SA16MP20	1GA16MP20	1BA16MP20	1-11 1/2	-20	93,0	3.66	49,0	1.93	24,1	0.95	1 3/4
1AA20MP20 †	1SA20MP20	1GA20MP20	1BA20MP20	1 1/4-11 1/2	-20	89,4	3.52	45,5	1.79	26,7	1.05	1 13/16
1AA24MP24	1SA24MP24	1GA24MP24	1BA24MP24	1 1/2-11 1/2	-24	106,2	4.18	59,9	2.36	32,0	1.26	2
1AA32MP32	1SA32MP32	1GA32MP32	—	2-11 1/2	-32	116,6	4.59	66,3	2.61	44,5	1.75	2 1/2
—	—	—	1BA32MP32	2-11 1/2	-32	128,5	5.06	65,5	2.58	44,5	1.75	2 1/2

† Also available in stainless steel, add suffix "C" to part number, i.e., 1AA4MP4C.

Female pipe swivel (PF)

1 Global TTC fittings

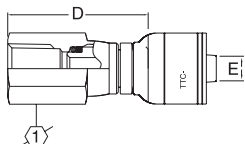

For use with hose:

2661(-12 thru -32), FC310, FC510, FC579, FC611, FC619 (-12 thru -32), FC639/FC839B, FC693, FC735, FC849/FC849B, GH120, GH194, GH195, GH663, GH681, GH781, GH793.

2 Global nipples

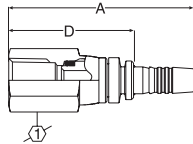

For use with hose:

Clamp: 2661 (-12 thru -20), FC619 (-12 thru -20).

Socket 1SA: 2681, FC310, FC372-03, FC510, FC639/FC839B (-4 thru -8), GH194 (-4 thru -20), GH663, GH681.

Socket 1SB: 2781, FC466, FC498, FC598, FC579, FC639/FC839B (-10 thru -16), FC735 (-4 thru -20), FC849/FC849B (-06 thru -12), GH120 (-4 thru -20), GH195, GH781 (-04 thru -20), GH793, 2766.

3 Global OTC fittings

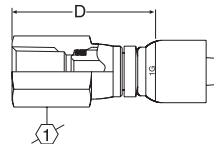

For use with hose:

2583, 2661, FC466, FC498, FC598, FC619, FC699.

4 Global TTC12 fittings

No offering

For use with hose:

FC636, FC736, GH493, EC525.

1 TTC part #	2 Nipple part #	3 OTC part #	4 TTC12 part #	Thd.	Hose size	A		D		EØ		2 in
						mm	in	mm	in	mm	in	
1AA4PF4	1SA4PF4	1GA4PF4	—	1/4-18	-04	72,9	2.87	49,5	1.95	4,3	0.17	3/4
1AA6PF6	1SA6PF6	1GA6PF6	—	3/8-18	-06	75,4	2.97	50,0	1.97	6,6	0.26	7/8
1AA8PF8	1SA8PF8	1GA8PF8	—	1/2-14	-08	90,9	3.58	61,2	2.41	9,7	0.38	1 1/16
1AA12PF12	1SA12PF12	1GA12PF12	—	3/4-14	-12	92,2	3.63	62,0	2.44	15,5	0.61	1 3/8
1AA16PF16	1SA16PF16	—	—	1-11 1/2	-16	111,0	4.37	77,5	3.05	20,6	0.81	1 5/8

Crimp fittings

Braided, low pressure and four spiral
(TTC / 1SA / 1GA / TTC-12 Series)

H

Male pipe swivel (PS)

1 Global nipples

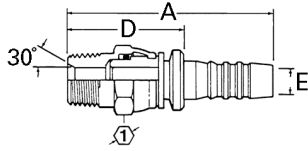

2 Global OTC fittings

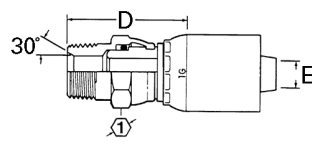

3 Global TTC fittings

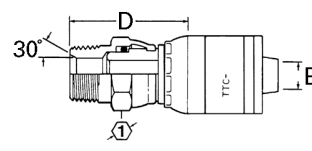

4 Global TTC12 fittings

No offering

1 TTC part #	2 Nipple part #	3 OTC part #	4 TTC12 part #	Thd.	Hose size	A		D		EØ		② in
						mm	in	mm	in	mm	in	
—	1SA2PS3	—	—	1/8-27	-03	53,6	2.11	36,1	1.42	2,5	0.10	9/16
1AA4PS4	1SA4PS4	1GA4PS4	—	1/4-18	-04	64,5	2.54	41,4	1.62	4,3	0.17	3/4
1AA4PS6	1SA4PS6	—	—	1/4-18	-06	63,5	2.54	42,4	1.67	6,6	0.26	3/4
1AA6PS6	1SA6PS6	1GA6PS6	—	3/8-18	-06	67,6	2.66	42,4	1.67	6,6	0.26	7/8
1AA8PS6	1SA8PS6	1GA8PS6	—	1/2-14	-06	72,4	2.85	47,0	1.85	6,6	0.26	7/8
1AA6PS8	1SA6PS8	1GA6PS8	—	3/8-18	-08	73,2	2.88	43,4	1.71	9,7	0.38	7/8
1AA8PS8	1SA8PS8	1GA8PS8	—	1/2-14	-08	79,5	3.13	49,8	1.96	9,7	0.38	15/16
1AA12PS12	1SA12PS12	1GA12PS12	—	3/4-14	-12	82,3	3.24	52,1	2.05	15,5	0.61	1 3/8
1AA16PS16	1SA16PS16	1GA16PS16	—	1-11 1/2	-16	98,6	3.88	64,3	2.53	20,6	0.81	1 1/2

Female JIC/SAE 37° swivel (FJ)

1 Global TTC fittings

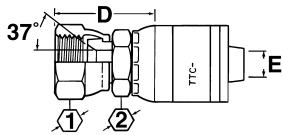

For use with hose:

2661(-12 thru -32), FC310, FC510, FC579, FC611, FC619 (-12 thru -32), FC639/FC839B, FC693, FC735, FC849/FC849B, GH120, GH194, GH195, GH663, GH681, GH781, GH793.

2 Global nipples

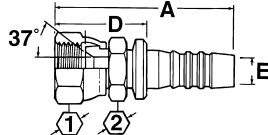

For use with hose:

Clamp: 2661 (-12 thru -20), FC619 (-12 thru -20).

Socket 1SA: 2681, FC310, FC510, FC639/FC839B (-4 thru -8), GH194 (-4 thru -20), GH663, GH681.

Socket 1SB: 2781, FC195, FC466, FC498, FC598, FC579, FC639/FC839B (-10 thru -16), FC735 (-4 thru -20), FC849/FC849B (-06 thru -12), GH120 (-4 thru -20), GH195, GH781 (-04 thru -20), GH793, 2766.

3 Global OTC fittings

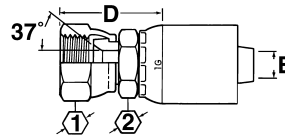

For use with hose:

2583, 2661, FC466, FC498, FC598, FC619, FC699.

4 Global TTC12 fittings

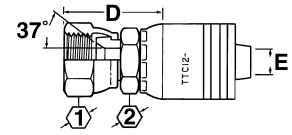

For use with hose:

FC636, FC736, GH493, EC525.

1 TTC part #	2 Nipple part #	3 OTC part #	4 TTC12 part #	Thd.	Hose size	A		D		EØ		1	2
						mm	in	mm	in	mm	in		
—	1SA3FJ3	—	—	3/8-24	-03	42,3	1.69	25,4	1.00	2,5	0.10	1/2	7/16
—	1SA4FJ3	—	—	7/16-20	-03	42,3	1.69	25,4	1.00	2,5	0.10	9/16	7/16
1AA3FJ4	1SA3FJ4	1GA3FJ4	—	3/8-24	-04	49,3	1.94	25,9	1.02	3,3	0.13	1/2	9/16
1AA4FJ4 †	1SA4FJ4	1GA4FJ4	—	7/16-20	-04	50,8	2.00	26,8	1.05	4,2	0.17	9/16	9/16
1AA5FJ4	1SA5FJ4	1GA5FJ4	—	1/2-20	-04	50,3	1.98	28,9	1.14	4,2	0.17	5/8	9/16
1AA6FJ4	1SA6FJ4	1GA6FJ4	—	9/16-18	-04	51,6	2.03	28,2	1.11	4,3	0.17	1 1/16	9/16
1AA5FJ5	1SA5FJ5	1GA5FJ5	—	1/2-20	-05	52,8	2.08	29,0	1.14	5,3	0.21	5/8	9/16
1AA6FJ5	1SA6FJ5	1GA6FJ5	—	9/16-18	-05	52,3	2.06	28,4	1.12	5,3	0.21	1 1/16	9/16
1AA4FJ6	1SA4FJ6	1GA4FJ6	1BA4FJ6 4SA4FJ6*	7/16-20	-06	55,6	2.19	30,2	1.19	4,3	0.17	9/16	11/16
1AA5FJ6	1SA5FJ6	1GA5FJ6	—	1/2-20	-06	56,9	2.24	31,5	1.24	5,8	0.23	5/8	11/16
1AA6FJ6 †	1SA6FJ6	1GA6FJ6	1BA6FJ6 4SA6FJ6*	9/16-18	-06	57,9	2.28	32,5	1.28	6,6	0.26	1 1/16	11/16
1AA8FJ6	1SA8FJ6	1GA8FJ6	1BA8FJ6 4SA8FJ6*	3/4-16	-06	58,7	2.31	33,3	1.31	6,6	0.26	7/8	11/16
1AA10FJ6	1SA10FJ6	—	—	7/8-14	-06	57,4	2.26	13,2	0.52	6,6	0.26	1	11/16
1AA6FJ8	1SA6FJ8	—	1BA6FJ8 4SA6FJ8*	9/16-18	-08	59,9	2.36	34,5	1.36	9,6	0.33	11/16	13/16
—	1SA10FJ6	—	—	7/8-14	-06	61,5	2.42	36,3	1.43	6,6	0.26	1	13/16
1AA8FJ8 †	1SA8FJ8	1GA8FJ8	1BA8FJ8 4SA8FJ8*	3/4-16	-08	66,8	2.63	37,1	1.46	9,7	0.38	7/8	13/16
1AA10FJ8	1SA10FJ8	1GA10FJ8	1BA10FJ8 4SA10FJ8*	7/8-14	-08	67,1	2.64	37,3	1.47	9,7	0.38	1	7/8
1AA12FJ8	1SA12FJ8	1GA12FJ8	1BA12FJ8 4SA12FJ8*	1 1/16-12	-08	69,3	2.73	39,6	1.56	9,7	0.38	1 1/4	1
1AA16FJ8	1SA16FJ8	1GA16FJ8	1BA16FJ8	1 5/16-12	-08	77,7	3.06	48,0	1.89	9,7	0.38	1 1/2	1 1/4
1AA8FJ10	1SA8FJ10	—	—	3/4-16	-10	67,3	2.65	38,1	1.50	9,9	0.39	7/8	15/16
1AA10FJ10 †	1SA10FJ10	1GA10FJ10	1BA10FJ10 4SA10FJ10*	7/8-14	-10	70,4	2.77	41,1	1.62	12,7	0.50	1	15/16
1AA12FJ10	1SA12FJ10	1GA12FJ10	1BA12FJ10 4SA12FJ10*	1 1/16-12	-10	69,1	2.72	39,9	1.57	12,7	0.50	1 1/4	1

† Also available in stainless steel, add suffix "C" to part number, i.e., 1AA4FJ4C.

* Part number denotes 4S equivalent fitting.

Crimp fittings

Braided, low pressure and four spiral
(TTC / 1SA / 1GA / TTC-12 Series)

H

Female JIC/SAE 37° swivel (FJ)

1 Global TTC fittings

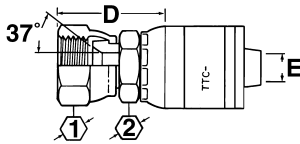

For use with hose:

2661(-12 thru -32), FC310, FC510, FC579, FC611, FC619 (-12 thru -32), FC639/FC839B, FC693, FC735, FC849/FC849B, GH120, GH194, GH195, GH663, GH681, GH781, GH793.

2 Global nipples

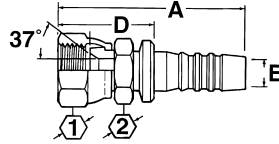

For use with hose:

Clamp: 2661 (-12 thru -20), FC619 (-12 thru -20).

Socket 1SA: 2681, FC310, FC510, FC639/FC839B (-4 thru -8), GH194 (-4 thru -20), GH663, GH681.

Socket 1SB: 2781, FC195, FC466, FC498, FC598, FC579, FC639/FC839B (-10 thru -16), FC735 (-4 thru -20), FC849/FC849B (-06 thru -12), GH120 (-4 thru -20), GH195, GH781 (-04 thru -20), GH793, 2766.

3 Global OTC fittings

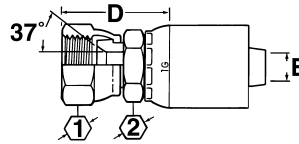

For use with hose:

2583, 2661, FC466, FC498, FC598, FC619, FC699.

4 Global TTC12 fittings

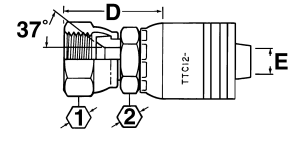

For use with hose:

FC636, FC736, GH493, EC525.

1 TTC part #	2 Nipple part #	3 OTC part #	4 TTC12 part #	Thd.	Hose size	A		D		EØ		1	2
						mm	in	mm	in	mm	in		
1AA10FJ12	1SA10FJ12	1GA10FJ12	1BA10FJ12	7/8-14	-12	71,4	2.81	41,4	1.63	12,2	0.48	1	1 1/8
1AA12FJ12 †	1SA12FJ12	1GA12FJ12	1BA12FJ12	1 1/16-12	-12	72,1	2.84	41,9	1.65	15,5	0.61	1 1/4	1 1/8
1AA14FJ12	1SA14FJ12	1GA14FJ12	1BA14FJ12	1 3/16-12	-12	72,1	2.84	42,6	1.68	15,5	0.61	1 3/8	1 1/8
1AA16FJ12	1SA16FJ12	1GA16FJ12	1BA16FJ12	1 5/16-12	-12	73,9	2.91	43,7	1.72	15,5	0.61	1 1/2	1 1/4
1AA12FJ16	1SA12FJ16	1GA12FJ16	1BA12FJ16	1 1/16-12	-16	80,0	3.15	45,7	1.80	15,5	0.61	1 1/4	1 3/8
1AA14FJ16	1SA14FJ16	—	—	1 3/16-12	-16	80,0	3.15	46,5	1.83	20,6	0.81	1 3/8	1 3/8
1AA16FJ16 †	1SA16FJ16	1GA16FJ16	1BA16FJ16	1 5/16-12	-16	83,6	3.29	49,0	1.93	20,6	0.81	1 1/2	1 3/8
1AA20FJ16	1SA20FJ16	1GA20FJ16	1BA20FJ16	1 5/8-12	-16	80,5	3.17	46,0	1.81	20,6	0.81	2	—
1AA16FJ20	1SA16FJ20	1GA16FJ20	1BA16FJ20	1 5/16-12	-20	87,9	3.46	43,9	1.73	21,6	0.85	1 1/2	—
1AA20FJ20 †	1SA20FJ20	1GA20FJ20	1BA20FJ20	1 5/8-12	-20	91,7	3.61	47,8	1.88	26,7	1.05	2	—
—	1SA24FJ20	—	1BA24FJ20	1 7/8-12	-20	95,5	3.76	51,6	2.03	26,7	1.05	2 1/4	—
1AA24FJ24	1SA24FJ24	1GA24FJ24	1BA24FJ24	1 7/8-12	-24	99,1	3.90	52,6	2.07	32,0	1.26	2 1/4	—
1AA24FJ32	1SA24FJ32	1GA24FJ32	—	1 7/8-12	-32	103,9	4.09	53,8	2.12	33,3	1.31	2 1/4	—
1AA32FJ32	1SA32FJ32	1GA32FJ32	—	2 1/2-12	-32	110,2	4.34	60,7	2.39	44,5	1.75	2 7/8	—
—	—	—	1BA32FJ32	2 1/2-12	-32	122,4	4.82	59,2	2.33	44,5	1.75	2 7/8	—

† Also available in stainless steel, add suffix "C" to part number, i.e., 1AA4FJ4C.

Female JIC/SAE 37° swivel 45° elbow (FJA)

1 Global TTC fittings

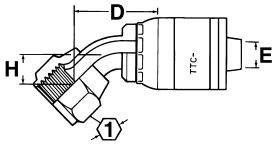

For use with hose:

2661(-12 thru -32), FC310, FC510, FC579, FC611, FC619 (-12 thru -32), FC639/FC839B, FC693, FC735, FC849/FC849B, GH120, GH194, GH195, GH663, GH681, GH781, GH793.

2 Global nipples

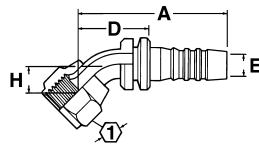

For use with hose:

Clamp: 2661 (-12 thru -20), FC619 (-12 thru -20).

Socket 1SA: 2681, FC310, FC510, FC639/FC839B (-4 thru -8), GH194 (-4 thru -20), GH663, GH681.

Socket 1SB: 2781, FC466, FC195, FC498, FC598, FC579, FC639/FC839B (-10 thru -16), FC735 (-4 thru -20), FC849/FC849B (-06 thru -12), GH120 (-4 thru -20), GH195, GH781 (-04 thru -20), GH793, 2766.

3 Global OTC fittings

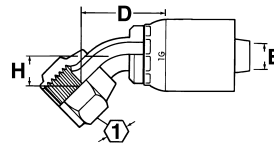

For use with hose:

2583, 2661, FC466, FC498, FC598, FC619, FC699.

4 Global TTC12 fittings

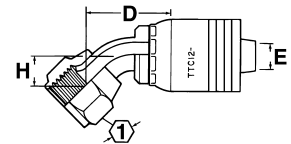

For use with hose:

FC636, FC736, GH493, EC525.

1 TTC part #	2 Nipple part #	3 OTC part #	4 TTC12 part #	Thd.	Hose size	A		D		EØ		H		① in
						mm	in	mm	in	mm	in	mm	in	
1AA4FJA4 †	1SA4FJA4 †	1GA4FJA4 †	—	7/16-20	-04	45,1	1.78	24,6	0.97	4,2	0.17	8,4	0.33	9/16
1AA5FJA4 †	1SA5FJA4 †	1GA5FJA4 †	—	1/2-20	-04	51,8	2.04	28,4	1.12	4,3	0.17	9,4	0.37	5/8
1AA6FJA4	1SA6FJA4	1GA6FJA4	—	9/16-18	-04	53,1	2.09	29,7	1.17	4,3	0.17	9,9	0.39	11/16
1AA4FJA6	1SA4FJA6	—	—	7/16-20	-06	44,5	1.75	23,4	0.92	4,1	0.16	8,4	0.33	9/16
1AA6FJA6	1SA6FJA6	1GA6FJA6	—	9/16-18	-06	58,7	2.31	33,3	1.31	6,1	0.24	9,9	0.39	11/16
—	—	—	1BA6FJA6 4SA6FJA6*	9/16-18	-06	56,5	2.22	33,3	1.31	6,2	0.24	9,9	0.39	11/16
1AA8FJA6 †	1SA8FJA6 †	1GA8FJA6 †	—	3/4-16	-06	67,3	2.65	42,2	1.66	6,6	0.26	14,0	0.55	7/8
—	—	—	1BA8FJA6 4SA8FJA6*	3/4-16	-06	75,6	2.98	54,3	2.14	6,7	0.26	24,2	0.95	7/8
1AA8FJA8 †	1SA8FJA8 †	1GA8FJA8 †	—	3/4-16	-08	71,6	2.82	41,9	1.65	9,4	0.37	14,0	0.55	7/8
—	—	—	1BA8FJA8 4SA8FJA8*	3/4-16	-08	72,9	2.87	42,7	1.65	9,4	0.37	14,0	0.55	7/8
1AA10FJA8 †	1SA10FJA8 †	1GA10FJA8 †	—	7/8-14	-08	77,0	3.03	47,2	1.86	9,7	0.38	15,0	0.59	1
—	—	—	1BA10FJA8 4SA10FJA8*	7/8-14	-08	82,5	3.25	55,3	2.18	9,4	0.37	25,3	1.00	1
1AA10FJA10 †	1SA10FJA10 †	1GA10FJA10 †	1BA10FJA10 4SA10FJA10*	7/8-14	-10	71,6	2.82	45,4	1.79	11,7	0.46	16,0	0.63	1
1AA12FJA10	1SA12FJA10	1GA12FJA10	—	1 1/16-12	-10	85,9	3.38	56,4	2.22	12,7	0.50	19,8	0.78	1 1/4
—	—	—	1BA12FJA10 4SA12FJA10*	1 1/16-12	-10	92,6	3.65	66,5	2.62	12,8	0.50	29,4	1.16	1 1/4
1AA12FJA12	1SA12FJA12	1GA12FJA12	—	1 1/16-12	-12	87,1	3.43	56,9	2.24	14,7	0.58	19,8	0.78	1 1/4
1AA16FJA12	1SA16FJA12	—	—	1 5/16-12	-16	95,0	3.74	60,7	2.39	19,3	0.76	27,2	1.07	1 1/2
—	—	—	1BA12FJA12	1 1/16-12	-12	96,8	3.81	66,5	2.62	14,2	0.56	29,5	1.16	1 1/4
1AA20FJA16	1SA20FJA16	1GA20FJA16	—	1 5/8-12	-16	101,6	4.00	67,3	2.65	20,6	0.81	31,0	1.22	2
1AA16FJA16	1SA16FJA16	1GA16FJA16	—	1 5/16-12	-16	95,0	3.74	76,4	3.01	20,6	0.81	27,1	1.07	1 1/2
—	—	—	1BA16FJA16	1 5/16-12	-16	119,6	4.71	85,3	3.36	19,3	0.76	38,9	1.53	1 1/2
1AA20FJA20	1SA20FJA20	1GA20FJA20	—	1 5/8-12	-20	112,8	4.44	68,8	2.71	25,7	1.01	31,0	1.22	2
—	—	—	1BA20FJA20	1 5/8-12	-20	138,4	5.45	94,5	3.72	25,7	1.01	43,2	1.70	2
—	—	—	1BA24FJA24	1 7/8-12	-24	159,3	6.27	112,8	4.44	30,2	1.19	50,5	1.99	2 1/4

† Swivel nuts are universal for both SAE 37° and SAE 45° connections.
* Part number denotes 4S equivalent fitting.

Crimp fittings

Braided, low pressure and four spiral
(TTC / 1SA / 1GA / TTC-12 Series)

H

Female JIC/SAE 37° swivel 90° elbow (FJB)

1 Global TTC fittings

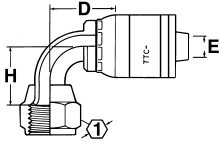

For use with hose:
2661(-12 thru -32), FC310, FC510, FC579, FC611, FC619 (-12 thru -32), FC639/FC839B, FC693, FC735, FC849/FC849B, GH120, GH194, GH195, GH663, GH681, GH781, GH793.

2 Global nipples

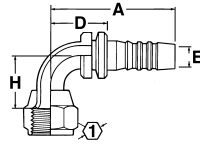

For use with hose:
Clamp: 2661 (-12 thru -20), FC619 (-12 thru -20).
Socket 1SA: 2681, FC310, FC510, FC639/FC839B (-4 thru -8), GH194 (-4 thru -20), GH663, GH681.
Socket 1SB: 2781, FC195, FC466, FC498, FC598, FC579, FC639/FC839B (-10 thru -16), FC735 (-4 thru -20), FC849/FC849B (-06 thru -12), GH120 (-4 thru -20), GH195, GH781 (-04 thru -20), GH793, 2766.

3 Global OTC fittings

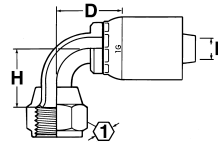

For use with hose:
2583, 2661, FC466, FC498, FC598, FC619, FC699.

4 Global TTC12 fittings

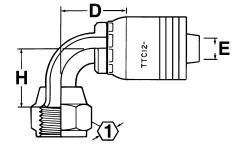

For use with hose:
C636, FC736, GH493, EC525.

1 TTC part #	2 Nipple part #	3 OTC part #	4 TTC12 part #	Thd.	Hose size	A		D		EØ		H		in
						mm	in	mm	in	mm	in	mm	in	
—	1SA4FJB3†	—	—	7/16-20	-03	40,6	1.60	23,1	0.91	2,5	0.10	17,3	0.68	9/16
1AA4FJB4†	1SA4FJB4†	1GA4FJB4†	—	7/16-20	-04	46,7	1.84	23,3	0.92	4,2	0.17	17,3	0.68	9/16
1AA5FJB4†	1SA5FJB4†	1GA5FJB4†	—	1/2-20	-04	48,8	1.92	25,4	1.00	4,3	0.17	19,3	0.76	5/8
1AA6FJB4	1SA6FJB4	1GA6FJB4	—	9/16-18	-04	50,8	2.00	25,1	0.99	4,2	0.17	22,9	0.90	11/16
—	1SA5FJB5†	—	—	1/2-20	-05	49,5	1.95	25,7	1.01	4,6	0.18	19,3	0.76	5/8
1AA4FJB6	—	—	—	7/16-20	-06	46,0	1.81	24,9	0.98	4,1	0.16	17,3	0.68	9/16
1AA6FJB6	1SA6FJB6	1GA6FJB6	—	9/16-18	-06	56,1	2.21	31,0	1.22	6,1	0.24	21,3	0.84	11/16
—	—	—	1BA6FJB6 4SA6FJB6*	9/16-18	-06	54,1	2.13	30,9	1.22	6,2	0.24	21,6	0.85	11/16
1AA8FJB6†	1SA8FJB6†	1GA8FJB6†	—	3/4-16	-06	61,5	2.42	36,1	1.42	6,6	0.26	27,7	1.09	7/8
—	—	—	1BA8FJB6 4SA8FJB6*	3/4-16	-08	64,7	2.55	43,4	1.71	6,7	0.26	47,4	1.87	7/8
1AA6FJB8	1SA6FJB8	1GA6FJB8	—	9/16-18	-08	61,7	2.43	32,0	1.26	6,1	0.24	21,3	0.84	11/16
1AA8FJB8†	1SA8FJB8†	1GA8FJB8†	—	3/4-16	-08	65,8	2.59	36,1	1.42	9,4	0.37	27,7	1.09	7/8
—	—	—	1BA8FJB8 4SA8FJB8*	3/4-16	-08	67,1	2.64	36,7	1.42	9,4	0.37	27,7	1.09	7/8
1AA10FJB8†	1SA10FJB8†	1GA10FJB8†	—	7/8-14	-08	70,6	2.78	41,0	1.61	9,7	0.38	30,2	1.19	1
—	—	—	1BA10FJB8 4SA10FJB8*	7/8-14	-08	70,5	2.78	43,3	1.70	9,4	0.37	49,0	1.93	1
1AA10FJB10†	1SA10FJB10†	1GA10FJB10†	1BA10FJB10 4SA10FJB10*	7/8-14	-10	70,2	2.76	39,3	1.55	11,7	0.46	31,2	1.23	1
1AA10FJB12	1SA10FJB12	—	—	7/8-14	-12	65,3	2.57	39,6	1.56	11,7	0.46	30,2	1.19	1
—	1SA12FJB8	—	—	1 1/16-12	-08	86,1	3.39	56,4	2.22	9,7	0.38	45,7	1.80	1 1/4
1AA12FJB10	1SA12FJB10	1GA12FJB10	—	1 1/16-12	-10	84,1	3.31	54,9	2.16	12,7	0.50	45,7	1.80	1 1/4
—	—	—	1BA12FJB10 4SA12FJB10*	1 1/16-12	-10	84,8	3.34	55,4	2.18	12,7	0.50	69,7	2.35	1 1/4
1AA20FJB16	1SA20FJB16	—	—	1 5/8-12	-16	95,8	3.77	62,2	2.45	20,8	0.82	69,9	2.75	2

† Swivel nuts are universal for both SAE 37° and SAE 45° connections.
* Part number denotes 4S equivalent fitting

Female JIC/SAE 37° swivel 90° elbow (FJB) - Cont.

1 Global TTC fittings

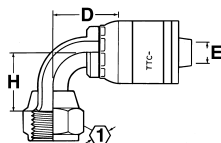

For use with hose:

2661(-12 thru -32), FC310, FC510, FC579, FC611, FC619 (-12 thru -32), FC639/FC839B, FC693, FC735, FC849/FC849B, GH120, GH194, GH195, GH663, GH681, GH781, GH793.

2 Global nipples

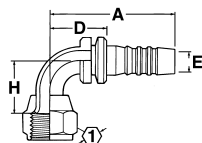

For use with hose:

Clamp: 2661 (-12 thru -20), FC619 (-12 thru -20).

Socket 1SA: 2681, FC310, FC510, FC639/FC839B (-4 thru -8), GH194 (-4 thru -20), GH663, GH681.

Socket 1SB: 2781, FC195, FC466, FC498, FC598, FC579, FC639/FC839B (-10 thru -16), FC735 (-4 thru -20), FC849/FC849B (-06 thru -12), GH120 (-4 thru -20), GH195, GH781 (-04 thru -20), GH793, 2766.

3 Global OTC fittings

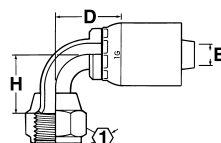

For use with hose:

2583, 2661, FC466, FC498, FC598, FC619, FC699.

4 Global TTC12 fittings

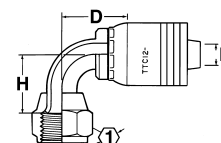

For use with hose:

FC636, FC736, GH493, EC525.

1 TTC part #	2 Nipple part #	3 OTC part #	4 TTC12 part #	Thd.	Hose size	A		D		EØ		H		1 in
						mm	in	mm	in	mm	in	mm	in	
1AA12FJB12	1SA12FJB12	1GA12FJB12	—	1 1/16-12	-12	85,4	3.36	55,1	2.17	17,4	0.58	45,7	1.82	1 1/4
—	—	—	1BA12FJB12	1 1/16-12	-12	85,6	3.37	55,4	2.18	14,2	0.56	69,7	2.35	1 1/4
1AA16FJB12	1SA16FJB12	1GA16FJB12	—	1 5/16-12	-12	85,6	3.37	55,4	2.18	15,5	0.61	60,7	2.39	1 1/2
—	—	—	1BA16FJB12	1 5/16-12	-12	85,6	3.37	55,4	2.18	14,2	0.56	62,5	2.46	1 1/2
1AA16FJB16	1SA16FJB16	1GA16FJB16	—	1 5/16-12	-16	90,4	3.56	72,9	2.87	20,6	0.81	60,7	2.39	1 1/2
—	—	—	1BA16FJB16	1 5/16-12	-16	103,1	4.06	68,6	2.70	19,3	0.76	77,2	3.04	1 1/2
—	1SA16FJB20	—	—	1 5/16-12	-20	101,6	4.00	57,7	2.27	19,3	0.76	60,7	2.39	1 1/2
1AA20FJB20	1SA20FJB20	1GA20FJB20	—	1 5/8-12	-20	108,0	4.25	64,0	2.52	25,7	1.01	69,9	2.75	2
—	—	—	1BA20FJB20	1 5/8-12	-20	120,7	4.75	76,7	3.02	25,7	1.01	86,4	3.40	2
—	—	—	1BA24FJB24	1 7/8-12	-24	137,2	5.40	90,9	3.58	30,2	1.19	100,3	3.95	2 1/4
1AA24FJB24	1SA24FJB24	—	—	1 7/8-12	-24	117,6	4.63	71,4	2.81	32,0	1.26	80,5	3.17	2 1/4

† Swivel nuts are universal for both SAE 37° and SAE 45° connections.

Crimp fittings

Braided, low pressure and four spiral
(TTC / 1SA / 1GA / TTC-12 Series)

H

Female JIC/SAE 37° swivel 90° long drop elbow (FJC)

1 Global TTC fittings

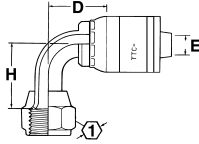

For use with hose:
2661(-12 thru -32), FC310, FC510, FC579, FC611, FC619 (-12 thru -32), FC639/FC839B, FC693, FC735, FC849/FC849B, GH120, GH194, GH195, GH663, GH681, GH781, GH793.

2 Global nipples

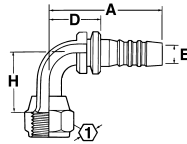

For use with hose:
Clamp: 2661 (-12 thru -20), FC619 (-12 thru -20).

Socket 1SA: 2681, FC310, FC510, FC639/FC839B (-4 thru -8), GH194 (-4 thru -20), GH663, GH681.

Socket 1SB: 2781, FC466, FC195, FC498, FC598, FC579, FC639/FC839B (-10 thru -16), FC735 (-4 thru -20), FC849/FC849B (-06 thru -12), GH120 (-4 thru -20), GH195, GH781 (-04 thru -20), GH793, 2766.

3 Global OTC fitting

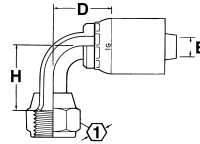

For use with hose:
2583, 2661, FC466, FC498, FC598, FC619, FC699.

4 Global TTC12 fittings

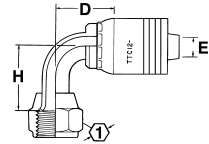

For use with hose:
FC636, FC736, GH493, EC525.

1 TTC part #	2 Nipple part #	3 OTC part #	4 TTC12 part #	Thd.	Hose size	A		D		EØ		H		① in
						mm	in	mm	in	mm	in	mm	in	
1AA4FJC4 †	1SA4FJC4 †	1GA4FJC4 †	—	7/16-20	-04	46,7	1.84	23,3	0.92	4,2	0.17	45,7	1.80	9/16
1AA5FJC4 †	1SA5FJC4 †	1GA5FJC4 †	—	1/2-20	-04	48,8	1.92	25,4	1.00	4,3	0.17	45,7	1.80	5/8
—	1SA6FJC4	—	—	9/16-18	-04	45,5	1.79	22,1	0.87	4,3	0.17	55,4	2.18	11/16
1AA4FJC6	1SA4FJC6	—	—	7/16-20	-06	46,0	1.81	24,9	0.98	4,3	0.17	45,7	1.80	9/16
1AA6FJC6	1SA6FJC6	1GA6FJC6	—	9/16-18	-06	56,4	2.22	31,2	1.23	6,1	0.24	55,4	2.18	11/16
—	—	—	1BA6FJC6 4SA6FJC6*	9/16-18	-06	54,1	2.13	30,9	1.22	6,2	0.24	55,4	2.18	11/16
1AA8FJC6 †	1SA8FJC6 †	—	—	3/4-16	-06	64,5	2.54	39,1	1.54	6,6	0.26	62,2	2.45	7/8
1AA8FJC8 †	1SA8FJC8 †	1GA8FJC8 †	—	3/4-16	-08	68,8	2.71	39,1	1.54	9,4	0.37	62,2	2.45	7/8
—	—	—	1BA8FJC8	3/4-16	-08	72,9	2.87	43,2	1.54	9,4	0.37	84,6	2.45	7/8
1AA10FJC8 †	1SA10FJC8 †	1GA10FJC8 †	—	7/8-14	-08	70,6	2.78	40,9	1.61	9,7	0.38	65,3	2.57	1
—	—	—	1BA10FJC8 4SA10FJC8*	7/8-14	-08	70,5	2.78	43,3	1.70	9,4	0.37	86,2	3.39	1
1AA10FJC10	1SA10FJC10	—	—	7/8-14	-10	68,6	2.70	39,1	1.54	11,7	0.46	65,3	2.57	1
1AA12FJC12**	1SA12FJC12	1GA12FJC12	—	1 1/16-12	-12	85,3	3.36	51,8	2.04	14,7	0.58	94,0	3.76	1 1/4
—	—	—	1BA12FJC12	1 1/16-12	-12	85,6	3.37	55,4	2.18	14,2	0.56	112,0	4.41	1 1/4
1AA16FJC16***	1SA16FJC16	1GA16FJC16	—	1 5/16-12	-16	90,4	3.56	72,9	2.87	20,6	0.81	116,4	4.58	1 1/2
—	—	—	1BA16FJC16	1 5/16-12	-16	103,1	4.06	68,6	2.70	19,3	0.76	133,1	5.24	1 1/2
1AA20FJC20	1SA20FJC20	1GA20FJC20	—	1 5/8-12	-20	108,0	4.25	64,0	2.52	25,7	1.01	140,5	5.53	2
—	—	—	1BA20FJC20	1 5/8-12	-20	120,7	4.75	76,7	3.02	25,7	1.01	150,9	5.94	2

† Swivel nuts are universal for both SAE 37° and SAE 45° connections.

* Part number denotes 4S equivalent fitting.

** The 90° long drop tube elbow configuration meets a 3.5:1 burst, based on 4000psi operating pressure.

*** The 90° long drop tube elbow configuration meets a 3.7:1 burst, based on 3000psi operating pressure.

Male JIC/SAE 37° (MJ)

1 Global TTC fittings

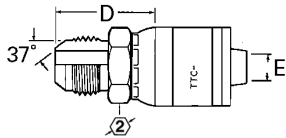

For use with hose:
2661(-12 thru -32), FC310, FC510, FC579, FC611, FC619 (-12 thru -32), FC639/FC839B, FC693, FC735, FC849/FC849B, GH120, GH194, GH195, GH663, GH681, GH781, GH793.

2 Global nipples

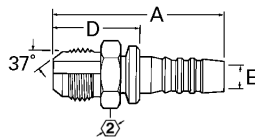

For use with hose:
Clamp: 2661 (-12 thru -20), FC619 (-12 thru -20).
Socket 1SA: 2681, FC310, FC510, FC639/FC839B (-4 thru -8), GH194 (-4 thru -20), GH663, GH681.
Socket 1SB: 2781, FC466, FC195, FC498, FC598, FC579, FC639/FC839B (-10 thru -16), FC735 (-4 thru -20), FC849/FC849B (-06 thru -12), GH120 (-4 thru -20), GH195, GH781 (-04 thru -20), GH793, 2766.

3 Global OTC fittings

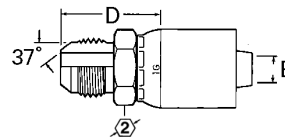

For use with hose:
2583, 2661, FC466, FC498, FC598, FC619, FC699.

4 Global TTC12 fittings

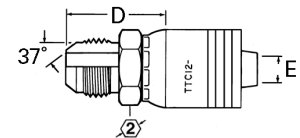

For use with hose:
FC636, FC736, GH493, EC525.

1 TTC part #	2 Nipple part #	3 OTC part #	4 TTC12 part #	Thd.	Hose size	A		D		EØ		① in
						mm	in	mm	in	mm	in	
1AA4MJ4	1SA4MJ4	1GA4MJ4	—	7/16-20	-04	50,8	2.00	27,2	1.07	4,3	0.17	9/16
1AA5MJ4	1SA5MJ4	1GA5MJ4	—	1/2-20	-04	46,7	1.84	23,4	0.92	4,3	0.17	9/16
1AA6MJ4	1SA6MJ4	1GA6MJ4	—	9/16-18	-04	47,0	1.85	23,6	0.93	4,3	0.17	5/8
—	1SA5MJ5	—	—	1/2-20	-05	52,6	2.07	28,4	1.12	5,3	0.21	9/16
1AA6MJ5	1SA6MJ5	1GA6MJ5	—	9/16-18	-05	47,8	1.88	23,9	0.94	5,3	0.21	15/8
1AA6MJ6	1SA6MJ6	1GA6MJ6	1BA6MJ6 4SA6MJ6*	9/16-18	-06	53,7	2.12	31,0	1.22	6,7	0.26	11/16
1AA8MJ6	1SA8MJ6	1GA8MJ6	1BA8MJ6 4SA8MJ6*	3/4-16	-06	49,4	1.94	28,1	1.11	6,7	0.26	13/16
1AA8MJ8	1SA8MJ8	1GA8MJ8	1BA8MJ8 4SA8MJ8*	3/4-16	-08	65,8	2.59	35,5	1.40	9,6	0.38	13/16
1AA10MJ6	1SA10MJ6	—	—	7/8-14	-06	53,3	2.10	30,7	1.21	6,6	0.26	15/16
1AA10MJ8	1SA10MJ8	1GA10MJ8	1BA10MJ8 4SA10MJ8*	7/8-14	-08	59,1	2.33	31,9	1.26	9,6	0.38	15/16
1AA12MJ8	1SA12MJ8	1GA12MJ8	1BA12MJ8 4SA12MJ8*	1 1/16-12	-08	63,4	2.50	36,2	1.43	9,7	0.38	1 1/8
1AA8MJ10	1SA8MJ10	—	—	3/4-16	-10	61,7	2.43	35,8	1.41	12,7	0.50	15/16
1AA10MJ10	1SA10MJ10	1GA10MJ10	1BA10MJ10 4SA10MJ10*	7/8-14	-10	69,4	2.73	40,5	1.59	12,3	0.48	15/16
1AA12MJ10	1SA12MJ10	1GA12MJ10	1BA12MJ10 4SA12MJ10*	1 1/16-12	-10	62,4	2.46	36,4	1.43	12,8	0.50	1 1/8
1AA10MJ12	1SA10MJ12	1GA10MJ12	1BA10MJ12	7/8-14	-12	70,6	2.78	40,4	1.59	12,2	0.48	1 1/8
1AA12MJ12	1SA12MJ12	1GA12MJ12	1BA12MJ12	1 1/16-12	-12	74,7	2.94	43,9	1.73	15,5	0.61	1 1/8
1AA14MJ12	1SA14MJ12	1GA14MJ12	1BA14MJ12	1 3/16-12	-12	69,3	2.73	39,1	1.54	15,5	0.61	1 1/4
1AA16MJ12	1SA16MJ12	1GA16MJ12	1BA16MJ12	1 5/16-12	-12	69,9	2.75	39,6	1.56	15,5	0.61	1 3/8
1AA14MJ16	1SA14MJ16	—	—	1 3/16-12	-16	79,0	3.11	45,7	1.80	18,3	0.72	1 3/8
1AA16MJ16	1SA16MJ16	1GA16MJ16	1BA16MJ16	1 5/16-12	-16	82,6	3.25	47,5	1.88	20,8	0.82	1 3/8
1AA20MJ16	1SA20MJ16	—	—	1 5/8-12	-16	77,0	3.03	43,4	1.71	20,6	0.81	1 11/16
1AA20MJ20	1SA20MJ20	1GA20MJ20	1BA20MJ20	1 5/8-12	-20	98,8	3.89	54,9	2.16	26,7	1.05	1 3/4
1AA24MJ24	1SA24MJ24	1GA24MJ24	1BA24MJ24	1 7/8-12	-24	109,5	4.31	63,2	2.49	32,0	1.26	2
1AA32MJ32	1SA32MJ32	1GA32MJ32	—	2 1/2-12	-32	124,2	4.89	73,9	2.91	44,5	1.75	2 5/8

* Part number denotes 4S equivalent fitting.

Crimp fittings

Braided, low pressure and four spiral
(TTC / 1SA / IGA / TTC-12 Series)

H

Female SAE 45° swivel (FS)

1 Global TTC fittings

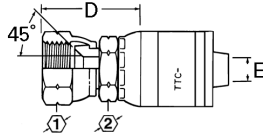

For use with hose:
2661(-12 thru -32), FC310, FC510, FC579, FC611, FC619 (-12 thru -32), FC639/FC839B, FC693, FC735, FC849/FC849B, GH120, GH194, GH195, GH663, GH681, GH781, GH793.

2 Global nipples

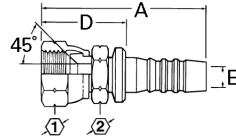

For use with hose:
Clamp: 2661 (-12 thru -20), FC619 (-12 thru -20).

Socket 1SA: 2681, FC310, FC510, FC639/FC839B (-4 thru -8), GH194 (-4 thru -20), GH663, GH681.

Socket 1SB: 2781, FC466, FC195, FC498, FC598, FC579, FC639/FC839B (-10 thru -16), FC735 (-4 thru -20), FC849/FC849B (-06 thru -12), GH120 (-4 thru -20), GH195, GH781 (-04 thru -20), GH793, 2766.

3 Global OTC fittings

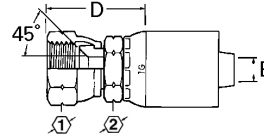

For use with hose:
2583, 2661, FC466, FC498, FC598, FC619, FC699.

4 Global TTC12 fittings

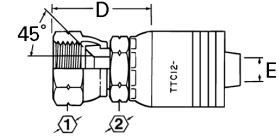

For use with hose:
FC636, FC736, GH493, EC525.

1 TTC part #	2 Nipple part #	3 OTC part #	4 TTC12 part #	Thd.	Hose size	A		D		EØ		1	2
						mm	in	mm	in	mm	in		
1AA4FS4	1SA4FS4	1GA4FS4	—	7/16-20	-04	50,8	2.00	27,2	1.07	4,3	0.17	9/16	9/16
1AA5FS4	1SA5FS4	1GA5FS4	—	1/2-20	-04	50,3	1.98	26,9	1.06	4,3	0.17	5/8	9/16
1AA4FS6	1SA4FS6	1GA4FS6	1BA4FS6 4SA4FS6*	7/16-20	-06	51,6	2.03	30,3	1.19	4,9	0.19	9/16	11/16
1AA6FS6	1SA6FS6	1GA6FS6	1BA6FS6 4SA6FS6*	5/8-18	-06	54,7	2.15	33,4	1.31	6,7	0.26	3/4	11/16
1AA8FS6	1SA8FS6	1GA8FS6	1BA8FS6	3/4-16	-06	58,7	2.31	33,3	1.31	6,6	0.26	7/8	11/16
1AA8FS8	1SA8FS8	1GA8FS8	1BA8FS8	3/4-16	-08	66,8	2.63	37,1	1.46	9,7	0.38	7/8	13/16
1AA10FS8	1SA10FS8	1GA10FS8	1BA10FS8 4SA10FS8*	7/8-14	-08	64,6	2.54	37,4	1.47	9,6	0.38	1	13/16
—	1SA10FS10	1GA10FS10	—	7/8-14	-10	70,4	2.77	40,9	1.61	12,7	0.50	1	15/16
1AA12FS10	1SA12FS10	—	1BA12FS10	1 1/16-14	-10	69,1	2.72	39,9	1.57	12,7	0.50	1 1/4	1 1/16
1AA12FS12	1SA12FS12	1GA12FS12	1BA12FS12	1 1/16-14	-12	72,1	2.84	41,9	1.65	15,5	0.61	1 1/4	1 1/8

* Part number denotes 4S equivalent fitting.

Male boss o-ring (MB)

1 Global TTC fittings

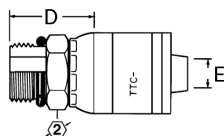

For use with hose:
2661(-12 thru -32), FC310, FC510, FC579, FC611, FC619 (-12 thru -32), FC639/FC839B, FC693, FC735, FC849/FC849B, GH120, GH194, GH195, GH663, GH681, GH781, GH793.

2 Global nipples

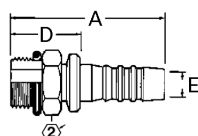

For use with hose:
Clamp: 2661 (-12 thru -20), FC619 (-12 thru -20).
Socket 1SA: 2681, FC310, FC510, FC639/FC839B (-4 thru -8), GH194 (-4 thru -20), GH663, GH681.
Socket 1SB: 2781, FC195, FC466, FC498, FC598, FC579, FC639/FC839B (-10 thru -16), FC735 (-4 thru -20), FC849/FC849B (-06 thru -12), GH120 (-4 thru -20), GH195, GH781 (-04 thru -20), GH793, 2766.

3 Global OTC fittings

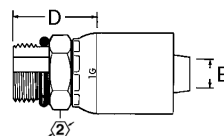

For use with hose:
2583, 2661, FC466, FC498, FC598, FC619, FC699.

4 Global TTC12 fittings

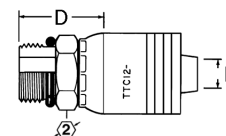

For use with hose:
FC636, FC736, GH493, EC525.

1 TTC part #	2 Nipple part #	3 OTC part #	4 TTC12 part #	Thd.	Hose size	A		D		EØ		① in
						mm	in	mm	in	mm	in	
1AA4MB4	1SA4MB4	1GA4MB4	—	7/16-20	-04	46,7	1.84	23,4	0.92	4,3	0.17	9/16
1AA5MB4	1SA5MB4	1GA5MB4	—	1/2-20	-04	46,7	1.84	23,4	0.92	4,3	0.17	5/8
1AA6MB4	1SA6MB4	1GA6MB4	—	9/16-18	-04	45,2	1.78	21,8	0.86	4,3	0.17	11/16
1AA6MB6	1SA6MB6	1GA6MB6	1BA6MB6 4SA6MB6*	9/16-18	-06	46,7	1.84	25,4	1.00	6,7	0.26	11/16
1AA8MB6	1SA8MB6	1GA8MB6	1BA8MB6 4SA8MB6*	3/4-16	-06	46,1	1.81	24,8	0.98	6,7	0.26	7/8
1AA10MB6	1SA10MB6	—	—	7/8-14	-06	47,8	1.88	26,7	1.05	6,6	0.26	1
1AA8MB8	1SA8MB8	1GA8MB8	1BA8MB8 4SA8MB8*	3/4-16	-08	57,4	2.26	30,1	1.19	9,6	0.38	7/8
1AA10MB8	1SA10MB8	1GA10MB8	1BA10MB8 4SA10MB8*	7/8-14	-08	54,8	2.16	27,6	1.09	9,6	0.38	1
1AA12MB8	1SA12MB8	1GA12MB8	1BA12MB8	1 1/16-12	-08	60,7	2.39	31,0	1.22	9,7	0.38	1 1/4
1AA8MB10	1SA8MB10	—	—	3/4-16	-10	56,1	2.21	30,2	1.19	12,7	0.50	15/16
1AA10MB10	1SA10MB10	1GA10MB10	1BA10MB10 4SA10MB10*	7/8-14	-10	59,5	2.34	33,4	1.31	12,8	0.50	1
1AA10MB12	1SA10MB12	—	—	7/8-14	-12	64,3	2.53	37,1	1.46	12,2	0.48	1 1/8
1AA12MB10	1SA12MB10	1GA12MB10	1BA12MB10 4SA12MB10*	1 1/16-12	-10	57,3	2.26	31,2	1.23	12,8	0.50	1 1/4
1AA12MB12	1SA12MB12	1GA12MB12	1BA12MB12	1 1/16-12	-12	62,0	2.44	31,8	1.25	15,5	0.61	1 1/4
1AA16MB12	1SA16MB12	1GA16MB12	1BA16MB12	1 5/16-12	-12	65,0	2.56	34,8	1.37	15,5	0.61	1 1/2
1AA16MB16	1SA16MB16	1GA16MB16	1BA16MB16	1 5/16-12	-16	69,6	2.74	35,3	1.39	20,8	0.82	1 1/2
1AA20MB20	1SA20MB20	1GA20MB20	1BA20MB20	1 5/8-12	-20	92,2	3.63	48,3	1.90	26,7	1.05	1 7/8
1AA24MB24	1SA24MB24	1GA24MB24	1BA24MB24	1 7/8-12	-24	92,2	3.63	46,0	1.81	32,0	1.26	2 1/8

† Nipples do not include O-ring. See pages H-87–H-92 for o-rings.

* Part number denotes 4S equivalent fitting.

Crimp fittings

Braided, low pressure and four spiral
(TTC / 1SA / 1GA / TTC-12 Series)

H

Female ORS swivel (FR)

1 Global TTC fittings

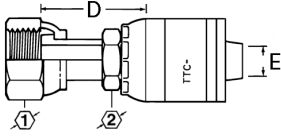

For use with hose:
2661(-12 thru -32), FC310, FC510, FC579, FC611, FC619 (-12 thru -32), FC639/FC839B, FC693, FC735, FC849/FC849B, GH120, GH194, GH195, GH663, GH681, GH781, GH793.

2 Global nipples

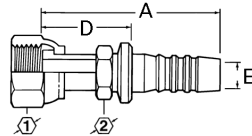

For use with hose:
Clamp: 2661 (-12 thru -20), FC619 (-12 thru -20).
Socket 1SA: 2681, FC310, FC510, FC639/FC839B (-4 thru -8), GH194 (-4 thru -20), GH663, GH681.
Socket 1SB: 2781, FC466, FC195, FC498, FC598, FC579, FC639/FC839B (-10 thru -16), FC735 (-4 thru -20), FC849/FC849B (-06 thru -12), GH120 (-4 thru -20), GH195, GH781 (-04 thru -20), GH793, 2766.

3 Global OTC fittings

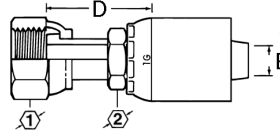

For use with hose:
2583, 2661, FC466, FC498, FC598, FC619, FC699.

4 Global TTC12 fittings

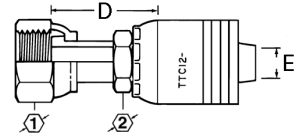

For use with hose:
FC636, FC736, GH493, EC525.

1 TTC part #	2 Nipple part #	3 OTC part #	4 TTC12 part #	Thd.	Hose size	A		D		EØ		1	2
						mm	in	mm	in	mm	in		
1AA4FR4	1SA4FR4	1GA4FR4	—	9/16-18	-04	49,5	1.95	26,1	1.03	4,2	0.17	11/16	9/16
1AA6FR4	1SA6FR4	1GA6FR4	—	11/16-16	-04	51,8	2.04	28,4	1.12	4,2	0.17	13/16	9/16
1AA8FR4	1SA8FR4	—	—	13/16-16	-04	52,3	2.06	32,5	1.28	4,1	0.16	13/16	15/16
1AA4FR6	1SA4FR6	1GA4FR6	1BA4FR6	9/16-18	-06	54,4	2.14	29,2	1.15	4,3	0.17	11/16	11/16
1AA6FR6	1SA6FR6	1GA6FR6	1BA6FR6 4SA6FR6*	11/16-16	-06	52,7	2.07	31,4	1.24	6,7	0.26	13/16	11/16
1AA8FR6	1SA8FR6	1GA8FR6	1BA8FR6 4SA8FR6*	13/16-16	-06	54,4	2.14	33,6	1.32	6,7	0.26	15/16	11/16
1AA6FR8	1SA6FR8	1GA6FR8	1BA6FR8 4SA6FR8*	11/16-16	-08	61,3	2.41	34,1	1.34	6,7	0.26	13/16	7/8
1AA8FR8	1SA8FR8	1GA8FR8	1BA8FR8 4SA8FR8*	13/16-16	-08	66,2	2.61	38,1	1.50	9,1	0.36	15/16	7/8
1AA10FR8	1SA10FR8	1GA10FR8	1BA10FR8 4SA10FR8*	1-14	-08	65,4	2.57	37,3	1.47	9,6	0.38	1 1/8	7/8
1AA12FR8	1SA12FR8	1GA12FR8	1BA12FR8	1 3/16-16	-08	71,1	2.80	41,4	1.63	9,7	0.38	1 3/8	1 1/8
1AA8FR10	1SA8FR10	1GA8FR10	1BA8FR10	13/16-16	-10	67,8	2.67	38,4	1.51	9,7	0.38	15/16	15/16
1AA10FR10	1SA10FR10	1GA10FR10	1BA10FR10 4SA10FR10	1-14	-10	66,5	2.62	40,8	1.61	11,5	0.45	1 1/8	1 1/16
1AA12FR10	1SA12FR10	1GA12FR10	1BA12FR10 4SA12FR10*	1 3/16-12	-10	67,2	2.65	41,4	1.63	12,8	0.50	1 3/8	1 1/16
1AA10FR12	1SA10FR12	1GA10FR12	1BA10FR12	1-14	-12	71,4	2.81	41,4	1.62	12,2	0.48	1 1/8	1 1/8
1AA12FR12	1SA12FR12	1GA12FR12	1BA12FR12	1 3/16-12	-12	73,9	2.91	43,7	1.72	15,5	0.61	1 3/8	1 1/8
1AA16FR12	1SA16FR12	1GA16FR12	1BA16FR12	1 7/16-12	-12	75,7	2.98	45,5	1.79	15,5	0.61	1 5/8	1 3/8
1AA12FR16	1SA12FR16	1GA12FR16	1BA12FR16	1 3/16-12	-16	81,8	3.22	47,2	1.86	15,5	0.61	1 3/8	1 3/8
1AA16FR16	1SA16FR16	1GA16FR16	1BA16FR16	1 7/16-12	-16	83,6	3.29	49,3	1.94	20,6	0.81	1 5/8	1 3/8
1AA20FR16	1SA20FR16	1GA20FR16	1BA20FR16	1 11/16-12	-16	82,6	3.25	48,3	1.90	20,6	0.81	1 7/8	1 5/8
1AA20FR20	1SA20FR20	1GA20FR20	1BA20FR20	1 11/16-12	-20	103,4	4.07	59,2	2.33	25,9	1.02	1 7/8	1 3/4
1AA24FR20	1SA24FR20	1GA24FR20	—	2-12	-20	98,6	3.88	54,6	2.15	26,7	1.05	2 1/4	1
—	—	—	1BA24FR20	2-12	-20	95,0	3.74	55,6	2.19	26,7	1.05	2 1/4	2
1AA24FR24	1SA24FR24	1GA24FR24	—	2-12	-24	102,1	4.02	55,6	2.19	32,0	1.26	2 1/4	2
—	—	—	1BA24FR24	2-12	-24	99,8	3.93	56,1	2.21	32,0	1.26	2 1/4	2

* Part number denotes 4S equivalent fitting

Female ORS swivel 45° elbow (FRA)

1 Global TTC fittings

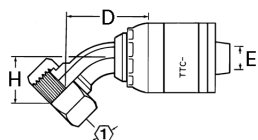

For use with hose:

2661 (-12 thru -32), FC310, FC510, FC579, FC611, FC619 (-12 thru -32), FC639/FC839B, FC693, FC735, FC849/FC849B, GH120, GH194, GH195, GH663, GH681, GH781, GH793.

2 Global nipples

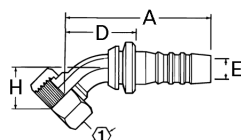

For use with hose:

Clamp: 2661 (-12 thru -20), FC619 (-12 thru -20).

Socket 1SA: 2681, FC310, FC510, FC639/FC839B (-4 thru -8), GH194 (-4 thru -20), GH663, GH681.

Socket 1SB: 2781, FC466, FC195, FC498, FC598, FC579, FC639/FC839B (-10 thru -16), FC735 (-4 thru -20), FC849/FC849B (-06 thru -12), GH120 (-4 thru -20), GH195, GH781 (-04 thru -20), GH793, 2766.

3 Global OTC fittings

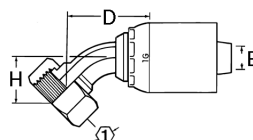

For use with hose:

2583, 2661, FC466, FC498, FC598, FC619, FC699.

4 Global TTC12 fittings

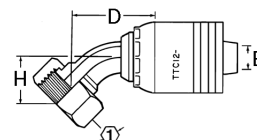

For use with hose:

FC636, FC736, GH493, EC525.

1 TTC part #	2 Nipple part #	3 OTC part #	4 TTC12 part #	Thd.	Hose size	A		D		EØ		H		① in
						mm	in	mm	in	mm	in	mm	in	
1AA4FRA4	1SA4FRA4	1GA4FRA4	—	9/16-18	-04	53,8	2.12	30,4	1.20	4,2	0.17	10,4	0.41	11/16
1AA6FRA4	1SA6FRA4	1GA6FRA4	—	11/16-16	-04	58,4	2.30	35,1	1.38	4,3	0.17	10,9	0.43	13/16
1AA4FRA6	1SA4FRA6	1GA4FRA6	1BA4FRA6 4SA4FRA6*	9/16-18	-06	54,4	2.14	33,1	1.30	4,2	0.17	10,4	0.41	11/16
1AA6FRA6	1SA6FRA6	1GA6FRA6	1BA6FRA6 4SA6FRA6*	11/16-16	-06	59,9	2.36	36,3	1.43	6,2	0.24	10,9	0.43	13/16
1AA8FRA6	1SA8FRA6	1GA8FRA6	1BA8FRA6 4SA8FRA6*	13/16-16	-06	65,6	2.58	44,3	1.74	6,7	0.26	15,0	0.59	15/16
1AA6FRA8	1SA6FRA8	—	—	11/16-16	-08	67,3	2.65	37,6	1.48	6,6	0.26	10,9	0.43	13/16
1AA8FRA8	1SA8FRA8	1GA8FRA8	1BA8FRA8 4SA8FRA8*	13/16-16	-08	76,1	3.00	45,5	1.79	8,5	0.33	15,0	0.59	15/16
1AA10FRA8	1SA10FRA8	1GA10FRA8	1BA10FRA8 4SA10FRA8*	1-14	-08	78,3	3.08	51,1	2.01	9,6	0.38	16,5	0.65	1 1/8
1AA12FRA8	1SA12FRA8	1GA12FRA8	—	1 3/16-12	-08	89,2	3.51	59,4	2.34	9,7	0.38	21,1	0.83	1 3/8
1AA10FRA10	1SA10FRA10	1GA10FRA10	1BA10FRA10 4SA10FRA10*	1-14	-10	80,9	3.18	51,3	2.02	11,0	0.44	16,5	0.65	1 1/8
1AA12FRA10	1SA12FRA10	—	1BA12FRA10 4SA12FRA10*	1 3/16-12	-10	86,1	3.39	60,0	2.36	12,8	0.50	21,1	0.83	1 3/8
1AA10FRA12	1SA10FRA12	—	—	1-14	-12	78,5	3.09	51,8	2.04	11,4	0.45	16,5	0.65	1 1/8
1AA12FRA12	1SA12FRA12	1GA12FRA12	1BA12FRA12	1 3/16-12	-12	90,7	3.57	60,5	2.38	14,0	0.55	21,1	0.83	1 3/8
1AA16FRA12	1SA16FRA12	1GA16FRA12	—	1 7/16-12	-12	102,6	4.04	72,4	2.85	15,5	0.61	23,9	0.94	1 5/8
1AA12FRA16	1SA12FRA16	—	—	1 3/16-12	-16	94,5	3.72	60,9	2.40	14,0	0.55	21,1	0.83	1 3/8
1AA16FRA16	1SA16FRA16	1GA16FRA16	1BA16FRA16	1 7/16-12	-16	107,4	4.23	73,1	2.88	20,6	0.81	23,9	0.94	1 5/8
1AA20FRA16	1SA20FRA16	—	—	1 11/16-12	-16	117,3	4.62	83,8	3.30	20,7	0.81	25,4	1.00	1 7/8
1AA20FRA20	1SA20FRA20	1GA20FRA20	1BA20FRA20	1 11/16-12	-20	129,5	5.10	85,6	3.37	25,9	1.02	25,4	1.00	1 7/8
1AA24FRA20	1SA24FRA20	1GA24FRA20	—	2-12	-20	139,4	5.49	95,5	3.76	25,7	1.01	27,2	1.07	2 1/4
1AA24FRA24	1SA24FRA24	1GA24FRA24	—	2-12	-24	115,3	4.54	68,8	2.71	32,0	1.26	27,2	1.07	2 1/4

* Part number denotes 4S equivalent fitting.

Crimp fittings

Braided, low pressure and four spiral
(TTC / 1SA / 1GA / TTC-12 Series)

H Female ORS swivel 90° short drop elbow (FRB)

1 Global TTC fittings

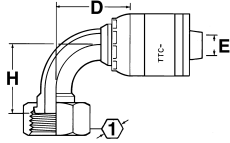

For use with hose:
2661(-12 thru -32), FC310, FC510, FC579, FC611, FC619 (-12 thru -32), FC639/FC839B, FC693, FC735, FC849/FC849B, GH120, GH194, GH195, GH663, GH681, GH781, GH793.

2 Global nipples

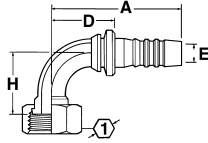

For use with hose:
Clamp: 2661 (-12 thru -20), FC619 (-12 thru -20).
Socket 1SA: 2681, FC310, FC510, FC639/FC839B (-4 thru -8), GH194 (-4 thru -20), GH663, GH681.
Socket 1SB: 2781, FC466, FC195, FC498, FC598, FC579, FC639/FC839B (-10 thru -16), FC735 (-4 thru -20), FC849/FC849B (-06 thru -12), GH120 (-4 thru -20), GH195, GH781 (-04 thru -20), GH793, 2766.

3 Global OTC fittings

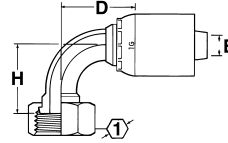

For use with hose:
2583, 2661, FC466, FC498, FC598, FC619, FC699.

4 Global TTC12 fittings

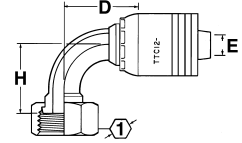

For use with hose:
FC636, FC736, GH493, EC525.

1 TTC part #	2 Nipple part #	3 OTC part #	4 TTC12 part #	Thd.	Hose size	A		D		EØ		H		1
						mm	in	mm	in	mm	in	mm	in	
1AA4FRB4	1SA4FRB4	1GA4FRB4	—	9/16-18	-04	53,1	2.09	23,3	0.92	4,2	0.17	20,8	0.82	11/16
1AA6FRB4	1SA6FRB4	1GA6FRB4	—	11/16-16	-04	56,4	2.22	25,1	0.99	4,2	0.17	22,9	0.90	13/16
—	1SA8FRB4	—	—	13/16-16	-04	60,2	2.37	36,8	1.45	4,3	0.17	30,2	1.19	15/16
1AA4FRB6	1SA4FRB6	1GA4FRB6	—	9/16-18	-06	56,1	2.21	30,7	1.21	4,3	0.17	20,8	0.82	11/16
1AA6FRB6	1SA6FRB6	1GA6FRB6	1BA6FRB6 4SA6FRB6*	11/16-16	-06	59,4	2.34	34,0	1.34	6,6	0.26	22,9	0.90	13/16
1AA8FRB6	1SA8FRB6	1GA8FRB6	1BA8FRB6 4SA8FRB6*	13/16-16	-06	66,5	2.62	41,4	1.62	6,6	0.26	29,2	1.15	15/16
1AA6FRB8	1SA6FRB8	1GA6FRB8	1BA6FRB8 4SA6FRB8*	11/16-16	-08	65,0	2.56	35,3	1.39	6,6	0.26	22,9	0.90	13/16
1AA8FRB8	1SA8FRB8	1GA8FRB8	1BA8FRB8 4SA8FRB8*	13/16-16	-08	72,1	2.84	42,4	1.67	9,1	0.36	29,2	1.15	15/16
1AA10FRB8	1SA10FRB8	1GA10FRB8	1BA10FRB8 4SA10FRB8*	1-14	-08	78,0	3.07	48,5	1.91	9,7	0.38	32,3	1.27	1 1/8
1AA12FRB8	1SA12FRB8	1GA12FRB8	1BA12FRB8 4SA12FRB8*	1 3/16-12	-08	87,6	3.45	57,9	2.28	9,7	0.38	47,8	1.88	1 3/8
1AA10FRB10	1SA10FRB10	1GA10FRB10	1BA10FRB10 4SA10FRB10*	1-14	-10	78,0	3.07	48,5	1.91	11,4	0.45	32,3	1.27	1 1/8
1AA12FRB10	1SA12FRB10	1GA12FRB10	1BA12FRB10 4SA12FRB10*	1 3/16-12	-10	87,4	3.44	58,2	2.29	12,7	0.50	47,8	1.88	1 3/8
1AA10FRB12	1SA10FRB12	1GA10FRB12	—	1-14	-12	79,0	3.11	49,0	1.93	11,4	0.45	32,3	1.27	1 1/8
1AA12FRB12	1SA12FRB12	1GA12FRB12	1BA12FRB12	1 3/16-12	-12	88,6	3.49	58,4	2.30	14,0	0.55	47,8	1.88	1 3/8
1AA16FRB12	1SA16FRB12	1GA16FRB12	1BA16FRB12	1 7/16-12	-12	102,6	4.04	72,4	2.85	15,5	0.61	56,1	2.21	1 5/8
1AA16FRB16	1SA16FRB16	1GA16FRB16	1BA16FRB16	1 7/16-12	-16	107,2	4.22	72,9	2.87	20,6	0.81	56,1	2.21	1 5/8
1AA20FRB16	1SA20FRB16	1GA20FRB16	—	1 11/16-12	-16	123,2	4.85	89,0	3.50	20,6	0.81	63,8	2.51	1 7/8
1AA20FRB20	1SA20FRB20	1GA20FRB20	1BA20FRB20	1 11/16-12	-20	134,6	5.30	90,7	3.57	25,9	1.02	63,8	2.51	1 7/8
1AA24FRB20	1SV24FRB20	—	—	2-12	-20	109,7	4.32	70,4	2.77	26,6	1.05	68,6	2.70	2 1/4
1AA24FRB24	1SA24FRB24	1GA24FRB24	—	2-12	-24	117,6	4.63	71,4	2.81	32,0	1.26	68,6	2.70	2 1/4

* Part number denotes 4S equivalent fitting.

Female ORS swivel 90° long drop elbow (FRC)

1 Global TTC fittings

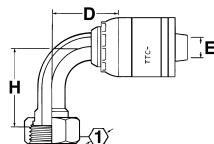

For use with hose:

2661(-12 thru -32), FC310, FC510, FC579, FC611, FC619 (-12 thru -32), FC639/FC839B, FC693, FC735, FC849/FC849B, GH120, GH194, GH195, GH663, GH681, GH781, GH793.

2 Global nipples

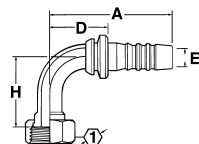

For use with hose:

Clamp: 2661 (-12 thru -20), FC619 (-12 thru -20).

Socket 1SA: 2681, FC310, FC510, FC639/FC839B (-4 thru -8), GH194 (-4 thru -20), GH663, GH681.

Socket 1SB: 2781, FC466, FC195, FC498, FC598, FC579, FC639/FC839B (-10 thru -16), FC735 (-4 thru -20), FC849/FC849B (-06 thru -12), GH120 (-4 thru -20), GH195, GH781 (-04 thru -20), GH793, 2766.

3 Global OTC fittings

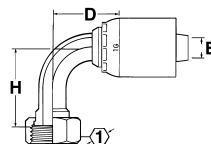

For use with hose:

2583, 2661, FC466, FC498, FC598, FC619, FC699.

4 Global TTC12 fittings

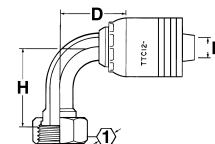

For use with hose:

FC636, FC736, GH493, EC525.

1 TTC part #	2 Nipple part #	3 OTC part #	4 TTC12 part #	Thd.	Hose size	A		D		EØ		H		① in
						mm	in	mm	in	mm	in	mm	in	
1AA4FRC4	1SA4FRC4	1GA4FRC4	—	9/16-18	-04	53,1	2.09	23,3	0.92	4,2	0.17	46,0	1.81	11/16
1AA6FRC4	1SA6FRC4	1GA6FRC4	—	11/16-16	-04	56,4	2.22	33,0	1.30	4,3	0.17	54,1	2.13	13/16
1AA8FRC4	1SA8FRC4	1GA8FRC4	—	13/16-16	-04	65,8	2.59	42,4	1.67	4,3	0.17	64,8	2.55	15/16
1AA6FRC6	1SA6FRC6	1GA6FRC6	1BA6FRC6 4SA6FRC6*	11/16-16	-06	57,6	2.27	34,1	1.34	6,2	0.24	54,1	2.13	13/16
1AA8FRC6	1SA8FRC6	1GA8FRC6	1BA8FRC6 4SA8FRC6*	13/16-16	-06	64,7	2.55	43,4	1.71	6,7	0.26	64,8	2.55	15/16
1AA8FRC8	1SA8FRC8	1GA8FRC8	1BA8FRC8 4SA8FRC8*	13/16-16	-08	73,0	2.87	42,4	1.67	8,5	0.33	63,8	2.51	15/16
1AA10FRC8	1SA10FRC8	1GA10FRC8	1BA10FRC8 4SA10FRC8*	1-14	-08	75,6	2.98	48,4	1.91	9,6	0.38	70,1	2.76	1 1/8
1AA10FRC10	1SA10FRC10	1GA10FRC10	1BA10FRC10 4SA10FRC10*	1-14	-10	78,3	3.08	48,6	1.91	11,0	0.44	70,1	2.76	1 1/8
1AA12FRC12**	1SA12FRC12	1GA12FRC12	1BA12FRC12	1 3/16-12	-12	88,4	3.48	58,4	2.30	14,2	0.56	96,0	3.78	1 3/8
1AA16FRC12	1SA16FRC12	—	—	1 7/16-12	-12	102,6	4.04	72,9	2.87	20,6	0.81	114,3	4.50	1 5/8
1AA16FRC16***	1SA16FRC16	1GA16FRC16	1BA16FRC16	1 7/16-12	-16	107,2	4.22	72,6	2.86	19,8	0.78	114,3	4.50	1 5/8
1AA20FRC20	1SA20FRC20	1GA20FRC20	1BA20FRC20	1 11/16-12	-20	134,6	5.30	90,7	3.57	25,7	1.01	129,3	5.09	1 7/8
1AA24FRC20	1SV24FRC20	—	—	2-12	-20	109,7	4.32	70,4	2.77	26,7	1.05	140,7	5.54	2 1/4
1AA24FRC24	1SA24FRC24	1GA24FRC24	—	2-12	-24	117,6	4.63	71,4	2.81	32,0	1.26	140,7	5.54	2 1/4

* Part number denotes 4S equivalent fitting.

** The 90° long drop tube elbow configuration meets a 3.5:1 burst, based on 4000psi operating pressure.

*** The 90° long drop tube elbow configuration meets a 3.7:1 burst, based on 3000psi operating pressure.

Crimp fittings

Braided, low pressure and four spiral
(TTC / 1SA / 1GA / TTC-12 Series)

H

Male ORS (MR)[†]

1 Global TTC fittings

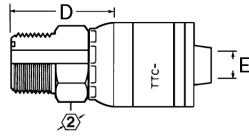

For use with hose:
2661(-12 thru -32), FC310, FC510, FC579, FC611, FC619 (-12 thru -32), FC639/FC839B, FC693, FC735, FC849/FC849B, GH120, GH194, GH195, GH663, GH681, GH781, GH793.

2 Global nipples

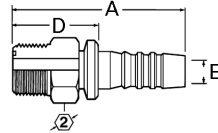

For use with hose:
Clamp: 2661 (-12 thru -20), FC619 (-12 thru -20).
Socket 1SA: 2681, FC310, FC510, FC639/FC839B (-4 thru -8), GH194 (-4 thru -20), GH663, GH681.
Socket 1SB: 2781, FC466, FC195, FC498, FC598, FC579, FC639/FC839B (-10 thru -16), FC735 (-4 thru -20), FC849/FC849B (-06 thru -12), GH120 (-4 thru -20), GH195, GH781 (-04 thru -20), GH793, 2766.

3 Global OTC fittings

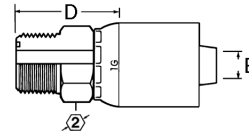

For use with hose:
2583, 2661, FC466, FC498, FC598, FC619, FC699.

4 Global TTC12 fittings

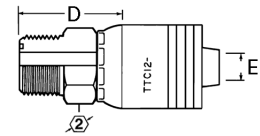

For use with hose:
FC636, FC736, GH493, EC525.

1 TTC part #	2 Nipple part #	3 OTC part #	4 TTC12 part #	Thd.	Hose size	A		D		EØ		in
						mm	in	mm	in	mm	in	
1AA4MR4	1SA4MR4	1GA4MR4	—	9/16-18	-04	45,2	1.78	21,8	0.86	4,3	0.17	5/8
1AA6MR6	1SA6MR6	1GA6MR6	1BA6MR6 4SA6MR6*	11/16-16	-06	52,1	2.05	29,3	1.16	6,7	0.26	3/4
1AA8MR6	1SA8MR6	1GA8MR6	1BA8MR6 4SA8MR6	13/16-16	-06	45,5	1.79	24,2	0.95	6,7	0.26	7/8
1AA8MR8	1SA8MR8	1GA8MR8	1BA8MR8 4SA8MR8*	13/16-16	-08	64,4	2.54	33,9	1.34	9,6	0.38	7/8
1AA10MR8	1SA10MR8	—	—	1-14	-08	55,1	2.17	29,7	1.17	9,7	0.38	1 1/16
1AA12MR8	1SA12MR8	—	—	1 3/16-12	-08	57,7	2.27	32,3	1.27	9,7	0.38	1 1/4
1AA10MR10	1SA10MR10	—	—	1-14	-10	57,4	2.26	36,6	1.44	12,2	0.48	1 1/16
1AA12MR10	1SA12MR10	—	—	1 3/16-12	-10	57,4	2.26	31,5	1.24	12,7	0.50	1 1/4
1AA12MR12	1SA12MR12	1GA12MR12	1BA12MR12	1 3/16-12	-12	66,8	2.63	38,9	1.53	15,5	0.61	1 1/4
1AA16MR12	1SA16MR12	1GA16MR12	1BA16MR12	1 7/16-12	-12	64,3	2.53	34,0	1.34	15,5	0.61	1 1/2
—	1SA16MR16	—	—	1 7/16-12	-16	76,2	3.00	41,7	1.64	20,6	0.81	1 1/2
1AA16MR16	1SA16MR16	—	—	1 7/16-12	-16	75,2	2.96	42,9	1.69	20,7	0.81	1 1/2
1AA20MR20	1SV20MR20	—	—	1 11/16-12	-20	85,1	3.35	45,7	1.80	26,2	1.03	1 3/4

[†] Does not include O-ring. See pages H-87–H-92 for o-rings.

* Part number denotes 4S equivalent fitting.

Male Staplok (SL)

1 Global TTC fittings

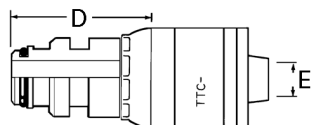

For use with hose:

2661(-12 thru -32), FC310, FC510, FC579, FC611, FC619 (-12 thru -32), FC639/FC839B, FC693, FC735, FC849/FC849B, GH120, GH194, GH195, GH663, GH681, GH781, GH793.

2 Global nipples

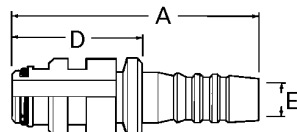

For use with hose:

Clamp: 2661 (-12 thru -20), FC619 (-12 thru -20).

Socket 1SA: 2681, FC310, FC510, FC639/FC839B (-4 thru -8), GH194 (-4 thru -20), GH663, GH681.

Socket 1SB: 2781, FC466, FC195, FC498, FC598, FC579, FC639/FC839B (-10 thru -16), FC735 (-4 thru -20), FC849/FC849B (-06 thru -12), GH120 (-4 thru -20), GH195, GH781 (-04 thru -20), GH793, 2766.

3 Global OTC fittings

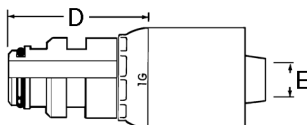

For use with hose:

2583, 2661, FC466, FC498, FC598, FC619, FC699.

4 Global TTC12 fittings

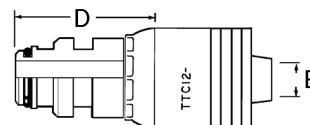

For use with hose:

FC636, FC736, GH493, EC525.

1 TTC part #	2 Nipple part #	3 OTC part #	4 TTC12 part #	Thd.	Hose size	A		D		EØ	
						mm	in	mm	in	mm	in
1A4SL4	1S4SL4	1G4SL4	—	—	-04	55,4	2.18	32,0	1.26	4,3	0.17
1A6SL6	1S6SL6	1G6SL6	1B6SL6 4S6SL6*	—	-06	58,4	2.30	33,0	1.30	6,6	0.26
1A8SL6	1S8SL6	1G8SL6	1B8SL6 4S8SL6*	—	-06	58,4	2.30	33,0	1.30	6,6	0.26
1A8SL8	1S8SL8	1G8SL8	1B8SL8	—	-08	64,0	2.52	34,3	1.35	9,7	0.38
1A12SL12	1S12SL12	1G12SL12	1B12SL12	—	-12	65,0	2.56	34,8	1.37	15,5	0.61
1A16SL16	1S16SL16	1G16SL16	1B16SL16	—	-16	74,9	2.95	40,6	1.60	20,6	0.81
1A20SL20	1S20SL20	1G20SL20	1B20SL20	—	-20	86,4	3.40	42,4	1.67	26,7	1.05
1A32SL32	1S32SL32	1G32SL32	—	—	-32	98,3	3.87	48,0	1.89	44,5	1.75

* Part number denotes 4S equivalent fitting

Crimp fittings

Braided, low pressure and four spiral
(TTC / 1SA / 1GA / TTC-12 Series)

H

Male SAE inverted flare swivel (MF)

1 Global TTC fittings

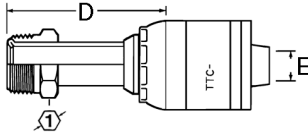

For use with hose:
2661(-12 thru -32), FC310, FC510, FC579, FC611, FC619 (-12 thru -32), FC639/FC839B, FC693, FC735, FC849/FC849B, GH120, GH194, GH195, GH663, GH681, GH781, GH793.

2 Global nipples

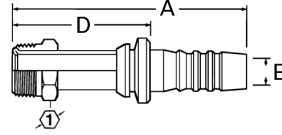

For use with hose:
Clamp: 2661 (-12 thru -20), FC619 (-12 thru -20).

Socket 1SA: 2681, FC310, FC510, FC639/FC839B (-4 thru -8), GH194 (-4 thru -20), GH663, GH681.

Socket 1SB: 2781, FC466, FC195, FC498, FC598, FC579, FC639/FC839B (-10 thru -16), FC735 (-4 thru -20), FC849/FC849B (-06 thru -12), GH120 (-4 thru -20), GH195, GH781 (-04 thru -20), GH793, 2766.

3 Global OTC fittings

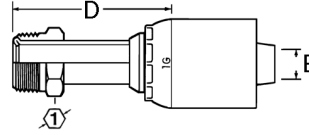

For use with hose:
2583, 2661, FC466, FC498, FC598, FC619, FC699.

4 Global TTC12 fittings

No offering

1 TTC part #	2 Nipple part #	3 OTC part #	4 TTC12 part #	Thd.	Hose size	A		D		EØ		① in
						mm	in	mm	in	mm	in	
—	1SA4MF3	—	—	7/16-24	-03	54,6	2.15	37,1	1.46	2,5	0.10	7/16
1AA3MF4	1SA3MF4	—	—	3/8-24	-04	61,5	2.42	38,1	1.50	2,5	0.10	3/8
1AA4MF4	1SA4MF4	1GA4MF4	—	7/16-24	-04	60,7	2.39	37,1	1.46	4,3	0.17	7/16
1AA5MF4	1SA5MF4	—	—	1/2-20	-04	60,7	2.39	37,1	1.46	4,3	0.17	1/2
1AA5MF6	1SA5MF6	1GA5MF6	—	1/2-20	-06	66,0	2.60	40,9	1.61	6,1	0.24	1/2
1AA4MF6	1SA4MF6	—	—	7/16-24	-06	64,3	2.53	38,9	1.53	4,3	0.17	7/16
1AA6MF6	1SA6MF6	1GA6MF6	—	5/8-18	-06	66,0	2.60	40,9	1.61	6,6	0.26	5/8
1AA7MF6	1SA7MF6	—	—	11/16-18	-06	62,2	2.45	40,6	1.60	6,6	0.26	11/16
1AA8MF8	1SA8MF8	1GA8MF8	—	3/4-18	-08	70,9	2.79	41,4	1.62	9,7	0.38	3/4
1AA10MF8	1SA10MF8	—	—	7/8-18	-08	74,7	2.94	49,0	1.93	9,7	0.38	7/8

Male SAE inverted flare swivel 45° elbow (MFA)

1 Global TTC fittings

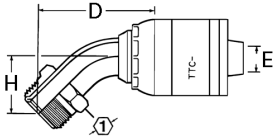

For use with hose:

2661 (-12 thru -32), FC310, FC510, FC579, FC611, FC619 (-12 thru -32), FC639/FC839B, FC693, FC735, FC849/FC849B, GH120, GH194, GH195, GH663, GH681, GH781, GH793.

2 Global nipples

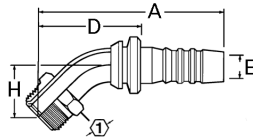

For use with hose:

Clamp: 2661 (-12 thru -20), FC619 (-12 thru -20).

Socket 1SA: 2681, FC310, FC510, FC639/FC839B (-4 thru -8), GH194 (-4 thru -20), GH663, GH681.

Socket 1SB: 2781, FC195, FC466, FC498, FC598, FC579, FC639/FC839B (-10 thru -16), FC735 (-4 thru -20), FC849/FC849B (-06 thru -12), GH120 (-4 thru -20), GH195, GH781 (-04 thru -20), GH793, 2766.

3 Global OTC fittings

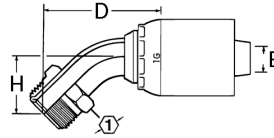

For use with hose:

2583, 2661, FC466, FC498, FC598, FC619, FC699.

4 Global TTC12 fittings

No offering

1 TTC part #	2 Nipple part #	3 OTC part #	4 TTC12 part #	Thd.	Hose size	A		D		EØ		H		① in
						mm	in	mm	in	mm	in	mm	in	
1AA3MFA4	1SA3MFA4			3/8-24	-04	69,9	2.75	49,8	1.96	2,5	0.10	17,5	0.69	3/8
1AA4MFA4	1SA4MFA4	1GA4MFA4	—	7/16-24	-04	67,8	2.67	44,5	1.75	4,3	0.17	24,4	0.96	7/16
1AA5MFA4	1SA5MFA4			1/2-20	-04	64,5	2.54	44,5	1.75	4,3	0.17	24,4	0.96	1/2
1AA4MFA6	1SA4MFA6	—	—	7/16-24	-06	71,4	2.81	46,0	1.81	4,3	0.17	24,4	0.96	7/16
1AA5MFA6	1SA5MFA6	1GA5MFA6	—	1/2-20	-06	73,2	2.88	48,0	1.89	6,1	0.24	24,4	0.96	1/2
1AA6MFA6	1SA6MFA6	1GA6MFA6	—	5/8-18	-06	73,2	2.88	48,0	1.89	6,6	0.26	24,4	0.96	5/8
1AA7MFA6	1SA7MFA6			11/16-18	-06	69,3	2.73	48,0	1.89	6,6	0.26	24,4	0.96	11/16
1AA8MFA8	1SA8MFA8	1GA8MFA8	—	3/4-18	-08	78,0	3.07	48,3	1.90	9,7	0.38	23,6	0.93	3/4

Male SAE inverted flare swivel 90° elbow (MFB)

1 Global TTC fittings

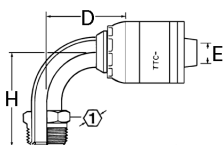

2 Global nipples

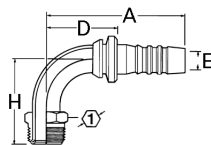

3 Global OTC fittings

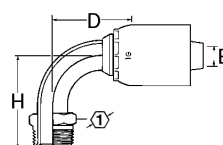

4 Global TTC12 fittings

No offering

1 TTC part #	2 Nipple part #	3 OTC part #	4 TTC12 part #	Thd.	Hose size	A		D		EØ		H		① in
						mm	in	mm	in	mm	in	mm	in	
1AA4MFB4	1SA4MFB4	1GA4MFB4	—	7/16-24	-04	58,2	2.29	34,8	1.37	4,3	0.17	42,3	1.69	7/16
1AA5MFB4	1SA5MFB4	—	—	1/2-20	-04	58,2	2.29	34,8	1.37	4,3	0.17	43,9	1.73	1/2
1AA4MFB6	1SA4MFB6	—	—	7/16-24	-06	61,7	2.43	36,6	1.44	4,3	0.17	42,3	1.69	7/16
1AA5MFB6	1SA5MFB6	1GA5MFB6	—	1/2-20	-06	63,8	2.51	38,4	1.51	6,1	0.24	43,9	1.73	1/2
1AA6MFB6	1SA6MFB6	1GA6MFB6	—	5/8-18	-06	63,8	2.51	38,4	1.51	6,6	0.26	43,9	1.73	5/8
1AA7MFB6	1SA7MFB6			11/16-18	-06	62,0	2.44	40,9	1.61	6,6	0.26	43,9	1.73	11/16
1AA8MFB8	1SA8MFB8	1GA8MFB8	—	3/4-18	-08	69,3	2.73	39,6	1.56	9,7	0.38	44,5	1.75	3/4

Crimp fittings

Braided, low pressure and four spiral
(TTC / 1SA / 1GA / TTC-12 Series)

H

JIS/BSPP female swivel (BF)[†]

1 Global TTC fittings

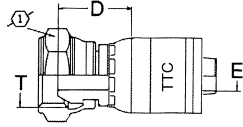

For use with hose:
2661(-12 thru -32), FC310, FC510, FC579, FC611, FC619 (-12 thru -32), FC639/FC839B, FC693, FC735, FC849/FC849B, GH120, GH194, GH195, GH663, GH681, GH781, GH793.

2 Global nipples

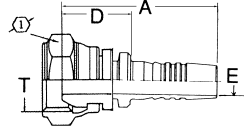

For use with hose:
Clamp: 2661 (-12 thru -20), FC619 (-12 thru -20).
Socket 1SA: 2681, FC310, FC510, FC639/FC839B (-4 thru -8), GH194 (-4 thru -20), GH663, GH681.
Socket 1SB: 2781, FC195, FC466, FC498, FC598, FC579, FC639/FC839B (-10 thru -16), FC735 (-4 thru -20), FC849/FC849B (-06 thru -12), GH120 (-4 thru -20), GH195, GH781 (-04 thru -20), GH793, 2766.

3 Global OTC fittings

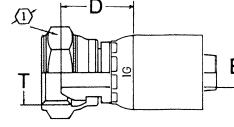

For use with hose:
2583, 2661, FC466, FC498, FC598, FC619, FC699.

4 Global TTC12 fittings

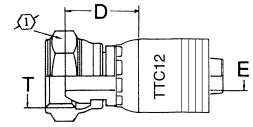

For use with hose:
FC636, FC736, GH493, EC525.

1 TTC part #	2 Nipple part #	3 OTC part #	4 TTC12 part #	Thd. T	Hose size	A		D		EØ		①	
						mm	in	mm	in	mm	in	mm	in
1A4BF4	1S4BF4	1G4BF4	—	G 1/4	-04	42,3	1.66	18,9	0.74	4,2	0.16	19,0	0.75
1A6BF4	1S6BF4	—	—	G 3/8*	-04	45,5	1.79	22,1	0.87	4,3	0.17	22,0	0.87
1A6BF6	1S6BF6	1G6BF6	1B6BF6 4S6BF6*	G 3/8	-06	46,4	1.83	21,1	0.83	6,7	0.26	22,0	0.87
1A8BF6	1S8BF6	1G8BF6	—	G 1/2	-06	47,9	1.88	22,6	0.89	6,7	0.26	27,0	1.06
1A8BF8	1S8BF8	1G8BF8	1B8BF8 4S8BF8*	G 1/2	-08	53,5	2.11	23,8	0.94	9,6	0.38	27,0	1.06
1A10BF8	1S10BF8	—	—	G 5/8*	-08	56,4	2.22	26,7	1.05	9,6	0.38	30,0	1.18
1A10BF10	1S10BF10	1G10BF10	—	G 5/8	-10	54,1	2.13	24,7	0.97	12,8	0.50	30,0	1.18
1A12BF12	1S12BF12	1G12BF12	1B12BF12	G 3/4	-12	55,5	2.18	25,3	1.00	15,5	0.61	32,0	1.26
1A16BF16	1S16BF16	1G16BF16	1B16BF16	G 1	-16	62,0	2.44	27,6	1.09	20,7	0.81	41,0	1.61
1A20BF20	1S20BF20	1G20BF20	1B20BF20	G 1 1/4	-20	73,6	2.90	29,6	1.16	26,6	1.05	50,0	1.97
—	1S24BF24	1G24BF24	1B24BF24	G 1 1/2	-24	80,0	3.15	33,7	1.33	32,0	1.26	55,0	2.16
—	1S32BF32	1G32BF32	—	G 2	-32	85,4	3.36	35,2	1.38	44,4	1.75	70,0	2.75

* Part number denotes 4S equivalent fitting

† The JIS parallel thread and the BSPP connection are interchangeable. G as part of thread size is ISO Designation for parallel thread.

JIS/BSPP female swivel (JM)[†]

1 Global TTC fittings

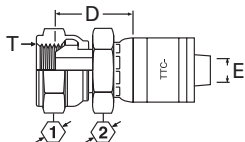

For use with hose:

2661(-12 thru -32), FC310, FC510, FC579, FC611, FC619 (-12 thru -32), FC639/FC839B, FC693, FC735, FC849/FC849B, GH120, GH194, GH195, GH663, GH681, GH781, GH793.

2 Global nipples

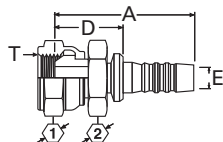

For use with hose:

Clamp: 2661 (-12 thru -20), FC619 (-12 thru -20).

Socket 1SA: 2681, FC310, FC510, FC639/FC839B (-4 thru -8), GH194 (-4 thru -20), GH663, GH681.

Socket 1SB: 2781, FC466, FC195, FC498, FC598, FC579, FC639/FC839B (-10 thru -16), FC735 (-4 thru -20), FC849/FC849B (-06 thru -12), GH120 (-4 thru -20), GH195, GH781 (-04 thru -20), GH793, 2766.

3 Global OTC fittings

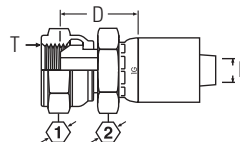

For use with hose:

2583, 2661, FC466, FC498, FC598, FC619, FC699.

4 Global TTC12 fittings

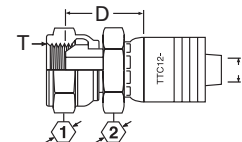

For use with hose:

FC636, FC736, GH493, EC525.

1 TTC part #	2 Nipple part #	3 OTC part #	4 TTC12 part #	Thd.	Hose size	A		D		EØ		1		2	
						mm	in	mm	in	mm	in	mm	in	mm	in
1A4JM4	1S4JM4	1G4JM4	—	G 1/4	-04	47,0	1.85	23,6	0.93	4,2	0.16	19,0	0.75	19,0	0.75
1A6JM6	1S6JM6	1G6JM6	—	G 3/8	-06	51,0	2.01	25,7	1.01	6,7	0.26	22,0	0.87	22,0	0.87
1A8JM8	1S8JM8	1G8JM8	1B8JM8	G 1/2	-08	58,0	2.28	28,3	1.11	9,6	0.38	27,0	1.06	27,0	1.06
1A12JM12	1S12JM12	1G12JM12	1B12JM12	G 3/4	-12	62,0	2.44	31,8	1.25	15,5	0.61	32,0	1.26	36,0	1.42
1A16JM16	1S16JM16	1G16JM16	1B16JM16	G 1	-16	69,0	2.72	34,6	1.36	20,7	0.81	41,0	1.61	41,0	1.61
1A20JM20	1S20JM20	1G20JM20	1B20JM20	G 1 1/4	-20	80,2	3.16	36,2	1.42	26,6	1.05	50,0	1.97	46,0	1.81

[†]The JIS parallel thread and the BSPP connection are interchangeable. G as part of thread size is ISO Designation for parallel thread.

Crimp fittings

Braided, low pressure and four spiral
(TTC / 1SA / 1GA / TTC-12 Series)

H

JIS/BSPP female swivel, 45° elbow (BFA)†

1 Global TTC fittings

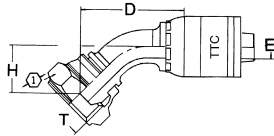

For use with hose:
2661(-12 thru -32), FC310, FC510, FC579, FC611, FC619 (-12 thru -32), FC639/FC839B, FC693, FC735, FC849/FC849B, GH120, GH194, GH195, GH663, GH681, GH781, GH793.

2 Global nipples

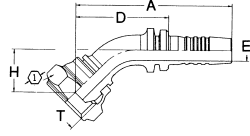

For use with hose:
Clamp: 2661 (-12 thru -20), FC619 (-12 thru -20).
Socket 1SA: 2681, FC310, FC510, FC639/FC839B (-4 thru -8), GH194 (-4 thru -20), GH663, GH681.
Socket 1SB: 2781, FC466, FC195, FC498, FC598, FC579, FC639/FC839B (-10 thru -16), FC735 (-4 thru -20), FC849/FC849B (-06 thru -12), GH120 (-4 thru -20), GH195, GH781 (-04 thru -20), GH793, 2766.

3 Global OTC fittings

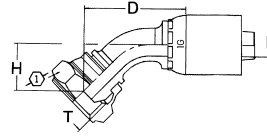

For use with hose:
2583, 2661, FC466, FC498, FC598, FC619, FC699.

4 Global TTC12 fittings

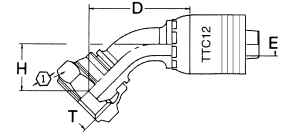

For use with hose:
FC636, FC736, GH493, EC525.

1 TTC part #	2 Nipple part #	3 OTC part #	4 TTC12 part #	Thd.	Hose size	A		D		EØ		H		1	
						mm	in	mm	in	mm	in	mm	in	mm	in
1A4BFA4	1S4BFA4	1G4BFA4	—	G 1/4	-04	65,3	2.57	41,9	1.65	4,2	0.16	16,5	0.65	19,0	0.75
1A6BFA6	1S6BFA6	1G6BFA6	—	G 3/8	-06	73,8	2.90	48,5	1.91	6,7	0.26	19,0	0.75	22,0	0.87
1A8BFA8	1S8BFA8	1G8BFA8	1B8BFA8 4S8BFA8*	G 1/2	-08	91,5	3.60	61,8	2.43	9,6	0.38	24,8	0.98	27,0	1.06
1A10BFA10	1S10BFA10	1G10BFA10	—	G 5/8	-10	100,4	3.95	71,0	2.79	12,8	0.50	27,4	1.08	30,0	1.18
1A12BFA12	1S12BFA12	1G12BFA12	1B12BFA12	G 3/4	-12	108,8	4.28	78,6	3.09	15,5	0.61	29,4	1.16	32,0	1.26
1A16BFA16	1S16BFA16	1G16BFA16	1B16BFA16	G 1	-16	126,8	4.99	92,4	3.09	20,7	0.81	33,2	1.31	41,0	1.61
1A20BFA20	1S20BFA20	1G20BFA20	1B20BFA20	G 1 1/4	-20	153,6	6.05	109,6	4.31	26,6	1.05	37,2	1.46	50,0	1.97

†The JIS parallel thread and the BSPP connection are interchangeable. G as part of thread size is ISO Designation for parallel thread.
* Part number denotes 4S equivalent fitting.

JIS/BSPP female swivel 90° elbow (BFB)†

1 Global TTC fittings

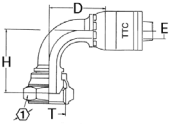

For use with hose:
2661(-12 thru -32), FC310, FC510, FC579, FC611, FC619 (-12 thru -32), FC639/FC839B, FC693, FC735, FC849/FC849B, GH120, GH194, GH195, GH663, GH681, GH781, GH793.

2 Global nipples

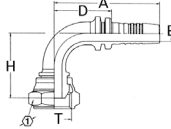

For use with hose:
Clamp: 2661 (-12 thru -20), FC619 (-12 thru -20).
Socket 1SA: 2681, FC310, FC510, FC639/FC839B (-4 thru -8), GH194 (-4 thru -20), GH663, GH681.
Socket 1SB: 2781, FC466, FC195, FC498, FC598, FC579, FC639/FC839B (-10 thru -16), FC735 (-4 thru -20), FC849/FC849B (-06 thru -12), GH120 (-4 thru -20), GH195, GH781 (-04 thru -20), GH793, 2766.

3 Global OTC fittings

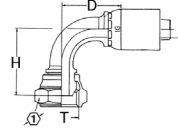

For use with hose:
2583, 2661, FC466, FC498, FC598, FC619, FC699.

4 Global TTC12 fittings

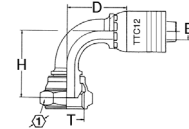

For use with hose:
FC636, FC736, GH493, EC525.

1 TTC part #	2 Nipple part #	3 OTC part #	4 TTC12 part #	Thd.	Hose size	A		D		EØ		H		1	
						mm	in	mm	in	mm	in	mm	in	mm	in
1A4BFB4	1S4BFB4	1G4BFB4	—	G 1/4	-04	45,8	1.80	22,4	0.88	4,2	0.16	24,8	0.98	17,0	0.67
1A6BFB6	1S6BFB6	1G6BFB6	—	G 3/8	-06	58,9	2.32	33,6	1.32	6,7	0.26	35,0	1.38	22,0	0.87
1A8BFB6	1S8BFB6	1G8BFB6	—	G 1/2	-06	75,7	2.98	50,4	1.98	6,7	0.26	47,8	1.88	27,0	1.06
1A8BFB8	1S8BFB8	1G8BFB8	1B8BFB8 4S8BFB8*	G 1/2	-08	63,9	2.52	34,2	1.35	9,6	0.38	37,5	1.48	27,0	1.06
1A10BFB8	1S10BFB8	—	—	G 5/8*	-08	90,7	3.57	61,0	2.40	9,6	0.38	56,3	2.22	27,0	1.06
1A10BFB10	1S10BFB10	1G10BFB10	—	G 5/8	-10	90,6	3.57	61,2	1.41	12,8	0.50	56,3	2.22	27,0	1.06
1A12BFB12	1S12BFB12	1G12BFB12	1B12BFB12	G 3/4	-12	82,2	3.24	52,0	2.05	15,5	0.61	47,5	1.87	32,0	1.26
1A16BFB16	1S16BFB16	1G16BFB16	1B16BFB16	G 1	-16	118,2	4.65	83,8	3.30	20,7	0.81	71,5	2.81	41,0	1.61
1A20BFB20	1S20BFB20	1G20BFB20	1B20BFB20	G 1 1/4	-20	146,2	5.75	102,2	4.02	26,6	1.05	82,5	3.25	50,0	1.97

†The JIS parallel thread and the BSPP connection are interchangeable. G as part of thread size is ISO Designation for parallel thread.

* Part number denotes 4S equivalent fitting.

Crimp fittings

Braided, low pressure and four spiral
(TTC / 1SA / 1GA / TTC-12 Series)

H

BSP male tapered, BSPT (BT) †

1 Global TTC fittings

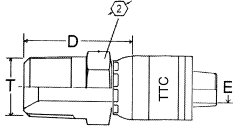

For use with hose:
2661(-12 thru -32), FC310, FC510, FC579, FC611, FC619 (-12 thru -32), FC639/FC839B, FC693, FC735, FC849/FC849B, GH120, GH194, GH195, GH663, GH681, GH781, GH793.

2 Global nipples

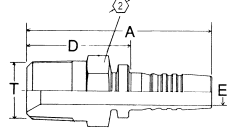

For use with hose:
Clamp: 2661 (-12 thru -20), FC619 (-12 thru -20).
Socket 1SA: 2681, FC310, FC510, FC639/FC839B (-4 thru -8), GH194 (-4 thru -20), GH663, GH681.
Socket 1SB: 2781, FC466, FC195, FC498, FC598, FC579, FC639/FC839B (-10 thru -16), FC735 (-4 thru -20), FC849/FC849B (-06 thru -12), GH120 (-4 thru -20), GH195, GH781 (-04 thru -20), GH793, 2766.

3 Global OTC fittings

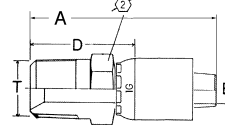

For use with hose:
2583, 2661, FC466, FC498, FC598, FC619, FC699.

4 Global TTC12 fitting

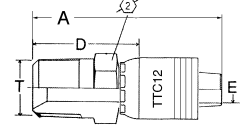

For use with hose:
FC636, FC736, GH493, EC525.

1 TTC part #	2 Nipple part #	3 OTC part #	4 TTC12 part #	Thd.	Hose size	A		D		EØ		2	
						mm	in	mm	in	mm	in	mm	in
1A4BT4	1S4BT4	1G4BT4	—	R 1/4 -19	-04	50,6	1.99	27,2	1.07	4,2	0.16	14,0	0.55
1A6BT6	1S6BT6	1G6BT6	1B6BT6	R 3/8-19	-06	54,9	2.16	29,6	1.16	6,7	0.26	19,0	0.75
1A8BT8	1S8BT8	1G8BT8	1B8BT8	R 1/2 -14	-08	66,2	2.61	36,5	1.44	9,6	0.38	22,0	0.87
1A12BT12	1S12BT12	1G12BT12	1B12BT12	R 3/4 -14	-12	71,1	2.80	40,9	1.61	15,5	0.61	30,0	1.18
1A16BT16	1S16BT16	1G16BT16	1B16BT16	R 1 -11	-16	81,2	3.20	46,8	1.84	20,7	0.81	36,0	1.42
1A20BT20	1S20BT20	1G20BT20	1B20BT20	R 1 1/4 -11	-20	96,2	3.79	52,2	2.05	26,6	1.05	46,0	1.81
—	—	—	1B24BT24	R 1 1/4 -11	-24	100,8	3.97	54,5	2.14	32,0	1.26	50,0	1.97

†The JIS parallel thread and the BSPP connection are interchangeable.

BSP male parallel, BSPP (BP)

1 Global TTC fittings

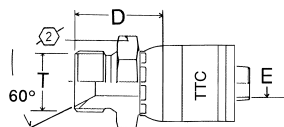

For use with hose:

2661(-12 thru -32), FC310, FC510, FC579, FC611, FC619 (-12 thru -32), FC639/FC839B, FC693, FC735, FC849/FC849B, GH120, GH194, GH195, GH663, GH681, GH781, GH793.

2 Global nipples

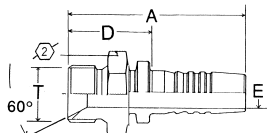

For use with hose:

Clamp: 2661 (-12 thru -20), FC619 (-12 thru -20).

Socket 1SA: 2681, FC310, FC510, FC639/FC839B (-4 thru -8), GH194 (-4 thru -20), GH663, GH681.

Socket 1SB: 2781, FC466, FC195, FC498, FC598, FC579, FC639/FC839B (-10 thru -16), FC735 (-4 thru -20), FC849/FC849B (-06 thru -12), GH120 (-4 thru -20), GH195, GH781 (-04 thru -20), GH793, 2766.

3 Global OTC fittings

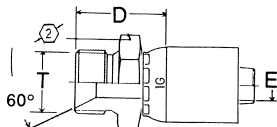

For use with hose:

2583, 2661, FC466, FC498, FC598, FC619, FC699.

4 Global TTC12 fittings

No offering

1 TTC part #	2 Nipple part #	3 OTC part #	4 TTC12 part #	Thd.	Hose size	A		D		EØ		⊘	
						mm	in	mm	in	mm	in	mm	in
1A4BP4	1S4BP4	1G4BP4	—	G 1/4 -19	-04	44,3	1.74	20,9	0.82	4,2	0.16	19,0	0.75
1A6BP6	1S6BP6	1G6BP6	—	G 3/8 -19	-06	48,4	1.90	23,1	0.91	6,7	0.26	22,0	0.87
1A6BP8	1S6BP8			G 3/8 -19	-08	55,9	2.20	26,4	1.04	9,6	0.38	22,0	0.87
1A8BP6	1S8BP6	1G8BP6	—	G 1/2 -14	-06	52,4	2.06	27,1	1.07	6,7	0.26	27,0	1.06
1A8BP8	1S8BP8	1G8BP8	—	G 1/2 -14	-08	58,0	2.28	28,3	1.11	9,6	0.38	27,0	1.06
1A10BP10	1S10BP10			G 5/8 -14	-10	62,0	2.44	35,5	1.25	12,7	0.50	30,0	1.18
1A12BP12	1S12BP12	1G12BP12	—	G 3/4 -14	-12	63,1	2.48	32,9	1.29	15,5	0.61	32,0	1.26
1A16BP16	1S16BP16	1G16BP16	—	G1 -11	-16	70,9	2.79	36,5	1.44	20,7	0.81	41,0	1.61
1A20BP20	1S20BP20	—	—	G 1 1/4 -11	-20	86,1	3.39	42,2	1.66	26,6	1.50	50,0	1.97

G as part of thread size is ISO Designation for parallel thread.

Crimp fittings

Braided, low pressure and four spiral
(TTC / 1SA / 1GA / TTC-12 Series)

H

DKO female swivel, light duty (DL)

1 Global TTC fittings

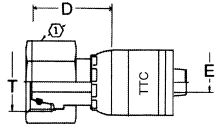

For use with hose:
2661(-12 thru -32), FC310, FC510, FC579, FC611, FC619 (-12 thru -32), FC639/FC839B, FC693, FC735, FC849/FC849B, GH120, GH194, GH195, GH663, GH681, GH781, GH793.

2 Global nipples

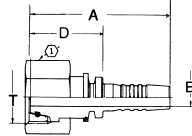

For use with hose:
Clamp: 2661 (-12 thru -20), FC619 (-12 thru -20).
Socket 1SA: 2681, FC310, FC510, FC639/FC839B (-4 thru -8), GH194 (-4 thru -20), GH663, GH681.
Socket 1SB: 2781, FC466, FC195, FC498, FC598, FC579, FC639/FC839B (-10 thru -16), FC735 (-4 thru -20), FC849/FC849B (-06 thru -12), GH120 (-4 thru -20), GH195, GH781 (-04 thru -20), GH793, 2766.

3 Global OTC fittings

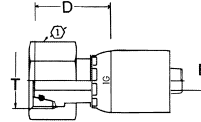

For use with hose:
2583, 2661, FC466, FC498, FC598, FC619, FC699.

4 Global TTC12 fittings

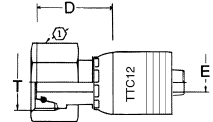

For use with hose:
FC636, FC736, GH493, EC525.

1 TTC part #	2 Nipple part #	3 OTC part #	4 TTC12 part #	Thd. T	Tube O.D.	Hose size	A		D		EØ		①	
							mm	in	mm	in	mm	in	mm	in
1A5DL4	1S5DL4	1G5DL4	—	M12 x 1.5	6	-04	48,0	1.89	24,6	0.97	4,2	0.16	17,0	0.67
1A6DL4	S6DL4	1G6DL4	—	M14 x 1.5	8	-04	46,0	1.81	22,6	0.89	4,2	0.16	17,0	0.67
1A8DL4	1S8DL4	—	—	M16 x 1.5	10	-04	48,3	1.90	24,9	0.98	4,3	0.17	19,0	0.75
1A8DL6	1S8DL6	1G8DL6	1B8DL6 4S8DL6*	M16 x 1.5	10	-06	50,5	1.99	25,2	0.99	6,7	0.26	19,0	0.75
1A10DL6	1S10DL6	1G10DL6	1B10DL6 4S10DL6*	M18 x 1.5	12	-06	51,2	2.01	25,9	1.02	6,7	0.26	22,0	0.87
1A12DL8	1S12DL8	1G12DL8	1B12DL8 4S12DL8*	M22 x 1.5	15	-08	58,3	2.30	28,6	1.13	9,6	0.38	27,0	1.06
1A16DL10	1S16DL10	1G16DL10	1B16DL10 4S16DL10*	M26 x 1.5	18	-10	59,2	2.33	29,8	1.17	12,8	0.50	32,0	1.26
1A20DL12	1S20DL12	1G20DL12	1B20DL12	M30 x 2	22	-12	62,5	2.46	32,3	1.27	15,5	0.61	36,0	1.42
1A25DL16	1S25DL16	1G25DL16	1B25DL16	M36 x 2	28	-16	68,2	2.68	33,8	1.33	20,7	0.81	41,0	1.61
1A32DL20	1S32DL20	1G32DL20	1B32DL20	M45 x 2	35	-20	83,7	3.29	39,7	1.56	26,6	1.05	50,0	1.97
1A40DL24	1S40DL24	1G40DL24	—	M52 x 2	42	-24	87,2	3.43	40,9	1.61	32,0	1.26	60,0	2.36

* Part number denotes 4S equivalent fitting

DKO female swivel, light duty, 45° elbow (DLA)

1 Global TTC fittings

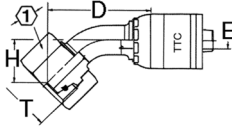

For use with hose:
2661(-12 thru -32), FC310, FC510, FC579, FC611, FC619 (-12 thru -32), FC639/FC839B, FC693, FC735, FC849/FC849B, GH120, GH194, GH195, GH663, GH681, GH781, GH793.

2 Global nipples



For use with hose:
Clamp: 2661 (-12 thru -20), FC619 (-12 thru -20).
Socket 1SA: 2681, FC310, FC510, FC639/FC839B (-4 thru -8), GH194 (-4 thru -20), GH663, GH681.
Socket 1SB: 2781, FC466, FC195, FC498, FC598, FC579, FC639/FC839B (-10 thru -16), FC735 (-4 thru -20), FC849/FC849B (-06 thru -12), GH120 (-4 thru -20), GH195, GH781 (-04 thru -20), GH793, 2766.

3 Global OTC fittings

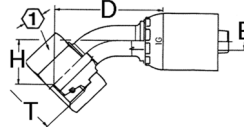

For use with hose:
2583, 2661, FC466, FC498, FC598, FC619, FC699.

4 Global TTC12 fittings

No offering

1 TTC part #	2 Nipple part #	3 OTC part #	4 TTC12 part #	Thd. T	Tube O.D.	Hose size	A		D		EØ		H		②	
							mm	in	mm	in	mm	in	mm	in		mm
1A6DLA4	1S6DLA4	1G6DLA4	—	M14 x 1.5	8	-04	62,4	2.46	39,0	1.53	4,2	0.16	17,5	0.69	17,0	0.67
1A8DLA4	1S8DLA4	—	—	M16 X 1.5	10	-04	64,8	2.55	41,5	1.63	0,4	0.17	18,4	0.72	19,0	0.75
1A8DLA6	1S8DLA6	1G8DLA6	—	M16 x 1.5	10	-06	66,8	2.63	41,5	1.63	6,7	0.26	19,0	0.75	19,0	0.75
1A10DLA6	1S10DLA6	1G10DLA6	—	M18 x 1.5	12	-06	69,8	2.75	44,5	1.75	6,7	0.26	20,5	0.81	22,0	0.87
1A12DLA8	1S12DLA8	1G12DLA8	—	M22 x 1.5	15	-08	81,7	3.22	52,0	2.05	9,6	0.38	21,5	0.85	27,0	1.06
1A16DLA10	1S16DLA10	1G16DLA10	—	M26 x 1.5	18	-10	88,4	3.48	59,0	2.32	12,8	0.50	27,5	1.08	32,0	1.26
1A20DLA12	1S20DLA12	1G20DLA12	—	M30 x 2	22	-12	98,4	3.87	68,2	2.68	15,5	0.61	26,0	1.02	36,0	1.42
1A25DLA16	1S25DLA16	1G25DLA16	—	M36 x 2	28	-16	120,0	4.72	85,6	3.37	20,7	0.81	33,5	1.32	41,0	1.61
1A32DLA20	—	—	—	M45 x 2	35	-20	148,0	5.83	104,0	4.09	26,6	1.05	43,0	1.69	50,0	1.97

Crimp fittings

Braided, low pressure and four spiral
(TTC / 1SA / 1GA / TTC-12 Series)

H

DKO female swivel, light duty, 90° elbow (DLB)

1 Global TTC fittings

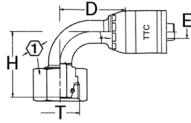

For use with hose:
2661(-12 thru -32), FC310, FC510, FC579, FC611, FC619 (-12 thru -32), FC639/FC839B, FC693, FC735, FC849/FC849B, GH120, GH194, GH195, GH663, GH681, GH781, GH793.

2 Global nipples

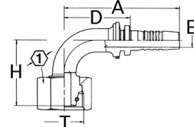

For use with hose:
Clamp: 2661 (-12 thru -20), FC619 (-12 thru -20).
Socket 1SA: 2681, FC310, FC510, FC639/FC839B (-4 thru -8), GH194 (-4 thru -20), GH663, GH681.
Socket 1SB: 2781, FC466, FC195, FC498, FC598, FC579, FC639/FC839B (-10 thru -16), FC735 (-4 thru -20), FC849/FC849B (-06 thru -12), GH120 (-4 thru -20), GH195, GH781 (-04 thru -20), GH793, 2766.

3 Global OTC fittings

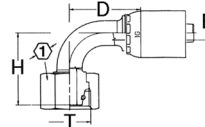

For use with hose:
2583, 2661, FC466, FC498, FC598, FC619, FC699.

4 Global TTC12 fittings

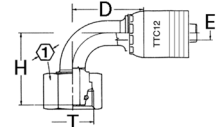

For use with hose:
FC636, FC736, GH493, EC525.

1 TTC part #	2 Nipple part #	3 OTC part #	4 TTC12 part #	Thd. T	Tube O.D.	Hose size	A		D		EØ		H		1
							mm	in	mm	in	mm	in	mm	in	
1A5DLB4	1S5DLB4	1G5DLB4	—	M12 x 1.5	6	-04	49,9	1.96	26,5	1.04	4,2	0.16	26,5	1.04	17,0 0.67
1A6DLB4	1S5DLB4	1G6DLB4	—	M14 x 1.5	8	-04	51,9	2.04	28,5	1.12	4,2	0.16	31,5	1.24	17,0 0.67
1A8DLB4	1S8DLB4	—	—	M16 x 1.5	10	-04	55,4	2.18	32,0	1.26	4,3	0.17	35,5	1.40	19,0 0.75
1A8DLB6	1S8DLB6	1G8DLB6	1B8DLB6	M16 x 1.5	10	-06	57,3	2.25	32,0	1.26	6,7	0.26	35,5	1.40	19,0 0.75
1A10DLB6	1S10DLB6	1G10DLB6	—	M18 x 1.5	12	-06	60,3	2.37	35,0	1.38	6,7	0.26	39,0	1.53	22,0 0.87
1A12DLB8	1S12DLB8	1G12DLB8	1B12DLB8	M22 x 1.5	15	-08	72,0	2.83	42,3	1.66	9,6	0.38	43,0	1.69	27,0 1.06
1A16DLB10	1S16DLB10	1G16DLB10	—	M26 x 1.5	18	-10	82,9	3.26	53,5	2.11	12,8	0.50	59,0	2.32	32,0 1.26
1A20DLB12	1S20DLB12	1G20DLB12	1B20DLB12	M30 x 2	22	-12	95,0	3.74	64,8	2.55	15,5	0.61	54,0	2.12	36,0 1.42
1A25DLB16	1S25DLB16	1G25DLB16	—	M36 x 2	28	-16	154,4	6.08	120,0	4.72	20,7	0.81	71,0	2.79	41,0 1.61
1A32DLB20	—	—	—	M45 x 2	35	-20	119,0	4.68	75,0	2.95	26,6	1.05	76,0	2.99	50,0 1.97

24° male, light duty (DK)

1 Global TTC fittings

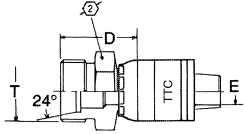

For use with hose:
2661(-12 thru -32), FC310, FC510, FC579, FC611, FC619 (-12 thru -32), FC639/FC839B, FC693, FC735, FC849/FC849B, GH120, GH194, GH195, GH663, GH681, GH781, GH793.

2 Global nipples

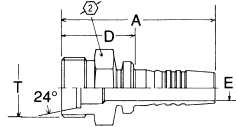

For use with hose:
Clamp: 2661 (-12 thru -20), FC619 (-12 thru -20).
Socket 1SA: 2681, FC310, FC510, FC639/FC839B (-4 thru -8), GH194 (-4 thru -20), GH663, GH681.
Socket 1SB: 2781, FC466, FC195, FC498, FC598, FC579, FC639/FC839B (-10 thru -16), FC735 (-4 thru -20), FC849/FC849B (-06 thru -12), GH120 (-4 thru -20), GH195, GH781 (-04 thru -20), GH793, 2766.

3 Global OTC fittings

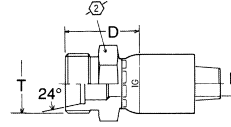

For use with hose:
2583, 2661, FC466, FC498, FC598, FC619, FC699.

4 Global TTC12 fittings

No offering

1 TTC part #	2 Nipple part #	3 OTC part #	4 TTC12 part #	Thd. T	Tube O.D.	Hose size	A		D		EØ			
							mm	in	mm	in	mm	in		mm
1A5DK4	1S5DK4	1G5DK4	—	M12 x 1.5	6	-04	44,7	1.76	21,3	0.84	4,2	0.16	12,0	0.47
1A6DK4	1S6DK4	1G6DK4	—	M14 x 1.5	8	-04	44,5	1.75	21,1	0.83	4,2	0.16	14,0	0.55
1A8DK4	1S8DK4	—	—	M16 X 1.5	10	-04	46,0	1.81	22,6	0.89	4,3	0.17	17,0	0.67
1A8DK6	1S8DK6	1G8DK6	—	M16 x 1.5	10	-06	52,0	2.05	26,7	1.05	6,7	0.26	17,0	0.67
1A10DK6	1S10DK6	1G10DK6	—	M18 x 1.5	12	-06	49,0	1.93	23,7	0.93	6,7	0.26	19,0	0.75
1A12DK8	1S12DK8	1G12DK8	—	M22 x 1.5	15	-08	56,0	2.20	26,3	1.03	9,6	0.38	24,0	0.94
1A16DK10	1S16DK10	1G16DK10	—	M26 x 1.5	18	-10	56,0	2.20	26,6	1.05	12,8	0.50	27,0	1.06
1A20DK12	1S20DK12	1G20DK12	—	M30 x 2	22	-12	62,0	2.44	31,8	1.25	15,5	0.61	32,0	1.26
1A25DK16	1S25DK16	1G25DK16	—	M36 x 2	28	-16	66,0	2.60	31,6	1.24	20,7	0.81	41,0	1.61
1A32DK20	1S32DK20	1G32DK20	—	M45 x 2	35	-20	79,4	3.12	35,4	1.39	26,6	1.05	46,0	1.81

Crimp fittings

Braided, low pressure and four spiral
(TTC / 1SA / 1GA / TTC-12 Series)

H

DKO female swivel, heavy duty (DS)

1 Global TTC fittings

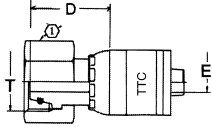

For use with hose:
2661(-12 thru -32), FC310, FC510, FC579, FC611, FC619 (-12 thru -32), FC639/FC839B, FC693, FC735, FC849/FC849B, GH120, GH194, GH195, GH663, GH681, GH781, GH793.

2 Global nipples

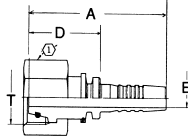

For use with hose:
Clamp: 2661 (-12 thru -20), FC619 (-12 thru -20).
Socket 1SA: 2681, FC310, FC510, FC639/FC839B (-4 thru -8), GH194 (-4 thru -20), GH663, GH681.
Socket 1SB: 2781, FC466, FC195, FC498, FC598, FC579, FC639/FC839B (-10 thru -16), FC735 (-4 thru -20), FC849/FC849B (-06 thru -12), GH120 (-4 thru -20), GH195, GH781 (-04 thru -20), GH793, 2766.

3 Global OTC fittings

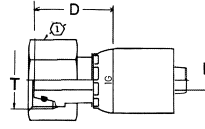

For use with hose:
2583, 2661, FC466, FC498, FC598, FC619, FC699.

4 Global TTC12 fittings

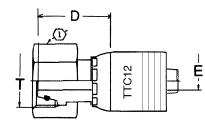

For use with hose:
FC636, FC736, GH493, EC525.

1 TTC part #	2 Nipple part #	3 OTC part #	4 TTC12 part #	Thd. T	Tube O.D.	Hose size	A		D		EØ		1	
							mm	in	mm	in	mm	in		mm
1A5DS4	1S5DS4	1G5DS4	—	M16 x 1.5	8	-04	49,6	1.95	26,2	1.03	4,2	0.16	19,0	0.75
1A6DS4	1S6DS4	1G6DS4	—	M18 x 1.5	10	-04	50,8	2.00	27,4	1.08	4,2	0.16	22,0	0.87
1A8DS4	1S8DS4	—	—	M20 X 1.5	12	-04	50,8	2.00	27,4	1.08	4,3	0.17	24,0	0.94
1A6DS6	1S6DS6	—	—	M18 X 1.5	10	-06	52,8	2.08	27,7	1.09	6,6	0.26	27,0	1.06
1A8DS6	1S8DS6	1G8DS6	1B8DS6 4S8DS6*	M20 x 1.5	12	-06	53,8	2.12	28,5	1.12	6,7	0.26	24,0	0.94
1A10DS6	1S10DS6	1G10DS6	1B10DS6 4S10DS6*	M22 x 1.5	14	-06	56,9	2.24	31,6	1.24	6,7	0.26	27,0	1.06
1A10DS8	1S10DS8	—	—	M22 x 1.5	14	-08	55,2	2.17	25,5	1.00	9,6	0.38	27,0	1.06
1A12DS8	1S12DS8	1G12DS8	1B12DS8 4S12DS8*	M24 x 1.5	16	-08	62,4	2.46	32,7	1.29	9,6	0.38	30,0	1.18
1A16DS10	1S16DS10	1G16DS10	1B16DS10 4S16DS10*	M30 x 2	20	-10	66,9	2.63	37,5	1.48	12,8	0.50	36,0	1.42
1A16DS12	1S16DS12	—	—	M30 x 2	20	-12	60,2	2.37	30,2	1.19	14,0	0.55	36,0	1.42
1A20DS12	1S20DS12	1G20DS12	1B20DS12	M36 x 2	25	-12	72,0	2.83	41,8	1.64	15,5	0.61	46,0	1.81
1A25DS16	1S25DS16	1G25DS16	1B25DS16	M42 x 2	30	-16	78,5	3.09	44,1	1.44	20,7	0.81	50,0	1.97
1A32DS20	—	—	1B32DS20	M52 x 2	38	-20	93,7	3.69	49,7	1.96	26,6	1.05	60,0	2.36

* Part number denotes 4S equivalent fitting

DKO female swivel, heavy duty, 45° elbow (DSA)

1 Global TTC fittings

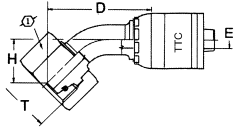

For use with hose:

2661(-12 thru -32), FC310, FC510, FC579, FC611, FC619 (-12 thru -32), FC639/FC839B, FC693, FC735, FC849/FC849B, GH120, GH194, GH195, GH663, GH681, GH781, GH793.

2 Global nipples

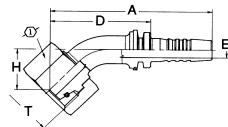

For use with hose:

Clamp: 2661 (-12 thru -20), FC619 (-12 thru -20).

Socket 1SA: 2681, FC310, FC510, FC639/FC839B (-4 thru -8), GH194 (-4 thru -20), GH663, GH681.

Socket 1SB: 2781, FC466, FC195, FC498, FC598, FC579, FC639/FC839B (-10 thru -16), FC735 (-4 thru -20), FC849/FC849B (-06 thru -12), GH120 (-4 thru -20), GH195, GH781 (-04 thru -20), GH793, 2766.

3 Global OTC fittings

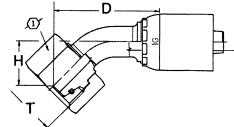

For use with hose:

2583, 2661, FC466, FC498, FC598, FC619, FC699.

4 Global TTC12 fittings

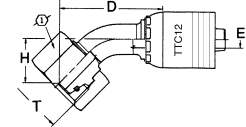

For use with hose:

FC636, FC736, GH493, EC525.

1 TTC part #	2 Nipple part #	3 OTC part #	4 TTC12 part #	Thd. T	Tube O.D.	Hose size	A		D		EØ		H		1	
							mm	in	mm	in	mm	in	mm	in		mm
1A6DSA4	1S6DSA4	1G6DSA4	—	M18 x 1.5	10	-04	61,4	2.42	38,0	1.50	4,2	0.16	17,0	0.67	22,0	0.87
1A8DSA6	1S8DSA6	1G8DSA6	1B8DSA6 4S8DSA6*	M20 x 1.5	12	-06	68,3	2.69	43,0	1.69	6,7	0.26	19,0	0.75	24,0	0.94
1A10DSA6	1S10DSA6	1G10DSA6	—	M22 x 1.5	14	-06	68,8	2.71	43,5	1.71	6,7	0.26	20,0	0.79	27,0	1.06
1A12DSA8	1S12DSA8	1G12DSA8	1B12DSA8 4S12DSA8*	M24 x 1.5	16	-08	79,7	3.14	50,0	1.97	9,6	0.38	23,0	0.90	30,0	1.18
1A16DSA10	1S16DSA10	1G16DSA10	1B16DSA10 4S16DSA10*	M30 x 2	20	-10	89,3	3.51	59,9	2.36	12,8	0.50	26,0	1.02	36,0	1.42
1A20DSA12	1S20DSA12	1G20DSA12	1B20DSA12	M36 x 2	25	-12	107,4	4.23	77,2	3.04	15,5	0.61	32,5	1.28	46,0	1.81
1A25DSA16	1S25DSA16	1G25DSA16	1B25DSA16	M42 x 2	30	-16	121,4	4.78	87,0	3.42	20,7	0.81	37,5	1.48	55,0	2.16

* Part number denotes 4S equivalent fitting.

Crimp fittings

Braided, low pressure and four spiral
(TTC / 1SA / 1GA / TTC-12 Series)

H

DKO female swivel, heavy duty, 90° elbow (DSB)

1 Global TTC fittings

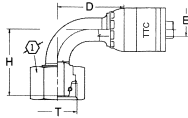

For use with hose:

2661(-12 thru -32), FC310, FC510, FC579, FC611, FC619 (-12 thru -32), FC639/FC839B, FC693, FC735, FC849/FC849B, GH120, GH194, GH195, GH663, GH681, GH781, GH793.

2 Global nipples

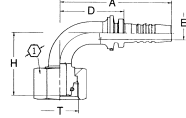

For use with hose:

Clamp: 2661 (-12 thru -20), FC619 (-12 thru -20).

Socket 1SA: 2681, FC310, FC510, FC639/FC839B (-4 thru -8), GH194 (-4 thru -20), GH663, GH681.

Socket 1SB: 2781, FC466, FC195, FC498, FC598, FC579, FC639/FC839B (-10 thru -16), FC735 (-4 thru -20), FC849/FC849B (-06 thru -12), GH120 (-4 thru -20), GH195, GH781 (-04 thru -20), GH793, 2766.

3 Global OTC fittings

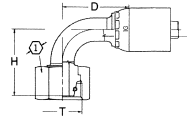

For use with hose:

2583, 2661, FC466, FC498, FC598, FC619, FC699.

4 Global TTC12 fittings

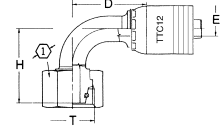

For use with hose:

FC636, FC736, GH493, EC525.

1 TTC part #	2 Nipple part #	3 OTC part #	4 TTC12 part #	Thd. T	Tube O.D.	Hose size	A		D		EØ		H		
							mm	in	mm	in	mm	in	mm	in	
1A6DSB4	1S6DSB4	1G6DSB4	—	M18 x 1.5	10	-04	54,5	2.14	31,0	1.22	4,2	0.16	33,5	1.32	22,0 0.87
1A8DSB6	1S8DSB6	1G8DSB6	1B8DSB6 4S8DSB6*	M20 x 1.5	12	-06	55,9	2.20	34,6	1.36	6,7	0.26	35,3	1.39	24,0 0.94
1A10DSB6	1S10DSB6	1G10DSB6	1B10DSB6 4S10DSB6*	M22 x 1.5	14	-06	59,8	2.35	38,5	1.52	6,7	0.26	42,0	1.65	27,0 1.06
1A12DSB8	1S12DSB8	1G12DSB8	1B12DSB8 4S12DSB8*	M24 x 1.5	16	-08	77,7	3.06	48,0	1.89	9,6	0.38	45,3	1.78	30,0 1.18
1A16DSB10	1S16DSB10	1G16DSB10	1B16DSB10 4S16DSB10*	M30 x 2	20	-10	82,0	3.23	52,6	2.07	12,8	0.50	52,0	2.05	36,0 1.42
1A20DSB12	1S20DSB12	1G20DSB12	1B20DSB12	M36 x 2	25	-12	93,0	3.66	62,8	2.47	15,5	0.61	64,5	2.54	46,0 1.81
1A25DSB16	1S25DSB16	1G25DSB16	1B25DSB16	M42 x 2	30	-16	104,0	4.09	69,6	2.74	20,7	0.81	74,0	2.91	50,0 1.97

* Part number denotes 4S equivalent fitting.

24° male, heavy duty (EK)

1 Global TTC fittings

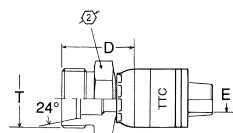

For use with hose:

2661(-12 thru -32), FC310, FC510, FC579, FC611, FC619 (-12 thru -32), FC639/FC839B, FC693, FC735, FC849/FC849B, GH120, GH194, GH195, GH663, GH681, GH781, GH793.

2 Global nipples

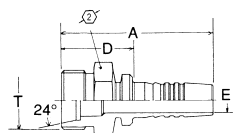

For use with hose:

Clamp: 2661 (-12 thru -20), FC619 (-12 thru -20).

Socket 1SA: 2681, FC310, FC510, FC639/FC839B (-4 thru -8), GH194 (-4 thru -20), GH663, GH681.

Socket 1SB: 2781, FC466, FC195, FC498, FC598, FC579, FC639/FC839B (-10 thru -16), FC735 (-4 thru -20), FC849/FC849B (-06 thru -12), GH120 (-4 thru -20), GH195, GH781 (-04 thru -20), GH793, 2766.

3 Global OTC fittings

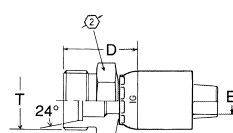

For use with hose:

2583, 2661, FC466, FC498, FC598, FC619, FC699.

4 Global TTC12 fittings

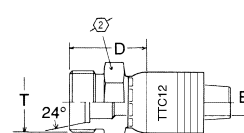

For use with hose:

FC636, FC736, GH493, EC525.

1 TTC part #	2 Nipple part #	3 OTC part #	4 TTC12 part #	Thd. T	Tube O.D.	Hose size	A		D		EØ			
							mm	in	mm	in	mm	in		mm
1A4EK4	1S4EK4	—	—	M12 x 1.5	6	-04	44,7	1.76	21,3	0.84	4,2	0.16	12,0	0.47
1A5EK4	1S5EK4	1G5EK4	—	M16 x 1.5	8	-04	47,5	1.87	24,1	0.95	4,2	0.16	17,0	0.67
1A6EK4	1S6EK4	1G6EK4	—	M18 x 1.5	10	-04	40,7	1.60	23,6	0.93	4,2	0.16	19,0	0.75
1A6EK6	1S6EK6	—	1B6EK6 4S6EK6*	M18 x 1.5	10	-06	45,5	1.79	24,2	0.95	6,7	0.26	19,0	0.75
1A8EK6	1S8EK6	1G8EK6	1B8EK6 4S8EK6*	M20 x 1.5	12	-06	50,3	1.98	25,0	0.98	6,7	0.26	22,0	0.87
1A10EK6	1S10EK6	1G10EK6	1B10EK6	M22 x 1.5	14	-06	52,6	2.07	27,3	1.07	6,7	0.26	24,0	0.94
1A12EK8	1S12EK8	1G12EK8	1B12EK8 4S12EK8*	M24 x 1.5	16	-08	58,0	2.28	28,3	1.11	9,6	0.38	27,0	1.06
1A16EK10	1S16EK10	1G16EK10	1B16EK10 4S16EK10*	M30 x 2	20	-10	62,0	2.44	32,7	1.29	12,8	0.50	32,0	1.26
1A16EK12	1S16EK12	—	—	M30 x 2	20	-12	57,7	2.27	30,7	1.21	15,5	0.61	32,0	1.26
1A20EK12	1S20EK12	1G20EK12	1B20EK12	M36 x 2	25	-12	65,5	2.58	35,3	1.39	15,5	0.61	41,0	1.61
1A25EK16	1S25EK16	1G25EK16	1B25EK16	M42 x 2	30	-16	72,3	2.85	37,9	1.49	20,7	0.81	46,0	1.81

* Part number denotes 4S equivalent fitting.

Crimp fittings

Braided, low pressure and four spiral (TTC / 1SA / 1GA / TTC-12 Series)

H

JIS female swivel (JF)

1 Global TTC fittings

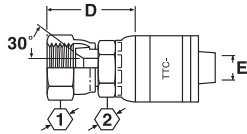

For use with hose:
2661(-12 thru -32), FC310, FC510, FC579, FC611, FC619 (-12 thru -32), FC639/FC839B, FC693, FC735, FC849/FC849B, GH120, GH194, GH195, GH663, GH681, GH781, GH793.

2 Global nipples

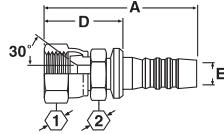

For use with hose:
Clamp: 2661 (-12 thru -20), FC619 (-12 thru -20).
Socket 1SA: 2681, FC310, FC510, FC639/FC839B (-4 thru -8), GH194 (-4 thru -20), GH663, GH681.
Socket 1SB: 2781, FC466, FC195, FC498, FC598, FC579, FC639/FC839B (-10 thru -16), FC735 (-4 thru -20), FC849/FC849B (-06 thru -12), GH120 (-4 thru -20), GH195, GH781 (-04 thru -20), GH793, 2766.

3 Global OTC fittings

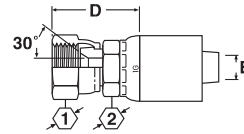

For use with hose:
2583, 2661, FC466, FC498, FC598, FC619, FC699.

4 Global TTC12 fittings

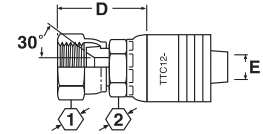

For use with hose:
FC636, FC736, GH493, EC525.

1 TTC part #	2 Nipple part #	3 OTC part #	4 TTC12 part #	Thd.	Hose size	A		D		EØ		1		2	
						mm	in	mm	in	mm	in	mm	in	mm	in
1A4JF4	1S4JF4	1G4JF4	—	G 7/16 -20	-04	53,2	2.09	27,3	1.08	4,2	0.17	19,0	0.75	19,0	0.75
1A6JF6	1S6JF6	1G6JF6	1B6JF6 4S6JF6*	G 3/8 -19	-06	55,2	2.17	33,9	1.33	6,7	0.26	22,0	0.87	22,0	0.87
1A8JF8	1S8JF8	1G8JF8	1B8JF8 4S8JF8*	G 1/2 -14	-08	64,4	2.54	37,1	1.46	9,6	0.38	27,0	1.06	27,0	1.06
1A12JF10	1S12JF10	—	—	G 3/4 -14	-10	70,6	2.78	45,2	1.78	12,7	0.50	32,0	1.26	36,0	1.42
1A12JF12	1S12JF12	1G12JF12	1B12JF12	G 3/4 -14	-12	73,3	2.88	43,1	1.70	15,5	0.61	32,0	1.26	36,0	1.42
1A16JF16	1S16JF16	1G16JF16	1B16JF16	G 1 -11	-16	83,6	3.29	49,2	1.94	20,7	0.81	41,0	1.61	41,0	1.61
1A20JF20	1S20JF20	1G20JF20	1B20JF20	G 1 1/4 -11	-20	102,1	4.02	58,1	2.29	26,6	1.05	50,0	1.97	46,0	1.81

* Part number denotes 4S equivalent fitting
G as part of thread size is ISO Designation for parallel thread.

Komatsu female swivel (KF)

1 Global TTC fittings

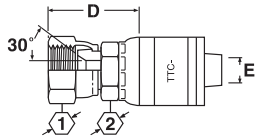

For use with hose:
2661(-12 thru -32), FC310,
FC510, FC579, FC611, FC619
(-12 thru -32), FC639/FC839B,
FC693, FC735, FC849/
FC849B, GH120, GH194,
GH195, GH663, GH681,
GH781, GH793.

2 Global nipples

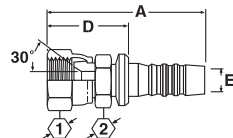

For use with hose:
Clamp: 2661 (-12 thru -20),
FC619 (-12 thru -20).
Socket 1SA: 2681, FC310,
FC510, FC639/ FC839B (-4
thru -8), GH194 (-4 thru -20),
GH663, GH681.
Socket 1SB: 2781, FC466,
FC195, FC498, FC598,
FC579, FC639/FC839B (-10
thru -16), FC735 (-4 thru -20),
FC849/FC849B (-06 thru -12),
GH120 (-4 thru -20), GH195,
GH781 (-04 thru -20), GH793,
2766.

3 Global OTC fittings

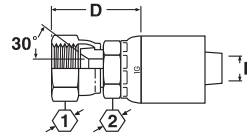

For use with hose:
2583, 2661, FC466, FC498,
FC598, FC619, FC699.

4 Global TTC12 fittings

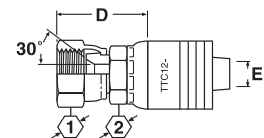

For use with hose:
FC636, FC736, GH493,
EC525.

1 TTC part #	2 Nipple part #	3 OTC part #	4 TTC12 part #	Thd.	Hose size	A		D		EØ		①		②	
						mm	in	mm	in	mm	in	mm	in	mm	in
1A4KF4	1S4KF4	1G4KF4	—	M14 x 1.5	-04	56,1	2.21	32,7	1.29	42,2	1.66	19,0	0.75	19,0	0.75
1A6KF6	1S6KF6	1G6KF6	—	M18 x 1.5	-06	60,4	2.38	35,1	1.38	6,7	0.26	24,0	0.94	22,0	0.87
1A8KF8	1S8KF8	1G8KF8	1B8KF8 4S8KF8*	M22 x 1.5	-08	67,1	2.64	39,8	1.57	9,6	0.38	27,0	1.06	27,0	1.06
1A10KF10	1S10KF10	1G10KF10	1B10KF10 4S10KF10*	M24 x 1.5	-10	72,1	2.84	46,0	1.81	12,4	0.49	30,0	1.19	31,75	1.18
1A10KF12	1S10KF12	1G10KF12	—	M24 x 1.5	-12	76,6	3.01	46,4	1.83	12,4	0.49	32,0	1.26	30,0	1.18
1A12KF12	1S12KF12	1G12KF12	1B12KF12	M30 x 1.5	-12	81,5	3.21	51,3	2.02	15,5	0.61	36,0	1.42	36,0	1.42
1A16KF16	1S16KF16	1G16KF16	1B16KF16	M33 x 1.5	-16	91,4	3.60	57,0	2.24	20,7	0.81	41,0	1.61	41,0	1.61
1A20KF20	1S20KF20	1G20KF20	1B20KF20	M36 x 1.5	-20	113,4	4.46	69,4	2.73	26,6	1.05	46,0	1.81	46,0	1.81

* Part number denotes 4S equivalent fitting

Crimp fittings

Braided, low pressure and four spiral
(TTC / 1SA / 1GA / TTC-12 Series)

H

SAE code 61 split flange (FL)

1 Global TTC fittings

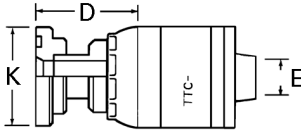

For use with hose:
2661(-12 thru -32), FC310, FC510, FC579, FC611, FC619 (-12 thru -32), FC639/FC839B, FC693, FC735, FC849/FC849B, GH120, GH194, GH195, GH663, GH681, GH781, GH793.

2 Global nipples

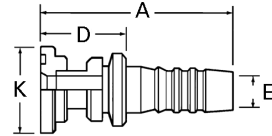

For use with hose:
Clamp: 2661 (-12 thru -20), FC619 (-12 thru -20).
Socket 1SA: 2681, FC310, FC510, FC639/FC839B (-4 thru -8), GH194 (-4 thru -20), GH663, GH681.
Socket 1SB: 2781, FC466, FC195, FC498, FC598, FC579, FC639/FC839B (-10 thru -16), FC735 (-4 thru -20), FC849/FC849B (-06 thru -12), GH120 (-4 thru -20), GH195, GH781 (-04 thru -20), GH793, 2766.

3 Global OTC fittings

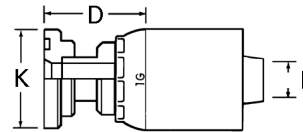

For use with hose:
2583, 2661, FC466, FC498, FC598, FC619, FC699.

4 Global TTC12 fittings

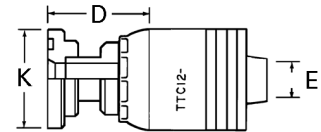

For use with hose:
FC636, FC736, GH493, EC525.

1 TTC part #	2 Nipple part #	3 OTC part #	4 TTC12 part #	Thd. Flange head Dia. K Ø	Hose size	A		D		EØ	
						mm	in	mm	in	mm	in
1A8FL8	1S8FL8	1G8FL8	1B8FL8 4S8FL8*	1.19	-08	79,5	3.13	52,3	2.06	9,6	0.38
1A12FL8	1S12FL8	1G12FL8	1B12FL8 4S12FL8*	1.50	-08	80,6	3.17	53,3	2.10	9,6	0.38
1A12FL10	1S12FL10	1G12FL10	1B12FL10 4S12FL10*	1.50	-10	79,4	3.13	53,3	2.10	12,8	0.50
1A12FL12	1S12FL12	1G12FL12	1B12FL12	1.50	-12	84,1	3.31	53,8	2.12	15,5	0.61
1A16FL12	1S16FL12	1G16FL12	1B16FL12	1.75	-12	84,1	3.31	53,8	2.12	15,5	0.61
1A20FL12	1S20FL12	1G20FL12	1B20FL12	2.00	-12	91,7	3.61	61,5	2.42	15,5	0.61
1A12FL16	1S12FL16	—	—	1.50	-16	89,0	3.50	54,4	2.14	14,7	0.58
1A16FL16	1S16FL16	1G16FL16	1B16FL16	1.75	-16	88,6	3.49	54,4	2.14	20,8	0.82
1A20FL16	1S20FL16	1G20FL16	1B20FL16	2.00	-16	96,3	3.79	62,0	2.44	20,8	0.82
1A24FL16	1S24FL16	1G24FL16	1B24FL16	2.38	-16	97,3	3.83	62,7	2.47	20,8	0.82
1A16FL20	1S16FL20	1G16FL20	1B16FL20	1.75	-20	100,1	3.94	56,1	2.21	20,8	0.82
1A20FL20	1S20FL20	1G20FL20	1B20FL20	2.00	-20	107,7	4.24	63,8	2.51	26,7	1.05

* Part number denotes 4S equivalent fitting.

SAE code 61 split flange (FL) - Cont.

1 Global TTC fittings

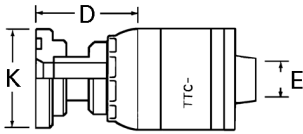

For use with hose:
2661(-12 thru -32), FC310, FC510, FC579, FC611, FC619 (-12 thru -32), FC639/FC839B, FC693, FC735, FC849/FC849B, GH120, GH194, GH195, GH663, GH681, GH781, GH793.

2 Global nipples

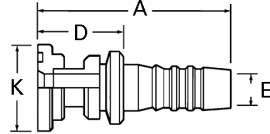

For use with hose:
Clamp: 2661 (-12 thru -20), FC619 (-12 thru -20).
Socket 1SA: 2681, FC310, FC510, FC639/FC839B (-4 thru -8), GH194 (-4 thru -20), GH663, GH681.
Socket 1SB: 2781, FC466, FC195, FC498, FC598, FC579, FC639/FC839B (-10 thru -16), FC735 (-4 thru -20), FC849/FC849B (-06 thru -12), GH120 (-4 thru -20), GH195, GH781 (-04 thru -20), GH793, 2766.

3 Global OTC fittings

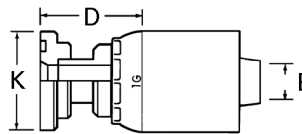

For use with hose:
2583, 2661, FC466, FC498, FC598, FC619, FC699.

4 Global TTC12 fittings

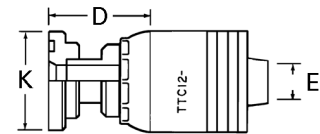

For use with hose:
FC636, FC736, GH493, EC525.

1 TTC part #	2 Nipple part #	3 OTC part #	4 TTC12 part #	Thd. Flange head Dia. K Ø	Hose size	A		D		EØ	
						mm	in	mm	in	mm	in
1A24FL20	1S24FL20	1G24FL20	1B24FL20	2.38	-20	108,5	4.27	64,5	2.54	26,7	1.05
1A32FL20	1S32FL20	1G32FL20	1B32FL20	2.81	-20	108,5	4.27	64,5	2.54	25,7	1.01
1A20FL24	1S20FL24	1G20FL24	—	2.00	-24	111,0	4.37	64,8	2.55	26,7	1.05
1A24FL24	1S24FL24	1G24FL24	1B24FL24	2.38	-24	111,8	4.40	65,5	2.58	32,0	1.26
1A32FL24	1S32FL24	1G32FL24	1B32FL24	2.81	-24	111,8	4.40	65,5	2.58	30,2	1.19
1A24FL32	1S24FL32	1G24FL32	—	2.38	-32	117,1	4.61	66,8	2.63	32,0	1.26
—	—	—	1B24FL32	2.38	-32	129,8	5.11	66,8	2.63	28,4	1.12
1A32FL32	1S32FL32	1G32FL32	—	2.81	-32	117,1	4.61	66,8	2.63	44,5	1.75
—	—	—	1B32FL32	2.81	-32	129,8	5.11	66,8	2.63	41,4	1.62
1A40FL32	1S40FL32	1G40FL32	—	3.31	-32	116,8	4.60	66,8	2.63	44,5	1.75
—	—	—	1B40FL32	3.31	-32	129,8	5.11	66,8	2.63	41,4	1.62

For flanges, split flange halves, kits and o-rings, see pages H-87-H-92.

Crimp fittings

Braided, low pressure and four spiral
(TTC / 1SA / 1GA / TTC-12 Series)

H

SAE code 61 split flange 45° elbow (FLA)

1 Global TTC fittings

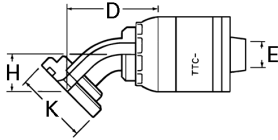

For use with hose:
2661(-12 thru -32), FC310, FC510, FC579, FC611, FC619 (-12 thru -32), FC639/FC839B, FC693, FC735, FC849/FC849B, GH120, GH194, GH195, GH663, GH681, GH781, GH793.

2 Global nipples

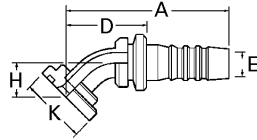

For use with hose:
Clamp: 2661 (-12 thru -20), FC619 (-12 thru -20).
Socket 1SA: 2681, FC310, FC510, FC639/FC839B (-4 thru -8), GH194 (-4 thru -20), GH663, GH681.
Socket 1SB: 2781, FC466, FC195, FC498, FC598, FC579, FC639/FC839B (-10 thru -16), FC735 (-4 thru -20), FC849/FC849B (-06 thru -12), GH120 (-4 thru -20), GH195, GH781 (-04 thru -20), GH793, 2766.

3 Global OTC fittings

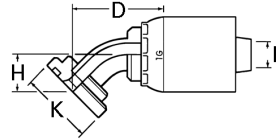

For use with hose:
2583, 2661, FC466, FC498, FC598, FC619, FC699.

4 Global TTC12 fittings

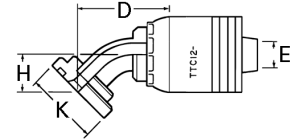

For use with hose:
FC636, FC736, GH493, EC525.

1 TTC part #	2 Nipple part #	3 OTC part #	4 TTC12 part #	Thd. Flange head Dia. K Ø	Hose size	A		D		EØ		H	
						mm	in	mm	in	mm	in	mm	in
1A8FLA8	1S8FLA8	1G8FLA8	—	1.19	-08	79,0	3.11	49,3	1.94	9,4	0.37	19,8	0.78
—	—	—	1B8FLA8 4S8FLA8*	1.19	-08	77,5	3.05	50,3	1.98	9,1	0.36	19,8	0.78
1A12FLA8	1S12FLA8	1G12FLA8	—	1.50	-08	92,5	3.64	62,7	2.47	9,4	0.37	25,4	1.00
—	—	—	1B12FLA8 4S12FLA8*	1.50	-08	90,6	3.57	63,4	2.50	9,6	0.38	25,4	1.00
1A12FLA10	1S12FLA10	1G12FLA10	—	1.50	-10	93,5	3.68	64,3	2.53	11,7	0.46	25,4	1.00
—	—	—	1B12FLA10 4S12FLA10*	1.50	-10	90,3	3.56	64,2	2.53	12,8	0.50	25,4	1.00
1A12FLA12	1S12FLA12	1G12FLA12	—	1.50	-12	93,2	3.67	63,0	2.48	14,7	0.58	25,7	1.01
—	—	—	1B12FLA12	1.50	-12	93,0	3.66	62,5	2.46	14,2	0.56	25,4	1.00
1A16FLA12	1S16FLA12	1G16FLA12	—	1.75	-12	105,7	4.16	75,4	2.97	14,7	0.58	26,9	1.06
—	—	—	1B16FLA12	1.75	-12	105,7	4.16	75,4	2.97	14,2	0.56	26,9	1.06
—	—	—	1B20FLA12	2.00	-12	93,0	3.66	62,5	2.46	14,2	0.56	25,4	1.00
1A12FLA16	1S12FLA16	—	—	1.50	-16	99,8	3.93	65,3	2.57	14,7	0.58	25,7	1.01
1A16FLA16	1S16FLA16	1G16FLA16	1B16FLA16	1.75	-16	110,5	4.35	76,2	3.00	19,3	0.76	26,9	1.06
1A20FLA16	1S20FLA16	1G20FLA16	—	2.00	-16	122,2	4.81	87,6	3.45	19,3	0.76	29,2	1.15
—	—	—	1B20FLA16	2.00	-16	122,2	4.81	87,9	3.46	19,3	0.76	29,2	1.15
—	1S16FLA20	1G16FLA20	1B16FLA20	1.75	-20	121,9	4.80	77,7	3.06	19,3	0.76	26,9	1.06
1A16FLA20	—	—	—	1.75	-20	121,9	4.80	77,7	3.06	19,3	0.76	26,9	1.06
—	1S20FLA20	1G20FLA20	—	2.00	-20	134,1	5.28	90,2	3.55	25,7	1.01	30,0	1.18
—	—	—	1B20FLA20	2.00	-20	133,6	5.26	89,4	3.52	25,7	1.01	29,2	1.15

* Part number denotes 4S equivalent fitting.

Braided, low pressure and four spiral
(TTC / ISA / IGA / TTC-12 Series)

SAE code 61 split flange 45° elbow (FLA) - Cont.

1 Global TTC fittings

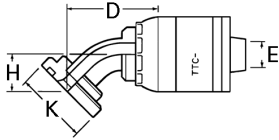

For use with hose:
2661(-12 thru -32), FC310,
FC510, FC579, FC611, FC619
(-12 thru -32), FC639/FC839B,
FC693, FC735, FC849/
FC849B, GH120, GH194,
GH195, GH663, GH681,
GH781, GH793.

2 Global nipples

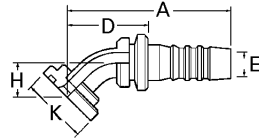

For use with hose:
Clamp: 2661 (-12 thru -20),
FC619 (-12 thru -20).
Socket 1SA: 2681, FC310,
FC510, FC639/FC839B (-4
thru -8), GH194 (-4 thru -20),
GH663, GH681.
Socket 1SB: 2781, FC466,
FC195, FC498, FC598,
FC579, FC639/FC839B (-10
thru -16), FC735 (-4 thru -20),
FC849/FC849B (-06 thru -12),
GH120 (-4 thru -20), GH195,
GH781 (-04 thru -20), GH793,
2766.

3 Global OTC fittings

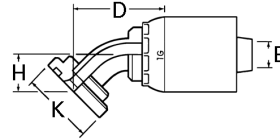

For use with hose:
2583, 2661, FC466, FC498,
FC598, FC619, FC699.

4 Global TTC12 fittings

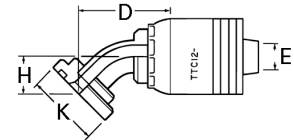

For use with hose:
FC636, FC736, GH493,
EC525.

1 TTC part #	2 Nipple part #	3 OTC part #	4 TTC12 part #	Thd. Flange head Dia. K Ø	Hose size	A		D		EØ		H	
						mm	in	mm	in	mm	in	mm	in
1A20FLA20	—	—	—	2.00	-20	134,1	5.28	90,2	3.55	25,7	1.01	30,0	1.18
1A24FLA20	1S24FLA20	1G24FLA20	1B24FLA20	2.37	-20	150,9	5.94	106,7	4.20	25,7	1.01	35,8	1.41
1A20FLA24	1S20FLA24	1G20FLA24	—	2.00	-24	115,3	4.54	69,1	2.72	32,0	1.26	27,4	1.08
1A24FLA24	1S24FLA24	1G24FLA24	—	2.37	-24	154,2	6.07	108,0	4.25	32,0	1.26	35,8	1.41
—	—	—	1B24FLA24	2.37	-24	154,2	6.07	108,0	4.25	30,2	1.19	35,8	1.41
1A32FLA24	1S32FLA24	—	—	2.81	-24	154,2	6.07	108,0	4.25	32,0	1.26	35,8	1.41
—	—	—	1B32FLA24	2.81	-24	185,4	7.30	138,9	5.47	30,2	1.19	50,8	2.00
1A24FLA32	1S24FLA32	1G24FLA32	—	2.37	-32	159,3	6.27	109,0	4.29	32,0	1.26	35,8	1.41
1A32FLA32	1S32FLA32	1G32FLA32	—	2.81	-32	190,2	7.49	140,2	5.52	44,5	1.75	50,8	2.00
—	—	—	1B32FLA32	2.81	-32	191,3	7.53	128,3	5.05	41,4	1.62	50,8	2.00
1A40FLA32	1S40FLA32	1G40FLA32	—	3.31	-32	133,9	5.27	83,6	3.29	44,5	1.75	33,0	1.30

For flanges, split flange halves, kits and o-rings, see pages H-87-H-92.

Crimp fittings

Braided, low pressure and four spiral
(TTC / 1SA / 1GA / TTC-12 Series)

H

SAE code 61 split flange 90° elbow (FLB)

1 Global TTC fittings

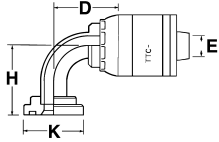

For use with hose:
2661(-12 thru -32), FC310, FC510, FC579, FC611, FC619 (-12 thru -32), FC639/FC839B, FC693, FC735, FC849/FC849B, GH120, GH194, GH195, GH663, GH681, GH781, GH793.

2 Global nipples

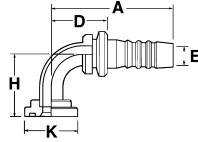

For use with hose:
Clamp: 2661 (-12 thru -20), FC619 (-12 thru -20).
Socket 1SA: 2681, FC310, FC510, FC639/FC839B (-4 thru -8), GH194 (-4 thru -20), GH663, GH681.
Socket 1SB: 2781, FC466, FC195, FC498, FC598, FC579, FC639/FC839B (-10 thru -16), FC735 (-4 thru -20), FC849/FC849B (-06 thru -12), GH120 (-4 thru -20), GH195, GH781 (-04 thru -20), GH793, 2766.

3 Global OTC fittings

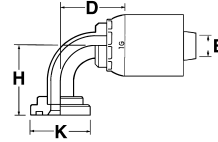

For use with hose:
2583, 2661, FC466, FC498, FC598, FC619, FC699.

4 Global TTC12 fittings

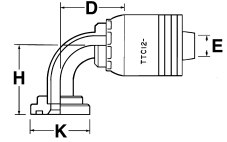

For use with hose:
FC636, FC736, GH493, EC525.

1 TTC part #	2 Nipple part #	3 OTC part #	4 TTC12 part #	Thd. Flange head Dia. K Ø	Hose size	A		D		EØ		H	
						mm	in	mm	in	mm	in	mm	in
1A8FLB8	1S8FLB8	1G8FLB8	—	1.19	—08	72,6	2.86	42,3	1.69	9,4	0.37	41,4	1.63
—	—	—	1B8FLB8 4S8FLB8*	1.19	—08	69,5	2.74	42,3	1.67	9,1	0.36	41,4	1.63
1A12FLB8	1S12FLB8	1G12FLB8	—	1.50	—08	87,6	3.45	57,9	2.28	9,4	0.37	54,1	2.13
—	—	—	1B12FLB8 4S12FLB8*	1.50	—08	85,1	3.35	57,9	2.28	9,6	0.38	54,1	2.13
1A12FLB10	1S12FLB10	1G12FLB10	—	1.50	—10	87,4	3.44	58,2	2.29	12,7	0.50	54,1	2.13
—	—	—	1B12FLB10 4S12FLB10*	1.50	—10	84,2	3.31	58,1	2.29	12,8	0.50	54,1	2.13
1A12FLB12	1S12FLB12	1G12FLB12	—	1.50	—12	88,6	3.49	58,4	2.30	14,7	0.58	54,1	2.13
—	—	—	1B12FLB12	1.50	—12	88,6	3.49	58,4	2.30	14,2	0.56	54,1	2.13
1A16FLB12	1S16FLB12	1G16FLB12	—	1.75	—12	102,4	4.03	72,1	2.84	14,7	0.58	60,5	2.38
—	—	—	1B16FLB12	1.75	—12	102,4	4.03	72,1	2.84	14,2	0.56	60,5	2.38
1A20FLB12	1S20FLB12	—	—	2.00	—12	118,6	4.67	88,4	3.48	14,7	0.58	66,5	2.62
—	—	—	1B20FLB12	2.00	—12	88,6	3.49	58,4	2.30	14,2	0.56	66,5	2.62
1A12FLB16	1S12FLB16	1G12FLB16	—	1.50	—16	106,7	4.20	72,4	2.85	19,3	0.76	55,1	2.17
1A16FLB16	1S16FLB16	1G16FLB16	—	1.75	—16	107,2	4.22	72,6	2.86	19,3	0.76	60,5	2.38
—	—	—	1B16FLB16	1.75	—16	107,2	4.22	72,9	2.87	19,3	0.76	60,5	2.38
1A20FLB16	1S20FLB16	1G20FLB16	—	2.00	—16	123,2	4.85	89,0	3.50	19,3	0.76	66,5	2.62
—	—	—	1B20FLB16	2.00	—16	123,4	4.86	89,0	3.50	19,3	0.76	66,5	2.62
1A24FLB16	1S24FLB16	1G24FLB16	1B24FLB16	2.37	—16	142,0	5.59	107,7	4.24	19,3	0.76	79,2	3.12
1A16FLB20	1S16FLB20	1G16FLB20	1B16FLB20	1.75	—20	118,4	4.66	74,4	2.93	19,3	0.76	60,5	2.38
1A20FLB20	1S20FLB20	1G20FLB20	1B20FLB20	2.00	—20	134,6	5.30	90,7	3.57	25,7	1.01	66,5	2.62
—	1S24FLB20	1G24FLB20	1B24FLB20	2.37	—20	153,4	6.04	109,5	4.31	25,7	1.01	79,2	3.12

* Part number denotes 4S equivalent fitting

SAE code 61 split flange 90° elbow (FLB) - Cont.

1 Global TTC fittings

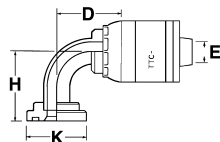

For use with hose:
2661(-12 thru -32), FC310, FC510, FC579, FC611, FC619 (-12 thru -32), FC639/FC839B, FC693, FC735, FC849/FC849B, GH120, GH194, GH195, GH663, GH681, GH781, GH793.

2 Global nipples

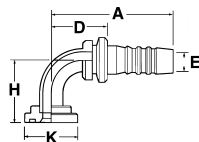

For use with hose:
Clamp: 2661 (-12 thru -20), FC619 (-12 thru -20).
Socket 1SA: 2681, FC310, FC510, FC639/FC839B (-4 thru -8), GH194 (-4 thru -20), GH663, GH681.
Socket 1SB: 2781, FC466, FC195, FC498, FC598, FC579, FC639/FC839B (-10 thru -16), FC735 (-4 thru -20), FC849/FC849B (-06 thru -12), GH120 (-4 thru -20), GH195, GH781 (-04 thru -20), GH793, 2766.

3 Global OTC fittings

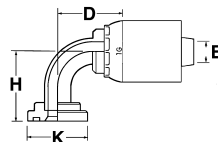

For use with hose:
2583, 2661, FC466, FC498, FC598, FC619, FC699.

4 Global TTC12 fittings

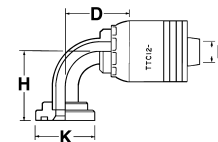

For use with hose:
FC636, FC736, GH493, EC525.

1 TTC part #	2 Nipple part #	3 OTC part #	4 TTC12 part #	Thd. Flange head Dia. K Ø	Hose size	A		D		E Ø		H	
						mm	in	mm	in	mm	in	mm	in
1A24FLB20	—	—	—	2.37	-20	153,4	6.04	109,5	4.31	25,7	1.01	79,2	3.12
—	1S32FLB20	1G32FLB20	—	2.81	-20	108,0	4.25	64,0	2.52	25,7	1.01	65,0	2.56
1A16FLB24	1S16FLB24	1G16FLB24	—	1.75	-24	121,9	4.80	75,4	2.97	19,3	0.76	60,5	2.38
—	—	—	1B16FLB24	1.75	-24	121,4	4.78	75,2	2.96	19,3	0.76	60,2	2.37
1A20FLB24	1S20FLB24	1G20FLB24	—	2.00	-24	137,9	5.43	91,7	3.61	25,7	1.01	66,5	2.62
1A24FLB24	1S24FLB24	1G24FLB24	—	2.37	-24	157,0	6.18	110,5	4.35	32,0	1.26	79,2	3.12
—	—	—	1B24FLB24	2.37	-24	157,0	6.18	110,5	4.35	30,2	1.19	79,2	3.12
1A32FLB24	1S32FLB24	1G32FLB24	—	2.81	-24	184,9	7.28	138,4	5.45	32,0	1.26	114,3	4.50
—	—	—	1B32FLB24	2.81	-24	184,9	7.28	138,4	5.45	30,2	1.19	114,3	4.50
1A24FLB32	1S24FLB32	—	—	2.37	-32	161,8	6.37	111,8	4.40	32,0	1.26	79,2	3.12
—	—	—	1B24FLB32	2.37	-32	174,0	6.85	111,0	4.37	28,4	1.12	79,2	3.12
1A32FLB32	1S32FLB32	1G32FLB32	—	2.81	-32	189,7	7.47	139,4	5.49	44,5	1.75	114,3	4.50
—	—	—	1B32FLB32	2.81	-32	182,9	7.20	119,9	4.72	41,4	1.62	114,3	4.50
1A40FLB32	1S40FLB32	1G40FLB32	—	3.31	-32	189,7	7.47	139,4	5.49	44,5	1.75	115,8	4.56
—	—	—	1B40FLB32	3.31	-32	182,9	7.20	119,9	4.72	41,4	1.62	115,8	4.56

For flanges, split flange halves, kits and o-rings, see pages H-87-H-92.

Crimp fittings

Braided, low pressure and four spiral
(TTC / 1SA / 1GA / TTC-12 Series)

H

SAE code 61 split flange 22 1/2° elbow (FLD)

1 Global TTC fittings

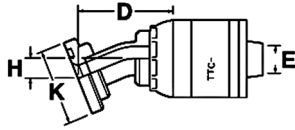

For use with hose:
2661(-12 thru -32), FC310, FC510, FC579, FC611, FC619 (-12 thru -32), FC639/FC839B, FC693, FC735, FC849/FC849B, GH120, GH194, GH195, GH663, GH681, GH781, GH793.

2 Global nipples

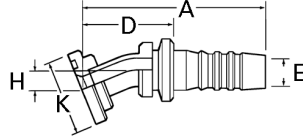

For use with hose:
Clamp: 2661 (-12 thru -20), FC619 (-12 thru -20).
Socket 1SA: 2681, FC310, FC510, FC639/FC839B (-4 thru -8), GH194 (-4 thru -20), GH663, GH681.
Socket 1SB: 2781, FC466, FC195, FC498, FC598, FC579, FC639/FC839B (-10 thru -16), FC735 (-4 thru -20), FC849/FC849B (-06 thru -12), GH120 (-4 thru -20), GH195, GH781 (-04 thru -20), GH793, 2766.

3 Global OTC fittings

No offering

4 Global TTC12 fittings

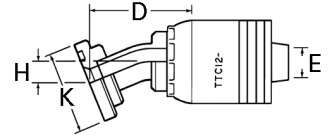

For use with hose:
FC636, FC736, GH493, EC525.

1 TTC part #	2 Nipple part #	3 OTC part #	4 TTC12 p art #	Thd. Flange head Dia. K Ø	Hose size	A		D		EØ		H	
						mm	in	mm	in	mm	in	mm	in
—	—	—	1B8FLD8 4S8FLD8*	1.19	-08	83,2	3.28	56,0	2.20	9,1	0.36	9,1	0.36
—	—	—	1B12FLD8 4S12FLD8*	1.50	-08	98,4	3.87	71,2	2.80	9,4	0.37	11,1	0.44
—	—	—	1B12FLD12	1.50	-12	101,9	4.01	71,6	2.82	14,2	0.56	11,2	0.44
—	—	—	1B16FLD12	1.75	-12	113,0	4.45	82,8	3.26	14,2	0.56	11,4	0.45
1A16FLD16	1S16FLD16	—	1B16FLD16	1.75	-16	117,9	4.64	83,6	3.29	19,3	0.76	11,4	0.45
1A20FLD16	1S20FLD16	—	1B20FLD16	2.00	-16	130,0	5.12	95,8	3.77	19,3	0.76	11,7	0.46
1A20FLD20	1S20FLD20	—	1B20FLD20	2.00	-20	141,5	5.57	97,3	3.83	25,7	1.01	11,7	0.46
—	—	—	1B24FLD20	2.37	-20	160,3	6.31	116,3	4.58	25,7	1.01	14,2	0.56
—	—	—	1B24FLD24	2.37	-24	163,8	6.45	117,6	4.63	30,2	1.19	14,2	0.56
—	—	—	1B32FLD32	2.81	-32	54,1	2.13	117,9	4.64	41,4	1.62	22,4	0.88

For flanges, split flange halves, kits and o-rings, see pages H-87–H-92.

* Part number denotes 4S equivalent fitting.

Braided, low pressure and four spiral
(TTC / ISA / IGA / TTC-12 Series)

SAE Code 61 Split Flange 67 1/2° Elbow (FLE)

1 Global TTC fittings

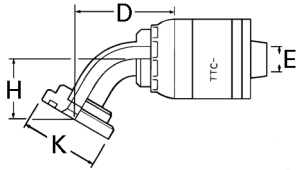

2 Global nipples

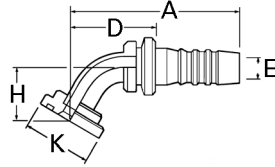

3 Global OTC fittings

No offering

4 Global TTC12 fittings

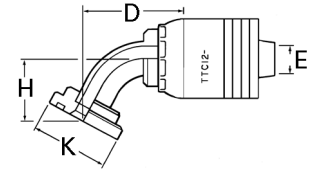

1 TTC part #	2 Nipple part #	3 OTC part #	4 TTC12 part #	Thd. Flange head Dia. K Ø	Hose size	A		D		EØ		H	
						mm	in	mm	in	mm	in	mm	in
—	—	—	1B8FLE8 4S8FLE8*	1.19	-08	84,1	3.31	56,9	2.24	9,1	0.36	32,3	1.27
—	—	—	1B12FLE12	1.50	-12	107,2	4.22	77,2	3.04	14,2	0.56	40,4	1.59
—	—	—	1B16FLE12	1.75	-12	122,9	4.84	92,7	3.65	14,2	0.56	44,2	1.74
—	—	—	1B16FLE16	1.75	-16	127,8	5.03	93,2	3.67	19,3	0.76	44,2	1.74
—	—	—	1B20FLE16	2.00	-16	145,5	5.73	111,3	4.38	19,3	0.76	46,5	1.83
1A20FLE20	1S20FLE20	—	1B20FLE20	2.00	-20	157,0	6.18	112,8	4.44	25,7	1.01	46,5	1.83
—	—	—	1B24FLE24	2.37	-24	183,1	7.21	136,9	5.39	30,2	1.19	54,4	2.14
1A24FLE20	1ST24FLE20	—	—	2.37	-24	189,7	7.47	143,5	5.65	30,2	1.19	46,0	1.81
—	—	—	1B32FLE32	2.81	-32	192,3	7.57	129,0	5.08	41,4	1.62	82,6	3.25

For flanges, split flange halves, kits and o-rings, see pages H-87-H-92.
* Part number denotes 4S equivalent fitting.

SAE code 61 split flange 30° elbow (FLF)

1 Global TTC fittings

No offering

2 Global nipples

No offering

3 Global OTC fitting

No offering

4 Global TTC12 fittings

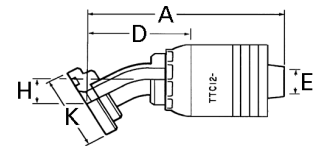

For use with hose:
FC636, FC736, GH493,
EC525.

1 TTC part #	2 Nipple part #	3 OTC part #	4 TTC12 part #	Thd. Flange head Dia. K Ø	Hose size	A		D		EØ		H	
						mm	in	mm	in	mm	in	mm	in
—	—	—	1B8FLF8 4S8FLF8*	1.19	-08	81,8	3.32	54,6	2.15	9,1	0.37	12,6	0.50
—	—	—	1B12FLF12	1.50	-12	100,1	3.94	69,9	2.75	14,2	0.56	15,7	0.62
—	—	—	1B16FLF12	1.75	-12	111,3	4.38	81,0	3.19	14,2	0.56	16,3	0.64
—	—	—	1B16FLF16	1.75	-16	116,1	4.57	81,8	3.22	19,3	0.76	16,3	0.64
—	—	—	1B20FLF16	2.00	-16	128,0	5.04	93,7	3.69	19,3	0.76	17,0	0.67
—	—	—	1B20FLF20	2.00	-20	139,4	5.49	95,5	3.76	25,7	1.01	17,0	0.67
—	—	—	1B24FLF20	2.37	-20	158,0	6.22	114,0	4.49	25,7	1.01	20,8	0.82
—	—	—	1B24FLF24	2.37	-24	161,5	6.36	115,3	4.54	30,2	1.19	20,8	0.82
—	—	—	1B32FLF32	2.81	-32	187,2	7.37	124,0	4.88	41,4	1.62	31,8	1.25
—	—	—	1B40FLF32	3.31	-32	188,5	7.42	125,2	4.93	41,4	1.62	32,5	1.28

For flanges, split flange halves, kits and o-rings, see pages H-87-H-92.
* Part number denotes 4S equivalent fitting.

Crimp fittings

Braided, low pressure and four spiral
(TTC / 1SA / 1GA / TTC-12 Series)

H

SAE code 61 split flange 60° elbow (FLG)

1 Global TTC fittings

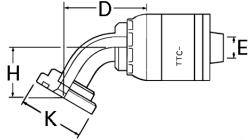

For use with hose:
2661(-12 thru -32), FC310, FC510, FC579, FC611, FC619 (-12 thru -32), FC639/FC839B, FC693, FC735, FC849/FC849B, GH120, GH194, GH195, GH663, GH681, GH781, GH793.

2 Global nipples

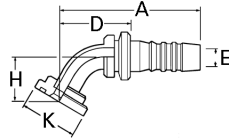

For use with hose:
Clamp: 2661 (-12 thru -20), FC619 (-12 thru -20).
Socket 1SA: 2681, FC310, FC510, FC639/FC839B (-4 thru -8), GH194 (-4 thru -20), GH663, GH681.
Socket 1SB: 2781, FC466, FC195, FC498, FC598, FC579, FC639/FC839B (-10 thru -16), FC735 (-4 thru -20), FC849/FC849B (-06 thru -12), GH120 (-4 thru -20), GH195, GH781 (-04 thru -20), GH793, 2766.

3 Global OTC fitting

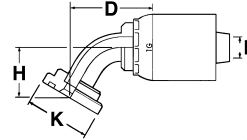

For use with hose:
2583, 2661, FC466, FC498, FC598, FC619, FC699.

4 Global TTC12 fittings

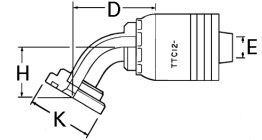

For use with hose:
FC636, FC736, GH493, EC525.

1 TTC part #	2 Nipple part #	3 OTC part #	4 TTC12 part #	Thd. Flange head Dia. K Ø	Hose size	A		D		EØ		H	
						mm	in	mm	in	mm	in	mm	in
—	—	—	1B8FLG8 4S8FLG8*	1.19	-08	88,1	3.47	60,9	2.40	9,1	0.36	28,8	1.13
—	—	—	1B12FLG12	1.50	-12	112,3	4.42	82,0	3.23	14,2	0.56	35,3	1.39
—	—	—	1B16FLG12	1.75	-12	128,3	5.05	98,0	3.86	14,2	0.56	38,4	1.51
1A16FLG16	1S16FLG16	1G16FLG16	1B16FLG16	1.75	-16	133,1	5.24	98,8	3.89	19,3	0.76	38,4	1.51
—	1S20FLG16	—	1B20FLG16	2.00	-16	151,1	5.95	116,8	4.60	19,3	0.76	39,9	1.57
—	—	—	1B20FLG20	2.00	-20	162,6	6.40	118,6	4.67	25,7	1.01	39,9	1.57
—	—	—	1B24FLG20	2.37	-20	186,4	7.34	142,5	5.61	25,7	1.01	46,0	1.81
1A24FLG24	1S24FLG24	1G24FLG24	1B24FLG24	2.37	-24	189,7	7.47	143,5	5.65	30,2	1.19	46,0	1.81
—	—	—	1B32FLG32	2.81	-32	195,1	7.68	132,1	5.20	41,4	1.62	72,9	2.87

For flanges, split flange halves, kits and o-rings, see pages H-87–H-92.
* Part number denotes 4S equivalent fitting.

SAE code 62 split flange (FH)

1 Global TTC fittings

No offering

2 Global nipples

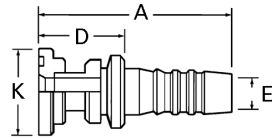

For use with hose:

Clamp: 2661 (-12 thru -20),
FC619 (-12 thru -20).

Socket 1SA: 2681, FC195,
FC310, FC510, FC639/
FC839B (-4 thru -8), GH194
(-4 thru -20), GH663, GH681.

Socket 1SB: 2781, FC466,
FC498, FC598, FC579,
FC639/FC839B (-10 thru -16),
FC735 (-4 thru -20), FC849/
FC849B (-06 thru -12), GH120
(-4 thru -20), GH195, GH781
(-04 thru -20), GH793, 2766.

3 Global OTC fitting

No offering

4 Global TTC12 fittings

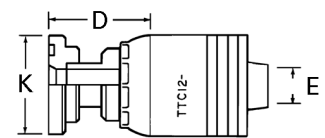

For use with hose:

FC636, FC736, GH493,
EC525.

1 TTC part #	2 Nipple part #	3 OTC part #	4 TTC12 part #	Thd. Flange head Dia. K Ø	Hose size	A		D		EØ	
						mm	in	mm	in	mm	in
—	—	—	1B8FH8 4S8FH8*	1.25	-08	79,5	3.13	52,3	2.06	9,6	0.38
—	—	—	1B12FH8 4S12FH8*	1.63	-08	80,6	3.17	53,3	2.10	9,6	0.38
—	—	—	1B12FH10 4S12FH10*	1.63	-10	79,6	3.13	53,5	2.11	12,8	0.50
—	—	—	1B12FH12	1.63	-12	84,1	3.31	53,8	2.12	15,5	0.61
—	—	—	1B16FH12	1.87	-12	84,1	3.31	53,8	2.12	15,5	0.61
—	—	—	1B16FH16	1.87	-16	89,0	3.50	54,4	2.14	20,6	0.81
—	—	—	1B20FH16	2.13	-16	96,5	3.80	62,0	2.44	20,6	0.81
1S20FH20	—	—	1B20FH20	2.13	-20	107,7	4.24	63,8	2.51	26,7	1.05
—	—	—	1B24FH20	2.50	-20	107,7	4.24	63,8	2.51	26,7	1.05
—	—	—	1B24FH24	2.50	-24	111,8	4.40	65,5	2.58	32,0	1.26
—	—	—	1B32FH32	3.12	-32	129,8	5.11	66,8	2.63	41,4	1.62

For flanges, split flange halves, kits and o-rings, see pages H-87-H-92. * Part number denotes 4S equivalent fitting.

SAE code 62 split flange 22 1/2° elbow (FHD)

1 Global TTC fittings

No offering

2 Global nipples

No offering

3 Global OTC fitting

No offering

4 Global TTC12 fittings

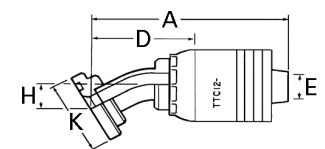

1 TTC part #	2 Nipple part #	3 OTC part #	4 TTC12 part #	Thd. Flange head Dia. K Ø	Hose size	A		D		EØ		H	
						mm	in	mm	in	mm	in	mm	in
—	—	—	1B32FHD32	3.12	-32	169,9	6.69	117,9	4.64	41,4	1.62	22,4	0.88

For flanges, split flange halves, kits and o-rings, see pages H-87-H-92.

Crimp fittings

Braided, low pressure and four spiral
(TTC / 1SA / 1GA / TTC-12 Series)

H

SAE code 62 split flange 30° elbow (FHF)

1 Global TTC fittings

No offering

2 Global nipples

No offering

3 Global OTC fitting

No offering

4 Global TTC12 fittings

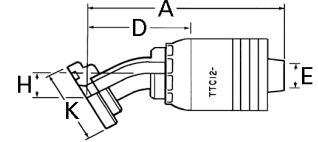

For use with hose:

FC636, FC736, GH493,
EC525.

1 Nipple part #	2 OTC part #	3 TTC part #	4 TTC12 part #	Thd. Flange head Dia. K Ø	Hose size	A		D		EØ		H	
						mm	in	mm	in	mm	in	mm	in
—	—	—	1B32FHF32	3.12	-32	176,0	6.93	124,0	4.88	41,4	1.62	31,8	1.25

For flanges, split flange halves, kits and o-rings, see pages H-87–H-92.

SAE code 62 split flange 45° elbow (FHA)

1 Global TTC fittings

No offering

2 Global nipples

No offering

3 Global OTC fitting

No offering

4 Global TTC12 fittings

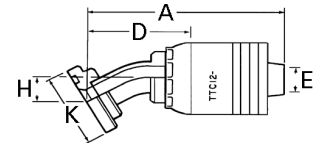

For use with hose:

FC636, FC736, GH493,
EC525.

1 TTC part #	2 Nipple part #	3 OTC part #	4 TTC12 part #	Thd. Flange head Dia. K Ø	Hose size	A		D		EØ		H	
						mm	in	mm	in	mm	in	mm	in
—	—	—	1B12FHA12	1.63	-12	93,0	3.66	62,5	2.46	14,2	0.56	25,4	1.00
—	—	—	1B16FHA16	1.87	-16	110,5	4.35	76,2	3.00	19,3	0.76	26,9	1.06
—	—	—	1B20FHA16	2.13	-16	122,2	4.81	87,9	3.46	19,3	0.76	29,2	1.15
—	—	—	1B20FHA20	2.13	-20	133,6	5.26	89,4	3.52	25,7	1.01	29,2	1.15
—	—	—	1B24FHA24	2.50	-24	154,2	6.07	108,0	4.25	30,2	1.19	35,8	1.41
—	—	—	1B32FHA32	3.12	-32	191,3	7.53	128,3	5.05	41,4	1.62	50,8	2.00

For flanges, split flange halves, kits and o-rings, see pages H-87–H-92.

SAE code 62 split flange 60° elbow (FHG)

1 Global TTC fittings

No offering

2 Global nipples

No offering

3 Global OTC fitting

No offering

4 Global TTC12 fittings

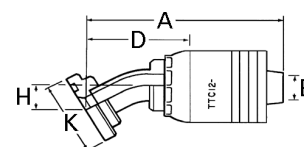

1 Nipple part #	2 OTC part #	3 TTC part #	4 TTC12 part #	Thd. Flange head Dia. K Ø	Hose size	A		D		EØ		H	
						mm	in	mm	in	mm	in	mm	in
—	—	—	1B16FHG16	1.87	-16	132,3	5.21	98,6	3.88	20,6	0.81	38,4	1.51
—	—	—	1B20FHG16	2.13	-16	150,6	5.93	116,8	4.60	20,6	0.81	39,9	1.57
—	—	—	1B32FHG32	3.12	-32	184,2	7.25	132,1	5.20	41,4	1.62	72,9	2.87

For flanges, split flange halves, kits and o-rings, see pages H-87–H-92.

SAE code 62 split flange 67 1/2° elbow (FHE)

1 Global TTC fittings

No offering

2 Global nipples

No offering

3 Global OTC fitting

No offering

4 Global TTC12 fittings

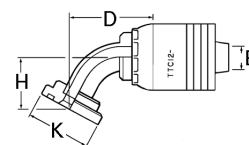

1 TTC part #	2 Nipple part #	3 OTC part #	4 TTC12 part #	Thd. Flange head Dia. K Ø	Hose size	A		D		EØ		H	
						mm	in	mm	in	mm	in	mm	in
—	—	—	1B32FHE32	3.12	-32	181,1	7.13	129,0	5.08	41,4	1.62	82,6	3.25

For flanges, split flange halves, kits and o-rings, see pages H-87–H-92.

Crimp fittings

Braided, low pressure and four spiral
(TTC / 1SA / 1GA / TTC-12 Series)

H

SAE code 62 split flange 90° elbow (FHB)

1 Global TTC fittings

No offering

2 Global nipples

No offering

3 Global OTC fitting

No offering

4 Global TTC12 fittings

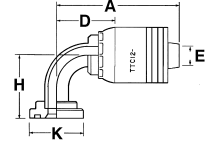

For use with hose:
FC636, FC736, GH493,
EC525.

1 TTC part #	2 Nipple part #	3 OTC part #	4 TTC12 part #	Flange head Dia. K Ø	Hose size	A		D		EØ		H	
						mm	in	mm	in	mm	in	mm	in
—	—	—	1B8FHB8 4S8FHB8*	1.25	-08	69,5	2.74	42,3	1.67	9,1	0.36	41,4	1.63
—	—	—	1B12FHB12	1.63	-12	88,6	3.49	58,4	2.30	14,2	0.56	54,1	2.13
—	—	—	1B16FHB12	1.87	-12	102,4	4.03	72,1	2.84	14,2	0.56	60,5	2.38
—	—	—	1B16FHB16	1.87	-16	107,2	4.22	72,6	2.86	19,3	0.76	60,5	2.38
—	—	—	1B20FHB16	2.13	-16	123,2	4.85	89,0	3.50	19,3	0.76	66,5	2.62
—	—	—	1B20FHB20	2.13	-20	134,6	5.30	90,7	3.57	25,7	1.01	66,5	2.62
—	—	—	1B24FHB24	2.50	-24	159,5	6.28	110,5	4.35	30,2	1.19	79,2	3.12
—	—	—	1B32FHB32	3.12	-32	182,9	7.20	119,9	4.72	41,4	1.62	114,3	4.50

For flanges, split flange halves, kits and o-rings, see pages H-87–H-92.

* Part number denotes 4S equivalent fitting.

Komatsu split flange (KS)

1 Global TTC fittings

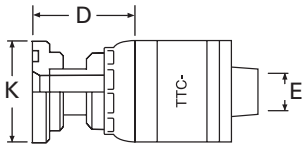

For use with hose:

2661(-12 thru -32), FC310, FC510, FC579, FC611, FC619 (-12 thru -32), FC639/FC839B, FC693, FC735, FC849/FC849B, GH120, GH194, GH195, GH663, GH681, GH781, GH793.

2 Global nipples

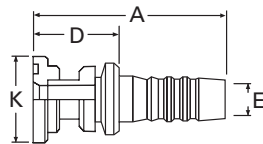

For use with hose:

Clamp: 2661 (-12 thru -20), FC619 (-12 thru -20).

Socket 1SA: 2681, FC310, FC510, FC639/FC839B (-4 thru -8), GH194 (-4 thru -20), GH663, GH681.

Socket 1SB: 2781, FC195, FC466, FC498, FC598, FC579, FC639/FC839B (-10 thru -16), FC735 (-4 thru -20), FC849/FC849B (-06 thru -12), GH120 (-4 thru -20), GH195, GH781 (-04 thru -20), GH793, 2766.

3 Global OTC fitting

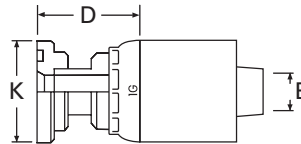

For use with hose:

2583, 2661, FC466, FC498, FC598, FC619, FC699.

4 Global TTC12 fittings

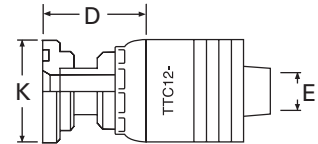

For use with hose:

FC636, FC736, GH493, EC525.

1 TTC part #	2 Nipple part #	3 OTC part #	4 TTC12 part #	Thd. Flange head Dia. K Ø	Hose size	A		D		EØ	
						mm	in	mm	in	mm	in
1A10KS10	1S10KS10	1G10KS10	1B10KS10	34.2	-10	94,2	0.16	64,8	2.55	11,5	0.45

Komatsu split flange 45° elbow (KSA)

1 Global TTC fittings

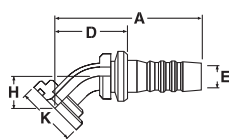

2 Global nipples

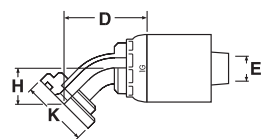

3 Global OTC fitting

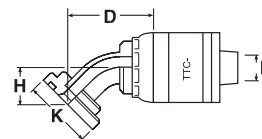

4 Global TTC12 fittings

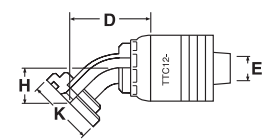

1 TTC part #	2 Nipple part #	3 OTC part #	4 TTC12 part #	Thd. Flange head Dia. K Ø	Hose size	A		D		EØ		H	
						mm	in	mm	in	mm	in		
1A10KSA10	1S10KSA10	1G10KSA10	1B10KSA10	34.2	-10	86,1	3.39	56,7	2.23	11,5	0.45	21,8	0.86

Crimp fittings

Braided, low pressure and four spiral
(TTC / 1SA / 1GA / TTC-12 Series)

H

Komatsu split flange 90° elbow (KSB)

1 Global TTC fittings

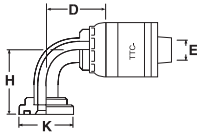

For use with hose:

2661(-12 thru -32), FC310, FC510, FC579, FC611, FC619 (-12 thru -32), FC639/FC839B, FC693, FC735, FC849/FC849B, GH120, GH194, GH195, GH663, GH681, GH781, GH793.

2 Global nipples

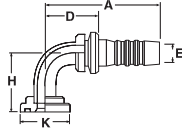

For use with hose:

Clamp: 2661 (-12 thru -20), FC619 (-12 thru -20).

Socket 1SA: 2681, FC310, FC510, FC639/FC839B (-4 thru -8), GH194 (-4 thru -20), GH663, GH681.

Socket 1SB: 2781, FC195, FC466, FC498, FC598, FC579, FC639/FC839B (-10 thru -16), FC735 (-4 thru -20), FC849/FC849B (-06 thru -12), GH120 (-4 thru -20), GH195, GH781 (-04 thru -20), GH793, 2766.

3 Global OTC fitting

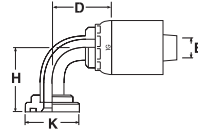

For use with hose:

2583, 2661, FC466, FC498, FC598, FC619, FC699.

4 Global TTC12 fittings

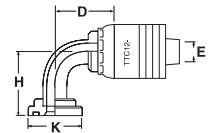

For use with hose:

FC636, FC736, GH493, EC525.

1 TTC part #	2 Nipple part #	3 OTC part #	4 TTC12 part #	Thd. Flange head Dia. K Ø	Hose size	A		D		EØ		H	
						mm	in	mm	in	mm	in	mm	in
1A10KSB10	1S10KSB10	1G10KSB10	1B10KSB10 4S10KSB10*	34.2	-10	77,9	3.07	48,5	1.91	11,5	0.45	51,3	2.02

* Part number denotes 4S equivalent fitting.

4S Fittings

For use with hose:

EC525-12,-16,-20,-24,-32;
GH493-12,-16,-20,-24,-32;
FC636-12,-16,-20,-24,-32;
FC736-12,-16,-20,-24,-32;

Male Pipe NPTF - Rigid (MP)

Straight

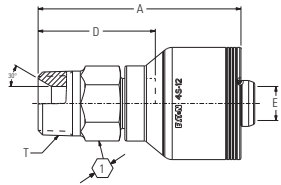

4S

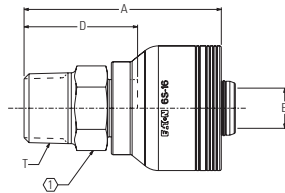

6S

FC500-12,-16,-20,-24;
FC273B-12,-16;
GH506-12,-16,-20,-24,-32;
FC254-12,-16,-20,-24,-32;
EC810-12,-16;

6S Fittings

For use with hose:

FC500-32; FC273B-20,-24,-32;
FC606-16,-20,-24;
EC810-20,-24,-32;
GH466-20,-24

# Part Number	Terminal End	Hose Size		Thread	A		D		E Ø		1
		DN	Dash size		in	mm	in	mm	in	mm	
4S	Dash size	DN	Dash size	in	mm	in	mm	in	mm	in	in
4SA8MP12	-8	19	-12	1/2-14	84,6	3.33	48,4	1.90	14,2	0.56	7/8
4SA12MP12	-12	19	-12	3/4-14	85,9	3.38	49,6	1.95	14,2	0.56	1 1/16
4SA16MP12	-16	19	-12	1-11 1/2	84,8	3.34	48,6	1.91	14,2	0.56	1 3/8
4SA12MP16	-12	25	-16	3/4-14	89,1	3.51	49,2	1.94	19,2	0.75	1 3/8
4SA16MP16	-16	25	-16	1-11 1/2	94,0	3.70	54,1	2.13	19,2	0.75	1 3/8
4SA20MP16	-20	25	-16	1 1/4-11 1/2	90,4	3.56	50,5	1.99	19,2	0.75	1 11/16
4SA16MP20	-16	31	-20	1-11 1/2	107,6	4.24	52,5	2.07	25,2	0.99	1 7/16
4SA20MP20	-20	31	-20	1 1/4-11 1/2	119,6	4.71	64,4	2.54	25,2	0.99	1 11/16
4SA24MP24	-24	38	-24	1 1/2-11 1/2	143,2	5.64	65,2	2.57	31,1	1.22	2
4SA32MP32	-32	51	-32	2-11 1/2	150,1	5.91	72,1	2.84	42,1	1.66	2 1/2
6S	Dash size	DN	Dash size	in	mm	in	mm	in	mm	in	in
6SA16MP16	-16	25	-16	1-11 1/2	94,0	3.70	54,1	2.13	19,2	0.75	1 3/8
6SA20MP20	-20	31	-20	1 1/4-11 1/2	120,4	4.74	64,4	2.54	25,2	0.99	1 11/16
6SA24MP24	-24	38	-24	1 1/2-11 1/2	143,2	5.64	65,2	2.57	31,1	1.22	2
6SA32MP32	-32	51	-32	2-11 1/2	150,1	5.91	72,1	2.84	42,1	1.66	2 1/2

Male Pipe NPTF - Swivel (PS)

Straight

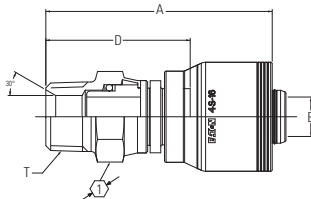

4S

# Part Number	Terminal End	Hose Size		Thread	A		D		E Ø		1
		DN	Dash size		in	mm	in	mm	in		
4S	Dash size	DN	Dash size	in	mm	in	mm	in	mm	in	in
4SA16PS16	-16	25	-16	1-11 1/2	110,2	4.34	70,1	2.76	19,2	0.75	1 1/2

Male JIC/37° - Rigid (MJ)

Straight

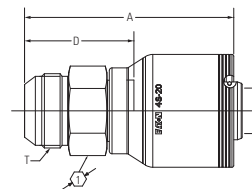

4S

# Part Number	Terminal End	Hose Size		Thread	A		D		E Ø		1
		DN	Dash size		in	mm	in	mm	in		
4S	Dash size	DN	Dash size	in	mm	in	mm	in	mm	in	in
4SA10MJ12	-10	19	-12	7/8-14	84,3	3.32	48,2	1.90	12,3	0.48	15/16
4SA12MJ12	-12	19	-12	1 1/16-12	86,9	3.42	50,8	2.00	14,2	0.56	1 1/8
4SA14MJ12	-14	19	-12	1 3/16-12	83,1	3.27	47,0	1.85	14,2	0.56	1 1/4
4SA16MJ12	-16	19	-12	1 5/16-12	83,6	3.29	47,5	1.87	14,2	0.56	1 3/8
4SA16MJ16	-16	25	-16	1 5/16-12	93,7	3.69	54,0	2.13	19,2	0.75	1 3/8
4SA20MJ16	-20	25	-16	1 5/8-12	99,6	3.92	60,0	2.36	19,2	0.76	1 11/16
4SA20MJ20	-20	31	-20	1 5/8-12	115,7	4.56	60,5	2.38	25,2	0.99	1 11/16
4SA24MJ24	-24	38	-24	1 7/8-12	151,3	5.96	73,3	2.89	31,1	1.22	2
4SA32MJ32	-32	51	-32	2 1/2-12	163,8	6.45	85,8	3.38	42,1	1.66	2 5/8

⚠ Refer to note below.

⚠ When assembled with all Eaton components, all SAE 37° JIC male and female terminal ends in the 4S & 6S product line are rated at the pressures listed in the table above and have passed one million impulse cycles at 133% of this pressure. All straight configurations achieve a 4:1 burst.

The 45° and 90° elbow configurations in the -12 size meet a 3.2:1 burst the 45° and 90° elbow configurations in the -16 size achieve a 2.8:1 burst; the 45° and 90° elbow configurations in the -20 size meet a 4:1 burst and the 45° & 90° elbow configurations in the -24 size meet a 2.4:1 burst.

Crimp fittings

Spiral hose fittings (4S/6S Series)

4S Fittings

For use with hose:

EC525-12,-16,-20,-24,-32;
GH493-12,-16,-20,-24,-32;
FC636-12,-16,-20,-24,-32;
FC736-12,-16,-20,-24,-32;
FC500-12,-16,-20,-24;

FC273B-12,-16;
GH506-12,-16,-20,-24,-32;
FC254-12,-16,-20,-24,-32;
EC810 -12,-16;

6S Fittings

For use with hose:

FC500-32;
FC273B-20,-24,-32;
FC606-16,-20,-24;
EC810-20,-24,-32;
GH466-20,-24

Female JIC/37° swivel (FJ)

Straight

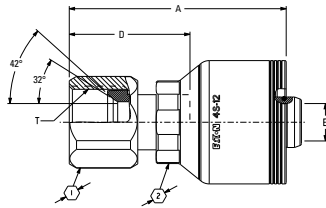

4S

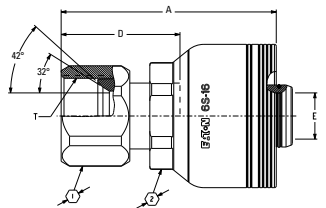

6S

# Part Number	Terminal End	Hose Size		Thread	A		D		E Ø		1		2
		DN	Dash size		in	mm	in	mm	in	mm	in	mm	
4SA10FJ12	-10	19	-12	7/8-14	75,0	2.95	38,8	1.53	12,3	0.48	30,0	1 3/16	1
4SA12FJ12	-12	19	-12	1 1/16-12	82,0	3.23	45,7	1.80	14,2	0.56	30,0	1 3/16	1 1/4
4SA14FJ12	-14	19	-12	1 3/16-12	77,5	3.05	41,3	1.63	14,2	0.56	30,0	1 3/16	1 3/8
4SA16FJ12	-16	19	-12	1 5/16-12	80,2	3.16	44,0	1.73	14,2	0.56	30,0	1 3/16	1 1/2
4SA12FJ16	-12	25	-16	1 1/16-12	78,8	3.10	39,1	1.54	15,5	0.61	41,0	1 5/8	1 1/4
4SA16FJ16	-16	25	-16	1 5/16-12	89,2	3.51	49,3	1.94	19,2	0.76	41,0	1 5/8	1 1/2
4SA20FJ16	-20	25	-16	1 5/8-12	85,8	3.38	46,0	1.81	19,2	0.76	41,0	1 5/8	2
4SA16FJ20	-16	31	-20	1 5/16-12	99,1	3.90	43,7	1.72	25,2	0.99	46,0	1 13/16	1 1/2
4SA20FJ20	-20	31	-20	1 5/8-12	101,6	4.00	46,3	1.82	25,2	0.99	46,0	1 13/16	2
4SA24FJ20	-24	31	-20	1 7/8-12	106,8	4.20	51,5	2.03	25,2	0.99	46,0	1 13/16	2 1/4
4SA24FJ24	-24	38	-24	1 7/8-12	134,9	5.31	56,8	2.24	31,1	1.22	57,0	2 1/4	2 1/4
4SA32FJ32	-32	51	-32	2 1/2-12	146,0	5.75	68,0	2.68	42,1	1.66			2 7/8
6S	Dash size	DN	Dash size	in	mm	in	mm	in	mm	in	mm	in	in
6SA16FJ16	-16	25	-16	1 5/16-12	89,2	3.51	49,3	1.94	19,2	0.76	41,0	1 5/8	1 1/2
6SA20FJ20	-20	31	-20	1 5/8-12	102,3	4.03	46,3	1.82	25,2	0.99	46,0	1 13/16	2
6SA24FJ20	-24	31	-20	1 7/8-12	107,5	4.23	51,5	2.03	25,2	0.99	46,0	1 13/16	2 1/4
6SA24FJ24	-24	38	-24	1 7/8-12	134,9	5.31	56,8	2.24	31,1	1.22	57,0	2 1/4	2 1/4
6SA32FJ32	-32	51	-32	2 1/2-12	146,0	5.75	68,0	2.68	42,1	1.66			2 7/8

⚠ Refer to note below.

Female JIC/37° swivel (FJA)

45° Elbow

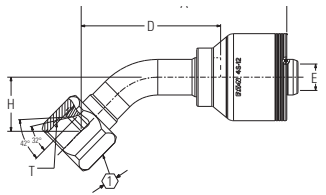

4S

# Part Number	Terminal End	Hose Size		Thread	A		D		E Ø		H		1
		DN	Dash size		in	mm	in	mm	in	mm	in	mm	
4SA12FJA12	-12	19	-12	1 1/16-12	112,3	4.42	76,1	3.00	14,2	0.56	29,0	1.14	1 1/4
4SA16FJA12	-16	19	-12	1 5/16-12	133,6	5.26	97,5	3.84	14,2	0.56	38,0	1.50	1 1/2
4SA16FJA16	-16	25	-16	1 5/16-12	128,8	5.07	89,3	3.52	19,2	0.76	38,0	1.50	1 1/2
4SA20FJA16	-20	25	-16	1 5/8-12	120,1	4.73	80,4	3.17	19,2	0.75	32,0	1.26	2
4SA20FJA20	-20	31	-20	1 5/8-12	135,6	5.34	80,4	3.17	25,2	0.99	32,0	1.26	2
4SA24FJA24	-24	38	-24	1 7/8-12	212,0	8.35	134,0	5.28	31,1	1.22	43,0	1.69	2 1/4
6S	Dash size	DN	Dash size	in	mm	in	mm	in	mm	in	mm	in	in
6SA20FJA20	-20	31	-20	1 5/8-12	136,4	5.37	80,4	3.17	25,2	0.99	32,0	1.26	2
6SA24FJA24	-24	38	-24	1 7/8-12	212,0	8.35	134,0	5.28	31,1	1.22	43,0	1.69	2 1/4

⚠ Refer to note below.

⚠ When assembled with all Eaton components, all SAE 37° JIC male and female terminal ends in the 4S & 6S product line are rated at the pressures listed in the table above and have passed one million impulse cycles at 133% of this pressure. All straight configurations achieve a 4:1 burst.

The 45° and 90° elbow configurations in the -12 size meet a 3.2:1 burst the 45° and 90° elbow configurations in the -16 size achieve a 2.8:1 burst; the 45° and 90° elbow configurations in the -20 size meet a 4:1 burst and the 45° & 90° elbow configurations in the -24 size meet a 2.4:1 burst.

4S Fittings

For use with hose:

EC525-12,-16,-20,-24,-32;
GH493-12,-16,-20,-24,-32;
FC636-12,-16,-20,-24,-32;
FC736-12,-16,-20,-24,-32;

Female JIC/37° swivel (FJG)

60° Elbow

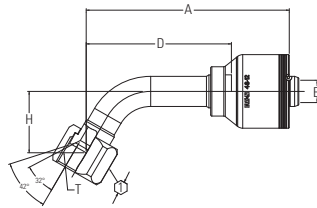

4S

Female JIC/37° swivel (FJB)

90° Elbow

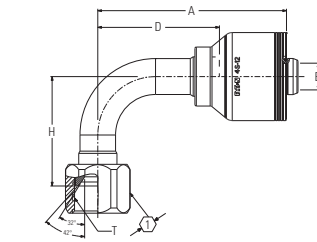

4S

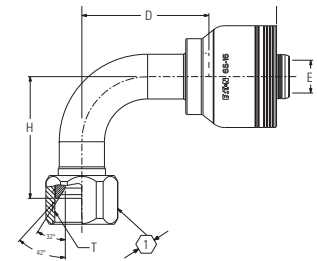

6S

Female JIC/37° swivel (FJC)

90° Elbow - Long Drop

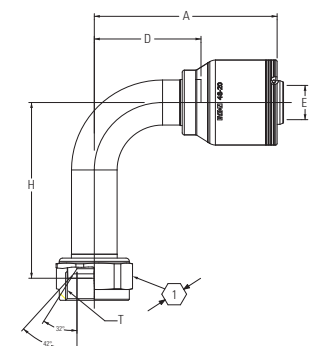

4S

6S Fittings

For use with hose:

FC500-32;FC273B-20,-24,-32;
FC606-16,-20,-24;
EC810-20,-24,-32; GH466-
20,-24

# Part Number	Terminal End	Hose Size		Thread	A		D		E Ø		H		1
		DN	Dash size		in	mm	in	mm	in	mm	in	mm	
4SA12FJG12	-12	19	-12	1 1/16-12	127,0	5.00	90,8	3.58	14,2	0.56	38,9	1.53	1 1/4
4SA16FJG16	-16	25	-16	1 5/16-12	144,4	5.69	104,8	4.12	19,2	0.76	47,6	1.87	1 1/2

⚠ Refer to note below.

# Part Number	Terminal End	Hose Size		Thread	A		D		E Ø		H		1
		DN	Dash size		in	mm	in	mm	in	mm	in	mm	
4SA12FJB12	-12	19	-12	1 1/16-12	101,3	3.99	65,3	2.57	14,2	0.56	58,0	2.28	1 1/4
4SA16FJB12	-16	19	-12	1 5/16-12	110,0	4.33	73,8	2.91	14,2	0.56	71,0	2.80	1 1/2
4SA16FJB16	-16	25	-16	1 5/16-12	113,1	4.45	73,5	2.89	19,2	0.76	71,0	2.80	1 1/2
4SA20FJB16	-20	25	-16	1 5/8-12	117,1	4.61	77,4	3.05	19,2	0.75	78,0	3.07	2
4SA20FJB20	-20	31	-20	1 5/8-12	132,6	5.22	77,4	3.05	25,2	0.99	78,0	3.07	2
4SA24FJB24	-24	38	-24	1 7/8-12	208,9	8.22	130,8	5.15	31,1	1.22	104,0	4.09	2 1/4
6S	Dash size	DN	Dash size	in	mm	in	mm	in	mm	in	mm	in	in
6SA16FJB16	-16	25	-16	1 5/16-12	113,1	4.45	73,5	2.89	19,0	0.75	71,0	2.80	1 1/2
6SA20FJB20	-20	31	-20	1 5/8-12	133,4	5.25	77,4	3.05	25,2	0.99	78,0	3.07	2
6SA24FJB24	-24	38	-24	1 7/8-12	208,9	8.22	130,8	5.15	31,1	1.22	104,0	4.09	2 1/4

⚠ Refer to note below.

# Part Number	Terminal End	Hose Size		Thread	A		D		E Ø		H		1
		DN	Dash size		in	mm	in	mm	in	mm	in	mm	
4SA12FJC12	-12	19	-12	1 1/16-12	101,3	3.99	65,3	2.57	14,2	0.56	96,0	3.78	1 1/4
4SA16FJC16	-16	25	-16	1 5/16-12	112,5	4.43	73,5	2.89	19,0	0.75	114,0	4.49	1 1/2
4SA20FJC20	-20	31	-20	1 5/8-12	132,6	5.22	77,4	3.05	25,2	0.99	129,0	5.08	2

⚠ Refer to note below.

⚠ When assembled with all Eaton components, all SAE 37° JIC male and female terminal ends in the 4S & 6S product line are rated at the pressures listed in the table above and have passed one million impulse cycles at 133% of this pressure. All straight configurations achieve a 4:1 burst.

The 45° and 90° elbow configurations in the -12 size meet a 3.2:1 burst the 45° and 90° elbow configurations in the -16 size achieve a 2.8:1 burst; the 45° and 90° elbow configurations in the -20 size meet a 4:1 burst and the 45° & 90° elbow configurations in the -24 size meet a 2.4:1 burst.

Crimp fittings

Spiral hose fittings (4S/6S Series)

H

4S Fittings

For use with hose:

EC525-12,-16,-20,-24,-32;
GH493-12,-16,-20,-24,-32;
FC636-12,-16,-20,-24,-32;
FC736-12,-16,-20,-24,-32;

6S Fittings

For use with hose:

FC500-32;
FC273B-20,-24,-32;
FC606-16,-20,-24;
EC810-20,-24,-32;
GH466-20,-24

Male Oring boss - Rigid (MB)

Straight

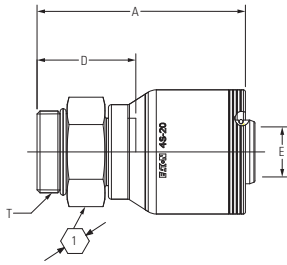

4S

# Part Number	Terminal End	Hose Size		Thread	A		D		E Ø		1
		DN	Dash size		in	mm	in	mm	in	mm	
4SA12MB12	-12	19	-12	1 1/16-12	78,7	3.10	42,5	1.67	14,2	0.56	1 1/4
4SA16MB16	-16	25	-16	1 5/16-12	88,1	3.47	48,5	1.91	19,2	0.76	1 1/2
4SA20MB20	-20	31	-20	1 5/8-12	109,5	4.31	54,4	2.14	25,2	0.99	1 7/8
4SA24MB24	-24	38	-24	1 7/8-12	134,1	5.28	56,0	2.21	31,1	1.22	2 1/8

Female SAE 45° Flare swivel (FS)

Straight

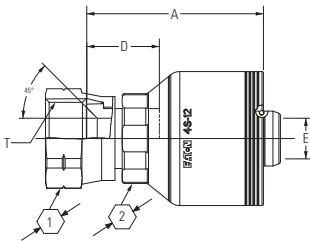

4S

# Part Number	Terminal End	Hose Size		Thread	A		D		E Ø		1	2
		DN	Dash size		in	mm	in	mm	in	mm		
4SA12FS12	-12	19	-12	1 1/16-14	61,5	2.42	25,4	1.00	14,2	0.56	1 1/4	1 3/16

Male ORS - Rigid (MR)

Straight

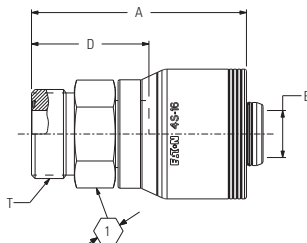

4S

# Part Number	Terminal End	Hose Size		Thread	A		D		E Ø		1
		DN	Dash size		in	mm	in	mm	in	mm	
4SA12MR12	-12	19	-12	1 3/16-12	80,8	3.18	44,4	1.75	14,2	0.56	1 1/4
4SA16MR12	-16	19	-12	1 7/16-12	78,2	3.08	41,9	1.65	14,2	0.56	1 1/2
4SA16MR16	-16	25	-16	1 7/16-12	87,7	3.45	47,9	1.89	19,2	0.76	1 1/2
4SA20MR16	-20	25	-16	1 11/16-12	81,1	3.19	41,5	1.63	19,2	0.76	1 3/4
4SA20MR20	-20	31	-20	1 11/16-12	107,1	4.22	52,0	2.05	25,2	0.99	1 3/4

4S Fittings

For use with hose:

EC525-12,-16,-20,-24,-32;
GH493-12,-16,-20,-24,-32;
FC636-12,-16,-20,-24,-32;
FC736-12,-16,-20,-24,-32;
FC500-12,-16,-20,-24;

FC273B-12,-16;
GH506-12,-16,-20,-24,-32;
FC254-12,-16,-20,-24,-32;
EC810-12,-16;

6S Fittings

For use with hose:

FC500-32;
FC273B-20,-24,-32;
FC606-16,-20,-24;
EC810-20,-24,-32;
GH466-20,-24

Female ORS swivel (FR)

Straight

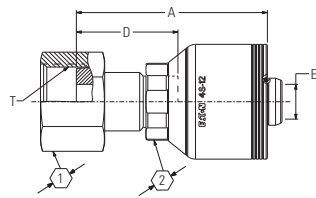

4S

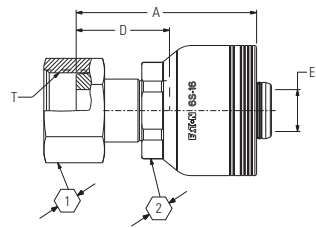

6S

# Part Number	Terminal End	Hose Size		Thread	A		D		E Ø		1		2
		DN	Dash size		in	mm	in	mm	in	mm	in	mm	in
4SA10FR12	-10	19	-12	1 - 14	74,4	2.93	38,1	1.50	14,2	0.56	30,0	1 3/16	1 1/8
4SA12FR12	-12	19	-12	1 3/16-12	77,4	3.05	41,2	1.62	14,2	0.56	30,0	1 3/16	1 3/8
4SA16FR12	-16	19	-12	1 7/16-12	79,2	3.12	43,1	1.70	14,2	0.56	30,0	1 3/16	1 5/8
4SA12FR16	-12	25	-16	1 3/16-12	80,5	3.17	40,8	1.61	19,2	0.76	41,0	1 5/8	1 3/8
4SA16FR16	-16	25	-16	1 7/16-12	82,4	3.24	42,6	1.68	19,2	0.76	41,0	1 5/8	1 5/8
4SA20FR16	-20	25	-16	1 11/16-12	82,4	3.24	42,7	1.68	19,2	0.76	41,0	1 5/8	1 7/8
4SA20FR20	-20	31	-20	1 11/16-12	99,0	3.90	43,8	1.72	25,2	0.99	46,0	1 13/16	1 7/8
4SA24FR24	-24	38	-24	2 - 12	125,7	4.95	47,6	1.87	31,1	1.22	57,0	2 1/4	2 1/4
6S	Dash size	DN	Dash size	in	mm	in	mm	in	mm	in	mm	in	in
6SA16FR16	-16	25	-16	1 7/16-12	82,4	3.24	42,6	1.68	19,2	0.76	41,0	1 5/8	1 5/8
6SA20FR16	-20	25	-16	1 11/16-12	82,4	3.24	42,7	1.68	19,2	0.76	41,0	1 5/8	1 7/8
6SA20FR20	-20	31	-20	1 11/16-12	99,8	3.93	43,8	1.72	25,2	0.99	46,0	1 13/16	1 7/8
6SA24FR24	-24	38	-24	2 - 12	125,7	4.95	47,6	1.87	31,1	1.22	57,0	2 1/4	2 1/4

Female ORS swivel (FRA)

45° Elbow

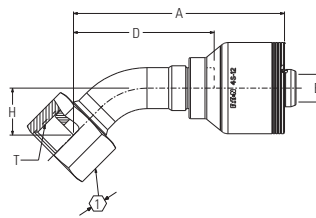

4S

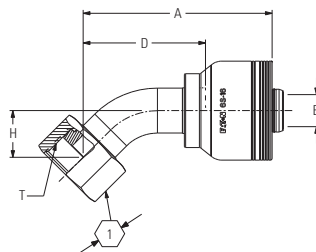

6S

# Part Number	Terminal End	Hose Size		Thread	A		D		E Ø		H		1
		DN	Dash size		in	mm	in	mm	in	mm	in	mm	in
4SA12FRA12	-12	19	-12	1 3/16-12	108,7	4.28	72,5	2.85	14,2	0.56	24,0	0.94	1 3/8
4SA16FRA12	-16	19	-12	1 7/16-12	119,9	4.72	83,7	3.30	14,2	0.56	28,0	1.10	1 5/8
4SA16FRA16	-16	25	-16	1 7/16-12	112,8	4.44	73,0	2.87	19,2	0.76	28,0	1.10	1 5/8
4SA20FRA16	-20	25	-16	1 11/16-12	136,7	5.38	97,0	3.82	19,2	0.76	31,0	1.22	1 7/8
4SA20FRA20	-20	31	-20	1 11/16-12	153,4	6.04	98,1	3.86	25,2	0.99	31,0	1.22	1 7/8
4SA24FRA24	-24	38	-24	2 - 12	212,0	8.35	134,0	5.28	31,1	1.22	43,0	1.69	2 1/4
6S	Dash size	DN	Dash size	in	mm	in	mm	in	mm	in	mm	in	in
6SA16FRA16	-16	25	-16	1 7/16-12	112,8	4.44	73,0	2.87	19,2	0.76	28,0	1.10	1 5/8
6SA20FRA16	-20	25	-16	1 11/16-12	136,7	5.38	97,0	3.82	19,2	0.76	31,0	1.22	1 7/8
6SA20FRA20	-20	31	-20	1 11/16-12	154,1	6.07	98,1	3.86	25,2	0.99	31,0	1.22	1 7/8
6SA24FRA24	-24	38	-24	2 - 12	212,0	8.35	134,0	5.28	31,1	1.22	43,0	1.69	2 1/4

Crimp fittings

Spiral hose fittings (4S/6S Series)

H

4S Fittings

For use with hose:

EC525-12,-16,-20,-24,-32;
GH493-12,-16,-20,-24,-32;
FC636-12,-16,-20,-24,-32;
FC736-12,-16,-20,-24,-32;

FC500-12,-16,-20,-24;
FC273B-12,-16;
GH506-12,-16,-20,-24,-32;
FC254-12,-16,-20,-24,-32;
EC810-12,-16;

6S Fittings

For use with hose:

FC500-32;
FC273B-20,-24,-32;
FC606-16,-20,-24;
EC810-20,-24,-32;
GH466-20,-24

Female ORS swivel (FRB)

90° Elbow

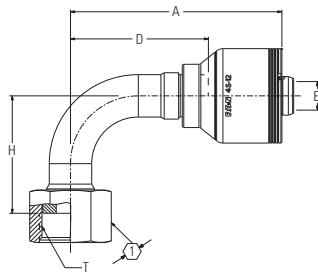

4S

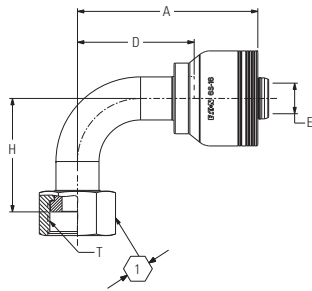

6S

# Part Number	Terminal End	Hose Size		Thread	A		D		E Ø		H		1
		DN	Dash size		in	mm	in	mm	in	mm	in	mm	
4S	Dash size	DN	Dash size	in	mm	in	mm	in	mm	in	mm	in	in
4SA10FRB12	-10	19	-12	1 - 14	91,5	3.60	55,3	2.18	14,2	0.56	32,3	1.27	1 1/8
4SA12FRB12	-12	19	-12	1 3/16-12	104,4	4.11	68,1	2.68	14,2	0.56	58,0	2.28	1 3/8
4SA16FRB12	-16	19	-12	1 7/16-12	117,1	4.61	80,9	3.19	14,2	0.56	71,0	2.80	1 5/8
4SA12FRB16	-12	25	-16	1 3/16-12	107,5	4.23	67,7	2.67	19,2	0.76	58,0	2.28	1 3/8
4SA16FRB16	-16	25	-16	1 7/16-12	112,8	4.44	73,0	2.87	19,2	0.76	71,0	2.80	1 5/8
4SA20FRB16	-20	25	-16	1 11/16-12	136,5	5.37	96,8	3.81	19,2	0.76	78,0	3.07	1 7/8
4SA20FRB20	-20	31	-20	1 11/16-12	153,1	6.03	97,9	3.85	25,2	0.99	78,0	3.07	1 7/8
4SA24FRB20	-24	31	-20	2 - 12	152,9	6.02	97,9	3.85	25,2	0.99	86,0	3.39	2 1/4
4SA24FRB24	-24	38	-24	2 - 12	208,9	8.22	130,8	5.15	31,1	1.22	104,0	4.09	2 1/4
6S	Dash size	DN	Dash size	in	mm	in	mm	in	mm	in	mm	in	in
6SA16FRB16	-16	25	-16	1 7/16-12	112,8	4.44	73,0	2.87	19,2	0.76	71,0	2.80	1 5/8
6SA20FRB16	-20	25	-16	1 11/16-12	136,5	5.37	96,8	3.81	19,2	0.76	78,0	3.07	1 7/8
6SA20FRB20	-20	31	-20	1 11/16-12	153,9	6.06	97,9	3.85	25,2	0.99	78,0	3.07	1 7/8
6SA24FRB24	-24	38	-24	2 - 12	208,9	8.22	130,8	5.15	31,1	1.22	104,0	4.09	2 1/4

Female ORS swivel (FRC)

90° Elbow - Long Drop

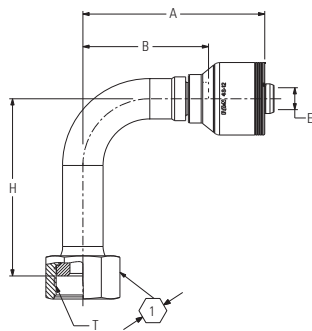

4S

# Part Number	Terminal End	Hose Size		Thread	A		D		E Ø		H		1
		DN	Dash size		in	mm	in	mm	in	mm	in	mm	
4S	Dash size	DN	Dash size	in	mm	in	mm	in	mm	in	mm	in	in
4SA10FRC12	-10	19	-12	1 - 14	91,5	3.60	55,3	2.18	14,2	0.56	70,0	2.76	1 1/8
4SA12FRC12	-12	19	-12	1 3/16-12	104,4	4.11	68,1	2.68	14,2	0.56	96,0	3.78	1 3/8
4SA16FRC12	-16	19	-12	1 7/16-12	117,1	4.61	80,9	3.19	14,2	0.56	114,0	4.49	1 5/8
4SA16FRC16	-16	25	-16	1 7/16-12	112,8	4.44	73,0	2.87	19,2	0.76	114,0	4.49	1 5/8
4SA20FRC20	-20	31	-20	1 11/16-12	152,9	6.02	97,9	3.85	25,2	0.99	129,0	5.08	1 7/8
4SA24FRC20	-24	31	-20	2 - 12	152,9	6.02	97,9	3.85	25,2	0.99	141,0	5.55	2 1/4
4SA24FRC24	-24	38	-24	2 - 12	152,9	6.02	97,9	3.85	25,2	0.99	141,0	5.55	2 1/4

4S Fittings

For use with hose:

EC525-12,-16,-20,-24,-32;
GH493-12,-16,-20,-24,-32;
FC636-12,-16,-20,-24,-32;
FC736-12,-16,-20,-24,-32;

FC500-12,-16,-20,-24;
FC273B-12,-16;
GH506-12,-16,-20,-24,-32;
FC254-12,-16,-20,-24,-32;
EC810-12,-16;

6S Fittings

For use with hose:

FC500-32;
FC273B-20,-24,-32;
FC606-16,-20,-24;
EC810-20,-24,-32;
GH466-20,-24

SAE Code 61 Flange (FL)

Straight

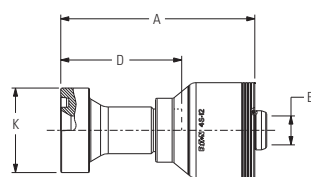

4S

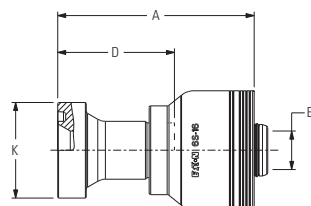

6S

# Part Number	Terminal End	Hose Size		Flange Head Dia. K Ø		A		D		E Ø	
		DN	Dash size	mm	in	mm	in	mm	in	mm	in
4S12FL12	-12	19	-12	38,1	1.50	90,7	3.57	54,5	2.15	14,2	0.56
4S16FL12	-16	19	-12	44,5	1.75	90,2	3.55	54,0	2.13	14,2	0.56
4S20FL12	-20	19	-12	50,8	2.00	97,7	3.85	61,5	2.42	14,2	0.56
4S16FL16	-16	25	-16	44,5	1.75	93,3	3.67	53,6	2.11	19,2	0.76
4S20FL16	-20	25	-16	50,8	2.00	100,8	3.97	61,1	2.41	19,2	0.76
4S24FL16	-24	25	-16	60,4	2.38	97,4	3.83	57,7	2.27	19,2	0.76
4S16FL20	-16	31	-20	44,5	1.75	110,5	4.35	55,5	2.18	25,2	0.99
4S20FL20	-20	31	-20	50,8	2.00	117,4	4.62	62,2	2.45	25,2	0.99
4S24FL20	-24	31	-20	60,4	2.38	106,7	4.20	51,6	2.03	25,2	0.99
4S32FL20	-32	31	-20	71,4	2.81	104,9	4.13	49,9	1.96	25,2	0.99
4S24FL24	-24	38	-24	60,4	2.38	171,6	6.75	93,6	3.68	31,1	1.22
4S32FL24	-32	38	-24	71,4	2.81	174,7	6.88	96,7	3.81	31,1	1.22
4S32FL32	-32	51	-32	71,4	2.81	177,5	6.99	99,5	3.92	42,1	1.66
6S	Dash size	DN	Dash size	mm	in	mm	in	mm	in	mm	in
6S16FL16	-16	25	-16	44,5	1.75	93,3	3.67	53,6	2.11	19,2	0.76
6S20FL20	-20	31	-20	50,8	2.00	118,2	4.65	62,2	2.45	25,2	0.99
6S24FL24	-24	38	-24	60,4	2.38	171,6	6.75	93,6	3.68	31,1	1.22
6S32FL24	-32	38	-24	71,4	2.81	174,7	6.88	96,7	3.81	31,1	1.22
6S32FL32	-32	51	-32	71,4	2.81	177,5	6.99	99,5	3.92	42,1	1.66

SAE Code 61 Flange (FLD)

22.5° Elbow

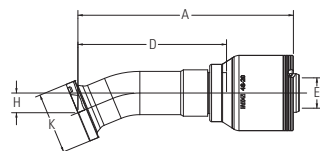

4S

# Part Number	Terminal End	Hose Size		Flange Head Dia. K Ø		A		D		E Ø		H	
		DN	Dash size	mm	in	mm	in	mm	in	mm	in	mm	in
4S12FLD12	-12	19	-12	38,1	1.50	121,3	4.78	85,1	3.35	14,2	0.56	11,6	0.46
4S16FLD12	-16	25	-12	44,4	1.75	136,7	5.38	100,5	3.96	14,2	0.56	13,5	0.53
4S16FLD16	-16	25	-16	44,4	1.75	139,8	5.50	100,1	3.94	19,2	0.76	13,5	0.53
4S20FLD16	-20	25	-16	50,8	2.00	160,9	6.33	121,2	4.77	19,2	0.76	16,3	0.64
4S20FLD20	-20	31	-20	50,8	2.00	177,3	6.98	122,3	4.81	25,2	0.99	16,3	0.64
4S24FLD20	-24	31	-20	60,4	2.38	173,6	6.83	117,6	4.63	25,2	0.99	17,1	0.67
4S24FLD24	-24	38	-24	60,3	2.37	226,4	8.91	148,4	5.84	31,1	1.22	18,8	0.74
4S32FLD24	-32	38	-24	71,4	2.81	266,7	10.50	188,7	7.43	31,1	1.22	23,5	0.93
4S32FLD32	-32	51	-32	71,4	2.81	269,6	10.61	191,5	7.54	42,1	1.66	23,5	0.93

Crimp fittings

Spiral hose fittings
(4S/6S Series)

H

4S Fittings

For use with hose:

EC525-12,-16,-20,-24,-32;
GH493-12,-16,-20,-24,-32;
FC636-12,-16,-20,-24,-32;
FC736-12,-16,-20,-24,-32;

6S Fittings

For use with hose:

FC500-32;
FC273B-20,-24,-32;
FC606-16,-20,-24;
EC810-20,-24,-32;
GH466-20,-24

SAE Code 61 Flange (FLF)

30° Elbow

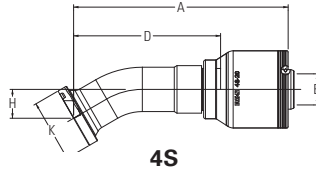

4S

# Part Number	Terminal End	Hose Size		Flange Head Dia. K Ø		A		D		E Ø		H	
		Dash size	DN	Dash size	mm	in	mm	in	mm	in	mm	in	mm
4S12FLF12	-12	19	-12	38,1	1.50	119,4	4.70	83,3	3.28	14,2	0.56	16,4	0.65
4S16FLF12	-16	19	-12	44,4	1.75	134,6	5.30	98,4	3.87	14,2	0.56	19,3	0.76
4S16FLF16	-16	25	-16	44,4	1.75	137,7	5.42	97,9	3.85	19,2	0.76	19,3	0.76
4S20FLF16	-20	25	-16	50,8	2.00	158,3	6.23	118,6	4.67	19,2	0.76	23,3	0.92
4S20FLF20	-20	31	-20	50,8	2.00	174,7	6.88	119,7	4.71	25,2	0.99	23,3	0.92
4S24FLF20	-24	31	-20	60,4	2.38	169,9	6.69	114,9	4.52	25,2	0.99	24,1	0.95
4S24FLF24	-24	38	-24	60,3	2.37	223,4	8.80	145,4	5.72	31,1	1.22	26,8	1.06
4S32FLF32	-32	51	-32	71,4	2.81	265,9	10.47	187,8	7.39	42,1	1.66	33,9	1.34

SAE Code 61 Flange (FLA)

45° Elbow

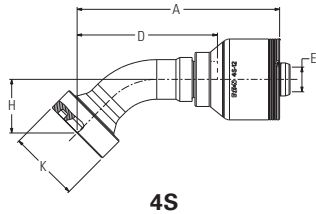

4S

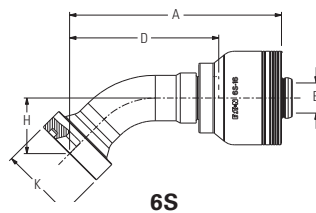

6S

# Part Number	Terminal End	Hose Size		Flange Head Dia. K Ø		A		D		E Ø		H	
		Dash size	DN	Dash size	mm	in	mm	in	mm	in	mm	in	mm
4S12FLA12	-12	19	-12	38,1	1.50	113,8	4.48	77,6	3.06	14,2	0.56	27,0	1.06
4S16FLA12	-16	19	-12	44,4	1.75	127,9	5.04	91,7	3.61	14,2	0.56	32,0	1.26
4S12FLA16	-12	25	-16	38,1	1.50	116,9	4.60	77,2	3.04	19,2	0.76	27,0	1.06
4S16FLA16	-16	25	-16	44,4	1.75	131,0	5.16	91,3	3.59	19,2	0.76	32,0	1.26
4S20FLA16	-20	25	-16	50,8	2.00	150,2	5.91	110,5	4.35	19,2	0.76	39,0	1.54
4S16FLA20	-16	31	-20	44,4	1.75	152,1	5.99	97,0	3.82	25,2	0.99	32,0	1.26
4S20FLA20	-20	31	-20	50,8	2.00	166,8	6.57	111,6	4.39	25,2	0.99	39,0	1.54
4S24FLA20	-24	31	-20	60,4	2.38	161,6	6.36	106,6	4.20	25,2	0.99	39,5	1.56
4S24FLA24	-24	38	-24	60,3	2.37	214,3	8.44	136,3	5.37	31,1	1.22	45,0	1.77
4S32FLA24	-32	38	-24	71,4	2.81	251,0	9.88	173,0	6.81	31,1	1.22	57,5	2.26
4S32FLA32	-32	51	-32	71,4	2.81	253,9	10.00	175,9	6.92	42,1	1.66	57,5	2.26
6S	Dash size	DN	Dash size	mm	in	mm	in	mm	in	mm	in	mm	in
6S16FLA16	-16	25	-16	44,4	1.75	131,0	5.16	91,3	3.59	19,2	0.76	32,0	1.26
6S20FLA16	-20	25	-16	50,8	2.00	150,2	5.91	110,5	4.35	19,2	0.76	39,0	1.54
6S20FLA20	-20	31	-20	50,8	2.00	167,6	6.60	111,6	4.39	25,2	0.99	39,0	1.54
6S24FLA24	-24	38	-24	60,3	2.37	214,3	8.44	136,3	5.37	31,1	1.22	45,0	1.77
6S32FLA24	-32	38	-24	71,4	2.81	251,0	9.88	173,0	6.81	31,1	1.22	57,5	2.26
6S32FLA32	-32	51	-32	71,4	2.81	253,9	10.00	175,9	6.92	42,1	1.66	57,5	2.26

SAE Code 61 Flange (FLG)

60° Elbow

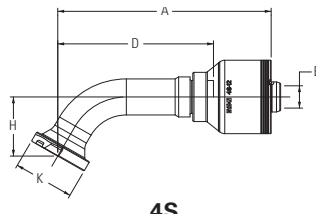

4S

# Part Number	Terminal End	Hose Size		Flange Head Dia. K Ø		A		D		E Ø		H	
		Dash size	DN	Dash size	mm	in	mm	in	mm	in	mm	in	mm
4S12FLG12	-12	19	-12	38,1	1.50	133,9	5.27	97,7	3.85	14,2	0.56	37,6	1.48
4S16FLG12	-16	19	-12	44,4	1.75	153,2	6.03	117,1	4.61	14,2	0.56	44,7	1.76
4S16FLG16	-16	25	-16	44,4	1.75	156,4	6.16	116,6	4.59	19,2	0.76	44,7	1.76
4S20FLG16	-20	25	-16	50,8	2.00	183,3	7.22	143,5	5.65	19,2	0.76	55,8	2.20
4S20FLG20	-20	25	-20	50,8	2.00	199,7	7.86	144,7	5.70	25,2	0.99	55,8	2.20
4S24FLG20	-24	31	-20	60,4	2.38	188,1	7.41	133,0	5.24	25,2	0.99	51,7	2.04
4S24FLG24	-24	38	-24	60,3	2.37	253,3	9.97	175,3	6.90	31,1	1.22	65,2	2.57
4S32FLG32	-32	51	-32	71,4	2.81	309,1	12.17	231,1	9.10	42,1	1.66	85,8	3.38

4S Fittings

For use with hose:

EC525-12,-16,-20,-24,-32;
GH493-12,-16,-20,-24,-32;
FC636-12,-16,-20,-24,-32;
FC736-12,-16,-20,-24,-32;

FC500-12,-16,-20,-24;
FC273B-12,-16;
GH506-12,-16,-20,-24,-32;
FC254-12,-16,-20,-24,-32;
EC810-12,-16;

6S Fittings

For use with hose:

FC500-32;
FC273B-20,-24,-32;
FC606-16,-20,-24;
EC810-20,-24,-32;
GH466-20,-2

SAE Code 61 Flange (FLE)

67.5° Elbow

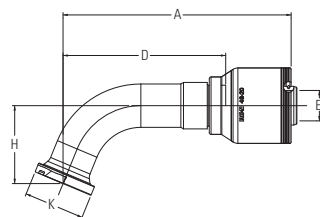

4S

# Part Number	Terminal End	Hose Size		Flange Head Dia. K Ø		A		D		E Ø		H	
		DN	Dash size	mm	in	mm	in	mm	in	mm	in	mm	in
4S12FLE12	-12	19	-12	38,1	1.50	128,6	5.06	92,4	3.64	14,2	0.56	43,2	1.70
4S16FLE12	-16	19	-12	44,4	1.75	147,0	5.79	110,8	4.36	14,2	0.56	51,5	2.03
4S16FLE16	-16	25	-16	44,4	1.75	150,1	5.91	110,3	4.34	19,2	0.76	51,5	2.03
4S20FLE16	-20	25	-16	50,8	2.00	175,4	6.91	135,7	5.34	19,2	0.76	64,4	2.54
4S20FLE20	-20	31	-20	50,8	2.00	191,8	7.55	136,8	5.39	25,2	0.99	64,4	2.54
4S24FLE20	-24	31	-20	60,4	2.38	180,8	7.12	125,8	4.95	25,2	0.99	59,5	2.34
4S24FLE24	-24	38	-24	60,3	2.37	244,2	9.61	166,2	6.54	31,1	1.22	75,2	2.96
4S32FLE24	-32	38	-24	71,4	2.81	294,1	11.58	216,1	8.51	31,1	1.22	99,3	3.91
4S32FLE32	-32	51	-32	71,4	2.81	297,0	11.69	219,0	8.62	42,1	1.66	99,3	3.91

SAE Code 61 Flange (FLB)

90° Elbow

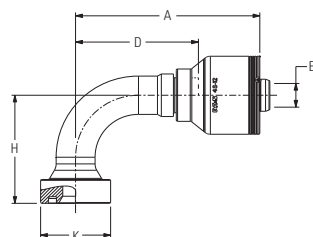

4S

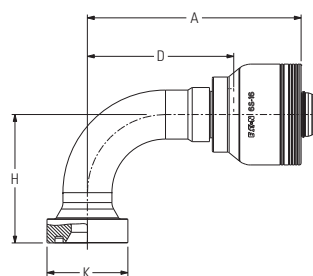

6S

# Part Number	Terminal End	Hose Size		Flange Head Dia. K Ø		A		D		E Ø		H	
		DN	Dash size	mm	in	mm	in	mm	in	mm	in	mm	in
4S12FLB12	-12	19	-12	38,1	1.50	108,5	4.27	72,3	2.85	14,2	0.56	59,0	2.32
4S16FLB12	-16	19	-12	44,4	1.75	122,8	4.84	86,6	3.41	14,2	0.56	71,0	2.80
4S20FLB12	-20	19	-12	50,8	2.00	108,5	4.72	72,3	2.85	14,2	0.56	65,0	2.56
4S16FLB16	-16	25	-16	44,4	1.75	126,0	4.96	86,2	3.39	19,2	0.76	71,0	2.80
4S16FLB16.116	-16	25	-16	44,4	1.75	126,0	4.96	86,2	3.39	19,2	0.76	116,0	4.57
4S20FLB16	-20	25	-16	50,8	2.00	145,2	5.72	105,4	4.15	19,2	0.76	89,0	3.50
4S24FLB16	-24	25	-16	60,4	2.38	136,5	5.37	96,8	3.81	19,2	0.76	81,9	3.22
4S16FLB20	-16	31	-20	44,4	1.75	147,1	5.79	91,9	3.62	25,2	0.99	71,0	2.80
4S20FLB20	-20	31	-20	50,8	2.00	161,8	6.37	106,5	4.19	25,2	0.99	89,0	3.50
4S24FLB20	-24	31	-20	60,4	2.38	152,9	6.02	97,9	3.85	25,2	0.99	81,9	3.22
4S24FLB24	-24	38	-24	60,3	2.37	208,9	8.22	130,9	5.15	31,1	1.22	104,0	4.09
4S32FLB24	-32	38	-24	71,4	2.81	247,4	9.74	169,4	6.67	31,1	1.22	138,0	5.43
4S32FLB32	-32	51	-32	71,4	2.81	250,3	9.85	172,2	6.78	42,1	1.66	138,0	5.43
6S	Dash size	DN	Dash size	mm	in	mm	in	mm	in	mm	in	mm	in
6S16FLB16	-16	25	-16	44,4	1.75	126,0	4.96	86,2	3.39	19,2	0.76	71,0	2.80
6S20FLB16	-20	25	-16	50,8	2.00	145,2	5.72	105,4	4.15	19,2	0.76	89,0	3.50
6S20FLB20	-20	31	-20	50,8	2.00	162,5	6.40	106,5	4.19	25,2	0.99	89,0	3.50
6S24FLB24	-24	38	-24	60,3	2.37	208,8	8.22	130,8	5.15	31,1	1.22	104,0	4.09
6S32FLB24	-32	38	-24	71,4	2.81	247,4	9.74	169,4	6.67	31,1	1.22	138,0	5.43
6S32FLB32	-32	51	-32	71,4	2.81	250,3	9.85	172,2	6.78	42,1	1.66	138,0	5.43

Crimp fittings

Spiral hose fittings (4S/6S Series)

H

4S Fittings

For use with hose:

EC525-12,-16,-20,-24,-32;
GH493-12,-16,-20,-24,-32;
FC636-12,-16,-20,-24,-32;
FC736-12,-16,-20,-24,-32;

6S Fittings

For use with hose:

FC500-32;
FC273B-20,-24,-32;
FC606-16,-20,-24;
EC810-20,-24,-32;
GH466-20,-24

SAE Code 61 Flange (FLH)

110° Elbow

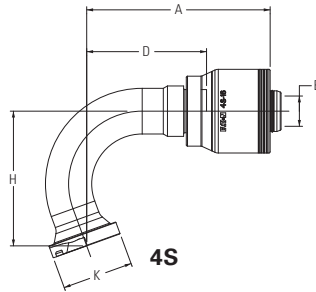

# Part Number	Terminal End	Hose Size		Flange Head Dia. K Ø		A		D		E Ø		H	
		DN	Dash size	mm	in	mm	in	mm	in	mm	in	mm	in
4S16FLH16	-16	25	-16	44,4	1.75	114,6	4.51	74,9	2.95	19,2	0.76	85,2	3.35

SAE Code 62 Flange (FH)

Straight

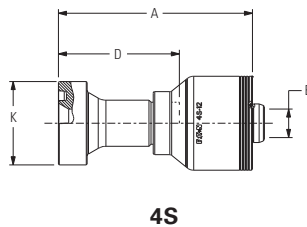

# Part Number	Terminal End	Hose Size		Flange Head Dia. K Ø		A		D		E Ø	
		DN	Dash size	mm	in	mm	in	mm	in	mm	in
4S12FH12	-12	19	-12	41,3	1.63	90,7	3.57	54,5	2.15	14,2	0.56
4S16FH12	-16	19	-12	47,7	1.88	90,2	3.55	54,0	2.13	14,2	0.56
4S12FH16	-12	25	-16	41,3	1.63	96,3	3.79	56,7	2.23	14,2	0.56
4S16FH16	-16	25	-16	47,7	1.88	98,9	3.89	59,1	2.33	19,2	0.76
4S20FH16	-20	25	-16	54,0	2.13	100,8	3.97	61,0	2.40	19,2	0.76
4S16FH20	-16	31	-20	47,7	1.88	123,8	4.87	68,6	2.70	25,2	0.99
4S20FH20	-20	31	-20	54,0	2.13	123,3	4.85	68,1	2.68	25,2	0.99
4S24FH20	-24	31	-20	63,5	2.50	129,0	5.08	73,9	2.91	25,2	0.99
4S24FH24	-24	38	-24	63,5	2.50	189,6	7.46	111,6	4.39	31,1	1.22
4S32FH24	-32	38	-24	79,4	3.13	204,4	8.05	126,4	4.89	31,1	1.22
4S32FH32	-32	51	-32	79,4	3.13	202,7	7.98	124,7	4.91	42,1	1.66
6S	Dash size	DN	Dash size	mm	in	mm	in	mm	in	mm	in
6S16FH16	-16	25	-16	47,7	1.88	98,8	3.89	59,2	2.33	19,2	0.76
6S20FH16	-20	25	-16	54,0	2.13	100,8	3.97	61,0	2.40	19,2	0.76
6S20FH20	-20	31	-20	54,0	2.13	124,0	4.88	68,1	2.68	25,2	0.99
6S24FH20	-24	31	-20	63,5	2.50	129,8	5.11	73,9	2.91	25,2	0.99
6S24FH24	-24	38	-24	63,5	2.50	189,6	7.46	111,6	4.39	31,1	1.22
6S32FH24	-32	38	-24	79,4	3.13	204,4	8.05	126,4	4.98	31,1	1.22
6S32FH32	-32	51	-32	79,4	3.13	202,7	7.98	124,7	4.91	42,1	1.66

SAE Code 62 Flange (FHD)

22.5° Elbow

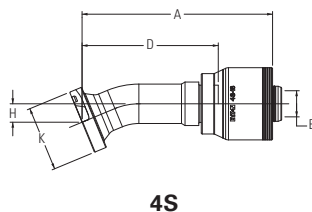

# Part Number	Terminal End	Hose Size		Flange Head Dia. K Ø		A		D		E Ø		H	
		DN	Dash size	mm	in	mm	in	mm	in	mm	in	mm	in
4S16FHD16	-16	25	-16	47,7	1.88	140,0	5.51	100,1	3.94	19,2	0.76	13,5	0.53
4S20FHD16	-20	25	-16	54,0	2.13	160,9	6.33	121,2	4.77	19,2	0.76	16,3	0.64
4S32FHD32	-32	51	-32	79,4	3.13	269,6	10.61	191,5	7.54	42,1	1.66	23,5	0.93

4S Fittings

For use with hose:

EC525-12,-16,-20,-24,-32;
GH493-12,-16,-20,-24,-32;
FC636-12,-16,-20,-24,-32;
FC736-12-16,-20,-24,-32;

FC500-12,-16,-20,-24;
FC273B-12,-16;
GH506-12,-16,-20,-24,-32;
FC254-12,-16,-20,-24,-32;
EC810-12,-16;

6S Fittings

For use with hose:

FC500-32;
FC273B-20,-24,-32;
FC606-16,-20,-24;
EC810-20,-24,-32;
GH466-20,-2

SAE Code 62 Flange (FHF)

30° Elbow

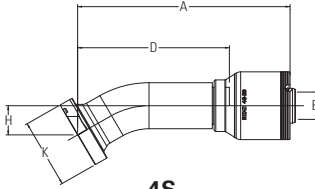

4S

# Part Number	Terminal End Dash size	Hose Size		Flange Head Dia. K Ø		A		D		E Ø		H	
		DN	Dash size	mm	in	mm	in	mm	in	mm	in	mm	in
4S24FHF20	-24	31	-20	63,5	2.50	192,6	7.58	137,6	5.42	25,2	0.99	26,8	1.06
4S32FHF32	-32	51	-32	79,4	3.13	265,8	10.47	187,8	7.39	42,1	1.66	33,9	1.34

SAE Code 62 Flange (FHA)

45° Elbow

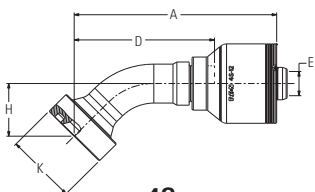

4S

# Part Number	Terminal End Dash size	Hose Size		Flange Head Dia. K Ø		A		D		E Ø		H	
		DN	Dash size	mm	in	mm	in	mm	in	mm	in	mm	in
4S12FHA12	-12	19	-12	41,3	1.63	113,8	4.48	77,6	3.06	14,2	0.56	27,0	1.06
4S16FHA12	-16	19	-12	47,7	1.88	128,0	5.04	91,7	3.61	14,2	0.56	32,0	1.26
4S12FHA16	-12	25	-16	41,3	1.63	116,9	4.60	77,2	3.04	15,1	0.59	27,0	1.06
4S16FHA16	-16	25	-16	47,7	1.88	130,9	5.15	91,2	3.59	19,2	0.76	32,0	1.26
4S20FHA16	-20	25	-16	54,0	2.13	150,2	5.91	110,5	4.35	19,2	0.76	39,0	1.54
4S20FHA20	-20	31	-20	54,0	2.13	166,6	6.56	111,6	4.39	25,2	0.99	39,0	1.54
4S24FHA20	-24	31	-20	63,5	2.50	183,2	7.21	128,2	5.05	25,2	0.99	45,0	1.77
4S24FHA24	-24	38	-24	63,5	2.50	214,1	8.43	136,1	5.36	31,1	1.22	45,0	1.77
4S32FHA24	-32	38	-24	79,4	3.13	251,0	9.88	173,0	6.81	31,1	1.22	57,5	2.26
4S32FHA32	-32	51	-32	79,4	3.13	253,9	10.00	175,9	6.93	42,1	1.66	57,5	2.26
6S	Dash size	DN	Dash size	mm	in	mm	in	mm	in	mm	in	mm	in
6S16FHA16	-16	25	-16	47,7	1.88	130,9	5.15	91,2	3.59	19,2	0.76	32,0	1.26
6S20FHA16	-20	25	-16	54,0	2.13	150,2	5.91	110,0	4.35	19,0	0.75	39,0	1.54
6S20FHA20	-20	31	-20	54,0	2.13	167,6	6.60	111,6	4.39	25,2	0.99	39,0	1.54
6S24FHA20	-24	31	-20	63,5	2.50	184,2	7.25	128,2	5.05	25,2	0.99	45,0	1.77
6S24FHA24	-24	38	-24	63,5	2.50	214,1	8.43	136,1	5.36	31,1	1.22	45,0	1.77
6S32FHA24	-32	38	-24	79,4	3.13	251,0	9.88	173,0	6.81	31,1	1.22	57,5	2.26
6S32FHA32	-32	51	-32	79,4	3.13	253,9	10.00	175,9	6.93	42,1	1.66	57,5	2.26

SAE Code 62 Flange (FHG)

60° Elbow

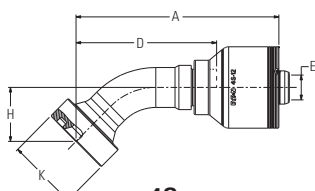

4S

# Part Number	Terminal End Dash size	Hose Size		Flange Head Dia. K Ø		A		D		E Ø		H	
		DN	Dash size	mm	in	mm	in	mm	in	mm	in	mm	in
4S12FHG12	-12	19	-12	41,3	1.63	133,9	5.27	97,7	3.85	14,2	0.56	37,6	1.48
4S16FHG16	-16	25	-16	47,7	1.88	156,4	6.16	116,6	4.59	19,2	0.76	44,6	1.76
4S32FHG32	-32	51	-32	79,4	3.13	309,1	12.17	231,1	9.10	42,1	1.66	85,8	3.38
6S	Dash size	DN	Dash size	mm	in	mm	in	mm	in	mm	in	mm	in
6S16FHG16	-16	25	-16	47,7	1.88	156,4	6.16	116,6	4.59	19,2	0.76	44,7	1.76
6S20FHG16	-20	25	-16	54,0	2.13	183,3	7.22	143,5	5.65	19,2	0.76	55,8	2.20
6S20FHG20	-20	31	-20	54,0	2.13	200,6	7.90	144,6	5.69	25,2	0.99	55,8	2.20

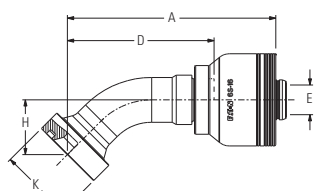

6S

Crimp fittings

Spiral hose fittings (4S/6S Series)

H

4S Fittings

For use with hose:

EC525-12,-16,-20,-24,-32;
GH493-12,-16,-20,-24,-32;
FC636-12,-16,-20,-24,-32;
FC736-12,-16,-20,-24,-32;

FC500-12,-16,-20,-24;
FC273B-12,-16; GH506-12,-
16,-20,-24,-32; FC254-12,-16,-
20,-24,-32; EC810-12,-16;

6S Fittings

For use with hose:

FC500-32;
FC273B-20,-24,-32;
FC606-16,-20,-24;
EC810-20,-24,-32;
GH466-20,-24

SAE Code 62 Flange (FHE)

67.5° Elbow

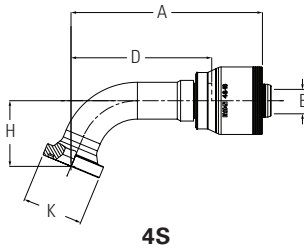

# Part Number	Terminal End	Hose Size		Flange Head Dia. K Ø		A		D		E Ø		H	
		Dash size	DN	Dash size	mm	in	mm	in	mm	in	mm	in	mm
4S32FHE32	-32	51	-32	79,4	3.13	297,0	11.69	219,0	8.62	42,1	1.66	99,3	3.91

SAE Code 62 Flange (FHB)

90° Elbow

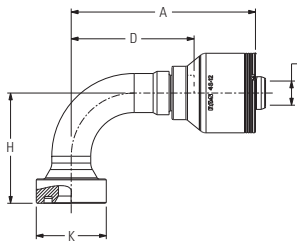

# Part Number	Terminal End	Hose Size		Flange Head Dia. K Ø		A		D		E Ø		H	
		Dash size	DN	Dash size	mm	in	mm	in	mm	in	mm	in	mm
4S12FHB12	-12	19	-12	41,3	1.63	108,5	4.27	72,3	2.85	14,2	0.56	59,0	2.32
4S16FHB12	-16	19	-12	47,7	1.88	122,9	4.84	86,6	3.41	14,2	0.56	71,0	2.80
4S16FHB16	-16	25	-16	47,7	1.88	125,5	4.94	86,1	3.39	19,2	0.76	71,0	2.80
4S16FHB16.120	-16	25	-16	47,7	1.88	126,0	4.96	86,2	3.39	19,2	0.76	120,0	4.72
4S20FHB16	-20	25	-16	54,0	2.13	145,3	5.72	105,4	4.15	19,2	0.76	89,0	3.50
4S16FHB20	-16	31	-20	47,7	1.88	147,1	5.79	91,9	3.62	25,2	0.99	71,0	2.80
4S20FHB20	-20	31	-20	54,0	2.13	161,5	6.36	106,5	4.19	25,2	0.99	89,0	3.50
4S20FHB20.120	-20	31	-20	54,0	2.13	161,5	6.36	106,5	4.19	25,2	0.99	120,0	4.72
4S24FHB20	-24	31	-20	63,5	2.50	178,0	7.01	123,0	4.84	25,2	0.99	104,0	4.09
4S24FHB24	-24	38	-24	63,5	2.50	208,9	8.22	130,8	5.15	31,1	1.22	104,0	4.09
4S32FHB24	-32	38	-24	79,4	3.13	247,4	9.74	169,4	6.67	31,1	1.22	138,0	5.43
4S32FHB32	-32	51	-32	79,4	3.13	250,3	9.85	172,2	6.78	42,1	1.66	138,0	5.43
6S	Dash size	DN	Dash size	mm	in	mm	in	mm	in	mm	in	mm	in
6S16FHB16	-16	25	-16	47,7	1.88	125,5	4.94	86,1	3.39	19,2	0.76	71,0	2.80
6S20FHB16	-20	25	-16	54,0	2.13	145,3	5.72	105,4	4.15	19,2	0.76	89,0	3.50
6S16FHB20	-16	31	-20	47,7	1.88	147,9	5.82	91,9	3.62	25,2	0.99	71,0	2.80
6S20FHB20	-20	31	-20	54,0	2.13	162,5	6.40	106,5	4.19	25,2	0.99	89,0	3.50
6S24FHB20	-24	31	-20	63,5	2.50	179,0	7.05	123,0	4.84	25,2	0.99	104,0	4.09
6S24FHB24	-24	38	-24	63,5	2.50	208,9	8.22	130,8	5.15	31,1	1.22	104,0	4.09
6S32FHB24	-32	38	-24	79,4	3.13	247,4	9.74	169,4	6.67	31,1	1.22	138,0	5.43
6S32FHB32	-32	51	-32	79,4	3.13	250,3	9.85	172,2	6.78	42,1	1.66	138,0	5.43

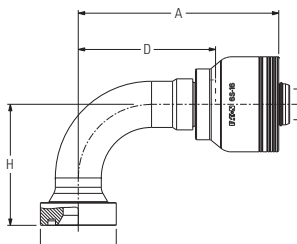

4S Fittings

For use with hose:

EC525-12,-16,-20,-24,-32;
GH493-12,-16,-20,-24,-32;
FC636-12,-16,-20,-24,-32;
FC736-12,-16,-20,-24,-32;

FC500-12,-16,-20,-24;
FC273B-12,-16; GH506-12,-
16,-20,-24,-32; FC254-12,-16,-
20,-24,-32; EC810-12,-16;

6S Fittings

For use with hose:

FC500-32;
FC273B-20,-24,-32;
FC606-16,-20,-24;
EC810-20,-24,-32;
GH466-20,-24

CAT Flange (CT)

Straight

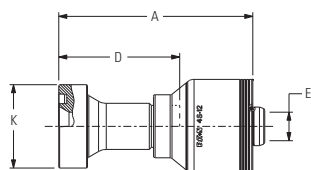

4S

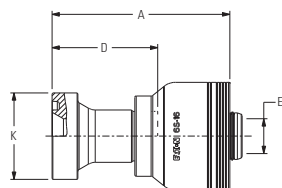

6S

# Part Number	Terminal End	Hose Size		Flange Head Dia. K Ø		A		D		E Ø	
		DN	Dash size	mm	in	mm	in	mm	in	mm	in
4S12CT12	-12	19	-12	41,3	1.63	96,2	3.79	60,0	2.36	14,2	0.56
4S16CT12	-16	19	-12	47,6	1.87	94,9	3.74	58,7	2.31	14,2	0.56
4S16CT16	-16	25	-16	47,6	1.87	102,1	4.02	62,3	2.45	19,2	0.76
4S20CT16	-20	25	-16	54,0	2.13	104,8	4.13	65,0	2.56	19,2	0.76
4S20CT20	-20	31	-20	54,0	2.13	124,5	4.90	69,1	2.72	25,2	0.99
4S24CT20**	-24	31	-20	63,5	2.50	130,9	5.15	75,9	2.99	25,2	0.99
4S24CT24	-24	38	-24	63,5	2.50	195,0	7.68	117,0	4.61	31,1	1.22
4S32CT24	-32	38	-24	79,4	3.13	206,0	8.11	128,0	5.04	31,1	1.22
4S32CT32	-32	51	-32	79,4	3.13	208,9	8.22	130,9	5.15	42,1	1.66
6S	Dash size	DN	Dash size	mm	in	mm	in	mm	in	mm	in
6S16CT16	-16	25	-16	47,6	1.87	102,1	4.02	62,3	2.45	19,2	0.76
6S20CT16	-20	25	-16	54,0	2.13	104,8	4.13	65,0	2.56	19,2	0.76
6S20CT20	-20	31	-20	54,0	2.13	125,2	4.93	69,1	2.72	25,2	0.99
6S24CT20	-24	31	-20	63,5	2.50	131,8	5.19	75,9	2.99	25,2	0.99
6S24CT24	-24	38	-24	63,5	2.50	195,0	7.68	117,0	4.61	31,1	1.22
6S32CT24	-32	38	-24	79,4	3.13	206,0	8.11	128,1	5.04	31,1	1.22
6S32CT32	-32	51	-32	79,4	3.13	208,9	8.22	130,9	5.15	42,1	1.66

CAT Flange (CTD)

22.5° Elbow

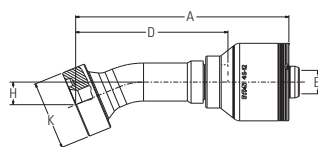

4S

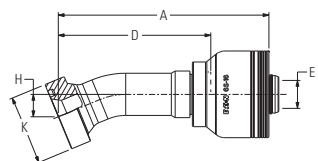

6S

# Part Number	Terminal End	Hose Size		Flange Head Dia. K Ø		A		D		E Ø		H	
		DN	Dash size	mm	in	mm	in	mm	in	mm	in	mm	in
4S12CTD12	-12	19	-12	41,3	1.63	126,2	4.97	90,2	3.55	14,2	0.56	13,6	0.54
4S16CTD16	-16	25	-16	47,6	1.87	144,2	5.68	104,4	4.11	19,2	0.76	15,3	0.60
4S20CTD16	-20	25	-16	54,0	2.13	164,5	6.48	124,8	4.91	19,2	0.76	17,8	0.70
4S20CTD20**	-20	31	-20	54,0	2.13	180,9	7.12	125,9	4.96	25,2	0.99	17,8	0.70
4S24CTD20**	-24	31	-20	63,5	2.50	197,0	7.76	142,0	5.59	25,2	0.99	19,4	0.76
4S24CTD24	-24	38	-24	63,5	2.50	227,9	8.97	149,9	5.90	31,1	1.22	19,4	0.76
4S32CTD32	-32	51	-32	79,4	3.13	271,1	10.67	193,0	7.60	42,1	1.66	24,2	0.95
6S	Dash size	DN	Dash size	mm	in	mm	in	mm	in	mm	in	mm	in
6S16CTD16	-16	25	-16	47,6	1.87	144,2	5.68	104,4	4.11	19,2	0.76	15,3	0.60
6S20CTD16	-20	25	-16	54,0	2.13	164,5	6.48	124,8	4.91	19,2	0.76	17,8	0.70
6S20CTD20	-20	31	-20	54,0	2.13	181,9	7.16	125,9	4.96	25,2	0.99	17,8	0.70
6S24CTD20	-24	31	-20	63,5	2.50	198,0	7.80	142,0	5.59	25,2	0.99	19,4	0.76
6S24CTD24	-24	38	-24	63,5	2.50	227,9	8.97	149,9	5.90	31,1	1.22	19,4	0.76
6S32CTD32	-32	51	-32	79,4	3.13	271,1	10.67	193,0	7.60	42,1	1.66	24,2	0.95

Crimp fittings

Spiral hose fittings
(4S/6S Series)

H

4S Fittings

For use with hose:

EC525-12,-16,-20,-24,-32;
GH493-12,-16,-20,-24,-32;
FC636-12,-16,-20,-24,-32;
FC736-12,-16,-20,-24,-32;

6S Fittings

For use with hose:

FC500-32;
FC273B-20,-24,-32;
FC606-16,-20,-24;
EC810-20,-24,-32;
GH466-20,-24

CAT Flange (CTF)

30° Elbow

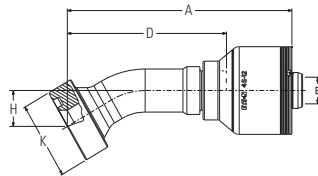

4S

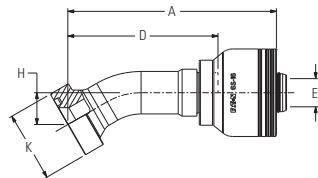

6S

# Part Number	Terminal End	Hose Size		Flange Head Dia. K Ø		A		D		E Ø		H	
		DN	Dash size	mm	in	mm	in	mm	in	mm	in	mm	in
4S12CTF12	-12	19	-12	41,3	1.63	124,2	4.89	88,0	3.46	14,2	0.56	19,1	0.75
4S16CTF16	-16	25	-16	47,6	1.87	141,7	5.58	102,0	4.02	19,2	0.76	21,6	0.85
4S20CTF16	-20	25	-16	54,0	2.13	161,7	6.37	122,0	4.80	19,2	0.76	25,3	1.00
4S20CTF20**	-20	31	-20	54,0	2.13	178,1	7.01	123,1	4.85	25,2	0.99	25,3	1.00
4S24CTF20**	-24	31	-20	63,5	2.50	194,0	7.64	138,9	5.47	25,2	0.99	27,7	1.09
4S24CTF24	-24	38	-24	63,5	2.50	224,8	8.85	146,8	5.78	31,1	1.22	27,7	1.09
4S32CTF32	-32	51	-32	79,4	3.13	267,3	10.52	189,2	7.45	42,1	1.66	34,8	1.37
6S16CTF16	-16	25	-16	47,6	1.87	141,7	5.58	102,0	4.02	19,2	0.76	21,6	0.85
6S20CTF16	-20	25	-16	54,0	2.13	161,7	6.37	122,0	4.80	19,2	0.76	25,3	1.00
6S20CTF20	-20	31	-20	54,0	2.13	179,1	7.05	123,1	4.85	25,2	0.99	25,3	1.00
6S24CTF20	-24	31	-20	63,5	2.50	194,9	7.67	138,9	5.47	25,2	0.99	27,7	1.09
6S24CTF24	-24	38	-24	63,5	2.50	224,8	8.85	146,8	5.78	31,1	1.22	27,7	1.09
6S32CTF24	-32	38	-24	79,4	3.13	264,3	10.41	186,3	7.34	31,1	1.22	34,8	1.37
6S32CTF32	-32	51	-32	79,4	3.13	267,3	10.52	189,2	7.45	42,1	1.66	34,8	1.37

CAT Flange (CTA)

45° Elbow

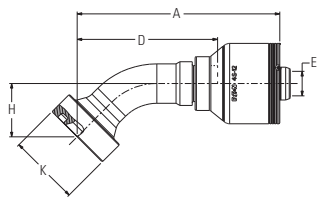

4S

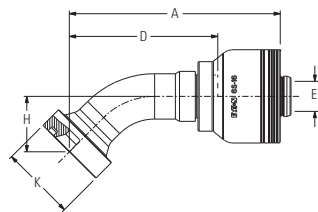

6S

# Part Number	Terminal End	Hose Size		Flange Head Dia. K Ø		A		D		E Ø		H	
		DN	Dash size	mm	in	mm	in	mm	in	mm	in	mm	in
4S12CTA12	-12	19	-12	41,3	1.63	117,7	4.63	81,5	3.21	14,2	0.56	30,9	1.22
4S16CTA12	-16	19	-12	47,6	1.87	131,2	5.17	95,0	3.74	14,2	0.56	35,3	1.39
4S16CTA16	-16	25	-16	47,6	1.87	134,3	5.29	94,6	3.72	19,2	0.76	35,3	1.39
4S20CTA16	-20	25	-16	54,0	2.13	153,0	6.02	113,2	4.46	19,2	0.76	41,8	1.65
4S20CTA20	-20	31	-20	54,0	2.13	169,4	6.67	114,3	4.50	25,2	0.99	41,8	1.65
4S24CTA20**	-24	31	-20	63,5	2.50	184,3	7.26	129,1	5.08	25,2	0.99	46,2	1.82
4S24CTA24	-24	38	-24	63,5	2.50	215,2	8.47	137,2	5.40	31,1	1.22	46,2	1.82
4S32CTA32	-32	51	-32	79,4	3.13	255,1	10.04	177,0	6.97	42,1	1.66	58,7	2.31
6S16CTA16	-16	25	-16	47,6	1.87	134,3	5.29	94,6	3.72	19,2	0.76	35,3	1.39
6S20CTA16	-20	25	-16	54,0	2.13	153,0	6.02	113,2	4.46	19,2	0.76	41,8	1.65
6S20CTA20	-20	31	-20	54,0	2.13	170,3	6.70	114,3	4.50	25,2	0.99	41,8	1.65
6S24CTA20	-24	31	-20	63,5	2.50	185,3	7.30	129,1	5.08	25,2	0.99	46,2	1.82
6S24CTA24	-24	38	-24	63,5	2.50	215,2	8.47	137,2	5.40	31,1	1.22	46,2	1.82
6S32CTA24	-32	38	-24	79,4	3.13	252,2	9.93	174,2	6.86	31,1	1.22	58,7	2.31
6S32CTA32	-32	51	-32	79,4	3.13	255,1	10.04	177,0	6.97	42,1	1.66	58,7	2.31

4S Fittings

For use with hose:

EC525-12,-16,-20,-24,-32;
GH493-12,-16,-20,-24,-32;
FC636-12,-16,-20,-24,-32;
FC736-12,-16,-20,-24,-32;

6S Fittings

For use with hose:

FC500-32;
FC273B-20,-24,-32;
FC606-16,-20,-24;
EC810-20,-24,-32;
GH466-20,-24

CAT Flange (CTG)

60° Elbow

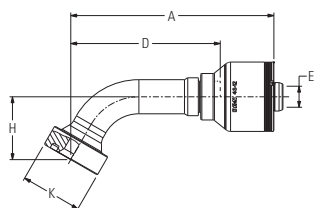

4S

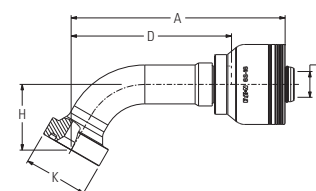

6S

# Part Number	Terminal End Dash size	Hose Size		Flange Head Dia. K Ø		A		D		E Ø		H	
		DN	Dash size	mm	in	mm	in	mm	in	mm	in	mm	in
4S12CTG12	-12	19	-12	41,3	1.63	136,6	5.38	100,5	3.96	14,2	0.56	42,3	1.67
4S16CTG16	-16	25	-16	47,6	1.87	158,8	6.25	119,0	4.69	19,2	0.76	48,7	1.92
4S20CTG16	-20	25	-16	54,0	2.13	185,2	7.29	145,5	5.73	19,2	0.76	59,2	2.33
4S20CTG20**	-20	31	-20	54,0	2.13	201,6	7.94	146,6	5.77	25,2	0.99	59,2	2.33
4S24CTG20**	-24	31	-20	63,5	2.50	223,3	8.79	168,3	6.63	25,2	0.99	66,6	2.62
4S24CTG24	-24	38	-24	63,5	2.50	254,2	10.01	176,2	6.94	31,1	1.22	66,6	2.62
4S32CTG32	-32	51	-32	79,4	3.13	310,0	12.20	231,9	9.13	42,1	1.66	87,3	3.44
6S16CTG16	-16	25	-16	47,6	1.87	158,8	6.25	119,0	4.69	19,2	0.76	48,7	1.92
6S20CTG16	-20	25	-16	54,0	2.13	185,2	7.29	145,5	5.73	19,2	0.76	59,2	2.33
6S20CTG20	-20	31	-20	54,0	2.13	202,6	7.98	146,6	5.77	25,2	0.99	59,2	2.33
6S24CTG20	-24	31	-20	63,5	2.50	224,3	8.83	168,3	6.63	25,2	0.99	66,6	2.62
6S24CTG24	-24	38	-24	63,5	2.50	254,2	10.01	176,2	6.94	31,1	1.22	66,6	2.62
6S32CTG24	-32	38	-24	79,4	3.13	307,0	12.09	229,0	9.02	31,1	1.22	87,3	3.44
6S32CTG32	-32	51	-32	79,4	3.13	310,0	12.20	231,9	9.13	42,1	1.66	87,3	3.44

CAT Flange (CTE)

67.5° Elbow

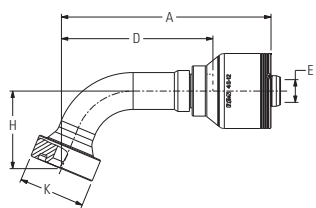

4S

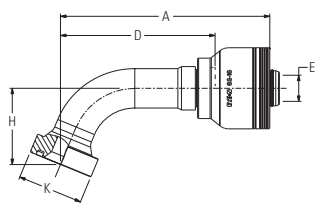

6S

# Part Number	Terminal End Dash size	Hose Size		Flange Head Dia. K Ø		A		D		E Ø		H	
		DN	Dash size	mm	in	mm	in	mm	in	mm	in	mm	in
4S12CTE12	-12	19	-12	41,3	1.63	130,7	5.15	94,5	3.72	14,2	0.56	48,3	1.90
4S16CTE16	-16	25	-16	47,6	1.87	151,9	5.98	112,2	4.42	19,2	0.76	55,8	2.20
4S20CTE16	20	25	-16	54,0	2.13	176,9	6.96	137,1	5.40	19,2	0.76	68,1	2.68
4S20CTE20**	-20	31	-20	54,0	2.13	193,3	7.61	138,3	5.44	25,2	0.99	68,1	2.68
4S24CTE20**	-24	31	-20	63,5	2.50	214,0	8.42	159,0	6.26	25,2	0.99	76,8	3.02
4S24CTE24	-24	38	-24	63,5	2.50	244,8	9.64	166,8	6.57	31,1	1.22	76,8	3.02
4S32CTE32	-32	51	-32	79,4	3.13	297,6	11.72	219,6	8.65	42,1	1.66	100,8	3.97
6S16CTE16	-16	25	-16	47,6	1.87	151,9	5.98	112,2	4.42	19,2	0.76	55,8	2.20
6S20CTE16	-20	25	-16	54,0	2.13	176,9	6.96	137,1	5.40	19,2	0.76	68,1	2.68
6S20CTE20	-20	31	-20	54,0	2.13	194,2	7.65	138,3	5.44	25,2	0.99	68,1	2.68
6S24CTE20	-24	31	-20	63,5	2.50	214,9	8.46	159,0	6.26	25,2	0.99	76,8	3.02
6S24CTE24	-24	38	-24	63,5	2.50	244,8	9.64	166,8	6.57	31,1	1.22	76,8	3.02
6S32CTE24	-32	38	-24	79,4	3.13	294,7	11.60	216,7	8.53	31,1	1.22	100,8	3.97
6S32CTE32	-32	51	-32	79,4	3.13	297,6	11.72	219,6	8.65	42,1	1.66	100,8	3.97

Crimp fittings

Spiral hose fittings (4S/6S Series)

H

4S Fittings

For use with hose:

EC525-12,-16,-20,-24,-32;
GH493-12,-16,-20,-24,-32;
FC636-12,-16,-20,-24,-32;
FC736-12,-16,-20,-24,-32;

6S Fittings

For use with hose:

FC500-32;
FC273B-20,-24,-32;
FC606-16,-20,-24;
EC810-20,-24,-32;
GH466-20,-24

CAT Flange (CTB)

90° Elbow

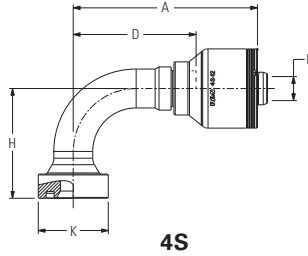

4S

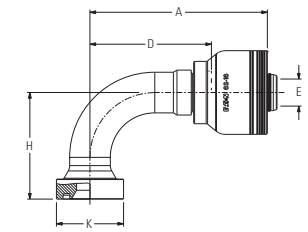

6S

# Part Number	Terminal End	Hose Size		Flange Head Dia. K Ø		A		D		E Ø		H	
		DN	Dash size	mm	in	mm	in	mm	in	mm	in	mm	in
4S12CTB12	-12	19	-12	41,3	1.63	108,5	4.27	72,3	2.85	14,2	0.56	64,5	2.54
4S16CTB12	-16	19	-12	47,6	1.87	122,8	4.83	86,6	3.41	14,2	0.56	75,7	2.98
4S16CTB16	-16	25	-16	47,6	1.87	126,0	4.96	86,2	3.39	19,2	0.76	75,7	2.98
4S20CTB16	-20	25	-16	54,0	2.13	145,2	5.72	105,4	4.15	19,2	0.76	92,9	3.66
4S20CTB20	-20	31	-20	54,0	2.13	161,5	6.36	106,5	4.19	25,2	0.99	92,9	3.66
4S24CTB20**	-24	31	-20	63,5	2.50	178,0	7.11	123,0	4.84	25,2	0.99	105,6	4.16
4S24CTB24	-24	38	-24	63,5	2.50	208,9	8.22	130,9	5.15	31,1	1.22	105,7	4.16
4S32CTB32	-32	51	-32	79,4	3.13	250,3	9.85	172,2	6.78	42,1	1.66	139,7	5.50
6S16CTB16	-16	25	-16	47,6	1.87	126,0	4.96	86,2	3.39	19,2	0.76	75,7	2.98
6S20CTB16	-20	25	-16	54,0	2.13	145,2	5.72	105,4	4.15	19,2	0.76	92,9	3.66
6S20CTB20	-20	31	-20	54,0	2.13	162,5	6.40	106,5	4.19	25,2	0.99	92,9	3.66
6S24CTB20	-24	31	-20	63,5	2.50	179,0	7.05	123,0	4.84	25,2	0.99	105,6	4.16
6S24CTB24	-24	38	-24	63,5	2.50	208,9	8.22	130,9	5.15	31,1	1.22	105,7	4.16
6S32CTB24	-32	38	-24	79,4	3.13	247,4	9.74	169,4	6.67	31,1	1.22	139,7	5.50
6S32CTB32	-32	51	-32	79,4	3.13	250,3	9.85	172,2	6.78	42,1	1.66	139,7	5.50

BSP Male tapered rigid (BT)

Straight

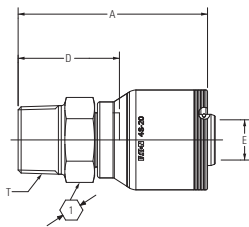

4S

# Part Number	Terminal End	Hose Size		Thread	A		D		E Ø		1
		DN	Dash size		mm	in	mm	in	mm	in	
4S12BT12	-12	19	-12	R 3/4-14	84,0	3.31	47,7	1.88	14,2	0.56	27,0
4S16BT16	-16	25	-16	R 1-11	94,9	3.74	55,2	2.17	19,2	0.76	36,0
4S20BT20	-20	31	-20	R 1 1/4-11	118,4	4.66	63,3	2.49	25,2	0.99	46,0

"R" as part of thread size is ISO designation for tapered thread.

BSP Male parallel rigid (BP)

60° Cone Seat
Straight

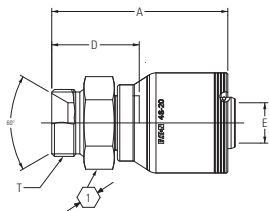

4S

# Part Number	Terminal End	Hose Size		Thread	A		D		E Ø		1
		DN	Dash size		mm	in	mm	in	mm	in	
4S12BP12	-12	19	-12	G 3/4-14	79,6	3.13	43,4	1.71	14,2	0.56	32,0
4S16BP16	-16	25	-16	G 1-11	89,8	3.53	50,1	1.97	19,2	0.75	41,0
4S20BP20	-20	31	-20	G 1 1/4-11	109,7	4.32	54,5	2.15	25,1	0.99	50,0

"G" as part of thread size is ISO designation for parallel thread.

4S Fittings

For use with hose:

EC525-12,-16,-20,-24,-32;
GH493-12,-16,-20,-24,-32;
FC636-12,-16,-20,-24,-32;
FC736-12,-16,-20,-24,-32;

6S Fittings

For use with hose:

FC500-32;
FC273B-20,-24,-32;
FC606-16,-20,-24;
EC810-20,-24,-32;
GH466-20,-24

Female BSPP swivel (BF)

60° Cone Seat
Straight

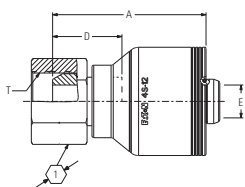

4S

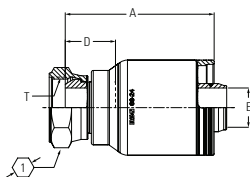

6S

# Part Number	Terminal End	Hose Size		Thread	A		D		E Ø		1
		DN	Dash size		in	mm	in	mm	in	mm	
4S12BF12	-12	19	-12	G 3/4	66,2	2.61	29,9	1.18	14,2	0.56	32,0
4S16BF12	-16	19	-12	G 1	68,7	2.70	32,3	1.27	14,2	0.56	41,0
4S16BF16	-16	25	-16	G 1	71,0	2.80	32,3	1.27	19,2	0.76	41,0
4S20BF16	-20	25	-16	G 1 1/4	72,5	2.85	32,7	1.29	19,2	0.76	50,0
4S20BF20	-20	31	-20	G 1 1/4	82,8	3.26	32,7	1.29	25,2	0.99	50,0
4S24BF24	-24	38	-24	G 1 1/2	117,9	4.64	39,8	1.57	31,1	1.22	55,0
4S32BF32	-32	51	-32	G 2	121,0	4.76	43,0	1.69	42,1	1.66	70,0
6S	Dash size	DN	Dash size	in	mm	in	mm	in	mm	in	mm
6S24BF24	-24	38	-24	G 1 1/2	117,9	4.64	39,8	1.57	31,1	1.22	55,0
6S32BF32	-32	51	-32	G 2	121,0	4.76	43,0	1.69	42,1	1.66	70,0

"G" as part of thread size is ISO designation for parallel thread.

Female BSPP swivel (BFA)

60° Cone Seat
45° Elbow

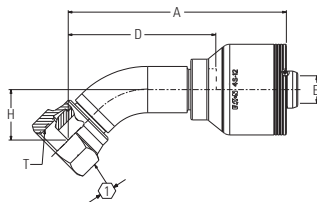

4S

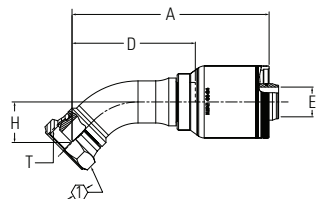

6S

# Part Number	Terminal End	Hose Size		Thread	A		D		E Ø		H	1	
		DN	Dash size		in	mm	in	mm	in	mm	in		mm
4S12BFA12	-12	19	-12	G 3/4	112,3	4.42	75,9	2.99	14,2	0.56	26,0	1.02	32,0
4S16BFA12	-16	19	-12	G 1	115,8	4.56	79,5	3.13	14,2	0.56	30,0	1.18	41,0
4S16BFA16	-16	25	-16	G 1	130,3	5.13	90,6	3.57	19,2	0.76	30,0	1.18	41,0
4S20BFA16	-20	25	-16	G 1 1/4	133,0	5.24	93,4	3.68	19,2	0.76	34,0	1.34	50,0
4S20BFA20	-20	31	-20	G 1 1/4	149,5	5.89	99,1	3.90	25,2	0.99	34,0	1.34	50,0
4S24BFA24	-24	38	-24	G 1 1/2	208,3	8.20	130,3	5.13	31,1	1.22	42,4	1.67	55,0
4S32BFA32	-32	51	-32	G 2	248,4	9.78	170,4	6.71	42,1	1.66	54,1	2.13	70,0
6S	Dash size	DN	Dash size	in	mm	in	mm	in	mm	in	mm	in	mm
6S24BFA24	-24	38	-24	G 1 1/2	208,3	8.20	130,3	5.13	31,1	1.22	42,4	1.67	55,0
6S32BFA32	-32	51	-32	G 2	248,4	9.78	170,4	6.71	42,1	1.66	54,1	2.13	70,0

"G" as part of thread size is ISO designation for parallel thread.

Crimp fittings

Spiral hose fittings (4S/6S Series)

H

4S Fittings

For use with hose:

EC525-12,-16,-20,-24,-32;
GH493-12,-16,-20,-24,-32;
FC636-12,-16,-20,-24,-32;
FC736-12,-16,-20,-24,-32;

FC500-12,-16,-20,-24;
FC273B-12,-16;
GH506-12,-16,-20,-24,-32;
FC254-12,-16,-20,-24,-32;
EC810-12,-16;

6S Fittings

For use with hose:

FC500-32; FC273B-20,-24,-32;
FC606-16,-20,-24;
EC810-20,-24,-32; GH466-20,-24

Female BSPP swivel (BFB)

60° Cone Seat
90° Elbow

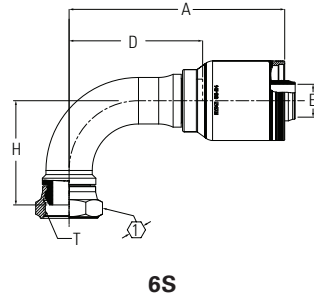
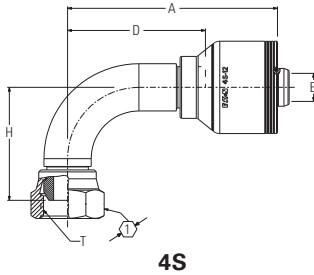

# Part Number	Terminal End	Hose Size		Thread	A		D		E Ø		H		mm
		DN	Dash size		in	mm	in	mm	in	mm	in	mm	
4S12BFB12	-12	19	-12	G 3/4	105,9	4.17	69,6	2.74	14,2	0.56	57,0	2.24	32,0
4S16BFB12	-16	19	-12	G 1	105,9	4.17	69,6	2.74	14,2	0.56	68,0	2.68	41,0
4S16BFB16	-16	25	-16	G 1	125,5	4.94	85,8	3.38	19,2	0.76	68,0	2.68	41,0
4S20BFB16	-20	25	-16	G 1 1/4	125,5	4.94	85,8	3.38	19,2	0.76	79,0	3.11	50,0
4S20BFB20	-20	31	-20	G 1 1/4	145,0	5.71	95,0	3.74	25,2	0.99	79,0	3.11	50,0
4S24BFB24	-24	38	-24	G 1 1/2	205,1	8.07	127,0	5.00	31,1	1.22	98,6	3.88	55,0
4S32BFB32	-32	51	-32	G 2	245,7	9.67	167,6	6.60	42,1	1.66	125,3	4.93	70,0
6S	Dash size	DN	Dash size	in	mm	in	mm	in	mm	in	mm	in	mm
6S24BFB24	-24	38	-24	G 1 1/2	205,1	8.07	127,0	5.00	31,1	1.22	98,6	3.88	55,0
6S32BFB32	-32	51	-32	G 2	245,7	9.67	167,6	6.60	42,1	1.66	125,3	4.93	70,0

"G" as part of thread size is ISO designation for parallel thread.

4S Fittings

For use with hose:

EC525-12,-16,-20,-24,-32;
GH493-12,-16,-20,-24,-32;
FC636-12,-16,-20,-24,-32;
FC736-12,-16,-20,-24,-32;

JIS Female swivel (JF)

30° Flare Seat
Straight

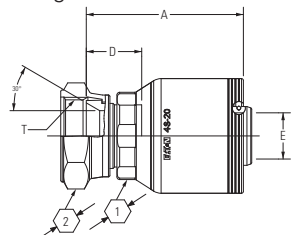

4S

Komatsu Female swivel (KF)

30° Flare Seat
Straight

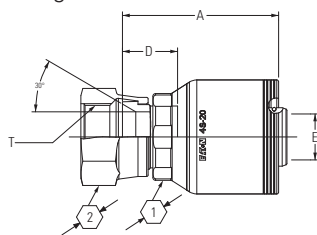

4S

Female swivel DIN 24° seat (DL)

I.Rh DKO (Light)
Straight

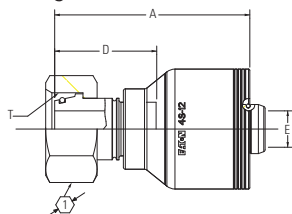

4S

Female swivel DIN 24° Seat (DLB)

I.Rh DKO (Light)
90° Elbow

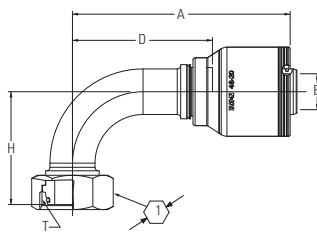

4S

6S Fittings

For use with hose:

FC500-12,-16,-20,-24;
FC273B-12,-16;
GH506-12,-16,-20,-24,-32;
FC254-12,-16,-20,-24,-32;
EC810-12,-16;

FC500-32;
FC273B-20,-24,-32;
FC606-16,-20,-24;
EC810-20,-24,-32;
GH466-20,-24

# Part Number	Terminal End	Hose Size		Thread	A		D		E Ø		1		2
		DN	Dash size		in	mm	in	mm	in	mm	in	mm	
4S12JF12	-12	19	-12	G 3/4	62,4	2.46	26,2	1.03	14,2	0.56	30,0	1 3/16	32,0
4S16JF16	-16	25	-16	G 1	66,6	2.62	26,8	1.06	19,2	0.76	41,0	1 5/8	41,0
4S20JF20	-20	31	-20	G 1 1/4	85,5	3.37	30,2	1.19	25,2	0.99	46,0	1 13/16	50,0

"G" as part of thread size is ISO designation for parallel thread.

# Part Number	Terminal End	Hose Size		Thread	A		D		E Ø		1		2
		DN	Dash size		mm	in	mm	in	mm	in	mm		
4S12KF12	-12	19	-12	M30X1.5	62,4	2.46	26,2	1.03	14,2	0.56	30,0	1 3/16	36,0
4S16KF16	-16	25	-16	M33X1.5	66,6	2.62	26,8	1.06	19,2	0.76	41,0	1 5/8	41,0
4S20KF20	-20	31	-20	M36X1.5	85,5	3.37	30,2	1.19	25,2	0.99	46,0	1 13/16	46,0

# Part Number	Tube O.D.	Hose Size		Thread	A		D		E Ø		1
		DN	Dash size		mm	in	mm	in	mm	in	
4S20DL12	22	19	-12	M30X2	76,0	2.99	39,7	1.56	14,2	0.56	36,0
4S25DL16	28	25	-16	M36X2	79,7	3.14	40,3	1.59	19,2	0.76	41,0
4S32DL20	35	31	-20	M45X2	100,5	3.96	45,5	1.79	25,2	0.99	50,0

# Part Number	Tube O.D.	Hose Size		Thread	A		D		E Ø		H	1	
		DN	Dash size		mm	in	mm	in	mm	in			
4S20DLB12	22	19	-12	M30X2	106,1	4.18	69,8	2.75	14,2	0.56	50,7	2.00	36,0
4S32DLB20	36	31	-20	M45X2	154,2	6.07	99,2	3.90	25,2	0.99	79,0	3.11	50,0

Crimp fittings

Spiral hose fittings (4S/6S Series)

H

4S Fittings

For use with hose:

EC525-12,-16,-20,-24,-32;
GH493-12,-16,-20,-24,-32;
FC636-12,-16,-20,-24,-32;
FC736-12,-16,-20,-24,-32;

FC500-12,-16,-20,-24;
FC273B-12,-16;
GH506-12,-16,-20,-24,-32;
FC254-12,-16,-20,-24,-32;
EC810-12,-16;

6S Fittings

For use with hose:

FC500-32;
FC273B-20,-24,-32;
FC606-16,-20,-24;
EC810-20,-24,-32;
GH466-20,-24

Male DIN 24° Seat Rigid (EK)

S.Rh. DKO (Heavy)
Straight

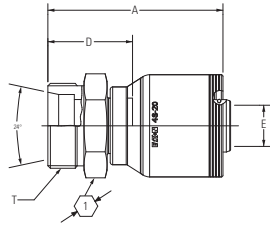

4S

# Part Number	Tube O.D.	Hose Size		Thread	A		D		E Ø		1
		DN	Dash size		mm	in	mm	in	mm	in	
4S20EK12	25	19	-12	M36X2	78,6	3.09	42,3	1.67	14,2	0.56	41,0
4S25EK16	30	25	-16	M42X2	83,7	3.30	44,0	1.73	19,2	0.75	46,0
4S32EK20	38	31	-20	M52X2	106,9	4.21	51,7	2.04	25,2	0.99	55,0

Female Swivel DIN 24° Seat (DS)

S.Rh DKO (Heavy)
Straight

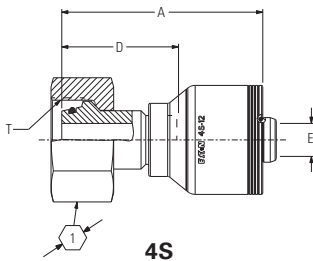

4S

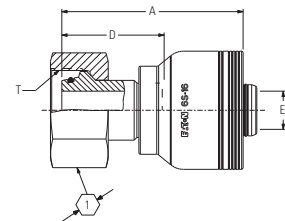

6S

# Part Number	Tube O.D.	Hose Size		Thread	A		D		E Ø		1
		DN	Dash size		mm	in	mm	in	mm	in	
4S16DS12	20	19	-12	M30X2	73,7	2.90	37,4	1.47	14,2	0.56	36,0
4S20DS12	25	19	-12	M36X2	86,6	3.41	50,3	1.98	14,2	0.56	46,0
4S25DS12	30	19	-12	M42X2	88,2	3.47	51,9	2.04	14,2	0.56	50,0
4S25DS16	30	25	-16	M42X2	91,1	3.59	51,4	2.02	19,2	0.76	50,0
4S32DS16	38	25	-16	M52X2	94,5	3.72	55,3	2.18	19,2	0.76	60,0
4S25DS20	30	31	-20	M42X2	96,6	3.80	41,6	1.64	22,1	0.87	50,0
4S32DS20	38	31	-20	M52X2	111,5	4.39	56,5	2.22	25,2	0.99	60,0
6S		DN	Dash size	Metric	mm	in	mm	in	mm	in	mm
6S25DS16	30	25	-16	M42X2	91,1	3.59	51,4	2.02	19,2	0.76	50,0
6S32DS16	38	25	-16	M52X2	95,0	3.74	55,3	2.18	19,2	0.76	60,0
6S32DS20	38	31	-20	M52X2	112,5	4.43	56,5	2.22	25,2	0.99	60,0

4S Fittings

For use with hose:

EC525-12,-16,-20,-24,-32;
GH493-12,-16,-20,-24,-32;
FC636-12,-16,-20,-24,-32;
FC736-12,-16,-20,-24,-32;

FC500-12,-16,-20,-24;
FC273B-12,-16;
GH506-12,-16,-20,-24,-32;
FC254-12,-16,-20,-24,-32;
EC810-12,-16;

6S Fittings

For use with hose:

FC500-32;
FC273B-20,-24,-32;
FC606-16,-20,-24;
EC810-20,-24,-32;
GH466-20,-24

Female Swivel DIN 24° Seat (DSA)

S.Rh DKO (heavy)
45° Elbow

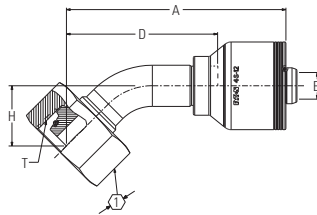

4S

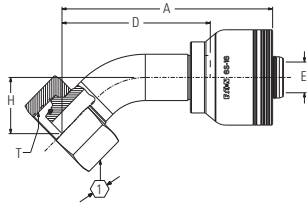

6S

# Part Number	Tube O.D.	Hose Size		Thread	A		D		E Ø		H	1	
		DN	Dash size		mm	in	mm	in	mm	in			
4S													
4S20DSA12	25	19	-12	M36X2	116,7	4.59	80,4	3.17	14,2	0.56	32,0	1.26	46,0
4S25DSA12	30	19	-12	M42X2	130,8	5.15	94,4	3.72	14,2	0.56	35,0	1.38	50,0
4S25DSA16	30	25	-16	M42X2	134,2	5.28	94,4	3.72	19,2	0.76	35,0	1.38	50,0
4S32DSA16	38	25	-16	M52X2	145,1	5.71	105,3	4.15	19,2	0.76	39,0	1.54	60,0
4S32DSA20	38	31	-20	M52X2	161,3	6.35	106,3	4.19	25,2	0.99	39,0	1.54	60,0
6S													
6S25DSA16	30	25	-16	M42X2	134,1	5.28	94,4	3.72	19,2	0.76	35,0	1.38	50,0
6S32DSA16	38	25	-16	M52X2	145,1	5.71	105,3	4.15	19,2	0.76	39,0	1.54	60,0
6S32DSA20	38	31	-20	M52X2	162,4	6.39	106,3	4.19	25,2	0.99	39,0	1.54	60,0

Female swivel DIN 24° Seat (DSB)

S.Rh DKO (heavy)
90° Elbow

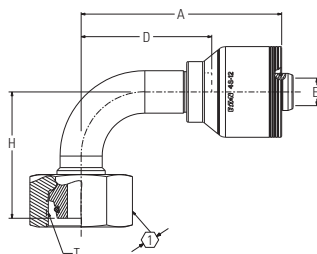

4S

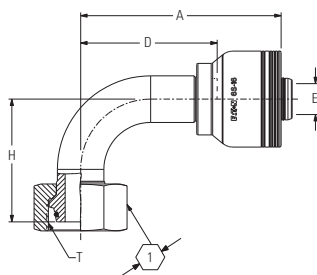

6S

# Part Number	Tube O.D.	Hose Size		Thread	A		D		E Ø		H	1	
		DN	Dash size		mm	in	mm	in	mm	in			
4S													
4S20DSB12	25	19	-12	M36X2	103,9	4.09	67,7	2.67	14,2	0.56	65,0	2.56	46,0
4S25DSB12	30	19	-12	M42X2	122,7	4.83	86,4	3.40	14,2	0.56	76,0	2.99	50,0
4S25DSB16	30	25	-16	M42X2	124,5	4.90	84,8	3.34	19,2	0.76	76,0	2.99	50,0
4S32DSB16	38	25	-16	M52X2	136,7	5.38	97,0	3.82	19,2	0.76	89,0	3.50	60,0
4S32DSB20	38	31	-20	M52X2	153,0	6.02	98,0	3.86	25,2	0.99	89,0	3.50	60,0
6S													
6S25DSB16	30	25	-16	M42X2	124,5	4.90	84,8	3.34	19,2	0.76	76,0	2.99	50,0
6S32DSB16	38	25	-16	M52X2	136,7	5.38	97,0	3.82	19,2	0.76	89,0	3.50	60,0
6S32DSB20	38	31	-20	M52X2	154,2	6.07	98,0	3.86	25,2	0.99	89,0	3.50	60,0

Crimp fittings

Teflon PTFE fittings
(FC Series)

H

PTFE crimp fittings

For use with hose:
2807, FC465, S-TW
and SC-TW

Male pipe
FC9846

SAE 37° (JIC) swivel
FC9779

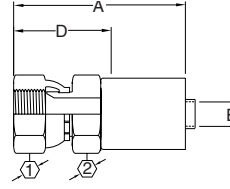
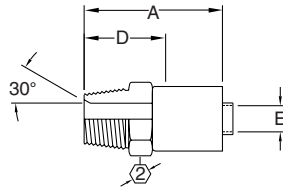

Complete fitting part #	Component part numbers		Thd.	Hose Size	A		D		EØ		1	2
	Nipple assy. part #	Socket part #			mm	in	mm	in	mm	in		

Male pipe

FC9846-0204S*	FC3680-0204S**	FC3596-04S	1/8-27	-04	31,8	1.25	16,8	0.66	3,0	0.12	-	7/16
FC9846-0404S*	FC3680-0404S**	FC3596-04S	1/4-18	-04	38,1	1.50	23,1	0.91	3,0	0.12	-	9/16
FC9846-0405S*	FC3680-0405S**	FC3443-04S	1/4-18	-05	35,6	1.40	23,1	0.91	4,8	0.19	-	9/16
FC9846-0406S*	FC3680-0406S**	FC3443-05S	1/4-18	-06	35,6	1.40	23,1	0.91	6,4	0.25	-	9/16
FC9846-0606S*	FC3680-0606S**	FC3443-05S	3/8-18	-06	35,6	1.40	23,1	0.91	6,4	0.25	-	11/16
FC9846-0608S*	FC3680-0608S**	FC3596-08S	3/8-18	-08	45,7	1.80	23,1	0.91	8,6	0.34	-	11/16
FC9846-0808S*	FC3680-0808S**	FC3596-08S	1/2-14	-08	51,8	2.04	29,5	1.16	8,6	0.34	-	7/8
FC9846-0810S*	FC3680-0810S**	FC3443-08S	1/2-14	-10	51,8	2.04	29,5	1.16	11,2	0.44	-	7/8
FC9846-1212S*	FC3680-1212S**	FC3596-12S	3/4-14	-12	51,8	2.04	29,5	1.16	14,2	0.56	-	1 1/16
FC9846-1616S*	FC3680-1616S**	FC3596-16S	1-11 1/2	-16	58,9	2.32	36,6	1.44	20,3	0.80	-	1 3/8

Male pipe - stainless steel

FC9846-0204-333	FC3680-0204-329	FC3596-04C	1/8-27	-04	31,8	1.25	16,8	0.66	3,0	0.12	-	7/16
FC9846-0404-333	FC3680-0404-329	FC3596-04C	1/4-18	-04	38,1	1.50	23,1	0.91	3,0	0.12	-	9/16
FC9846-0405-333	FC3680-0405-329	FC3443-04C	1/4-18	-05	35,6	1.40	23,1	0.91	4,8	0.19	-	9/16
FC9846-0406-333	FC3680-0406-329	FC3443-05C	1/4-18	-06	35,6	1.40	23,1	0.91	6,4	0.25	-	9/16
FC9846-0606-333	FC3680-0606-329	FC3443-05C	3/8-18	-06	35,6	1.40	23,1	0.91	6,4	0.25	-	11/16
FC9846-0608-333	FC3680-0608-329	FC3596-08C	3/8-18	-08	45,7	1.80	23,1	0.91	8,6	0.34	-	11/16
FC9846-0810-333	FC3680-0810-329	FC3443-08C	1 1/2-14	-10	51,8	2.04	29,5	1.16	11,2	0.44	-	7/8
FC9846-1212-333	FC3680-1212-329	FC3596-12C	3/4-14	-12	51,8	2.04	29,5	1.16	14,2	0.56	-	1 1/16
FC9846-1616-333	FC3680-1616-329	FC3596-16C	1-11 1/2	-16	58,9	2.32	36,6	1.44	20,3	0.80	-	1 3/8

SAE 37° (JIC) swivel

FC9779-0404S†	FC8779-0404S†	FC3596-04S	7/16-20	-04	39,4	1.55	24,4	0.96	3,0	0.12	9/16	7/16
FC9779-0505S†	FC8779-0505S†	FC3443-04S	1 1/2-20	-05	38,1	1.50	25,7	1.01	4,8	0.19	5/8	1/2
FC9779-0606S†	FC8779-0606S†	FC3443-05S	9/16-18	-06	40,6	1.60	28,2	1.11	6,4	0.25	11/16	9/16
FC9779-0808S†	FC8779-0808S†	FC3596-08S	3/4-16	-08	53,3	2.10	30,7	1.21	8,6	0.34	7/8	11/16
FC9779-1010S†	FC8779-1010S†	FC3443-08S	7/8-14	-10	56,1	2.21	33,5	1.32	11,2	0.44	1	13/16
FC9779-1212S†	FC8779-1212S†	FC3596-12S	11/16-12	-12	58,2	2.29	35,8	1.41	14,2	0.56	1 1/4	1
FC9779-1616S†	FC8779-1616S†	FC3596-16S	1 5/16-12	-16	64,0	2.52	41,7	1.64	20,3	0.80	1 1/2	1 1/4

SAE 37° (JIC) swivel - stainless steel

FC9779-0404-333	FC8779-0404-333	FC3596-04C	7/16-20	-04	39,4	1.55	24,4	0.96	3,0	0.12	9/16	7/16
FC9779-0505-333	FC8779-0505-333	FC3443-04C	1/2-20	-05	38,1	1.50	25,7	1.01	4,8	0.19	5/8	1/2
FC9779-0606-333	FC8779-0606-333	FC3443-05C	9/16-18	-06	40,6	1.60	28,2	1.11	6,4	0.25	11/16	9/16
FC9779-0808-333	FC8779-0808-333	FC3596-08C	3/4-16	-08	53,3	2.10	30,7	1.21	8,6	0.34	7/8	11/16
FC9779-1010-333	FC8779-1010-333	FC3443-08C	7/8-14	-10	56,1	2.21	33,5	1.32	11,2	0.44	1	13/16
FC9779-1212-333	FC8779-1212-333	FC3596-12C	1 5/16-12	-12	58,2	2.29	35,8	1.41	14,2	0.56	1 1/4	1
FC9779-1616-333	FC8779-1616-333	FC3596-16C	1 5/16-12	-16	64,0	2.52	41,7	1.64	20,3	0.80	1 1/2	1 1/4

* For brass drop "S" suffix, replace with -38.
**For brass drop "S" suffix, replace with "B".
† For brass drop "S" suffix, replace with -63.

Teflon™ is a trademark of The Chemours Company FC, LLC used under license by Eaton.

PTFE crimp fittings

For use with hose:
2807, FC465, S-TW
and SC-TW

SAE 45° swivel
FC7216

45° elbow universal
FC7220

90° elbow
FC5098 universal
FC7217 SAE 45°

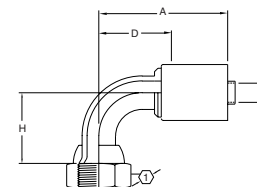
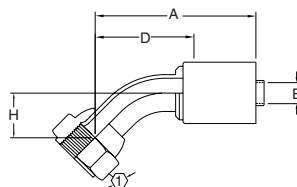
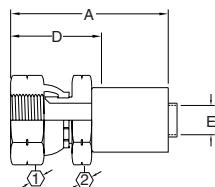

Complete fitting part #	Component part numbers		Thd.	Hose Size	A		D		EØ		H		1	2
	Nipple assy. part #	Socket part #			mm	in	mm	in	mm	in	mm	in		
SAE 45° swivel														
FC7216-0404S	FC6216-0404S†	FC3596-04S	7/16-20	-04	39,4	1.55	24,4	0.96	3,0	0.12	-	-	9/16	7/16
FC7216-0505S	FC6216-0505S††	FC3443-04S	1/2-20	-05	38,1	1.50	25,7	1.01	4,8	0.19	-	-	5/8	1/2
FC7216-0606S	FC6216-0606S†	FC3443-05S	5/8-18	-06	41,4	1.63	29,0	1.14	6,4	0.25	-	-	3/4	9/16
FC7216-0808S	FC6216-0808S†	FC3596-08S	3/4-16	-08	53,3	2.10	30,7	1.21	8,6	0.34	-	-	7/8	11/16
FC7216-1010S	FC6216-1010S†	FC3443-08S	7/8-14	-10	56,1	2.21	33,5	1.32	11,2	0.44	-	-	1	13/16
FC7216-1212S	FC6216-1212S†	FC3596-12S	1 1/16-14	-12	58,2	2.29	35,8	1.41	14,2	0.56	-	-	1 1/4	1
45° elbow														
FC7220-0808S	FC6220-0808S	FC3596-08S	3/4-16	-08	54,9	2.16	32,3	1.27	9,1	0.36	14,0	0.55	7/8	-
90° elbow														
FC5098-0404S	FC4098-0404S	FC3596-04S	7/16-20	-04	32,5	1.28	17,5	0.69	3,0	0.12	17,3	0.68	9/16	-
FC7217-0606S	FC6217-0606S	FC3443-05S	5/8-18	-06	33,3	1.31	20,8	0.82	6,4	0.25	21,6	0.85	3/4	-

*Available with brass nipples, contact Eaton.
† For brass drop "S" suffix, replace with -63.

Crimp fittings

Truck and fuel 100R5
(FJ Series)

H

100R5 crimp fittings

For use with hose: 1503, FC234, FC300, FC350, FC355

SAE 37° (JIC) swivel

FJ3114-

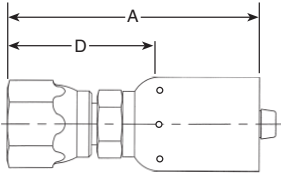

Complete fitting part #	Hose size	Thread	A		D		HEX	
			mm	in	mm	in	mm	in
FJ3114-								
FJ3114-0404S	-04	7/16-20	47,8	1.88	27,9	1.10	14,2	0.56
FJ3114-0604S	-04	9/16-18	51,6	2.03	31,8	1.25	17,5	0.69
FJ3114-0405S	-05	7/16-20	48,0	1.89	27,9	1.10	14,2	0.56
FJ3114-0505S	-05	1/2-20	49,3	1.94	29,2	1.15	12,7	0.5
FJ3114-0606S	-06	9/16-18	51,8	2.04	31,8	1.25	17,5	0.69
FJ3114-0806S	-06	3/4-16	54,4	2.14	34,3	1.35	22,4	0.88
FJ3114-0608S	-08	9/16-18	53,9	2.12	33,5	1.32	17,5	0.69
FJ3114-0808S	-08	3/4-16	54,6	2.15	34,2	1.35	22,4	0.88
FJ3114-1008S	-08	7/8-14	58,9	2.32	38,8	1.53	25,4	1.00
FJ3114-0810S	-10	3/4-16	58,2	2.29	35,8	1.41	22,4	0.88
FJ3114-1010S	-10	7/8-14	61,2	2.41	38,8	1.53	25,4	1.00
FJ3114-1012S	-12	7/8-14	62,0	2.44	39,0	1.54	25,4	1.00
FJ3114-1212S	-12	1 1/16-12	61,7	2.43	39,4	1.55	31,8	1.25
FJ3114-1216S	-16	1 1/16-12	70,9	2.79	45,7	1.80	31,8	1.25
FJ3114-1616S	-16	1 5/16-12	70,4	2.77	43,9	1.73	38,1	1.5
FJ3114-2020S	-20	1 5/8-12	75,4	2.97	45,5	1.79	50,8	2.00
FJ3114-2024S	-24	1 5/8-12	83,2	3.28	45,5	1.79	50,8	2.00
FJ3114-2424S	-24	1 7/8-12	87,1	3.43	49,3	1.94	57,2	2.25
FJ3114-3232S	-32	2 1/2-12	107,9	4.25	59,2	2.33	73,0	2.25

Straight SAE 45° swivel

FJ3094-

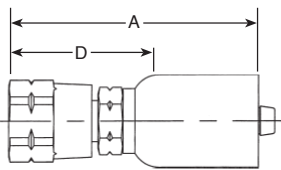

Complete fitting part #	Hose size	Thread	A		D		HEX	
			mm	in	mm	in	mm	in
FJ3094								
FJ3094-0404S	-04	7/16-20	47,8	1.88	26,9	1.10	14,2	0.56
FJ3094-0405S	-05	7/16-20	49,3	1.94	27,9	1.15	14,2	0.56
FJ3094-0505S	-05	1/2-20	53,1	2.09	28,7	1.13	15,8	0.62
FJ3094-0606S	-06	5/8-18	52,7	2.07	32,5	1.28	19,1	0.75
FJ3094-0806S	-06	3/4-16	61,2	2.41	33,5	1.32	22,4	0.88
FJ3094-0808S	-08	3/4-16	54,5	2.15	34,3	1.35	22,4	0.88
FJ3094-0810S	-10	3/4-16	64,5	2.54	36,8	1.45	22,4	0.88
FJ3094-1010S	-10	7/8-14	61,2	2.41	38,8	1.53	25,4	1.00
FJ3094-1012S	-12	7/8-14	68,3	2.69	36,3	1.43	25,4	1.00
FJ3094-1212S	-12	1 1/16-14	61,8	2.43	39,4	1.55	31,8	1.25

* Pictures may not represent actual configuration. Call Eaton Technical Assistance for details.

100R5 crimp fittings

45° elbow

FJ3243 - Universal swivel

FJ3246 - SAE 45° swivel

FJ3249 - SAE 37° (JIC) swivel

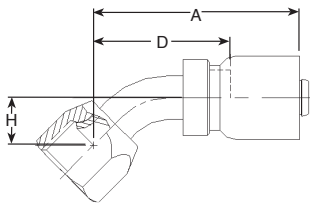

For use with hose: 1503, FC234, FC300, FC350, FC355

Complete fitting part #	Hose size	Thread	A		D		H		HEX	
			mm	in	mm	in	mm	in	mm	in
FJ3243 universal swivel-										
FJ3243-0404S	-04	7/16-20	43,7	1.72	23,9	0.94	8,3	0.33	14,2	0.56
FJ3243-0405S	-05	7/16-20	43,9	1.73	23,8	0.94	8,3	0.33	14,2	0.56
FJ3243-0505S	-05	1/2-20	45,5	1.79	25,1	0.99	9,1	0.36	15,8	0.62
FJ3243-0808S	-08	3/4-16	58,4	2.30	40,2	1.58	14,0	0.55	22,4	0.88
FJ3243-0810S	-10	3/4-16	61,5	2.42	39,1	1.54	14,0	0.55	22,4	0.88
FJ3243-1010S	-10	7/8-14	63,5	2.50	41,1	1.62	16,0	0.63	25,4	1.00
FJ3246 - SAE 45° swivel-										
FJ3246-0606S	-06	5/8-18	49,3	1.94	29,2	1.15	9,9	0.39	19,1	0.75
FJ3246-1212S	-12	1 1/16-14	71,7	2.82	49,3	1.94	19,7	0.77	31,8	1.25
FJ3249 - SAE 37° (JIC) swivel-										
FJ3249-0606S	-06	9/16-18	49,3	1.94	29,2	1.15	9,9	0.39	17,5	0.69
FJ3249-0608S	-08	9/16-18	49,8	1.96	29,2	1.15	9,9	0.39	17,5	0.69
FJ3249-1212S	-12	1 1/16-12	71,7	2.82	49,3	1.94	19,7	0.77	31,8	1.25
FJ3249-1616S	-16	1 5/16-12	85,7	3.38	60,7	2.39	27,1	1.07	38,1	1.50
FJ3249-2020S	-20	1 5/8-12	100,7	3.96	65,9	2.59	31,0	1.22	50,8	2.00

90° elbow

FJ3244 - Universal swivel

FJ3247 - SAE 45° swivel

FJ3250 - SAE 37° (JIC) swivel

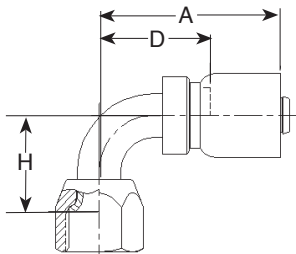

Complete fitting part #	Hose size	Thread	A		D		H		HEX	
			mm	in	mm	in	mm	in	mm	in
FJ3244 universal swivel-										
FJ3244-0404S	-04	7/16-20	40,9	1.61	21,1	0.83	17,3	0.68	14,2	0.56
FJ3244-0405S	-05	7/16-20	41,2	1.62	21,1	0.83	17,3	0.68	14,2	0.56
FJ3244-0505S	-05	1/2-20	42,7	1.68	22,5	0.89	19,5	0.77	15,8	0.62
FJ3244-0808S	-08	3/4-16	52,6	2.07	32,3	1.27	27,7	1.09	22,4	0.88
FJ3244-0810S	-10	3/4-16	55,1	2.17	32,9	1.29	27,7	1.09	22,4	0.88
FJ3244-1010S	-10	7/8-14	63,7	2.51	41,4	1.63	31,2	1.23	25,4	1.00
FJ3244-1012S	-12	7/8-14	66,1	2.60	43,4	1.71	31,2	1.23	25,4	1.00
FJ3247 - SAE 45° swivel-										
FJ3247-0606S	-06	5/8-18	46,6	1.84	26,7	1.05	21,6	0.85	19,1	0.75
FJ3247-1212S	-12	1 1/16-14	70,6	2.78	48,3	1.90	46,2	1.82	31,8	1.25
FJ3250 - SAE 37° (JIC) swivel-										
FJ3250-0604S	-04	9/16-18	46,5	1.83	26,7	1.05	21,6	0.85	17,5	0.69
FJ3250-0606S	-06	9/16-18	46,7	1.84	26,7	1.05	21,6	0.85	17,5	0.69
FJ3250-0608S	-08	9/16-18	47,0	1.85	26,7	1.05	21,6	0.85	17,5	0.69
FJ3250-1212S	-12	1 1/16-12	70,6	2.78	48,3	1.90	46,2	1.82	31,8	1.25
FJ3250-1216S	-16	1 1/16-12	74,7	2.94	49,5	1.95	46,2	1.82	31,8	1.25
FJ3250-1616S	-16	1 5/16-12	80,9	3.19	55,9	2.20	60,8	2.39	38,1	1.50
FJ3250-2020S	-20	1 5/8-12	108,5	4.27	73,7	2.90	82,6	3.25	50,8	2.00
FJ3250-2424S	-24	1 7/8-12	108,5	4.27	70,8	2.79	77,5	3.05	57,2	2.25

* Pictures may not represent actual configuration. Call Eaton Technical Assistance for details.

Crimp fittings

Truck and fuel 100R5
(FJ Series)

H

100R5 crimp fittings

90° (long drop) elbow, SAE, JIC and universal swivel

FJ3245-Universal swivel

FJ3248- SAE 45

FJ3251-SAE 37

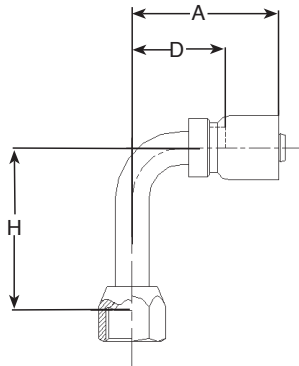

For use with hose: 1503, FC234, FC300, FC350, FC355

Complete fitting part #	Hose size	Thread size	A		D		H		HEX	
			mm	in	mm	in	mm	in	mm	in
FJ3245-Universal swivel										
FJ3245-0404S	-04	7/16 - 20	40,9	1.61	21,1	0.83	45,7	1.80	14,2	0.56
FJ3245-0505S	-05	1/2 - 20	42,8	1.68	22,7	0.89	45,0	1.77	15,9	0.63
FJ3245-0808S	-08	3/4 - 16	55,6	2.19	35,4	1.39	61,7	2.43	22,4	0.88
FJ3245-0810S	-10	3/4 - 16	58,4	2.30	36,0	1.42	61,7	2.43	22,4	0.88
FJ3245-1010S	-10	7/8 - 14	62,4	2.46	40,0	1.57	65,3	2.57	25,4	1.00
FJ3248- SAE 45										
FJ3248-0606S	-06	5/8 - 18	46,8	1.84	26,7	1.05	55,3	2.18	19,1	0.75
FJ3248-1212S	-12	1 1/16 - 14	70,6	2.78	48,3	1.90	94,7	3.73	31,8	1.25
FJ3251-SAE 37										
FJ3251-0606S	-06	9/16 - 18	46,8	1.84	26,7	1.05	55,3	2.18	17,5	0.69
FJ3251-1212S	-12	1 1/16 - 12	70,6	2.78	48,3	1.90	94,7	3.73	31,8	1.25
FJ3251-1616S	-16	1 5/16 - 12	80,9	3.19	55,9	2.20	116,4	4.58	38,1	1.50

Male pipe

FJ3152-

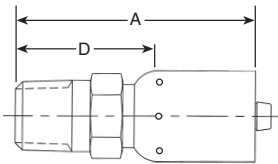

Complete fitting part #	Hose size	Thread	A		D	
			mm	in	mm	in
FJ3152-						
FJ3152-0204S	-04	1/8-27	45,3	1.78	25,5	1.00
FJ3152-0404S	-04	1/4-18	46,9	1.85	27,0	1.06
FJ3152-0405S	-05	1/4-18	47,8	1.88	23,6	0.93
FJ3152-0406S	-06	1/4-18	47,1	1.85	27,0	1.06
FJ3152-0606S	-06	3/8-18	47,1	1.85	27,0	1.06
FJ3152-0608S	-08	3/8-18	51,8	2.04	24,9	0.98
FJ3152-0808S	-08	1/2-14	54,6	2.15	34,4	1.35
FJ3152-0810S	-10	1/2-14	56,9	2.24	34,5	1.36
FJ3152-0812S	-12	1/2-14	6,39	2.52	32,0	1.26
FJ3152-1210S	-10	3/4-14	62,7	2.47	35,1	1.38
FJ3152-1212S	-12	3/4-14	56,9	2.24	34,5	1.36
FJ3152-1216S	-16	3/4-14	68,3	2.69	35,6	1.40
FJ3152-1616S	-16	1-11 1/2	66,3	2.61	41,3	1.63
FJ3152-2020S	-20	1 1/4 -11 1/2	75,7	2.98	45,6	1.79
FJ3152-2424S	-24	1 1/2-11 1/2	85,9	3.38	48,2	1.90
FJ3152-3232S	-32	2-11 1/2	104,3	4.11	55,6	2.19

* Pictures may not represent actual configuration. Call Eaton Technical Assistance for details.

100R5 crimp fittings

For use with hose: 1503, FC234, FC300, FC350, FC355

MALE pipe swivel - MTO

EJ3998-

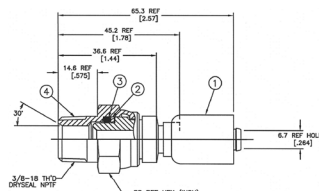

Complete fitting part #	Hose size	Thread	A		D		HEX	
			mm	in	mm	in	mm	in
EJ3998*								
EJ3998-0606S	-06	3/8-18	68,1	2.68	36,6	1.44	22,4	0.88
EJ3998-0608S	-08	3/8-18	65,3	2.57	38,8	1.44	22,4	0.88

* MTO (Made to order)

Straight male 37° flare - Rigid

EJ7537-

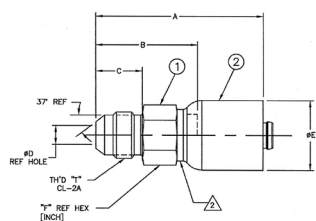

Complete fitting part #	Hose size	Thread	A		D		HEX	
			mm	in	mm	in	mm	in
EJ7537								
EJ7537-1212S	-12	1 1/16-12	66,0	2.60	43,7	1.72	28,6	1.13

ORS swivel straight

FJ3468-

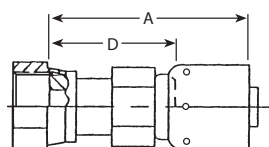

Complete fitting part #	Hose size	Thread	A		D		HEX	
			mm	in	mm	in	mm	in
FJ3468-								
FJ3468-0404S	-04	9/16-18	46,6	1.83	26,8	1.05	17,5	0.69
FJ3468-0405S	-05	9/16-18	48,4	1.91	28,3	1.12	17,5	0.69
FJ3468-0605S	-05	11/16-16	50,7	1.99	30,6	1.21	20,6	0.81
FJ3468-0805S	-05	13/16-16	54,7	2.15	34,6	1.36	23,9	0.94
FJ3468-0606S	-06	11/16-16	50,7	1.99	30,6	1.21	20,6	0.81
FJ3468-0806S	-06	13/16-16	54,7	2.15	34,6	1.36	23,9	0.94
FJ3468-0608S	-08	11/16-16	52,6	2.07	32,4	1.28	20,6	0.81
FJ3468-0808S	-08	13/16-16	54,8	2.16	34,6	1.38	23,9	0.94
FJ3468-0810S	-10	13/16-16	57,1	2.25	34,7	1.37	23,9	0.94
FJ3468-1010S	-10	1-14	59,6	2.34	37,2	1.46	28,6	1.13
FJ3468-1210S	-10	1 3/16-12	63,6	2.50	41,2	1.62	34,9	1.38
FJ3468-1212S	-12	1 3/16-12	63,6	2.50	41,2	1.62	34,9	1.38
FJ3468-1216S	-16	1 3/16-12	72,3	2.85	47,3	1.86	34,9	1.38
FJ3468-1616S	-16	1 7/16-12	71,7	2.80	46,1	1.82	41,3	1.63
FJ3468-1620S	-20	1 7/16-12	76,7	3.02	46,5	1.83	41,3	1.63
FJ3468-2020S	-20	1 11/16-12	78,7	3.10	48,6	1.91	47,6	1.88
FJ3468-2424S	-24	2-12	89,6	3.53	51,9	2.04	57,2	2.25

Crimp fittings

Truck and fuel 100R5
(FJ Series)

H

100R5 crimp fittings

For use with hose: 1503, FC234, FC300, FC350, FC355

ORS swivel 45° elbow FJ3254-

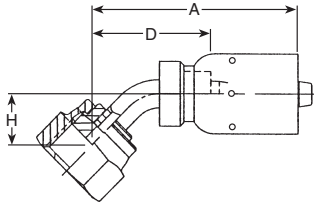

Complete fitting part #	Hose size	Thread	A		D		H		HEX	
			mm	in	mm	in	mm	in	mm	in
FJ3254-										
FJ3254-0404S	-04	9/16-18	46,5	1.83	26,7	1.05	11,2	0.44	17,5	0.69
FJ3254-0405S	-05	9/16-18	47,0	1.85	27,2	1.07	8,3	0.33	17,5	0.69
FJ3254-0406S*	-06	9/16-18	47,6	1.87	27,5	1.08	11,4	0.45	17,5	0.69
FJ3254-0606S	-06	11/16-16	50,6	1.99	30,2	1.19	11,2	0.44	20,6	0.81
FJ3254-0808S	-08	13/16-16	59,4	2.34	39,1	1.54	15,0	0.59	23,9	0.94
FJ3254-0810s	-10	13/16-16	62,2	2.45	39,9	1.57	15,0	0.59	23,9	0.94
FJ3254-1010S	-10	1-14	67,3	2.65	45,1	1.77	17,6	0.69	28,6	1.13
FJ3254-1210S	-10	1 3/16-12	74,0	2.91	51,6	2.03	21,6	0.85	34,9	1.38
FJ3254-1212S	-12	1 3/16-12	73,2	2.88	50,8	1.99	21,1	0.83	34,9	1.38
FJ3254-1216S*	-16	1 3/16-12	80,5	3.17	52,6	2.07	21,4	0.84	34,9	1.38
FJ3254-1616S	-16	1 7/16-12	82,7	3.25	57,7	2.27	24,1	0.95	41,3	1.63

*MTO (Made to order)

ORS swivel 90° elbow FJ3255-

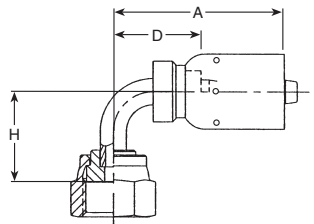

Complete fitting part #	Hose size	Thread	A		D		H		HEX	
			mm	in	mm	in	mm	in	mm	in
FJ3255-										
FJ3255-0404S	-04	9/16-18	40,9	1.61	21,1	0.83	21,4	0.84	17,5	0.69
FJ3255-0405S	-05	9/16-18	44,3	1.74	21,4	0.84	21,7	0.85	17,5	0.69
FJ3255-0605S	-05	11/16-16	46,7	1.84	26,7	1.05	23,1	0.91	20,6	0.81
FJ3255-0406S	-06	9/16-18	43,6	1.72	23,6	0.93	21,4	0.84	17,5	0.69
FJ3255-0606S	-06	11/16-16	46,7	1.84	26,7	1.05	23,1	0.91	20,6	0.81
FJ3255-0806S	-06	11/16-16	52,3	2.06	32,3	1.27	29,2	1.15	23,9	0.94
FJ3255-0608S	-08	11/16-16	47,2	1.86	27,1	1.07	23,9	0.94	20,6	0.81
FJ3255-0808S	-08	13/16-16	52,5	2.07	32,3	1.27	29,2	1.15	23,9	0.94
FJ3255-0810S	-10	13/16-16	55,4	2.18	33,1	1.30	29,7	1.17	23,9	0.94
FJ3255-1010S	-10	1-14	58,4	2.30	36,1	1.42	33,3	1.31	28,6	1.13
FJ3255-1210S	-10	1 3/16-12	71,0	2.80	48,6	1.91	48,9	1.93	34,9	1.38
FJ3255-1212S	-12	1 3/16-12	70,6	2.78	48,3	1.90	48,3	1.90	34,9	1.38
FJ3255-1616S	-16	1 7/16-12	81,0	3.19	55,9	2.20	56,4	2.22	41,3	1.63
FJ3255-2020S	-20	1 11/16-12	92,7	3.65	62,7	2.47	63,4	2.50	47,6	1.88

ORS swivel straight, metric hex EJ3932-

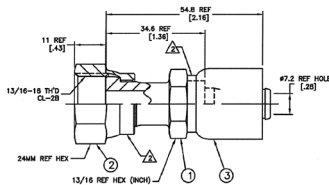

Complete fitting part #	Hose size	Thread	A		D		HEX	
			mm	in	mm	in	mm	in
EJ3932-								
EJ3932-0606S	-06	11/16-16	50,8	2.00	30,7	1.21	22	0.87
EJ3932-0808S	-08	13/16-16	54,8	2.16	34,6	1.36	24	0.94
EJ3932-1010S	-10	1-14	59,6	2.35	37,2	1.49	30	1.18
EJ3932-1212S	-12	1 3/16-12	63,6	2.50	41,2	1.62	30	1.18

100R5 crimp fittings

For use with hose: 1503, FC234, FC300, FC350, FC355

ORS swivel 90° elbow, long drop

EJ5041-

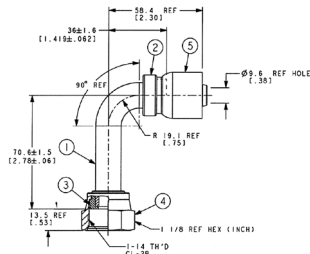

Complete fitting part #	Hose size	Thread	A		D		H		HEX	
			mm	in	mm	in	mm	in	mm	in
EJ5041-										
EJ5041-0606S	-06	11/16-16	50,3	1.98	30,2	1.98	54,4	2.10	20,6	0.81
EJ5041-1010S	-10	1-14	58,4	2.30	36,0	1.42	70,6	2.78	28,6	1.13
EJ5041-1616S*	-16	1 7/16-12	80,9	3.19	55,9	2.20	114,25	4.50	41,3	1.63

*MTO (Made to order)

Male ORS swivel - straight

EJ7257-

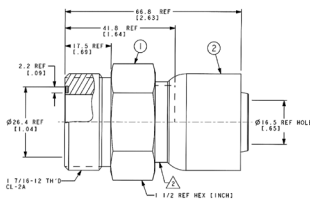

Complete fitting part #	Hose size	Thread	A		D		①	
			mm	in	mm	in	mm	in
EJ7257-								
EJ7257-1616S	-16	1 7/16-12	66,8	2.63	24,3	0.95	38,1	1.5

LifeSaver braze on hose end

EJ5611

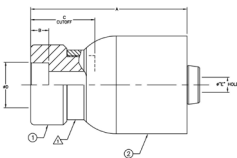

Complete fitting part #	Tube Size*	Hose size	A		D	
			mm	in	mm	in
EJ5611						
EJ5611-0606S	9,5 0.38	-6	34,1	1.34	14,0	0.55
EJ5611-0608S	9,5 0.38	-8	34,2	1.35	14,0	0.55
EJ5611-0808S	12,7 0.50	-8	34,2	1.35	14,0	0.55
EJ5611-0810S	12,7 0.50	-10	37,0	1.46	14,6	0.57
EJ5611-1010S	16,0 0.63	-10	37,0	1.46	14,6	0.57
EJ5611-1212S	19,1 0.75	-12	38,9	1.53	16,5	0.65
EJ5611-1616S	25,4 1.00	-16	42,8	1.69	17,8	0.70

*Counterbore Diameter for mating Tube

BSP 30° female swivel - MTO

EJ3619-

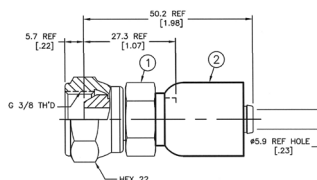

Complete fitting part #	Hose size	Thread	A		D		①	
			mm	in	mm	in	mm	in
EJ3619*								
EJ3619-0404S	-04	1/4-19	46,9	1.85	24,0	0.95	17,0	0.67
EJ3619-0606S	-06	3/8-19	50,2	1.98	27,3	1.07	22,0	0.87
EJ3619-0806S	-06	1/2-14	51,7	2.04	28,8	1.13	27,0	1.06
EJ3619-0808S	-08	1/2-14	59,0	2.32	36,1	1.42	27,0	1.06
EJ3619-1212S	-12	3/4-14	65,1	2.56	39,8	1.57	32,0	1.26
EJ3619-1616S	-16	1-11	64,4	2.54	36,5	1.44	41,0	1.61

*MTO (Made to order)

Crimp fittings

Truck and fuel 100R5
(FJ Series)

H

100R5 crimp fittings

For use with hose: 1503, FC234, FC300, FC350, FC355

Split flange straight (Code 61)

FJ3549-

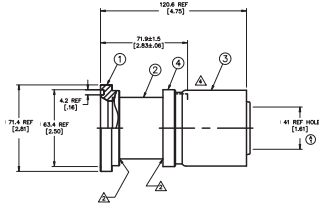

Complete fitting part #	Hose size	A		D	
		mm	in	mm	in
FJ3549-					
FJ3549-3232S	-32	120,6	4.75	71,9	2.83

Split flange 30° (Code 61)

FJ3550-

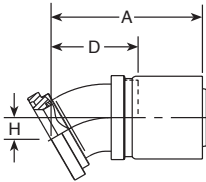

Complete fitting part #	Hose size	A		D		H	
		mm	in	mm	in	mm	in
FJ3550-*							
FJ3550-3232S	-32	114,5	4.51	65,7	2.59	16,4	0.64

*MTO Requires use of Split Die Cage, FT1392-200-R5-32

Split flange 45° (Code 61)

FJ3551-

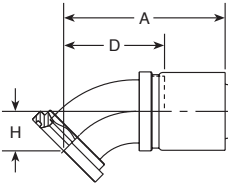

Complete fitting part #	Hose size	A		D		H	
		mm	in	mm	in	mm	in
FJ3551-*							
FJ3551-3232S	-32	129,8	5.11	81,0	3.19	31,8	1.25

*MTO Requires use of Split Die Cage, FT1392-200-R5-32

Split flange 60° (Code 61)

FJ3566-

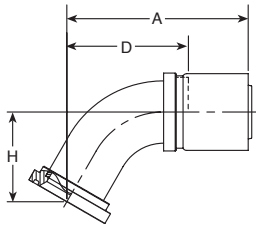

Complete fitting part #	Hose size	A		D		H	
		mm	in	mm	in	mm	in
FJ3566-*							
FJ3566-3232S	-32	148,1	5.83	99,3	3.91	73,2	2.88

*MTO Requires use of Split Die Cage, FT1392-200-R5-32

Split flange 90° (Code 61)

FJ3552-

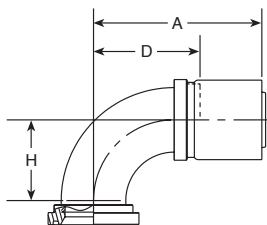

Complete fitting part #	Hose size	A		D		H	
		mm	in	mm	in	mm	in
FJ3552-							
FJ3552-2020S	-20	101,9	4.01	61,3	2.41	63,5	2.50
FJ3552-2424S	-24	105,3	4.14	67,6	2.66	69,8	2.75
FJ3552-3232S	-32	148,1	5.83	99,3	3.91	73,2	2.88

Split flanges

Split flanges

Eaton has standard pressure series (code 61) and high pressure series (code 62) split flange components in kit form that save time in selecting and ordering. Each kit includes two flange halves, four grade-8 hex bolts, four lock washers and an O-Ring. The standard kit has a Buna-N 90 durometer O-Ring that is compatible with petroleum and water-base hydraulic fluids. Optional kits contain EPDM and Viton* O-Ring for applications where fluid compatibility or high temperatures require other than Buna-N O-Ring.

*Viton is a trademark of The Chemours Company FC, LLC

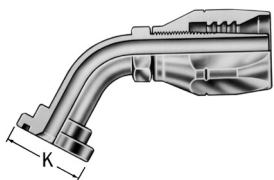

Two methods can be used to determine the flange dash size and code. The first is by measuring the flange head diameter on the fitting itself. This is referred to as the "K" dimension. The second is by measuring the "A" dimension on the flange or the flange port. Either will determine the dash size and the code since these dimensions are exclusive to either code 61 or code 62 split flange kits. See chart below for these dimensions.

In some cases, split flange fittings are available for hoses which exceed the pressures listed; when ordering fittings or hose assemblies, the terminal end performance rating may reduce the overall rating of the assembly.

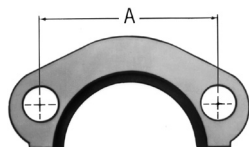

"A" Dim.	"K" Flange head diameter	Flange dash size	Maximum operating pressure*		Recommended bolt torque
			in	psi	
in	in	mm	bar	psi	lb-in
Code 61					
1.50	1.19	-08	350,0	5000	175-225
1.88	1.50	-12	350,0	5000	225-350
2.06	1.75	-16	350,0	5000	325-425
2.31	2.00	-20	280,0	4000	425-550
2.75	2.38	-24	210,0	3000	550-700
3.06	2.81	-32	210,0	3000	650-800
3.50	3.31	-40	175,0	2500	950-1100
4.19	4.00	-48	140,0	2000	1650-1800
Code 62					
1.59	1.25	-08	420,0	6000	175-225
2.00	1.63	-12	420,0	6000	300-400
2.25	1.88	-16	420,0	6000	500-600
2.62	2.12	-20	420,0	6000	750-900
3.12	2.50	-24	420,0	6000	1400-1600
3.81	3.12	-32	420,0	6000	2400-2600

*Per SAE J518 standard.

Assembly procedure

Many leakage problems can be avoided if the split flanges are properly assembled.

To properly assemble

1. Clean all mating surfaces.
2. Lubricate the O-Ring.
3. Partially tighten each bolt in rotation until all are fully tightened to the recommended torque value.

How to order

1. Determine the dash size and the code.
2. Select O-Ring for fluid compatibility.
3. Order by kit number shown on pages H-88 to H-89.

Crimp fittings

Split flange kits

H

Split flange kits

SAE standard pressure series (Code 61) SAE J518

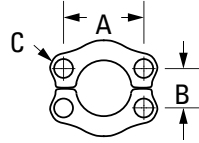
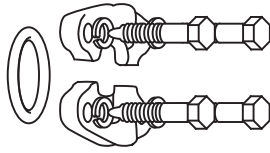

O-Rings material:
Buna-N 90 Durometer
Temperature range:
-40°F to +250°F
(-40°C to + 121°C)

Nominal flange size	Complete kit	*Flange halves 2 required	*Buna-N O-Ring 1 required	*Bolts 4 required	*Lock washer 4 required	A	B	C	Bolt torque lb.-in
1/2	FF593-08	449-74446-8	FF9446-210	FF9442-0520-94	210104-5S	1.50	0.68	0.34	175-225
3/4	FF593-12	449-74446-12	FF9446-214	FF9442-0620-94	210104-6S	1.88	0.88	0.41	250-350
1	FF593-16	449-74446-16	FF9446-219	FF9442-0620-94	210104-2-6S	2.06	1.04	0.41	325-425
1-1/4	FF593-20	449-74446-20	FF9446-222	FF9442-0724-94	210104-7S	2.31	1.18	0.48	425-550
1-1/2	FF593-24	449-74446-24	FF9446-225	FF9442-0824-94	210104-8S	2.75	1.40	0.53	550-700
2	FF593-32	449-74446-32	FF9446-228	FF9442-0824-94	210104-8S	3.06	1.68	0.53	650-800
2-1/2	FF593-40	449-74446-40	FF9446-232	FF9442-0828-94	210104-8S	3.50	2.00	0.53	950-1100
3	FF593-48	449-74446-48	FF9446-237	FF9442-1028-94	210104-10S	4.19	2.44	0.66	1650-1800

* Included in kit.

*Viton kit available as part # FF687-Size. EPDM kit available as part # FF688-size. See pg. H-89 for Viton and EPDM O-Ring part numbers.

Note: All measurements in inches.

SAE high pressure series (Code 62) SAE J518

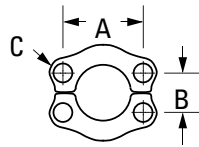
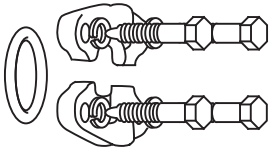

O-Ring material:
Buna-N 90 Durometer
Temperature range:
-40°F to +250°F
(-40°C to + 121°C)

Note: Code 62 split flange kits cannot be used with Cat flange fittings. Use existing split flanges.

Nominal flange size	Complete kit	*Flange halves 2 required	*Buna-N O-Ring 1 required	*Bolts 4 required	*Lock washer 4 required	A	B	C	Bolt torque lb.-in
3/4	FF595-12	FC3425-12-449	FF9446-214	FF9442-0624-94	210104-6S	2.00	0.94	0.42	300-400
1	FF595-16	FC3425-16-449	FF9446-219	FF9442-0728-94	210104-7S	2.25	1.10	0.50	500-600
1-1/4	FF595-20	FC3425-20-449	FF9446-222	FF9442-0828-94	210104-8S	2.62	1.24	0.60	750-900
1-1/2	FF595-24	FC3425-24-449	FF9446-225	FF9442-1036-94	210104-10S	3.12	1.44	0.66	1400-1600
2	FF595-32	FC3425-32-449	FF9446-228	FF9442-1244-94	210104-12S	3.81	1.76	0.78	2400-2600

* Included in kit.

* Viton kit available as part #FF689-size. See page H-89 for Viton O-Ring part numbers.

Note: All measurements in inches.

Viton is a trademark of The Chemours Company FC, LLC

Split flange kits

4 hole flange
SAE standard pressure series
(Code 61) SAE J518

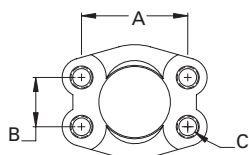

Nominal flange size	4 bolt flange	A	B	C (Threaded)
3/4	FC2119-12-449	1.88	0.88	3/8-16
1	FC2119-16-449	2.06	1.03	7/16-14
1-1/4	FC2119-20-449	2.31	1.19	3/8-16
1-1/2	FC2119-24-449	2.75	1.41	1/2-13
2	FC2119-32-449	3.06	1.69	1/2-13
2-1/2	FC2119-40-449	3.50	2.00	1/2-13

*Available without threads as part #FC3459-size-449.

Note: All measurements in inches.

O-Ring for SAE J518
Split flange

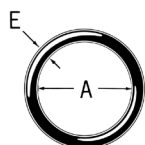

O-Ring base number	Material	Operating temperature range
FF9016 EPDM	80 Durometer	-65°F to +300°F (-55°C to +150°C)
FF9446 Buna-N	90 Durometer Buna-N	-40°F to +250°F (-40°C to +121°C)
22046 Viton	90 Durometer	-15°F to +400°F (-25°C to +205°C)

Available without threads part #FC3459-size-449.

O-Ring dash size designation	Flange dash size	Nominal flange size	A		E	
			mm	in	mm	in
-210	08	1/2	18,5	0.734	3,5	0.139
-214	12	3/4	24,9	0.984	3,5	0.139
-219	16	1	32,9	1.296	3,5	0.139
-222	20	1 1/4	37,7	1.484	3,5	0.139
-225	24	1 1/2	47,2	1.859	3,5	0.139
-228	32	2	56,7	2.234	3,5	0.139
-232	40	2 1/2	69,4	2.734	3,5	0.139
-237	48	3	85,3	3.359	3,5	0.139

Viton is a trademark of The Chemours Company FC, LLC

Crimp fittings

O-Rings and kits

H

O-Rings

Cat flange D-Ring*

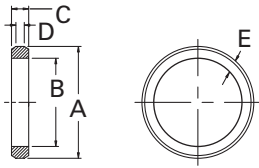

Part number	A		B		C		D		E	
	mm	in	mm	in	mm	in	mm	in	mm	in
FF90319-12	32,3	1.27	25,4	1.00	5,1	0.20	2,5	0.10	3,6	0.14
FF90319-16	38,6	1.52	31,8	1.25	5,1	0.20	2,5	0.10	3,6	0.14
FF90319-20	45,0	1.77	38,1	1.50	5,1	0.20	2,5	0.10	3,6	0.14
FF90319-24	51,6	2.03	44,7	1.76	5,1	0.20	2,5	0.10	3,6	0.14
FF90319-32	70,6	2.78	64,0	2.52	5,1	0.20	2,5	0.10	3,6	0.14

Temperature range: -40°F to +212°F

Material: Nitrile (Buna-N).

*To be used only with Cat flange.

O-Rings for bump tube O-Ring seal and O-Ring pilot fitting

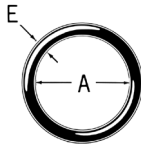

Part number	O-Ring pilot dash size	A		E	
		mm	in	mm	in
22546-11	-06	7,6	0.30	1,8	0.07
22546-13	-08	10,9	0.43	1,8	0.07
22546-15	-10	14,0	0.55	1,8	0.07
22546-17	-12	17,3	0.68	1,8	0.07

O-Ring seal kit FF16087-01

Includes: metal box,
O-Rings for ORS -4 through -24,
O-Ring boss -04 through -32,
Split flange -08 through -32,
24 packages with twelve
90 durometer nitrile
O-Ring per package.
Replacement O-Ring can be
ordered individually by
part number listed.



FF16087-01

Connection	Size	Individual O-Ring part no.
ORS	-04	FF9446-11
ORS	-06	FF9446-12
ORS	-08	FF9446-14
ORS	-10	FF9446-16
ORS	-12	FF9446-18
ORS	-16	FF9446-21
ORS	-20	FF9446-25
ORS	-24	FF9446-29
O-Ring Boss	-04	22617-4
O-Ring Boss	-05	22617-5
O-Ring Boss	-06	22617-6
O-Ring Boss	-08	22617-8
O-Ring Boss	-10	22617-10
O-Ring Boss	-12	22617-12
O-Ring Boss	-16	22617-16
O-Ring Boss	-20	22617-20
O-Ring Boss	-24	22617-24
O-Ring Boss	-32	22617-32
Split Flange	-08	FF9446-210
Split Flange	-12	FF9446-214
Split Flange	-16	FF9446-219
Split Flange	-20	FF9446-222
Split Flange	-24	FF9446-225
Split Flange	-32	FF9446-228

BSPP bonded seal for DIN 3852-2 ports

FF9895

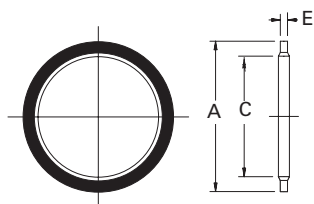

Bonded seal part number	BSPP thread size	A Ref	C Ref	E Ref
		inch	inch	inch
FF9895-02	1/8-28	0.625	0.403	0.080
FF9895-04	1/4-19	0.810	0.536	0.080
FF9895-06	3/8-19	0.937	0.675	0.080
FF9895-08	1/2-14	1.125	0.843	0.097
FF9895-10	5/8-14	1.250	0.920	0.097
FF9895-12	3/4-14	1.375	1.060	0.097
FF9895-16	1-11	1.685	1.329	0.133
FF9895-20	1 1/4-11	2.062	1.685	0.133
FF9895-24	1 1/2-11	2.307	1.902	0.133
FF9895-32	2-11	2.875	2.380	0.133

Material: Steel with bonded Nitrile (Buna-N) seal.

Crimp fittings

O-Rings and kits

H

Designating separate SAE O-Ring boss

To order Eaton O-Ring separately without fittings specify the size and material by using the O-Ring base number and dash size. The charts offer a simple method to assure the correct O-Ring for your application.

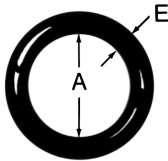

O-Ring base no.	Material	Operating temperature range
22617 (Standard)	Buna-N Nitrile rubber 90 Durometer	-30°F to +250°F (-34°C to +121°C)
22033	EPDM Ethylene propylene diene monomer	-65°F to +212°F (-55°C to +100°C)
22068	Viton Fluoroelastomer 90 Durometer	-15°F to +400°F (-25°C to +205°C)
22012	Buna-N, Low temperature nitrile rubber 90 Durometer	-65°F to +225°F (-55°C to +107°C)

O-Ring dash size	Tube size	A		E	
		mm	in	mm	in
-4	-04 (1/4)	8,9	0.351	1,8	0.072
-6	-06 (3/8)	11,9	0.468	2,0	0.078
-8	-08 (1/2)	16,3	0.644	2,3	0.087
-10	-10 (5/8)	19,3	0.755	2,5	0.097
-12	-12 (3/4)	23,4	0.924	3,0	0.116
-16	-16 (1)	29,7	1.171	3,0	0.116
-20	-20 (1 1/4)	37,6	1.475	3,0	0.118
-24	-24 (1 1/2)	43,7	1.720	3,0	0.118

Designating separate ORS O-Ring

To order Eaton O-Ring separately without fittings specify the size and material by using the O-Ring designator and O-Ring base number. The charts to the right offer a simple method to assure the correct O-Ring for your application.

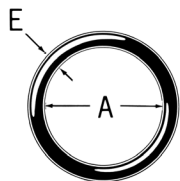

O-Ring base no.	Material	Operating temperature range
FF9446 (Standard)	Buna-N Nitrile Rubber 90 Durometer	-40°F to +250°F (-40°C to +121°C)
FF9807	EPDM Ethylene propylene diene monomer	-65°F to +300°F (-55°C to +150°C)
22046	Viton Fluoroelastomer 90 Durometer	-15°F to +400°F (-25°C to +205°C)
FF9855	Buna-N, Low Temperature Nitrile Rubber 90 Durometer	-65°F to +225°F (-55°C to +107°C)
22546	Neoprene 90 Durometer	-65°F to +300°F (-55°C to +150°C)

O-Ring dash size	Tube size	A		E	
		mm	in	mm	in
-11	-04	7,6	0.301	1,8	0.07
-12	-06	9,2	0.364	1,8	0.07
-14	-08	12,4	0.489	1,8	0.07
-16	-10	15,6	0.614	1,8	0.07
-18	-12	18,8	0.739	1,8	0.07
-21	-16	23,5	0.926	1,8	0.07
-25	-20	29,9	1.176	1,8	0.07
-29	-24	37,8	1.489	1,8	0.07

Viton is a trademark of The Chemours Company FC, LLC

Hose fittings – Reusable

How to order	I-2	SOCKETLESS	I-48
Socket data	I-3	Specialty hose	
SAE 100R5 style	I-4	Power steering and air brake	I-54
Braided hydraulic – one-wire	I-17	Railroad air brake	I-56
100R1 TTC		PTFE hose	
Braided hydraulic – two-wire	I-20	“Super Gem”	I-57
Hi-Pac fittings		Split flange kits	I-61
100R2 skive style	I-26	O-Rings and kits	I-64
100R2 TTC	I-38		
Spiral hose	I-41		



Hose fittings – Reusable

How to order

How to order

Accurate processing and prompt delivery of your order depend on easy identification of your requirements. Please order Eaton parts using correct part numbers as described in this catalog. Inquiries and orders should be directed to your Aeroquip Distributor or:

Eaton Hydraulics
14615 Lone Oak Road
Eden Prairie, MN 55344
952-937-9800;
888-258-0222;
Fax: 952-974-7722
www.eaton.com/hydraulics

Part numbers and Dash sizes

Dash size designates the nominal size in 16ths of an inch. This number immediately follows the part number and is separated from it with a dash.

Fittings with “FC” or “FJ” part numbers will have the size expressed in four numerals. The first two numerals indicate the size of the connecting end and the second two numerals indicate the size of the hose end. All other fittings are followed by a dash number which is the nominal size of the fitting expressed in 16ths of an inch. Where two dash numbers are given, the first one generally indicates the pipe or port size and the second indicates the tube or hose size. The hose dash number should always be the same as the last dash number on the fitting.

Reusable fittings

Fittings are ordered as complete assemblies.

Complete number: **412- 8 10 S**
Basic part number _____
Pipe or port size (in 16ths of an inch) _____
Mating hose size _____
Material designation suffix _____

Material Designation

Most fittings in this catalog have a material designation as part of the part number. An explanation is shown below.

Prefix Designations

- 38 Brass nipple, steel socket
- 44 Bronze nipple and nut: brass socket
- 63 Brass nipple, steel nut and socket
- 259 316 Stainless steel
- 449 Malleable iron

Suffix Designations

- B Brass
- C Stainless steel
- D Aluminum alloy
- S Steel

Dimensions

Dimensions given in this catalog for Eaton brand products are approximate and should be used for reference only. Exact dimensional information for a given product is subject to change and varying tolerances; contact Eaton directly for full current information.

Globally standardized pressure ratings

Eaton has standardized hose burst and operating pressure ratings in cataloging, worldwide. This move toward standardization will slightly alter some of the pressures ratings listed for hoses in this catalog as pressures are rounded off. This is a paper conversion only. This action has no effect on the actual testing and certification of Eaton hoses to stringent product standards.

Warning

Eaton manufactures the terminal ends of our hose fittings to the appropriate requirements established by the SAE. Therefore, the performance ratings of these hose fittings meet the SAE requirements. It is possible to order a hose assembly with a fitting terminal end that has a performance rating lower than the hose rating. When ordering hose assemblies, please keep the terminal end performance rating in mind since this may affect overall hose assembly performance.

Many hose assembly components (hose and fittings) are easily assembled in the field. However, factory assembled swaged, crimped and reusable hose assemblies are available. For complete information, contact Eaton.

Mixing/Matching

EATON FITTING TOLERANCES ARE ENGINEERED TO MATCH AEROQUIP HOSE TOLERANCES. THE USE OF EATON FITTINGS ON HOSE SUPPLIED BY OTHER MANUFACTURERS AND/OR THE USE OF AEROQUIP HOSE WITH FITTINGS SUPPLIED BY OTHER MANUFACTURERS' BRANDS MAY RESULT IN THE PRODUCTION OF UNRELIABLE AND UNSAFE HOSE ASSEMBLIES AND IS NEITHER RECOMMENDED NOR AUTHORIZED BY EATON.

EATON SHALL NOT BE SUBJECT TO AND DISCLAIMS ANY OBLIGATIONS OR LIABILITIES (INCLUDING BUT NOT LIMITED TO ALL CONSEQUENTIAL, INCIDENTAL AND CONTINGENT DAMAGES) ARISING OUT OF BREACH OF CONTACT OR OF WARRANTY OR ARISING FROM TORT CLAIMS (INCLUDING WITHOUT LIMITATION NEGLIGENCE AND STRICT LIABILITY) OR OTHER THEORIES OF LAW WITH RESPECT TO ANY HOSE ASSEMBLIES NOT PRODUCED FROM GENUINE EATON HOSE FITTINGS, HOSE AND EATON APPROVED EQUIPMENT, AND IN CONFORMANCE WITH EATON PROCESS AND PRODUCT INSTRUCTIONS FOR EACH SPECIFIC HOSE ASSEMBLY.

FAILURE TO FOLLOW EATON PROCESS AND PRODUCT INSTRUCTIONS AND LIMITATIONS COULD LEAD TO PREMATURE HOSE ASSEMBLY FAILURES RESULTING IN PROPERTY DAMAGE, SERIOUS INJURY OR DEATH.













Socket data

Socket to hose correction combinations

Use of the correct Eaton socket with a given Aeroquip hose is essential for proper assembly and performance.

Virtually all Eaton hose sockets are marked with the socket part number and dash size. Using this number, from the table below, the

correct hose or hoses may be found and dash sizes matched, to assure the correct combination.

Reusable sockets	Socket base part number	Aeroquip hose base part number	Dash sizes	Reusable sockets	Socket base part number	Aeroquip hose base part number	Dash sizes
	1206	2807, FC465 S-TW	all		4013	2781 FC195	-16 -16
	1208	2808	all		FC2383	GH493	-8, -16 -20, -24
	1210	303, 1503, 2580, 2651, FC234, FC300, FC321, FC350, FC355,	-4 to -12		FC2542	GH663	-04 to -16
	1212	302A, 1503, 1540, 2580, 2651, FC234, FC300, FC321, FC350, FC355,	-16 to -48		FC2642	FC310 FC510	all -04 to -16
	1214	2550, 2554, 2570	-6, -8		FC2652	GH793	-04 to -16
	1219	1531, 1531A	all				
	4007	GH493	-6, -12				
	4010	2781 FC195	-4 to -12 -20 to -32 -4 to -12 -20 to -32				

Hose fittings – Reusable

SAE 100R5 style

For use with hose:
1503, 2580, 2651, FC234,
FC300, FC321, FC350,
FC355, FC802

100R5 style

Male pipe

412-
44-412-

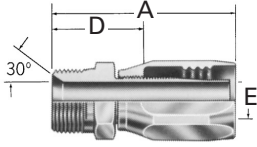

Dash size	Hose size	Thread	A		D		EØ	
			mm	in	mm	in	mm	in
412-								
†2-4S*	-04	1/8-27	42,7	1.68	23,4	.92	4,3	0.17
†4-4S*	-04	1/4-18	47,2	1.86	28,2	1.11	4,3	0.17
2-5S*	-05	1/8-27	45,2	1.78	25,4	1.00	5,8	0.23
†4-5S*	-05	1/4-18	49,8	1.96	30,0	1.18	5,8	0.23
†4-6S*	-06	1/4-18	54,1	2.13	31,2	1.23	7,6	0.30
†6-6S*	-06	3/8-18	54,1	2.13	31,2	1.23	6,1	0.24
†6-8S*	-08	3/8-18	63,0	2.48	33,8	1.33	9,9	0.39
†8-8S*	-08	1/2-14	69,3	2.73	40,1	1.58	9,1	0.36
†8-10S*	-10	1/2-14	73,2	2.88	40,4	1.59	12,2	0.48
12-10S*	-10	3/4-14	74,7	2.94	41,9	1.65	12,2	0.48
†12-12S*	-12	3/4-14	82,3	3.24	42,4	1.67	15,5	0.61
†12-16S	-16	3/4-14	71,1	2.80	38,9	1.53	20,8	0.82
†16-16S	-16	1-11 1/2	75,9	2.99	43,7	1.72	20,8	0.82
†16-20S	-20	-11 1/2	81,3	3.20	46,7	1.72	24,1	0.95
†20-20S	-20	1 1/4-11 1/2	82,0	3.23	47,5	1.87	26,7	1.05
†20-24S	-24	1 1/4-11 1/2	90,9	3.58	53,8	2.12	32,5	1.28
†24-24S	-24	1 1/2-11 1/2	88,4	3.48	51,6	2.03	32,5	1.28
†32-32S	-32	2-11 1/2	102,9	4.05	55,9	2.20	44,5	1.75
44-412-								
40-40	-40	2 1/2-8	127,8	5.03	79,5	3.13	53,8	2.12
48-48	-48	3-8	129,3	5.09	81,0	3.19	68,3	2.69

Male pipe

4412-

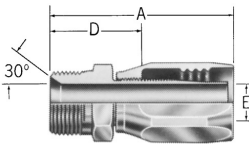

Dash size	Hose size	Thread	A		D		EØ	
			mm	in	mm	in	mm	in
4412-								
2-4S	-04	1/8-27	42,7	1.68	23,6	.93	3,3	0.13
4-4S	-04	1/4-18	47,5	1.87	28,4	1.12	3,3	0.13
4-5S	-05	1/4-18	49,8	1.96	30,0	1.18	4,3	0.17
4-6S†	-06	1/4-18	54,1	2.13	31,2	1.23	6,1	0.24
6-6S	-06	3/8-18	54,1	2.13	31,2	1.23	5,8	0.23
4-8S	-08	1/4-18	63,0	2.48	33,8	1.33	7,6	0.30
6-8S	-08	3/8-18	63,0	2.48	33,8	1.33	9,1	0.36
8-8S	-08	1/2-14	69,3	2.73	40,1	1.58	9,1	0.36
8-10S	-10	1/2-14	73,2	2.88	40,4	1.59	11,7	0.46
12-10S	-10	3/4-14	74,7	2.94	41,9	1.65	11,7	0.46
8-12S	-12	1/2-14	82,3	3.24	42,7	1.68	12,4	0.49
12-12S	-12	3/4-14	82,3	3.24	42,4	1.67	14,0	0.55

*Requires tools for assembly; instructions located in Section L

† Also supplied in brass. To order, substitute "B" for "S" in part number

†† Available in stainless steel. To order, drop the "S" suffix and add "259-" prefix

Note: For correct socket part number, see page I-3.

For use with hose:
1503, 2580, 2651, FC234,
FC300, FC321, FC350,
FC355, FC802

Hose fittings – Reusable

SAE 100R5 style

100R5 style

15° elbow SAE male inverted flare

190350-

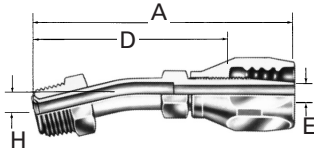

Dash size	Hose size	Thread	A		D		EØ		H	
			mm	in	mm	in	mm	in	mm	in
190350-										
6S	-06	5/8-18	82,8	3.26	59,9	2.36	6,1	0.24	9,4	0.37

45° elbow SAE male inverted flare

190371-

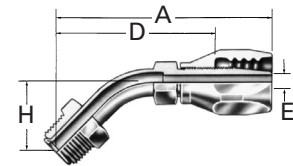

Dash size	Hose size	Thread	A		D		EØ		H	
			mm	in	mm	in	mm	in	mm	in
190371-										
4S	-04	7/16-20	69,6	2.74	50,5	1.99	3,3	0.13	24,4	0.96
5S	-05	1/2-20	73,7	2.90	53,8	2.12	4,3	0.17	24,4	0.96
5-6S	-06	1/2-20	76,2	3.00	53,3	2.10	6,1	0.24	24,4	0.96
6S	-06	5/8-18	76,2	3.00	53,3	2.10	6,1	0.24	24,4	0.96
8S	-08	3/4-18	86,1	3.39	56,9	2.24	9,1	0.36	23,6	0.93
10S	-10	7/8-18	95,0	3.74	62,0	2.44	11,7	0.46	26,2	1.03

90° elbow (short) SAE male inverted flare

190235-

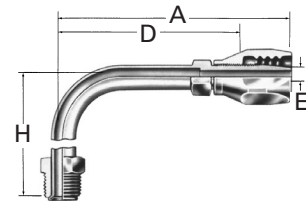

Dash size	Hose size	Thread	A		D		EØ		H	
			mm	in	mm	in	mm	in	mm	in
190235-										
4S	-04	7/16-24	59,9	2.36	41,1	1.62	3,3	0.13	42,9	1.69
5S	-05	1/2-20	64,3	2.53	44,5	1.75	4,6	0.18	42,9	1.69
5-6S	-06	1/2-20	66,8	2.63	43,9	1.73	6,1	0.24	43,9	1.73
6S	-06	5/8-18	66,8	2.63	43,9	1.73	6,1	0.24	43,9	1.73
7-6S	-06	11/16-18	66,8	2.63	43,9	1.73	6,1	0.24	43,9	1.73
6-8S	-08	5/8-18	77,2	3.04	48,0	1.89	7,1	0.28	43,9	1.73
7-8S	-08	11/16-18	77,2	3.04	48,0	1.89	7,1	0.28	43,9	1.73
8S	-08	3/4-18	77,2	3.04	48,0	1.89	9,1	0.36	44,5	1.75
10S	-10	7/8-18	87,4	3.44	54,6	2.15	11,7	0.46	56,4	2.22

90° elbow (long) SAE male inverted flare

190325-

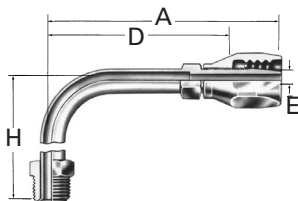

Dash size	Hose size	Thread	A		D		EØ		H	
			mm	in	mm	in	mm	in	mm	in
190325-										
6S	-06	5/8-18	93,2	3.67	70,4	2.77	6,1	0.24	69,3	2.73

Hose fittings – Reusable

SAE 100R5 style

For use with hose:
1503, 2580, 2651, FC234,
FC300, FC321, FC350,
FC355, FC802

100R5 style

ORS swivel straight FJ9706-

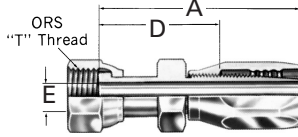

Dash size	Hose size	"T" Thread	A		D		EØ	
			mm	in	mm	in	mm	in
FJ9706-								
0404S	-04	9/16-18	53,1	2.09	34,0	1.34	3,3	0.13
0606S	-06	11/16-16	61,7	2.43	38,9	1.53	6,1	0.24
0808S	-08	13/16-16	79,5	3.13	50,8	1.98	9,1	0.36
1010S	-10	1-14	85,6	3.37	52,8	2.08	11,7	0.46
1212S	-12	1 3/16-12	93,5	3.68	53,6	2.11	14,0	0.55
1616S	-16	1 7/16-12	88,9	3.50	56,6	2.23	20,8	0.82
2020S	-20	1 11/16-12	92,5	3.64	57,9	2.28	26,7	1.05
2424S	-24	2-12	98,0	3.86	60,9	2.40	32,0	1.26

ORS swivel 45° elbow FJ9707-

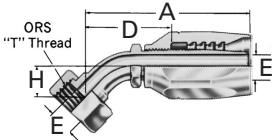

Dash size	Hose size	"T" Thread	A		D		EØ		H	
			mm	in	mm	in	mm	in	mm	in
FJ9707-										
0404S	-04	9/16-18	49,8	1.96	30,7	1.21	3,3	0.13	10,4	0.41
0606S	-06	11/16-16	57,7	2.27	34,8	1.37	5,6	0.22	10,9	0.43
0808S	-08	13/16-16	77,0	3.03	47,8	1.88	9,1	0.36	15,0	0.59
1010S	-10	1-14	85,9	3.38	52,8	2.08	11,7	0.46	16,5	0.65
1212S	-12	1 3/16-12	97,5	3.84	57,7	2.27	14,0	0.55	21,1	0.83
1616S	-16	1 7/16-12	91,9	3.62	59,7	2.35	19,3	0.76	23,9	0.94
2020S	-20	1 11/16-12	103,9	4.09	69,1	2.72	25,7	1.01	25,4	1.00
2424S	-24	2-12	109,7	4.32	72,9	2.87	32,0	1.26	27,2	1.07

ORS swivel 90° elbow (short drop) FJ9708-

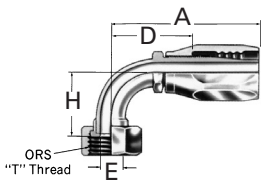

Dash size	Hose size	"T" Thread	A		D		EØ		H	
			mm	in	mm	in	mm	in	mm	in
FJ9708-										
0404S	-04	9/16-18	45,7	1.80	26,7	1.05	3,3	0.13	20,8	0.82
0606S	-06	11/16-16	54,1	2.13	31,2	1.23	5,6	0.22	22,9	0.90
0808S	-08	13/16-16	70,1	2.76	40,9	1.61	9,1	0.36	29,2	1.15
1010S	-10	1-14	77,0	3.03	44,2	1.74	11,7	0.46	32,3	1.27
1212S	-12	1 3/16-12	95,0	3.74	55,1	2.17	14,0	0.55	47,8	1.88
1616S	-16	7/16-12	90,2	3.55	57,9	2.28	19,3	0.76	56,1	2.21
2020S	-20	1 11/16-12	102,1	4.02	67,3	2.65	25,7	1.01	63,8	2.51
2424S	-24	2-12	112,2	4.42	75,4	2.97	32,0	1.26	68,6	2.70

Note: For correct socket part number, see page I-3.

For use with hose:
1503, 2580, 2651, FC234,
FC300, FC321, FC350,
FC355, FC802

Hose fittings – Reusable

SAE 100R5 style

100R5 style

90° elbow (long)

190295-Universal swivel
190301-SAE 45° swivel,
190260-SAE 37° (JIC) swivel

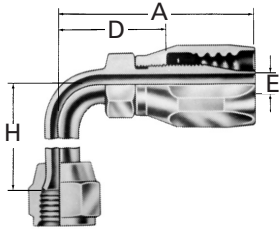

Dash size	Hose size	Thread	A		D		EØ		H	
			mm	in	mm	in	mm	in	mm	in
190295-										
4S	-04	7/16-20	44,2	1.74	25,1	0.99	3,3	0.13	45,7	1.80
5S	-05	1/2-20	49,8	1.96	30,0	1.18	4,6	0.18	45,0	1.77
8S	-08	3/4-16	73,2	2.88	43,9	1.73	9,1	0.36	61,7	2.43
10S	-10	7/8-14	81,0	3.19	48,3	1.90	11,7	0.46	65,3	2.57
10-12S	-12	7/8-14	88,6	3.49	48,8	1.92	12,2	0.48	65,3	2.57
190301-										
6S	-06	5/8-18	54,1	2.13	31,2	1.23	6,1	0.24	55,4	2.18
12S	-12	1 1/16-14	95,0	3.74	55,1	2.17	14,0	0.55	94,7	3.73
190260-										
6S	-06	9/16-18	54,1	2.13	31,2	1.23	6,1	0.24	55,4	2.18
12S	-12	1 1/16-12	95,0	3.74	55,1	2.17	14,0	0.55	94,7	3.73
16S	-16	1 5/16-12	90,2	3.55	57,9	2.28	20,8	0.82	116,3	4.58
20S	-20	1 5/8-12	102,1	4.02	67,3	2.65	26,7	1.05	140,5	5.53

Code 61 SAE J518 straight split flange

4775-

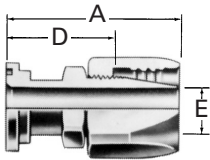

Dash size	Hose size	Flange head dia.		A		D		EØ		
		mm	in	mm	in	mm	in	mm	in	
4775-										
12S	-12	38,1	1.50	80,3	3.16	40,4	1.59	14,0	0.55	
16S	-16	44,5	1.75	70,4	2.77	38,1	1.50	20,8	0.82	
20-16S	-16	50,8	2.00	85,3	3.36	53,1	2.09	20,8	0.82	
16-20S	-20	44,5	1.75	75,9	2.99	41,1	1.62	20,8	0.82	
20S	-20	50,8	2.00	90,9	3.58	56,1	2.21	26,7	1.05	
32-20S	-20	71,4	2.81	92,5	3.64	57,9	2.28	26,7	1.05	
16-24S*	-24	44,5	1.75	94,7	3.73	57,9	2.28	20,8	0.82	
20-24S	-24	50,8	2.00	93,2	3.67	56,4	2.22	26,7	1.05	
24S	-24	60,5	2.38	102,1	4.02	65,0	2.56	32,5	1.28	
32-24S	-24	71,4	2.81	102,1	4.02	65,0	2.56	32,5	1.28	
24-32S	-32	60,5	2.38	112,3	4.42	65,5	2.58	34,8	1.37	
32S	-32	71,4	2.81	125,0	4.92	78,2	3.08	44,5	1.75	
40-32S	-32	84,1	3.31	126,5	4.98	79,8	3.14	44,5	1.75	
40**	-40	84,1	3.31	136,1	5.36	87,6	3.45	56,1	2.21	

*MTO Made to order

**Order as 39-4775-40

Note: For flanges, split flange halves, kits and o-rings, see page I-61–I-68.

Hose fittings – Reusable

SAE 100R5 style

For use with hose:
1503, 2580, 2651, FC234,
FC300, FC321, FC350,
FC355, FC802

100R5 style

Code 61 SAE J518
22 1/2° split flange
4776-

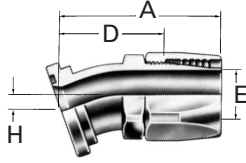

Dash size	Hose size	Flange head dia.		A		D		EØ		H	
		mm	in	mm	in	mm	in	mm	in	mm	in
4776-											
32-20S*	-20S	71,4	2.81	98,6	3.88	63,8	2.51	26,7	1.05	13,2	0.52
32S	-32	71,4	2.81	116,6	4.59	69,9	2.75	44,5	1.75	12,7	0.50

Code 61 SAE J518
30° split flange
198046-

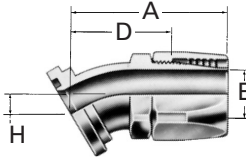

Dash size	Hose size	Flange head dia.		A		D		EØ		H	
		mm	in	mm	in	mm	in	mm	in	mm	in
190846-											
20-16S*	-16	50,8	2.00	84,3	3.32	52,1	2.05	20,8	0.82	12,7	0.50
24S	-24	60,5	2.38	100,6	3.96	63,8	2.51	32,5	1.28	14,7	0.58
32S	-32	71,4	2.81	118,9	4.68	72,1	2.84	44,5	1.75	16,5	0.65

Code 61 SAE J518
45° split flange
4777-

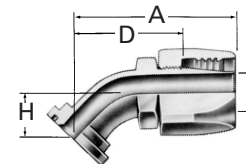

Dash size	Hose size	Flange head dia.		A		D		EØ		H	
		mm	in	mm	in	mm	in	mm	in	mm	in
4777-											
12S	-12	38,1	1.50	102,1	4.02	62,2	2.45	14,0	0.55	25,4	1.00
16-12S*	-12	44,5	1.75	102,1	4.02	62,2	2.45	14,0	0.55	25,4	1.00
16S	-16	44,5	1.75	96,5	3.80	64,3	2.53	20,8	0.82	28,4	1.12
16-20S*	-20	44,5	1.75	101,9	4.01	67,3	2.65	20,8	0.82	28,4	1.12
20S	-20	50,8	2.00	104,6	4.12	69,9	2.75	26,7	1.05	28,4	1.12
32-20S	-20	46,0	1.81	105,7	4.16	71,1	2.80	26,7	1.05	29,7	1.17
24S	-24	60,5	2.38	111,3	4.38	74,2	2.92	32,5	1.28	28,4	1.12
24-32S	-32	60,5	2.38	121,4	4.78	74,7	2.94	34,8	1.37	28,4	1.12
32-24S	-24	71,4	2.81	111,3	4.38	74,2	2.92	32,5	1.28	28,4	1.12
32S	-32	71,4	2.81	131,6	5.18	84,6	3.33	44,5	1.75	31,8	1.25
40-32S	-32	84,1	3.31	132,6	5.22	85,9	3.38	44,5	1.75	33,0	1.30
40**	-40	84,1	3.31	167,1	6.58	118,6	4.67	56,1	2.21	42,1	1.66

*MTO Made to order

**Order as 39-4777-40

For correct socket part number, see page I-3.

Note: For flanges, split flange halves, kits and o-rings, see page I-61–I-68.

For use with hose:
1503, 2580, 2651, FC234,
FC300, FC321, FC350,
FC355, FC802

Hose fittings – Reusable

SAE 100R5 style

100R5 style

Code 61 SAE J518 60° split flange

191395-

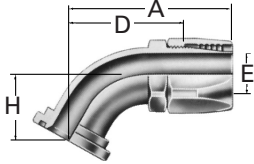

Dash size	Hose size	Flange head dia.		A		D		EØ		H	
		mm	in	mm	in	mm	in	mm	in	mm	in
191395-											
24S	-24	60,5	2.38	120,1	4.73	83,3	3.28	32,5	1.28	50,8	2.00

Code 61 SAE J518 90° split flange

4779-

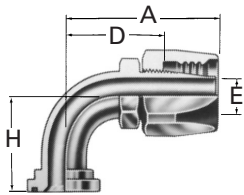

Dash size	Hose size	Flange head dia.		A		D		EØ		H	
		mm	in	mm	in	mm	in	mm	in	mm	in
4779-											
8S	-08	30,2	1.19	73,2	2.88	43,9	1.73	9,1	0.36	41,1	1.62
12S	-12	38,1	1.50	95,0	3.74	55,1	2.17	14,0	0.55	53,8	2.12
16-12S	-12	44,5	1.75	95,0	3.74	55,1	2.17	14,0	0.55	53,8	2.12
16S	-16	44,5	1.75	90,2	3.55	57,9	2.28	20,8	0.82	60,5	2.38
20-16S	-16	50,8	2.00	90,2	3.55	57,9	2.28	20,8	0.82	60,5	2.38
16-20S	-20	44,5	1.75	95,5	3.76	60,9	2.40	20,8	0.82	60,5	2.38
20S	-20	50,8	2.00	102,1	4.02	67,3	2.65	26,7	1.05	63,5	2.50
24-20S	-20	60,5	2.38	102,1	4.02	67,3	2.65	26,7	1.05	63,5	2.50
32-20S	-20	71,4	2.81	102,1	4.02	67,3	2.65	26,7	1.05	65,0	2.56
20-24S	-24	50,8	2.00	104,4	4.11	67,6	2.66	26,7	1.05	63,5	2.50
24S	-24	60,5	2.38	112,2	4.42	75,4	2.97	32,5	1.28	69,9	2.75
24-32S	-32	60,5	2.38	122,7	4.83	75,7	2.98	34,8	1.37	69,9	2.75
32S	-32	71,4	2.81	136,9	5.39	90,2	3.55	44,5	1.75	82,6	3.25
40-32S	-32	84,1	3.31	136,9	5.39	90,2	3.55	44,5	1.75	84,1	3.31
40**	-40	84,1	3.31	184,4	7.26	136,1	5.36	56,1	2.21	131,8	5.19

*MTO Made to order
**Order as 39-4779-40

Male inverted flare

190277-

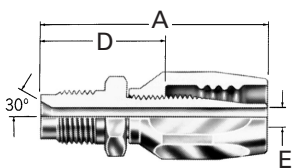

Dash size	Hose size	Thread	A		D		EØ	
			mm	in	mm	in	mm	in
190277-								
4S	-04	7/16-20	45,7	1.80	26,7	1.05	3,3	0.13

Note: For flanges, split flange halves, kits and o-rings, see page I-61–I-68.

Hose fittings – Reusable

SAE 100R5 style

For use with hose:
1503, 2580, 2651, FC234,
FC300, FC321, FC350,
FC355, FC802

100R5 style

Male/female inverted flare
190276-

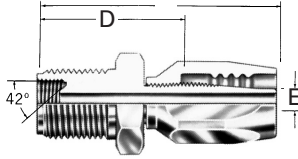

Dash size	Hose size	Thread	A		D		EØ	
			mm	in	mm	in	mm	in
190276-								
4S	-04	5/8-18(M)	52,1	2.05	33,0	1.30	3,3	0.13

Female inverted flare
403-

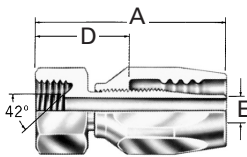

Dash size	Hose size	Thread	A		D		EØ	
			mm	in	mm	in	mm	in
403-								
5S	-05	1/2-20	41,1	1.62	21,3	0.84	5,8	0.23
6S	-06	5/8-18	45,2	1.78	22,4	0.88	7,6	0.30

Compression ball sleeve
FC7031-

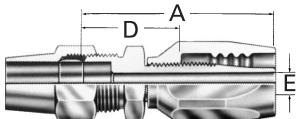

Dash size	Hose size	Thread	A		D		EØ	
			mm	in	mm	in	mm	in
FC7031-								
1010-206	-10	5/8	66,5	2.62	34,0	1.34	11,7	0.46

**Straight SAE
Male inverted flare**
190111-

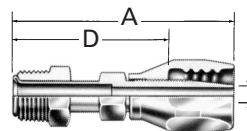

Dash size	Hose size	Thread	A		D		EØ	
			mm	in	mm	in	mm	in
190111-								
4S	-04	7/16-24	62,5	2.46	43,4	1.71	3,3	0.13
5S	-05	1/2-20	66,5	2.62	46,7	1.84	4,6	0.18
5-6S	-06	1/2-20	69,1	2.72	46,2	1.82	6,1	0.24
6S	-06	5/8-18	69,1	2.72	46,2	1.82	6,1	0.24
6-8S	-08	5/8-18	79,5	3.13	50,8	1.98	7,1	0.28
8S	-08	3/4-18	81,3	3.20	52,1	2.05	9,1	0.36
10S	-10	7/8-18	90,4	3.56	57,9	2.28	11,4	0.45

Notes: For correct socket part number, see page I-3.

For use with hose:
1503, 2580, 2651, FC234,
FC300, FC321, FC350,
FC355, FC802

Hose fittings – Reusable

SAE 100R5 style

100R5 style

45° elbow

190297-Universal swivel
190299-SAE 45° swivel
190265-SAE 37° (JIC) swivel

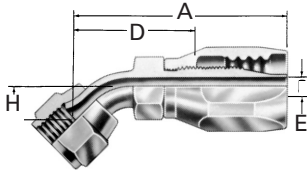

Dash size	Hose size	Thread	A		D		EØ		H	
			mm	in	mm	in	mm	in	mm	in
190297-										
4S	-04	7/16-20	47,0	1.85	27,9	1.10	3,3	0.13	8,4	0.33
4-5S	-05	7/16-20	51,1	2.01	31,2	1.23	3,8	0.15	8,4	0.33
5S	-05	1/2-20	52,6	2.07	32,8	1.29	4,6	0.18	9,1	0.36
8-6S	-06	3/4-16	67,1	2.64	44,2	1.74	6,1	0.24	14,0	0.55
8S	-08	3/4-16	75,9	2.99	46,7	1.72	9,1	0.36	14,0	0.55
8-10S	-10	3/4-16	79,8	3.14	47,0	1.85	9,9	0.39	14,0	0.55
10S	-10	7/8-14	82,3	3.24	49,5	1.95	11,7	0.46	16,3	0.64
10-12S	-12	7/8-14	89,9	3.54	50,0	1.97	12,2	0.48	16,3	0.64
190299-										
6S	-06	5/8-18	56,6	2.23	33,8	1.33	6,1	0.24	9,9	0.39
12S	-12	1 1/16-14	96,0	3.78	56,1	2.21	14,0	0.55	19,8	0.78
190265-										
6S	-06	9/16-18	56,6	2.23	33,8	1.33	6,1	0.24	9,9	0.39
12S	-12	1 1/16-12	96,0	3.78	56,1	2.21	14,0	0.55	19,8	0.78
16S	-16	1 5/16-12	95,0	3.74	62,7	2.47	20,8	0.82	27,2	1.07
20S	-20	1 1/8-12	106,9	4.21	72,4	2.85	26,7	1.05	31,0	1.22

90° elbow (short)

190296-Universal swivel
190302-SAE 45° swivel
190261-SAE 37° (JIC) swivel

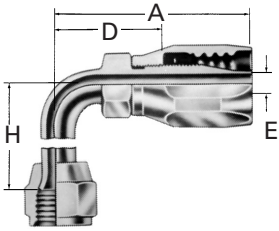

Dash size	Hose size	Thread	A		D		EØ		H	
			mm	in	mm	in	mm	in	mm	in
190296-										
4S	-04	7/16-20	44,2	1.74	25,1	0.99	3,3	0.13	17,3	0.68
5S	-05	1/2-20	49,8	1.96	30,0	1.18	4,3	0.17	19,6	0.77
8S	-08	3/4-16	70,1	2.76	40,9	1.61	9,1	0.36	27,7	1.09
8-10S	-10	3/4-16	73,9	2.91	41,1	1.62	9,9	0.39	27,7	1.09
10S	-10	7/8-14	74,7	2.94	41,9	1.65	11,7	0.46	31,2	1.23
10-12S	-12	7/8-14	82,3	3.24	42,4	1.67	12,2	0.48	31,2	1.23
8-12S	-12	3/4-16	81,5	3.21	41,7	1.64	9,9	0.39	27,7	1.09
190302-										
6S	-06	5/8-18	54,1	2.13	31,2	1.23	6,1	0.24	21,6	0.85
12S	-12	1 1/16-14	95,0	3.74	55,1	2.17	14,0	0.55	46,2	1.82
190261-										
6S	-06	9/16-18	54,1	2.13	31,2	1.23	6,1	0.24	21,6	0.85
12S	-12	1 1/16-12	95,0	3.74	55,1	2.17	14,0	0.55	46,2	1.82
16-12S*	-12	1 5/16-12	95,0	3.74	55,1	2.17	14,0	0.55	54,4	2.14
16S	-16	1 5/16-12	90,2	3.55	57,9	2.28	20,8	0.82	58,4	2.30
20-16S*	-16	1 5/8-12	90,2	3.55	57,9	2.28	19,3	0.76	63,5	2.50
20S	-20	1 5/8-12	102,1	4.02	67,3	2.65	26,7	1.05	69,9	2.75
20-24S*	-24	1 5/8-12	104,4	4.11	67,6	2.66	26,7	1.05	69,9	2.75

*MTO Made to order

Notes: For correct socket part number, see page I-3.

Hose fittings – Reusable

SAE 100R5 style

For use with hose:
1503, 2580, 2651, FC234,
FC300, FC321, FC350,
FC355, FC802

100R5 style

SAE 37° (JIC) male flare

4414-

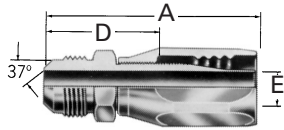

Dash size	Hose size	Thread	A		D		EØ	
			mm	in	mm	in	mm	in
4414-								
4S	-04	7/16-20	47,0	1.85	27,9	1.10	3,3	0.13
5S	-05	1/2-20	49,5	1.95	29,7	1.17	4,3	0.17
6S	-06	9/16-18	53,8	2.12	31,0	1.22	6,1	0.24
8S	-08	3/4-16	65,3	2.57	36,1	1.42	9,1	0.36
10S	-10	7/8-14	73,2	2.88	40,6	1.60	11,7	0.46
12-10S	-10	1 1/16-12	77,5	3.05	44,7	1.76	11,7	0.46
12S	-12	1 1/16-12	85,1	3.35	45,2	1.78	14,0	0.55
16S	-16	1 5/16-12	75,2	2.96	42,9	1.69	20,8	0.82
20S	-20	1 5/8-12	81,8	3.22	47,2	1.86	26,7	1.05
24S	-24	1 7/8-12	87,4	3.44	50,5	1.99	32,5	1.28

SAE 45° male flare

4402-

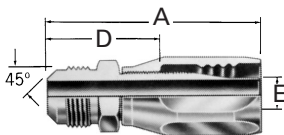

Dash size	Hose size	Thread	A		D		EØ	
			mm	in	mm	in	mm	in
4402-								
4S	-04	7/16-20	45,7	1.80	26,9	1.06	3,3	0.13
5S	-05	1/2-20	50,0	1.97	30,0	1.18	4,3	0.17
6S	-06	5/8-18	55,6	2.19	32,5	1.28	6,1	0.24
8S	-08	3/4-16	67,6	2.66	38,6	1.52	9,1	0.36
10S	-10	7/8-14	76,2	3.00	43,7	1.72	11,7	0.46
12S	-12	1 1/16-14	88,9	3.50	48,8	1.92	14,2	0.56

Lifesaver†

190000-

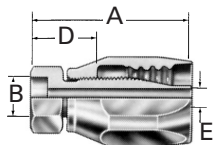

Dash size	Hose size	Tube	A		B†		D		EØ	
			mm	in	mm	in	mm	in	mm	in
190000-										
4S	-04	1/4	34,5	1.36	6,4	0.25	15,7	0.62	3,3	0.13
5S	-05	5/16	38,9	1.53	7,9	0.31	19,1	0.75	4,6	0.18
5-6S	-06	5/16	41,4	1.63	7,9	0.31	18,5	0.73	6,1	0.24
6S	-06	3/8	41,4	1.63	9,7	0.38	18,5	0.73	6,1	0.24
6-8S	-08	3/8	51,8	2.04	9,7	0.38	22,6	0.89	7,1	0.28
8S	-08	1/2	51,8	2.04	12,7	0.50	22,6	0.89	9,1	0.36
10S	-10	5/8	55,6	2.19	15,7	0.62	22,9	0.90	11,7	0.46
12S	-12	3/4	63,2	2.49	19,1	0.75	23,4	0.92	14,0	0.55
16S	-16	1	52,1	2.05	25,4	1.00	19,8	0.78	20,8	0.82
20S	-20	1 1/4	57,4	2.26	31,8	1.25	22,9	0.90	26,7	1.05
24-20S	-20	1/2	59,2	2.33	38,1	1.50	24,4	0.96	26,7	1.05
24S	-24	1/2	61,5	2.42	38,1	1.50	24,6	0.97	32,5	1.28
32S	-32	2	73,4	2.89	50,8	2.00	26,7	1.05	44,5	1.75
40S	-40	2 1/2	82,8	3.26	63,5	2.50	34,5	1.36	56,1	2.21

**For flanges, split flange halves, kits and o-rings, see page I-61–I-68.

† "B" dimension is counterbore diameter for mating tubing

Notes: For correct socket part number, see page I-3.

For use with hose:
1503, 2580, 2651, FC234,
FC300, FC321, FC350,
FC355, FC802

Hose fittings – Reusable

SAE 100R5 style

100R5 style

SAE 45° swivel

401-

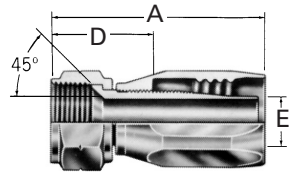

Dash size	Hose size	Thread	A		D		EØ	
			mm	in	mm	in	mm	in
401-								
4S*†	-04	7/16-20	44,5	1.75	25,4	1.00	4,3	0.17
5S*†	-05	1/2-20	48,3	1.90	28,4	1.12	5,8	0.23
6S*†	-06	5/8-18	52,1	2.05	29,2	1.15	7,6	0.30
8S*†	-08	3/4-16	64,0	2.52	35,1	1.38	9,9	0.39
10S*†	-10	7/8-14	71,1	2.80	38,4	1.51	12,2	0.48
12S*†	-12	1 1/16-14	76,7	3.02	36,8	1.45	15,5	0.61

SAE 45° swivel

4401-

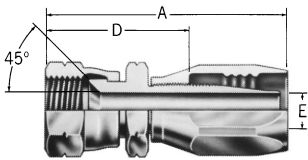

Dash size	Hose size	Thread	A		D		EØ	
			mm	in	mm	in	mm	in
4401-								
4S†	-04	7/16-20	50,0	1.97	31,0	1.22	3,3	0.13
5S	-05	1/2-20	53,8	2.12	34,0	1.34	4,3	0.17
6S†	-06	5/8-18	59,9	2.36	37,1	1.46	6,1	0.24
8S†	-08	3/4-16	70,6	2.78	41,1	1.62	9,1	0.36
8-6S	-06	3/4-16	61,5	2.42	38,9	1.53	5,6	0.22
10S†	-10	7/8-14	78,7	3.10	46,0	1.81	11,7	0.46
12S†	-12	1 1/16-14	88,6	3.49	48,8	1.92	14,0	0.55

SAE PTT swivel

406-

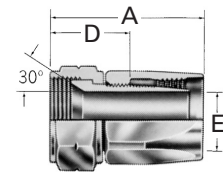

Dash size	Hose size	Thread	A		D		EØ	
			mm	in	mm	in	mm	in
406-								
16S†††*	-16	1 5/16-14	66,0	2.60	33,8	1.33	20,8	0.82
20S†††*	-20	1 5/8-14	72,6	2.86	38,1	1.50	26,7	1.05
24B*	-24	1 7/8-14	79,5	3.13	42,4	1.67	32,5	1.28

SAE male O-ring boss**

190463-

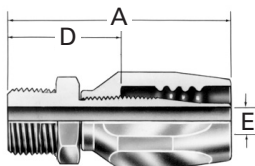

Dash size	Hose size	Thread	A		D		EØ	
			mm	in	mm	in	mm	in
190463-								
6S	-06	9/16-18	49,5	1.95	26,7	1.05	6,1	0.24
8S	-08	3/4-16	59,7	2.35	30,5	1.20	9,1	0.36
10S	-10	7/8-14	66,8	2.63	34,0	1.34	9,1	0.36

**See page I-63–I-68 for o-ring information.

*Requires tools for assembly; instructions located in Section L

† Also supplied in brass. To order, substitute "B" for "S" in part number

††† Available in stainless steel. To order, drop the "S" suffix and add "259-" prefix

Hose fittings – Reusable

SAE 100R5 style

For use with hose:
1503, 2580, 2651, FC234,
FC300, FC321, FC350,
FC355, FC802

100R5 style

SAE 37° (JIC) swivel

411-
44-411-

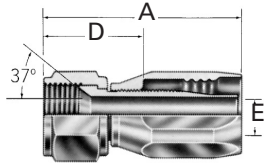

Dash size	Hose size	Thread	A		D		EØ	
			mm	in	mm	in	mm	in
411-			mm	in	mm	in	mm	in
†4S *	-04	7/16-20	44,5	1.75	25,4	1.00	4,3	0.17
†5S *	-05	1/2-20	48,3	1.90	28,4	1.12	5,8	0.23
†6S *	-06	9/16-18	52,1	2.05	29,2	1.15	7,6	0.30
6-4S	-04	9/16-18	47,0	1.85	27,9	1.10	4,3	0.17
†8S *	-08	3/4-16	64,0	2.52	35,1	1.38	9,9	0.39
10S *	-10	7/8-14	71,1	2.80	38,4	1.51	12,2	0.48
10-8B	-08	7/8-14	67,2	2.65	38,1	1.50	9,9	0.39
†12S *	-12	1 1/16-12	80,0	3.15	40,1	1.58	15,5	0.61
†16S *	-16	1 5/16-12	71,6	2.82	39,4	1.55	20,8	0.82
16-12S	-12	1 5/16-12	82,6	3.25	40,9	1.61	15,5	0.61
†20S *†††	-20	1 5/8-12	76,2	3.00	41,7	1.64	26,7	1.05
†24S *†††	-24	1 7/8-12	83,3	3.28	46,5	1.83	32,5	1.28
†32S *†††	-32	2 1/2-12	98,6	3.88	51,6	2.03	44,5	1.75
44-411-			mm	in	mm	in	mm	in
40 *	-40	3-12	105,7	4.16	57,2	2.25	55,9	2.20
48 *	-48	3 1/2-12	108,7	4.28	60,5	2.38	71,1	2.80

SAE 37° (JIC) swivel

4411-

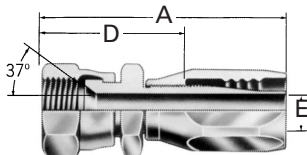

Dash size	Hose size	Thread	A		D		EØ	
			mm	in	mm	in	mm	in
4411-			mm	in	mm	in	mm	in
4S †††	-04	7/16-20	50,0	1.97	31,2	1.23	3,3	0.13
4-5S	-05	7/16-20	52,8	2.08	33,0	1.30	4,3	0.17
5S †††	-05	1/2-20	53,8	2.12	34,3	1.35	4,6	0.18
6S †††	-06	9/16-18	59,2	2.33	36,3	1.43	6,1	0.24
6-8S	-08	9/16-18	68,1	2.68	38,9	1.53	7,6	0.30
8S †††	-08	3/4-16	70,6	2.78	41,1	1.62	9,1	0.36
8-6S	-06	3/4-16	61,5	2.42	38,6	1.52	6,1	0.24
10-8S	-08	7/8-14	74,9	2.95	45,7	1.80	9,1	0.36
8-10S	-10	3/4-16	74,2	2.92	41,7	1.64	9,9	0.39
10S †††	-10	7/8-14	78,7	3.10	46,0	1.81	11,7	0.46
12-10S	-10	1 1/16-12	81,0	3.19	48,5	1.91	11,7	0.46
10-12S	-12	7/8-14	86,4	3.40	46,5	1.83	14,0	0.55
12S †††	-12	1 1/16-12	88,6	3.49	48,8	1.92	14,0	0.55
14-12S	-12	1 3/16-12	90,6	3.56	50,5	1.99	14,0	0.55
16S †††	-16	1 5/16-12	81,0	3.19	49,0	1.93	20,8	0.82
16-20S	-20	1 5/16-12	87,1	3.43	52,6	2.07	26,7	1.05
20S	-20	1 5/8-12	87,1	3.43	52,6	2.07	26,7	1.05
20-24S	-24	1 5/8-12	92,7	3.65	55,6	2.19	26,9	1.06
24S	-24	1 7/8-12	93,5	3.68	56,4	2.22	32,5	1.28
32S	-32	2 1/2-12	111,5	4.39	64,8	2.55	44,5	1.75

*Requires tools for assembly; instructions located in Section L

† Also supplied in brass. To order, substitute "B" for "S" in part number

††† Available in stainless steel. To order, drop the "S" suffix and add "259-" prefix

For use with hose:
1503, 2580, 2651, FC234,
FC300, FC321, FC350,
FC355, FC802

Hose fittings – Reusable

SAE 100R5 style

100R5 style

ORS swivel 90° elbow (long drop)

FJ9709-

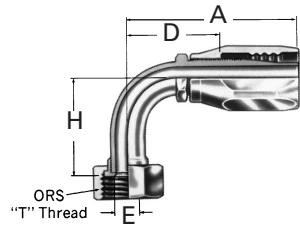

Dash size	Hose size	"T" Thread	A		D		EØ		H	
			mm	in	mm	in	mm	in	mm	in
FJ9709-										
0606S	-06	11/16-16	57,2	2.25	34,3	1.35	5,6	0.22	54,1	2.13
0808S	-08	13/16-16	73,2	2.88	43,9	1.73	9,1	0.36	63,8	2.51
1010S	-10	1-14	77,0	3.03	44,2	1.74	11,7	0.46	70,1	2.76
1212S	-12	1 3/16-12	95,0	3.74	55,1	2.17	14,0	0.55	96,0	3.78
1616S	-16	7/16-12	90,2	3.55	57,7	2.27	19,3	0.76	114,3	4.50
2020S	-20	1 11/16-12	102,1	4.02	67,3	2.65	25,7	1.01	129,3	5.09

Metric male 60° DIN 7631/7647

07.024-

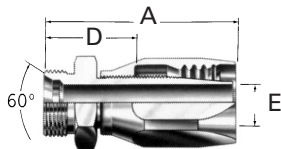

Dash size	Hose size	Thread	A		D		EØ	
			mm	in	mm	in	mm	in
07.024-								
4-4	-04	M12 x 1.5	45,0	1.77	26,0	1.02	3,2	0.13
6-5	-05	M14 x 1.5	47,5	1.87	27,5	1.08	4,5	0.18
8-6*	-06	M16 x 1.5	50,0	1.97	27,0	1.06	6,0	0.24
10-8	-08	M18 x 1.5	59,0	2.32	30,0	1.18	9,0	0.35
13-10*	-10	M22 x 1.5	65,0	2.56	32,0	1.26	11,5	0.45
16-12	-12	M26 x 1.5	72,5	2.85	32,5	1.28	14,0	0.55
20-16	-16	M30 x 1.5	63,0	2.48	31,0	1.22	21,0	0.83
25-20	-20	M38 x 1.5	67,5	2.66	33,0	1.30	26,5	1.04
32-24	-24	M45 x 1.5	70,0	2.76	33,0	1.30	32,5	1.28
40-32	-32	M52 x 1.5	84,0	3.31	37,0	1.46	44,5	1.28
50-32	-32	M65 x 2	87,0	3.42	40,0	1.57	44,5	1.75
60-40	-40	M78 x 2	94,5	3.72	46,0	1.81	56,0	2.20
70-48	-48	M90 x 2	100,5	3.96	52,0	2.05	71,0	2.80

Metric female swivel 60° DIN 7631/7647

07.036-

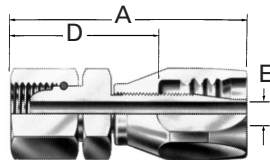

Dash size	Hose size	Thread	A		D		EØ	
			mm	in	mm	in	mm	in
07.036-								
20-16*	-16	M30 x 1.5	72,5	2.85	40,9	1.61	21,0	0.83
25-20*	-20	M38 x 1.5	76,5	3.01	42,0	1.65	26,5	1.04
32-24*	-24	M45 x 1.5	82,0	3.23	45,0	1.77	32,5	1.28
40-32	-32	M52 x 1.5	93,5	3.68	46,5	1.83	44,5	1.75
50-32	-32	M65 x 2	93,5	3.68	46,5	1.83	44,5	1.75
60-40*	-40	M78 x 2	103,0	4.06	54,5	2.15	56,0	2.20

Hose fittings – Reusable

SAE 100R5 style

For use with hose:
1503, 2580, 2651, FC234,
FC300, FC321, FC350,
FC355, FC802

100R5 style

Metric universal female swivel 24°
DIN 3901/3902 I.Rh.
07.002-

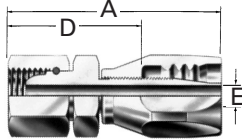

Dash size	Hose size	Thread	A		D		EØ		RØ	
			mm	in	mm	in	mm	in	mm	in
07.002-										
4-4†	-04	M12 x 1.5	51,0	2.01	32,0	1.26	3,2	0.13	6,0	0.24
6-5†	-05	M14 x 1.5	53,5	2.11	33,5	1.32	4,5	0.18	8,0	0.31
8-6†	-06	M16 x 1.5	56,5	2.22	33,5	1.32	6,0	0.24	10,0	0.39
10-8†	-08	M18 x 1.5	67,0	2.64	37,5	1.48	9,0	0.35	12,0	0.47
13-10†	-10	M22 x 1.5	73,0	2.87	40,5	1.59	11,5	0.45	15,0	0.59
16-12†	-12	M26 x 1.5	83,5	3.29	43,5	1.71	14,0	0.55	18,0	0.71
22-16	-16	M30 x x 2	74,0	2.91	41,5	1.63	21,0	0.83	22,0	0.87
28-20	-20	M36 x x 2	78,0	3.07	43,5	1.71	26,5	1.04	28,0	1.10
35-24*	-24	M45 x x 2	81,5	3.21	44,5	1.75	32,5	1.28	35,0	1.38
42-32	-32	M52 x x 2	94,0	3.70	47,0	1.85	44,5	1.75	42,0	1.65

*MTO Made to order

Metric universal female swivel 24°
DIN 3901/3902 s.Rh.
07.155-

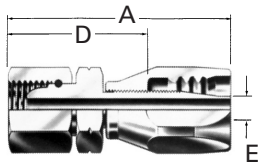

Dash size	Hose size	Thread	A		D		EØ		RØ	
			mm	in	mm	in	mm	in	mm	in
07.155-										
10-5	-05	M18 x 1.5	55,0	2.17	35,0	1.38	4,5	0.18	10,0	0.39
12-6*	-06	M20 x 1.5	59,5	2.34	36,5	1.44	6,0	0.24	12,0	0.47
14-8*	-08	M22 x 1.5	68,5	2.70	39,0	1.54	9,0	0.35	14,0	0.55
20-12	-12	M30 x 2	85,5	3.37	45,5	1.79	14,0	0.55	20,0	0.79
25-16	-16	M36 x 2	75,0	2.95	42,5	1.67	21,0	0.83	25,0	0.98
38-24*	-24	M52 x 2	84,0	3.31	47,0	1.85	32,5	1.28	38,0	1.50

Komatsu 30° metric female swivel
FC5954-

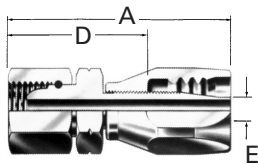

Dash size	Hose size	Thread	A		D		EØ	
			mm	in	mm	in	mm	in
FC5954-								
0410S*	-10	M22 x 1.5	78,7	3.10	46,2	1.82	9,4	0.37
0612S	-12	M30 x 1.5	95,5	3.76	55,6	2.19	14,0	0.55

*MTO Made to order

† Universal fitting also mates with DIN 7631/7647 60° connections.

100R1 TTC

Male pipe

FC7985-

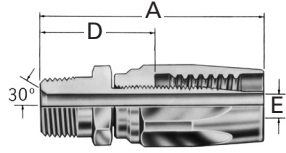

Dash size	Hose size	Thread	A		D		EØ	
			mm	in	mm	in	mm	in
FC7985-								
0204S	-04	1/8-27	55,1	2.17	28,7	1.13	4,3	0.17
0404S	-04	1/4-18	59,9	2.36	33,5	1.32	4,3	0.17
0406S	-06	1/4-18	68,1	2.68	39,4	1.55	7,6	0.30
0606S	-06	3/8-18	68,1	2.68	39,4	1.55	7,9	0.31
0608S	-08	3/8-18	71,6	2.82	34,3	1.35	9,9	0.39
0808S	-08	1/2-14	78,0	3.07	40,6	1.60	9,9	0.39
1212S	-12	3/4-14	90,2	3.55	49,5	1.95	15,5	0.61
1616S	-16	1-11 1/2	108,0	4.25	54,1	2.13	20,8	0.82

SAE 37° (JIC) swivel

FC7988-

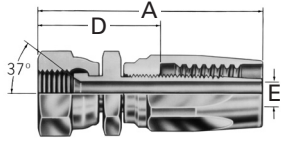

Dash size	Hose size	Thread	A		D		EØ	
			mm	in	mm	in	mm	in
FC7988-								
0404S	-04	7/16-20	63,5	2.50	37,1	1.46	4,3	0.17
0606S	-06	9/16-18	73,9	2.91	45,2	1.78	7,9	0.31
0808S	-08	3/4-16	80,8	3.18	43,8	1.70	9,9	0.39
1212S	-12	1 1/16-12	96,5	3.80	55,9	2.20	15,5	0.61
1616S	-16	1 5/16-12	110,0	4.33	56,1	2.21	20,8	0.82

SAE 37° (JIC) male flare

FC7986-

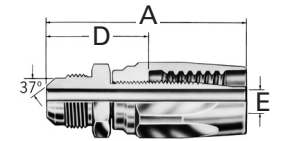

Dash size	Hose size	Thread	A		D		EØ	
			mm	in	mm	in	mm	in
FC7986-								
0404S	-04	7/16-20	59,4	2.34	33,0	1.30	4,3	0.17
0606S	-06	9/16-18	67,8	2.67	39,1	1.54	7,9	0.31
0808S	-08	3/4-16	75,4	2.97	38,1	1.50	9,9	0.39
1212S	-12	1 1/16-12	93,0	3.66	52,3	2.06	15,5	0.61
1616S	-16	1 5/16-12	107,4	4.23	53,3	2.10	20,8	0.82

SAE male O-ring boss

FC7987-

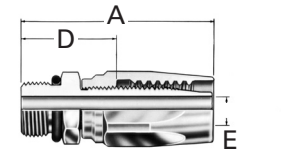

Dash size	Hose size	Thread	A		D		EØ	
			mm	in	mm	in	mm	in
FC7987-								
0606S	-06	9/16-18	63,5	2.50	34,8	1.37	7,9	0.31
0808S	-08	3/4-16	68,3	2.69	31,0	1.22	9,9	0.39
1212S	-12	1 1/16-12	86,4	3.40	45,7	1.80	15,5	0.61
1616S	-16	1 5/16-12	96,0	3.78	41,9	1.65	20,8	0.82

Lifesaver*

FC7989-

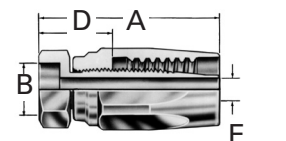

Dash size	Hose size	Thread	A		B*		D		RØ	
			mm	in	mm	in	mm	in	mm	in
FC7989-										
0404S	-04	1/4	48,0	1.89	6,4	0.25	21,6	0.85	4,3	0.17
0606S	-06	3/8	54,6	2.15	9,7	0.38	25,9	1.02	7,9	0.31
0808S	-08	1/2	60,5	2.38	12,7	0.50	23,1	0.91	9,9	0.39
1212S	-12	3/4	71,1	2.80	19,1	0.75	30,5	1.20	15,5	0.61
1616S	-16	1	81,0	3.19	25,4	1.00	26,9	1.06	20,8	0.82

*"B" dimension is counterbore for mating tubing.

¹SAE 100R2 pressures only.

Hose fittings – Reusable

For use with hose:
GH663¹

Braided hydraulic – one wire

100R1 TTC

SAE 37° (JIC) swivel 45° elbow

FC7990-

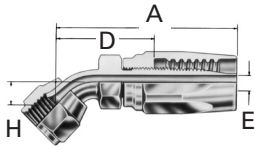

Dash size	Hose size	Thread	A		D		EØ		HØ	
			mm	in	mm	in	mm	in	mm	in
FC7990-										
0404S	-04	7/16-20	60,2	2.37	33,8	1.33	4,3	0.17	8,4	0.33
0606S	-06	9/16-18	69,9	2.75	41,1	1.62	7,9	0.31	9,9	0.39
0808S	-08	3/4-16	82,3	3.24	45,0	1.77	9,9	0.39	14,0	0.55
1212S	-12	1 1/16-12	103,9	4.09	63,2	2.49	15,5	0.61	19,8	0.78
1616S	-16	1 5/16-12	124,0	4.88	69,9	2.75	20,8	0.82	27,2	1.07

SAE 37° (JIC) swivel 90° elbow (short)

FC7992-

SAE 37° (JIC) swivel 90° elbow (long)

FC7991-

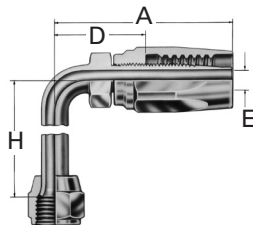

Dash size	Hose size	Thread	A		D		EØ		HØ	
			mm	in	mm	in	mm	in	mm	in
FC7992-										
0404S	-04	7/16-20	57,4	2.26	31,0	1.22	4,3	0.17	17,3	0.68
0606S	-06	9/16-18	67,3	2.65	38,6	1.52	7,9	0.31	21,6	0.85
0808S	-08	3/4-16	76,2	3.00	39,1	1.54	9,9	0.39	27,7	1.09
1212S	-12	1 1/16-12	102,9	4.05	62,2	2.45	15,5	0.61	46,2	1.82
1616S	-16	1 5/16-12	119,1	4.69	65,0	2.56	20,8	0.82	60,7	2.39
FC7991-										
0404S	-04	7/16-20	57,4	2.26	31,0	1.22	4,3	0.17	45,7	1.80
0606S	-06	5/16-18	67,3	2.65	38,6	1.52	7,9	0.31	55,4	2.18
0808S	-08	3/4-16	79,5	3.13	42,2	1.66	9,9	0.39	61,7	2.43
1008S	-08	7/8-14	85,9	3.38	48,5	1.91	9,9	0.39	65,3	2.57
1212S	-12	1 1/16-12	102,9	4.05	62,2	2.45	15,5	0.61	94,7	3.73
1616S	-16	1 5/16-12	119,1	4.69	65,0	2.56	20,8	0.82	116,3	4.58

Code 61 SAE J518 straight split flange

FC5075-

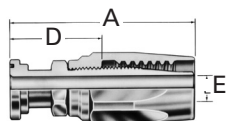

Dash size	Hose size	Thread	A		D		EØ	
			mm	in	mm	in	mm	in
FC5075-								
0808S	-08	1.19	76,5	3.01	39,1	1.54	9,9	0.39
1212S	-12	1.50	88,1	3.47	47,5	1.87	15,5	0.61
1616S	-16	1.75	114,3	4.50	60,5	2.38	20,8	0.82

¹SAE 100R2 pressures only.

For use with hose:
GH663¹

Hose fittings – Reusable

Braided hydraulic – one wire

100R1 TTC

ORS swivel straight

FJ9724-

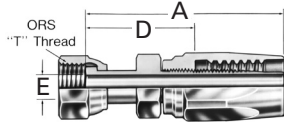

Dash size	Hose size	Thread	A		D		EØ	
			mm	in	mm	in	mm	in
FJ9724-								
0404S	-04	7/16-20	60,2	2.37	33,8	1.33	4,3	0.17
0404S	-04	9/16-18	66,5	2.62	40,1	1.58	4,1	0.16
0606S	-06	11/16-16	74,9	2.95	46,2	1.82	6,6	0.26
0808S	-08	13/16-16	85,9	3.38	48,5	1.91	9,1	0.36
1212S	-12	1 3/16-12	101,6	4.00	60,9	2.40	14,0	0.55
1616S	-16	1 7/16-12	117,9	4.64	63,8	2.51	19,8	0.78

ORS swivel 45° elbow

FJ9725-

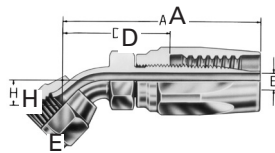

Dash size	Hose size	Thread	A		D		EØ		HØ	
			mm	in	mm	in	mm	in	mm	in
FJ9725-										
0404S	-04	9/16-18	63,0	2.48	36,6	1.44	4,3	0.17	10,4	0.41
0606S	-06	11/16-16	70,9	2.79	42,2	1.66	6,6	0.26	10,9	0.43
0808S	-08	13/16-16	83,3	3.28	46,0	1.81	9,7	0.38	15,0	0.59
1212S	-12	1 3/16-12	105,4	4.15	63,5	2.50	15,5	0.61	21,1	0.83
1616S	-16	1 7/16-12	120,9	4.76	67,1	2.64	20,6	0.81	23,9	0.94

ORS swivel 90° elbow short drop

FJ9726-

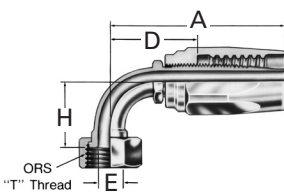

Dash size	Hose size	Thread	A		D		EØ		H	
			mm	in	mm	in	mm	in	mm	in
FC9726-										
0404S	-04	9/16-18	58,9	2.32	32,5	1.28	4,3	0.17	20,8	0.82
0606S	-06	11/16-16	67,3	2.65	38,6	1.52	6,6	0.26	22,9	0.90
0808S	-08	13/16-16	76,5	3.01	39,1	1.54	9,7	0.38	29,2	1.15
1212S	-12	1 3/16-12	102,9	4.05	62,2	2.45	15,5	0.61	47,8	1.88
1616S	-16	1 7/16-12	119,1	4.69	65,3	2.57	20,6	0.81	56,1	2.21

ORS swivel 90° elbow long drop

FJ9727-

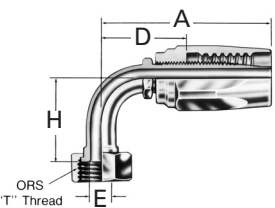

Dash size	Hose size	Thread	A		D		EØ		H	
			mm	in	mm	in	mm	in	mm	in
FJ9727-										
0404S	-04	9/16-18	58,9	2.32	32,5	1.28	4,3	0.17	45,7	1.80
0606S	-06	11/16-16	70,4	2.77	41,7	1.64	6,6	0.26	54,1	2.13
0808S	-08	13/16-16	79,5	3.13	42,2	1.66	9,7	0.38	63,8	2.51
1212S	-12	1 3/16-12	102,9	4.05	62,2	2.45	15,5	0.61	96,0	3.78
1616S	-16	1 7/16-12	119,1	4.69	65,3	2.57	20,6	0.81	114,3	4.50

30° swivel-metric threads special Komatsu

FJ7199-

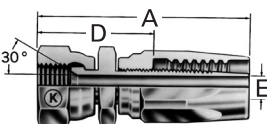

Dash size	Hose size	Thread	A		D		EØ	
			mm	in	mm	in	mm	in
FJ7199-								
0306S	-06	M18x1.5	77,2	3.04	48,3	1.90	6,4	0.25
0408S	-08	M22x1.5	83,8	3.30	46,2	1.82	9,4	0.37
0512S	-12	M24x1.5	98,0	3.86	57,4	2.26	12,2	0.48
0612S	-12	M30x1.5	102,1	4.02	61,5	2.42	15,5	0.61
1016S	-16	M33x1.5	119,9	4.72	65,8	2.59	20,3	0.80

Note: For correct socket part number, see page I-3.

For flanges, split flange halves, kits and o-rings, see page I-61-I-68.

¹SAE 100R1 pressures only. Correct to SAE 100R1 pressures only.

Hose fittings – Reusable

For use with hose:
FC310, FC510

Braided hydraulic – two wire

Hi-Pac fittings

Male pipe

FC5131-

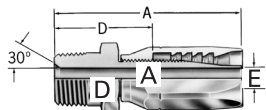

Dash size	Hose size	Thread	A		D		EØ	
			mm	in	mm	in	mm	in
FC5131-								
0404S	-04	1/4-18	62,5	2.46	31,5	1.24	4,3	0.17
0406S	-06	1/4-18	69,9	2.75	32,5	1.28	7,9	0.31
0606S	-06	3/8-18	69,9	2.75	32,5	1.28	7,9	0.31
0808S	-08	1/2-14	74,5	3.09	36,6	1.44	9,9	0.39
1212S	-12	3/4-14	91,7	3.61	44,2	1.74	15,5	0.61
1616S	-16	1-11 1/2	111,8	4.40	58,2	2.29	20,8	0.82
*2020S	-20	1 1/4-11 1/2	129,5	5.10	63,0	2.48	26,7	1.05

SAE 37° (JIC) swivel

FC5130-

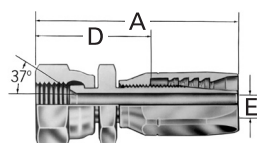

Dash size	Hose size	Thread	A		D		EØ	
			mm	in	mm	in	mm	in
FC5130-								
0404S	-04	7/16-20	66,0	2.60	35,1	1.38	4,3	0.17
0606S	-06	9/16-18	75,7	2.98	38,4	1.51	7,9	0.31
0806S	-06	3/4-16	79,0	3.11	41,7	1.64	7,9	0.31
0808S	-08	3/4-16	81,3	3.20	40,9	1.61	9,9	0.39
1008S	-08	7/8-14	84,1	3.31	45,7	1.80	9,9	0.39
1010S	-10	7/8-14	87,4	3.44	46,5	1.83	12,7	0.50
1212S	-12	1 1/16-12	98,0	3.86	50,5	1.99	15,5	0.61
1616S	-16	1 5/16-12	113,8	4.48	60,2	2.37	20,8	0.82
*2020S	-20	1 5/8-12	129,5	5.10	62,7	2.47	26,7	1.05

SAE 37° (JIC) male flare

FC5133-

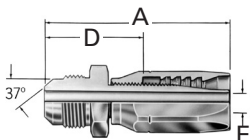

Dash size	Hose size	Thread	A		D		EØ	
			mm	in	mm	in	mm	in
FC5133-								
0404S	-04	7/16-20	62,0	2.44	31,2	1.23	4,3	0.17
0606S	-06	9/16-18	69,9	2.75	32,3	1.27	7,6	0.30
0806S	-06	3/4-16	73,9	2.91	36,3	1.43	7,9	0.31
0808S	-08	3/4-16	75,9	2.99	34,0	1.34	9,9	0.39
1008S	-08	7/8-14	78,7	3.10	36,6	1.44	9,9	0.39
1010S	-10	7/8-14	81,8	3.22	40,9	1.61	12,2	0.48
1212S	-12	1 1/16-12	94,5	3.72	47,0	1.85	15,5	0.61
1412S	-12	1 3/16-12	95,5	3.76	47,8	1.88	15,5	0.61
1616S	-16	1 5/16-12	111,3	4.38	57,7	2.27	20,8	0.82
*2020S	-20	1 5/8-12	124,0	4.88	62,7	2.47	26,7	1.05

¹FC310 only

Note: For correct socket part number, see page I-3.

Hi-Pac fittings

SAE male O-ring boss

FC5379[†]-

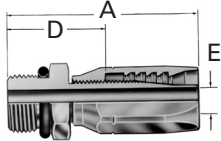

Dash size	Hose size	Thread	A		D		EØ	
			mm	in	mm	in	mm	in
FC5379-								
1008S	-08	7/8-14	72,1	2.84	30,2	1.19	9,9	0.39
1208S	-08	9/16-12	76,2	3.00	34,3	1.35	9,9	0.39
1616S	-16	1 5/16-12	99,8	3.93	46,2	1.82	20,8	0.82
*2020S	-20	1 5/8-12	111,3	4.38	50,8	1.98	26,7	1.05

[†]O-ring not included. For flanges, split flange halves, kits and o-rings, see page I-61–I-68.

SAE 37° (JIC) swivel 45° elbow

FC5144-

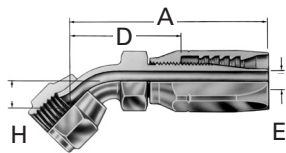

Dash size	Hose size	Thread	A		D		EØ		H	
			mm	in	mm	in	mm	in	mm	in
FC5144-										
0404S	-04	7/16-20	62,7	2.47	31,8	1.25	4,3	0.17	8,4	0.33
0606S	-06	9/16-18	71,6	2.82	34,3	1.35	7,9	0.31	9,9	0.39
0806S	-06	3/4-16	80,5	3.17	43,8	1.70	7,9	0.31	14,0	0.55
0808S	-08	3/4-16	83,8	3.30	43,9	1.73	9,9	0.39	14,0	0.55
1008S	-08	7/8-14	87,6	3.45	42,2	1.66	9,9	0.39	16,3	0.64
1010S	-10	7/8-20	89,9	3.54	50,5	1.99	12,7	0.50	16,3	0.64
1212S	-12	11/16-12	105,4	4.15	57,9	2.28	15,5	0.61	19,8	0.78
1616S	-16	1 5/16-12	127,8	5.03	74,2	2.92	20,8	0.82	27,2	1.07
*2020S	-20	1 5/8-12	149,1	5.87	87,9	3.46	26,7	1.05	31,0	1.22

SAE 37° (JIC) swivel 90° elbow (short)

FC5143-

SAE 37° (JIC) swivel 90° elbow (long)

FC5142-

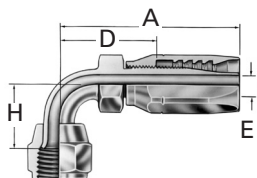

Dash size	Hose size	Thread	A		D		EØ		H	
			mm	in	mm	in	mm	in	mm	in
FC5143-										
0404S	-04	7/16-20	59,9	2.36	29,2	1.15	4,3	0.17	17,3	0.68
0606S	-06	9/16-18	69,1	2.72	31,8	1.25	7,9	0.31	21,6	0.85
0806S	-06	3/4-16	74,7	2.94	37,1	1.46	7,9	0.31	27,7	1.09
0808S	-08	3/4-16	76,7	3.02	35,1	1.38	9,9	0.39	27,7	1.09
1008S	-08	7/8-14	80,0	3.15	38,1	1.50	9,9	0.39	31,2	1.23
1010S	-10	7/8-14	83,3	3.28	42,4	1.67	12,7	0.50	31,2	1.23
1212S	-12	1 1/16-12	104,4	4.11	56,9	2.24	15,5	0.61	46,2	1.82
1616S	-16	1 5/16-12	122,9	4.84	69,3	2.73	20,8	0.82	60,7	2.39
*2020S	-20	1 5/8-12	144,0	5.67	83,1	3.27	26,7	1.05	69,9	2.75
FC5142-										
0404S	-04	7/16-20	59,9	2.36	29,2	1.15	4,3	0.17	45,7	1.80
0606S	-06	9/16-18	69,1	2.72	31,8	1.25	7,9	0.31	55,4	2.18
0806S	-06	3/4-16	77,7	3.06	40,3	1.59	7,9	0.31	61,7	2.43
0808S	-08	3/4-16	80,0	3.15	38,1	1.50	9,9	0.39	61,7	2.43
1008S	-08	7/8-14	86,4	3.40	44,5	1.75	9,9	0.39	65,3	2.57
1010S	-10	7/8-14	89,7	3.53	48,8	1.92	12,7	0.50	65,3	2.57
1212S	-12	1 1/16-12	104,4	4.11	56,9	2.24	15,5	0.61	94,7	3.73
1616S	-16	1 5/16-12	122,9	4.84	69,3	2.73	20,8	0.82	116,3	4.58
*2020S	-20	1 5/8-12	144,0	5.67	83,1	3.27	26,7	1.05	140,5	5.53

*FC310 only

Note: For correct socket part number, see page I-3.

Hose fittings – Reusable

For use with hose:
FC310, FC510

Braided hydraulic – two wire

Hi-Pac fittings

Lifesaver[†]
FC5380-

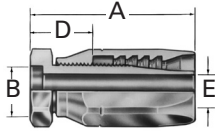

Dash size	Hose size	Thread	A		B†		D		EØ	
			mm	in	mm	in	mm	in	mm	in
FC5380-										
0404S	-04	1/4	50,5	1.99	6,4	0.25	19,6	0.77	4,3	0.17
0606S	-06	3/8	56,4	2.22	9,7	0.38	19,1	0.75	7,9	0.31
0808S	-08	1/2	60,9	2.40	12,7	0.50	19,1	0.75	9,9	0.39
1010S	-10	5/8	64,3	2.53	15,7	0.62	23,4	0.92	12,7	0.50
1212S	-12	3/4	72,6	2.86	19,1	0.75	25,1	0.99	15,5	0.61
1616S	-16	1	84,8	3.34	25,4	1.00	31,2	1.23	20,8	0.82
*2020S	-20	1 1/4	99,6	3.92	31,8	1.25	38,6	1.52	26,7	1.05

† "B" dimension is counterbore diameter for mating tubing.

Code 61 SAE J518 straight split flange

FC5135-

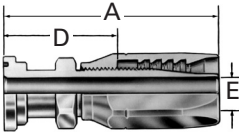

Dash size	Hose size	Flange head dia.		A		D		EØ	
		mm	in	mm	in	mm	in	mm	in
FC5135-									
0808S	-08	30,2	1.19	77,0	3.03	35,1	1.38	9,9	0.39
1208S	-08	38,1	1.50	78,0	3.07	36,1	1.42	9,9	0.39
1212S	-12	38,1	1.50	89,7	3.53	42,2	1.66	15,5	0.61
1612S	-12	44,5	1.75	99,6	3.92	52,1	2.05	15,5	0.61
1616S	-16	44,5	1.75	118,1	4.65	64,5	2.54	20,8	0.82
2016S	-16	50,8	2.00	118,1	4.65	64,5	2.54	20,8	0.82
*2020S	-20	50,8	2.00	132,8	5.23	71,9	2.83	26,7	1.05

Code 61 SAE J518
22 1/2° split flange

FC5136-

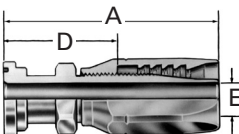

Dash size	Hose size	Flange head dia.		A		D		EØ		H	
		mm	in	mm	in	mm	in	mm	in	mm	in
FC5136-											
0808S	-08	30,2	1.19	95,5	3.76	53,6	2.11	9,9	0.39	12,7	0.50
1212S	-12	38,1	1.50	109,7	4.32	62,0	2.44	15,5	0.61	12,7	0.50
1612S	-12	44,5	1.75	109,7	4.32	62,0	2.44	15,5	0.61	12,7	0.50
1616S	-16	44,5	1.75	122,9	4.84	69,3	2.73	20,8	0.82	12,7	0.50
2016S	-16	50,8	2.00	122,9	4.84	69,3	2.73	20,8	0.82	12,7	0.50
*2020S	-20	50,8	2.00	138,9	5.47	78,0	3.07	26,7	1.05	12,7	0.50

Code 61 SAE J518
30° split flange

FC5137-

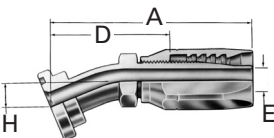

Dash size	Hose size	Flange head dia.		A		D		EØ		H	
		mm	in	mm	in	mm	in	mm	in	mm	in
FC5137-											
1212S	-12	38,1	1.50	111,3	4.38	63,8	2.51	15,5	0.61	17,5	0.69
1612S	-12	44,5	1.75	111,3	4.38	63,8	2.51	15,5	0.61	17,5	0.69
1616S	-16	44,5	1.75	117,1	4.61	63,5	2.50	20,8	0.82	12,7	0.50
2016S	-16	50,8	2.00	117,1	4.61	63,5	2.50	20,8	0.82	12,7	0.50
*2020S	-20	50,8	2.00	153,7	6.05	92,7	3.65	26,7	1.05	24,4	0.96

*FC310 only

Note: For correct socket part number, see page I-3.
For flanges, split flange halves, kits and o-rings, see page I-61–I-68.

Hi-Pac fittings

Code 61 SAE J518 45° split flange

FC5138-

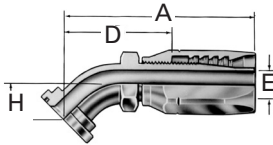

Dash size	Hose size	Flange head dia.		A		D		EØ		H	
		mm	in	mm	in	mm	in	mm	in	mm	in
FC5138-											
0808S	-08	30,2	1.19	94,2	3.71	52,3	2.06	9,9	0.39	25,4	1.00
1212S	-12	38,1	1.50	110,2	4.34	62,7	2.47	15,5	0.61	25,4	1.00
1612S	-12	44,5	1.75	111,5	4.39	64,0	2.52	15,5	0.61	25,4	1.00
1616S	-16	44,5	1.75	129,3	5.09	75,7	2.98	20,8	0.82	28,4	1.12
2016S	-16	50,8	2.00	129,3	5.09	75,7	2.98	20,8	0.82	28,4	1.12
*2020S	-20	50,8	2.00	146,6	5.77	85,6	3.37	26,7	1.05	28,4	1.12

Code 61 SAE J518 60° split flange

FC5139-

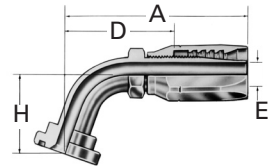

Dash size	Hose size	Flange head dia.		A		D		EØ		H	
		mm	in	mm	in	mm	in	mm	in	mm	in
FC5139-											
1212S	-12	38,1	1.50	114,8	4.52	67,3	2.65	15,5	0.61	41,1	1.62
1612S	-12	44,5	1.75	114,8	4.52	67,3	2.65	15,5	0.61	41,1	1.62
1616S	-16	44,5	1.75	130,8	5.15	77,2	3.04	20,8	0.82	41,7	1.64
2016S	-16	50,8	2.00	130,8	5.15	77,2	3.04	20,8	0.82	41,7	1.64
*2020S	-20	50,8	2.00	149,4	5.88	88,4	3.48	26,7	1.05	41,7	1.64

Code 61 SAE J518 67 1/2° split flange

FC5140-

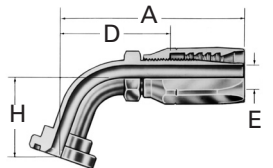

Dash size	Hose size	Flange head dia.		A		D		EØ		H	
		mm	in	mm	in	mm	in	mm	in	mm	in
FC5140-											
0808S	-08	30,2	1.19	88,1	3.47	46,2	1.82	9,9	0.39	35,1	1.38
1212S	-12	38,1	1.50	111,0	4.37	63,5	2.50	15,5	0.61	41,1	1.62
1612S	-12	44,5	1.75	111,0	4.37	63,5	2.50	15,5	0.61	41,1	1.62
1616S	-16	44,5	1.75	128,7	5.07	75,2	2.96	20,8	0.82	44,5	1.75
2016S	-16	50,8	2.00	128,7	5.07	75,2	2.96	20,8	0.82	44,5	1.75
*2020S	-20	50,8	2.00	149,1	5.87	87,9	3.46	26,7	1.05	47,8	1.88

Code 61 SAE J518 90° split flange

FC5141-

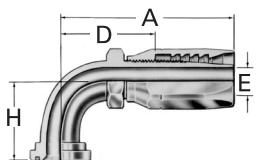

Dash size	Hose size	Flange head dia.		A		D		EØ		H	
		mm	in	mm	in	mm	in	mm	in	mm	in
FC5141-											
0808S	-08	30,2	1.19	80,0	3.15	38,1	1.50	9,9	0.39	41,1	1.62
1208S	-08	38,1	1.50	80,0	3.15	38,1	1.50	9,9	0.39	41,1	1.62
1212S	-12	38,1	1.50	104,4	4.11	56,9	2.24	15,5	0.61	53,8	2.12
1612S	-12	44,5	1.75	104,4	4.11	56,9	2.24	15,5	0.61	53,8	2.12
1616S	-16	44,5	1.75	122,9	4.84	69,3	2.73	20,8	0.82	60,5	2.38
2016S	-16	50,8	2.00	122,9	4.84	69,3	2.73	20,8	0.82	60,5	2.38
*2020S	-20	50,8	2.00	144,0	5.67	82,8	3.26	26,7	1.05	63,5	2.50

*FC310 only

Note: For correct socket part number, see page I-3.

For flanges, split flange halves, kits and o-rings, see page I-61–I-68.

Hose fittings – Reusable

For use with hose:
FC310, FC510

Braided hydraulic – two wire

Hi-Pac fittings

ORS swivel straight

FJ9728-

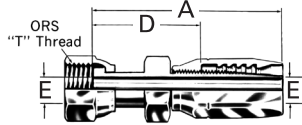

Dash size	Hose size	Flange head dia.	A		D		EØ	
			mm	in	mm	in	mm	in
FJ9728-								
0404S	-04	9/16-18	68,8	2.71	38,1	1.50	4,3	0.17
0606S	-06	11/16-16	76,7	3.02	39,4	1.55	6,6	0.26
0808S	-08	13/16-16	86,4	3.40	44,5	1.75	9,9	0.39
1010S	-10	1-14	91,9	3.62	51,1	2.01	12,7	0.50
1212S	-12	1 3/16-12	102,9	4.05	55,4	2.18	15,5	0.61
1616S	-16	1 7/16-12	121,4	4.78	68,1	2.68	20,8	0.82
*2020S	-20	1 11/16-12	134,6	5.30	73,7	2.90	26,7	1.05

ORS swivel 45° elbow

FJ9729-

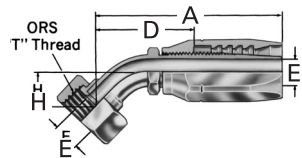

Dash size	Hose size	Flange head dia.	A		D		EØ		H	
			mm	in	mm	in	mm	in	mm	in
FJ9729-										
0404S	-04	9/16-18	65,5	2.58	34,5	1.36	3,8	0.15	10,4	0.41
0606S	-06	11/16-16	72,6	2.86	35,3	1.39	6,1	0.24	10,9	0.43
0808S	-08	13/16-16	83,8	3.30	41,9	1.65	9,4	0.37	15,0	0.59
1010S	-10	1-14	91,9	3.62	51,1	2.01	11,7	0.46	16,5	0.65
1212S	-12	1 3/16-12	106,9	4.21	59,4	2.34	14,7	0.58	21,1	0.83
1616S	-16	1 7/16-12	124,7	4.91	71,1	2.80	19,3	0.76	23,9	0.94
*2020S	-20	1 11/16-12	145,8	5.74	84,8	3.34	25,7	1.01	25,4	1.00

ORS swivel 90° elbow short drop

FJ9730-

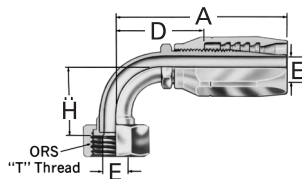

Dash size	Hose size	Flange head dia.	A		D		EØ		H	
			mm	in	mm	in	mm	in	mm	in
FJ9730-										
0404S	-04	9/16-18	61,5	2.42	30,7	1.21	3,8	0.15	20,8	0.82
0606S	-06	11/16-16	69,1	2.72	31,8	1.25	6,1	0.24	22,9	0.90
0808S	-08	13/16-16	76,7	3.02	35,1	1.38	9,4	0.37	29,2	1.15
1010S	-10	1-14	83,3	3.28	42,4	1.67	11,7	0.46	32,3	1.27
1212S	-12	1 3/16-12	104,4	4.11	56,9	2.24	14,7	0.58	47,8	1.88
1616S	-16	1 7/16-12	122,9	4.84	69,3	2.73	19,3	0.76	56,1	2.21
*2020S	-20	1 11/16-12	144,0	5.67	82,8	3.26	25,7	1.01	63,8	2.51

ORS swivel 90° elbow long drop

FJ9731-

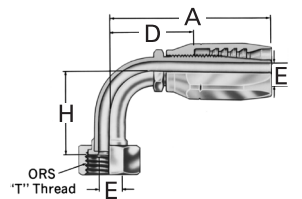

Dash size	Hose size	Flange head dia.	A		D		EØ		H	
			mm	in	mm	in	mm	in	mm	in
FJ9731-										
0404S	-04	9/16-18	61,5	2.42	30,7	1.21	3,8	0.15	45,7	1.80
0606S	-06	11/16-16	72,4	2.85	34,8	1.37	6,1	0.24	54,1	2.13
0808S	-08	13/16-16	80,0	3.15	38,1	1.50	9,4	0.37	63,8	2.51
1010S	-10	1-14	83,3	3.28	42,4	1.67	11,7	0.46	70,1	2.76
1212S	-12	1 3/16-12	104,4	4.11	56,9	2.24	14,7	0.58	96,0	3.78
1616S	-16	1 7/16-12	122,9	4.84	69,3	2.73	19,3	0.76	114,3	4.50
*2020S	-20	11 11/16-12	144,0	5.67	82,8	3.26	25,7	1.01	129,3	5.09

*FC310 only

Note: For correct socket part number, see page I-3.
For flanges, split flange halves, kits and o-rings, see page I-61–I-68.

Hi-Pac fittings

30° swivel-metric threads special komatsu

FJ7201-

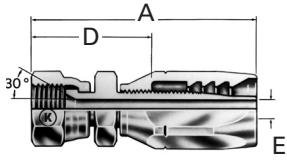

Dash size	Hose size	Thread	A		D		EØ	
			mm	in	mm	in	mm	in
FJ7201-								
0306S	-06	M18x1.5	79,0	3.11	41,7	1.64	6,4	0.25
0408S	-08	M22x1.5	84,3	3.32	42,2	1.66	9,4	0.37
0510S	-10	M24x1.5	90,9	3.58	50,0	1.97	12,7	0.50
0612S	-12	M30x1.5	103,6	4.08	56,4	2.22	15,5	0.61
1016S	-16	M33x1.5	123,4	4.86	70,1	2.76	20,3	0.80
1220S	-20	M36x1.5	138,7	5.46	77,7	3.06	24,1	0.95

Komatsu split flange

FJ7202-

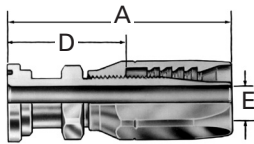

Dash size	Hose size	Flange head dia.		A		D		EØ	
		mm	in	mm	in	mm	in	mm	in
FJ7202-									
1010S	-10	34,3	1.35	114,8	4.52	73,9	2.91	11,7	0.46

Komatsu split flange 45° elbow

FJ7203-

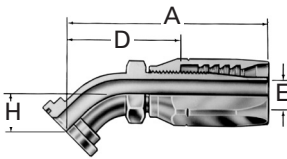

Dash size	Hose size	Flange head dia.		A		D		EØ		H	
		mm	in	mm	in	mm	in	mm	in	mm	in
FJ7203-											
1010S	-10	34,3	1.35	96,5	3.80	55,6	2.19	11,7	0.46	21,8	0.86

Komatsu split flange 90° elbow

FJ7204-

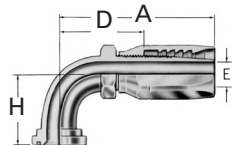

Dash size	Hose size	Flange head dia.		A		D		EØ		H	
		mm	in	mm	in	mm	in	mm	in	mm	in
FJ7204-											
1010S	-10	34,3	1.35	89,7	3.53	48,8	1.92	11,7	0.46	76,7	3.02

*FC310 only

Komatsu split flange fittings require the use of a special O-ring.

Note: For correct socket part number, see page I-3.

Hose fittings – Reusable

For use with hose:
2766, 2781¹, FC195¹

100R2 skive style

100R2 skive style

Male pipe

4722-

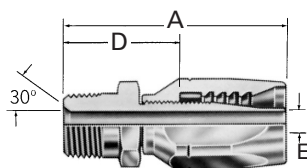

Dash size	Hose size	Thread	A		D		EØ	
			mm	in	mm	in	mm	in
4722-								
4-4S	-04	1/4-18	63,5	2.50	32,0	1.26	4,3	0.17
6-4S	-04	3/8-18	65,0	2.56	33,5	1.32	4,3	0.17
6-6S	-06	3/8-18	69,9	2.75	32,5	1.28	7,9	0.31
6-8S	-08	3/8-18	72,1	2.84	33,5	1.32	9,9	0.39
8-8S	-08	1/2-14	74,5	3.09	40,1	1.58	9,9	0.39
8-10S	-10	1/2-14	80,8	3.18	41,4	1.63	12,7	0.50
12-12S	-12	3/4-14	91,7	3.61	44,2	1.74	15,5	0.61
16-12S	-12	1-11 1/2	99,6	3.92	52,3	2.06	15,5	0.61
16-16S	-16	1-11 1/2	111,8	4.40	59,9	2.36	20,8	0.82
20-20S	-20	1 1/4-11 1/2	124,5	4.90	65,8	2.59	26,7	1.05
24-24S	-24	1 1/2-11 1/2	126,5	4.98	69,6	2.74	32,5	1.28
32-32S	-32	2-11 1/2	139,7	5.50	77,5	3.05	44,5	1.75

SAE 37° (JIC) swivel

4721

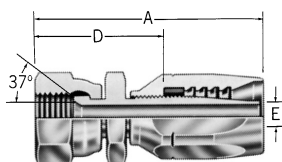

Dash size	Hose size	Thread	A		D		EØ	
			mm	in	mm	in	mm	in
4721								
4-4S	-04	7/16-20	67,1	2.64	35,8	1.41	4,3	0.17
5-4S	-04	1 1/2-20	69,1	2.72	37,8	1.49	4,3	0.17
6-4S	-04	9/16-18	70,9	2.79	39,6	1.56	4,3	0.17
6-6S	-06	9/16-18	75,7	2.98	38,4	1.51	6,6	0.26
8-6S	-06	3/4-16	79,0	3.11	41,4	1.63	7,9	0.31
8-8S	-08	3/4-16	81,3	3.20	42,7	1.68	9,9	0.39
10-8S	-08	7/8-14	84,1	3.31	45,7	1.80	9,9	0.39
12-8S	-08	1 1/16-12	86,4	3.40	48,0	1.89	9,9	0.39
10S	-10	7/8-14	86,4	3.40	47,0	1.85	12,7	0.50
12-10S	-10	1 1/16-12	88,9	3.50	49,3	1.94	12,7	0.50
12S	-12	1 1/16-12	98,0	3.86	50,5	1.99	15,5	0.61
14-12S	-12	1 3/16-12	100,1	3.94	52,3	2.06	15,5	0.61
16-12S	-12	1 5/16-12	101,6	4.00	54,1	2.13	15,5	0.61
16S	-16	1 5/16-12	113,8	4.48	61,7	2.43	20,8	0.82
20S	-20	1 5/8-12	129,5	5.10	70,6	2.78	26,7	1.05
24S	-24	1 7/8-12	131,1	5.16	74,4	2.93	32,5	1.28
32S	-32	2 1/2-12	149,9	5.90	88,1	3.47	44,5	1.75

¹SAE 100R2 pressures only.

Note: For correct socket part number, see page I-3.

For how to assemble, see section A

100R2 skive style

SAE 37° (JIC) swivel

4721-
316 stainless steel
259-4721-

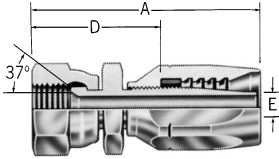

Dash size	Hose size	Thread	A		D		EØ	
			mm	in	mm	in	mm	in
259-4721-								
4-4	-04	7/16-20	67,1	2.64	35,8	1.41	4,3	0.17
6-4	-04	9/16-18	70,9	2.79	39,6	1.56	4,3	0.17
6-6	-06	9/16-18	75,7	2.98	38,4	1.51	6,6	0.26
8-6	-06	3/4-16	79,0	3.11	41,7	1.64	7,9	0.31
8-8	-08	3/4-16	81,3	3.20	42,7	1.68	9,9	0.39
10-8	-08	7/8-14	84,1	3.31	45,7	1.80	9,9	0.39
10	-10	7/8-14	86,4	3.40	47,0	1.85	12,7	0.50
12	-12	1 1/16-12	98,0	3.86	50,5	1.99	15,5	0.61
16	-16	1 5/16-12	113,8	4.48	61,5	2.42	20,8	0.82

SAE O-ring boss male

190464†

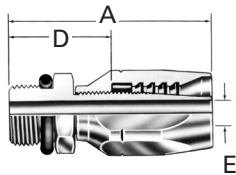

Dash size	Hose size	Thread	A		D		EØ	
			mm	in	mm	in	mm	in
190464-								
8S	-08	3/4-16	68,8	2.71	30,5	1.20	9,9	0.39
10-8S	-08	7/8-14	72,1	2.84	33,8	1.33	9,9	0.39
12-8S	-08	1 1/16-12	76,2	3.00	37,8	1.49	9,9	0.39
12S	-12	1 1/16-12	87,9	3.46	40,3	1.59	15,5	0.61
14-12S	-12	1 3/16-12	87,9	3.46	40,3	1.59	15,5	0.61
16S	-16	1 5/16-12	99,8	3.93	47,5	1.87	20,8	0.82
20S	-20	1 5/8-12	111,8	4.40	52,6	2.07	26,7	1.05
24S	-24	1 7/8-12	109,5	4.31	52,6	2.07	32,5	1.28
32S	-32	2 1/2-12	118,9	4.68	56,6	2.23	44,5	1.75

†O-ring not included. See page I-63 for O-Rings.

SAE 37° (JIC) male flare

4725-

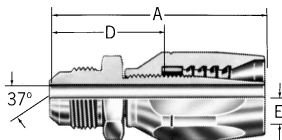

Dash size	Hose size	Thread	A		D		EØ	
			mm	in	mm	in	mm	in
4725-								
4-4S	-4	7/16-20	63,2	2.49	31,8	1.25	4,3	0.17
5-4S	-4	1/2-20	63,2	2.49	31,8	1.25	4,3	0.17
6-4S	-4	9/16-18	64,8	2.55	33,8	1.33	4,3	0.17
6-6S	-6	9/16-18	69,9	2.75	32,5	1.28	7,6	0.30
8-6S	-6	3/4-16	73,9	2.91	36,6	1.44	7,9	0.31
8-8S	-8	3/4-16	75,9	2.99	37,6	1.48	9,9	0.39
10-8S	-8	7/8-14	78,7	3.10	40,3	1.59	9,9	0.39
10S	-10	7/8-14	81,0	3.19	41,7	1.64	13,0	0.51
12-8S	-8	1 1/16-12	82,8	3.26	44,5	1.75	9,9	0.39
12-10S	-10	1 1/16-12	85,3	3.36	46,0	1.81	12,7	0.50
12S	-12	1 1/16-12	94,5	3.72	47,0	1.85	15,5	0.61
14-12S	-12	1 3/16-12	95,5	3.76	47,8	1.88	15,5	0.61
16-12S	-12	1 5/16-12	99,1	3.90	51,6	2.03	15,5	0.61
16S	-16	1 5/16-12	111,3	4.38	59,2	2.33	20,8	0.82
20S	-12	1 5/8-12	124,2	4.89	65,5	2.58	26,7	1.05
24S	-24	1 7/8-12	128,5	5.06	71,6	2.82	32,5	1.28

†O-ring not included. See I-63 for O-Rings.

¹SAE 100R2 pressures only.

Note: For correct socket part number, see page I-3.

Hose fittings – Reusable

For use with hose:
2766, 2781¹, FC195¹

100R2 skive style

100R2 skive style

Lifesaver*
191000-

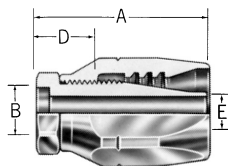

Dash size	Hose size	Tube	A		D		EØ		H	
			mm	in	mm	in	mm	in	mm	in
191000-										
4S	-04	1/4	51,6	2.03	6,4	0.25	20,3	0.80	4,3	0.17
6S	-06	3/8	56,4	2.22	9,7	0.38	19,1	0.75	7,9	0.31
8-6S	-06	1/2	58,9	2.32	12,7	0.50	21,3	0.84	7,9	0.31
8S	-08	1/2	60,9	2.40	12,7	0.50	22,6	0.89	9,9	0.39
10-8S	-08	5/8	60,9	2.40	15,7	0.62	22,6	0.89	9,9	0.39
10S	-10	5/8	63,5	2.50	15,7	0.62	23,9	0.94	12,7	0.50
12S	-12	3/4	72,6	2.86	19,1	0.75	25,1	0.99	15,5	0.61
16-12S	-12	1	72,6	2.86	25,4	1.00	25,1	0.99	15,5	0.61
16S	-16	1	84,8	3.34	25,4	1.00	32,8	1.29	20,8	0.82
20-16S	-16	1 1/4	87,9	3.46	31,8	1.25	36,1	1.42	20,8	0.82
24-16S	-16	1 1/2	89,7	3.53	38,1	1.50	37,6	1.48	20,8	0.82
16-20S	-20	1	100,1	3.94	25,4	1.00	41,1	1.62	20,8	0.82
20-20S	-20	1 1/4	100,1	3.94	31,8	1.25	41,1	1.62	26,7	1.05
24-20S	-20	1 1/2	101,6	4.00	38,1	1.50	42,7	1.68	26,7	1.05
20-24S	-24	1 1/4	99,3	3.91	31,8	1.25	42,7	1.68	26,7	1.05
24S	-24	1 1/2	99,3	3.91	38,1	1.50	42,7	1.68	32,5	1.28
32S	-32	2	110,2	4.34	50,8	2.00	41,7	1.64	44,5	1.75

SAE 37° (JIC) swivel
45° elbow
190287-

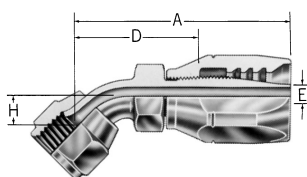

Dash size	Hose size	Thread	A		D		EØ		H	
			mm	in	mm	in	mm	in	mm	in
190287-										
4S	-04	7/16-20	63,8	2.51	32,5	1.28	4,3	0.17	8,4	0.33
6S	-06	9/16-18	71,6	2.82	34,3	1.35	7,9	0.31	9,9	0.39
8-6S	-06	3/4-16	80,5	3.17	43,8	1.70	7,9	0.31	14,0	0.55
8S	-08	3/4-16	82,8	3.26	44,5	1.75	9,9	0.39	14,0	0.55
10-8S	-08	7/8-14	87,6	3.45	49,3	1.94	9,9	0.39	16,3	0.64
10S	-10	7/8-14	89,9	3.54	50,5	1.99	12,7	0.50	16,3	0.64
12S	-12	1 1/16-12	105,4	4.15	57,9	2.28	15,5	0.61	19,8	0.78
16S	-16	1 5/16-12	127,8	5.03	75,4	2.97	20,8	0.82	27,2	1.07
20S	-20	1 5/8-12	149,4	5.88	90,4	3.56	26,7	1.05	31,0	1.22

Also available with metric and jump size counterbores.
¹SAE 100R2 pressures only.

Note: For correct socket part number, see page I-3.

100R2 skive style

SAE 37° (JIC) swivel

90° Elbow (Short)
190264-

90° Elbow (Long)
190263-

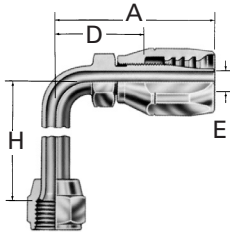

Dash size	Hose size	Thread	A		D		EØ		H	
			mm	in	mm	in	mm	in	mm	in
190264-										
4S	-04	7/16-20	60,9	2.40	29,7	1.17	4,3	0.17	17,3	0.68
6S	-06	9/16-18	69,1	2.72	31,8	1.25	7,9	0.31	21,6	0.85
8-6S	-06	3/4-16	74,7	2.94	37,1	1.46	7,9	0.31	27,7	1.09
8S	-08	3/4-16	76,7	3.02	38,6	1.52	9,9	0.39	27,7	1.09
10-8S	-08	7/8-14	80,0	3.15	41,7	1.64	9,9	0.39	31,2	1.23
10S	-10	7/8-14	82,3	3.24	42,9	1.69	12,7	0.50	31,2	1.23
12S	-12	1 1/16-12	104,4	4.11	56,9	2.24	15,5	0.61	46,2	1.82
16S	-16	1 5/16-12	122,9	4.84	70,9	2.79	20,8	0.82	60,7	2.39
20S	-20	1 5/8-12	144,3	5.68	85,3	3.36	26,7	1.05	69,9	2.75
190263-										
4S	-04	7/16-20	60,9	2.40	29,7	1.17	4,3	0.17	45,7	1.80
6S	-06	9/16-18	69,1	2.72	31,8	1.25	7,9	0.31	55,4	2.18
8-6S	-06	3/4-16	77,7	3.06	40,3	1.59	7,9	0.31	61,7	2.43
8S	-08	3/4-16	80,0	3.15	41,7	1.64	9,9	0.39	61,7	2.43
10-8S	-08	7/8-14	86,4	3.40	48,0	1.89	9,9	0.39	65,3	2.57
10S	-10	7/8-14	88,9	3.50	49,3	1.94	12,7	0.50	65,3	2.57
12S	-12	1 1/16-12	104,4	4.11	56,9	2.24	15,5	0.61	94,7	3.73
16S	-16	1 5/16-12	122,9	4.84	70,6	2.78	20,8	0.82	116,3	4.58
20S	-20	1 5/8-12	144,3	5.68	85,3	3.36	26,7	1.05	140,5	5.53

Code 61 SAE J518 straight split flange

4744-

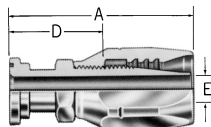

Dash size	Hose size	Flange head Dia.		A		D		EØ		
		mm	in	mm	in	mm	in	mm	in	
4744-										
8S	-08	30,2	1.19	77,0	3.03	38,6	1.52	9,9	0.39	
12-8S	-08	38,1	1.50	78,0	3.07	39,6	1.56	9,9	0.39	
12S	-12	38,1	1.50	89,7	3.53	42,2	1.66	15,5	0.61	
16-12S	-12	44,5	1.75	99,6	3.92	52,1	2.05	15,5	0.61	
16S	-16	44,5	1.75	118,1	4.65	65,8	2.59	20,8	0.82	
20-16S	-16	50,8	2.00	118,1	4.65	66,0	2.60	20,8	0.82	
24-16S	-16	60,5	2.38	119,9	4.72	67,6	2.66	20,8	0.82	
16-20S	-20	44,5	1.75	142,5	5.61	83,6	3.29	20,8	0.82	
20S	-20	50,8	2.00	133,4	5.25	74,4	2.93	26,7	1.05	
24-20S	-20	60,5	2.38	133,4	5.25	74,4	2.93	26,7	1.05	
24S	-24	60,5	2.38	140,0	5.51	83,1	3.27	32,5	1.28	
20-24S	-24	50,8	2.00	132,6	5.22	75,9	2.99	26,7	1.05	
32-24S	-24	71,4	2.81	140,0	5.51	83,1	3.27	32,5	1.28	
32S	-32	71,4	2.81	161,8	6.37	99,8	3.93	44,5	1.75	

For flanges, split flange halves, kits and o-rings, see page I-61–I-68.

¹SAE 100R2 pressures only.

Note: For correct socket part number, see page I-3.

Hose fittings – Reusable

For use with hose:
2766, 2781¹, FC195¹

100R2 skive style

100R2 skive style

Code 61 SAE J518
22 1/2" split flange

4720-

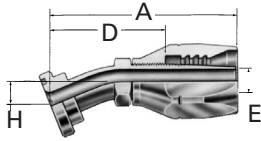

Dash size	Hose size	Flange head Dia.		A		D		EØ		H	
		mm	in	mm	in	mm	in	mm	in	mm	in
4720-											
8S	-08	30,2	1.19	95,5	3.76	57,2	2.25	9,9	0.39	12,7	0.50
12S	-12	38,1	1.50	107,2	4.22	62,0	2.44	15,5	0.61	12,7	0.50
16-12S	-12	44,5	1.75	109,7	4.32	62,0	2.44	15,5	0.61	12,7	0.50
16S	-16	44,5	1.75	122,9	4.84	70,9	2.79	20,8	0.82	12,7	0.50
20-16S	-16	50,8	2.00	122,9	4.84	70,9	2.79	20,8	0.82	12,7	0.50
20S	-20	50,8	2.00	139,4	5.49	80,5	3.17	26,7	1.05	12,7	0.50
24S	-24	60,5	2.38	140,2	5.52	83,3	3.28	32,5	1.28	12,7	0.50
32S	-32	71,4	2.81	153,4	6.04	91,4	3.60	44,5	1.75	12,7	0.50

Code 61 SAE J518
30° split flange

190414-

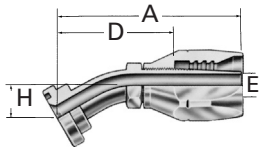

Dash size	Hose size	Flange head Dia.		A		D		EØ		H	
		mm	in	mm	in	mm	in	mm	in	mm	in
190414-											
12S	-12	38,1	1.50	111,3	4.38	63,8	2.51	15,5	0.61	17,5	0.69
16-12S	-12	44,5	1.75	111,3	4.38	63,8	2.51	15,5	0.61	17,5	0.69
20-12S	-12	50,8	2.00	111,3	4.38	63,8	2.51	15,5	0.61	17,5	0.69
16S	-16	44,5	1.75	117,1	4.61	65,0	2.56	20,8	0.82	12,7	0.50
20-16S	-16	50,8	2.00	117,1	4.61	65,0	2.56	20,8	0.82	12,7	0.50
16-20S	-20	44,5	1.75	153,9	6.06	95,0	3.74	26,7	1.05	24,4	0.96
20S	-20	50,8	2.00	153,9	6.06	95,0	3.74	26,7	1.05	24,4	0.96
24-20S	-20	60,5	2.38	153,9	6.06	95,0	3.74	26,7	1.05	24,4	0.96
32-20S	-20	71,4	2.81	155,4	6.12	96,5	3.80	26,7	1.05	25,1	0.99
20-24S	-24	50,8	2.00	153,4	6.04	96,7	3.81	26,7	1.05	24,4	0.96
24S	-24	60,5	2.38	138,4	5.45	81,8	3.22	32,5	1.28	14,7	0.58
32-24S	-24	71,4	2.81	138,4	5.45	81,8	3.22	32,5	1.28	14,7	0.58
32S	-32	71,4	2.81	155,7	6.13	93,7	3.69	44,5	1.75	16,5	0.65

¹SAE 100R2 pressures only.

Note: For flanges, split flange halves, kits and o-rings, see page I-61–I-68.
For socket part numbers, see page I-3.

100R2 skive style

Code 61 SAE J518
45° split flange
4745-

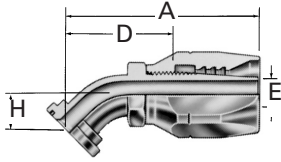

Dash size	Hose size	Flange head Dia.		A		D		EØ		H	
		mm	in	mm	in	mm	in	mm	in	mm	in
4745-											
8S	-08	30,2	1.19	94,2	3.71	55,9	2.20	9,9	0.39	25,4	1.00
12-8S	-08	38,1	1.50	94,2	3.71	55,9	2.20	9,9	0.39	25,4	1.00
16-10S	-10	44,5	1.75	99,3	3.91	59,7	2.35	12,7	0.50	25,4	1.00
12S	-12	38,1	1.50	110,2	4.34	62,7	2.47	15,5	0.61	25,4	1.00
16-12S	-12	44,5	1.75	111,5	4.39	64,0	2.52	15,5	0.61	25,4	1.00
20-12S	-12	50,8	2.00	111,3	4.38	64,0	2.52	15,5	0.61	25,4	1.00
24-12S	-12	60,5	2.38	113,0	4.45	65,0	2.56	15,5	0.61	26,7	1.05
32-12S	-12	71,4	2.81	111,0	4.37	63,5	2.50	15,5	0.61	25,1	0.99
16S	-16	44,5	1.75	129,3	5.09	77,2	3.04	20,8	0.82	28,4	1.12
20-16S	-16	50,8	2.00	129,3	5.09	77,2	3.04	20,8	0.82	28,4	1.12
24-16S	-16	60,5	2.38	130,3	5.13	78,2	3.08	20,8	0.82	29,7	1.17
16-20S	-20	44,5	1.75	144,3	5.68	85,3	3.36	20,8	0.82	28,4	1.12
20S	-20	50,8	2.00	146,8	5.78	87,9	3.46	26,7	1.05	28,4	1.12
24-20S	-20	60,5	2.38	146,8	5.78	87,9	3.46	26,7	1.05	28,4	1.12
32-20S	-20	71,4	2.81	148,1	5.83	89,2	3.51	26,7	1.05	29,7	1.17
20-24S	-24	50,8	2.00	146,3	5.76	89,7	3.53	26,7	1.05	28,4	1.12
24S	-24	60,5	2.38	149,1	5.87	92,2	3.63	32,5	1.28	28,4	1.12
32-24S	-24	71,4	2.81	148,8	5.86	92,2	3.63	32,5	1.28	28,4	1.12
32S	-32	71,4	2.81	168,4	6.63	106,4	4.19	44,5	1.75	31,8	1.25
40-32S	-32	84,1	3.31	169,4	6.67	107,4	4.23	44,5	1.75	33,0	1.30

Code 61 SAE J518
67 1/2° split flange
4767-

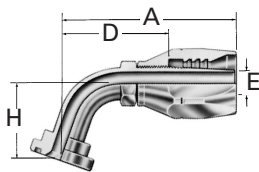

Dash size	Hose size	Flange head Dia.		A		D		EØ		H	
		mm	in	mm	in	mm	in	mm	in	mm	in
4767-											
8S	-08	30,2	1.19	88,1	3.47	49,8	1.96	9,9	0.39	35,1	1.38
12S	-12	38,1	1.50	111,0	4.37	63,5	2.50	15,5	0.61	41,1	1.62
16-12S	-12	44,5	1.75	111,0	4.37	63,5	2.50	15,5	0.61	41,1	1.62
16S	-16	44,5	1.75	128,7	5.07	76,7	3.02	20,8	0.82	44,5	1.75
20-16S	-16	50,8	2.00	128,7	5.07	76,7	3.02	20,8	0.82	44,5	1.75
20S	-20	50,8	2.00	149,4	5.88	90,4	3.56	26,7	1.05	47,8	1.88
24S	-24	60,5	2.38	154,4	6.08	97,5	3.84	32,5	1.28	50,8	2.00
32S	-32	71,4	2.81	176,3	6.94	114,3	4.50	44,5	1.75	57,2	2.25

¹SAE 100R2 pressures only.

Note: For flanges, split flange halves, kits and o-rings, see page I-61–I-68.
For socket part numbers, see page I-3.

Hose fittings – Reusable

For use with hose:
2766, 2781¹, FC195¹

100R2 skive style

100R2 skive style

Code 61 SAE J518
90° split flange

4790-

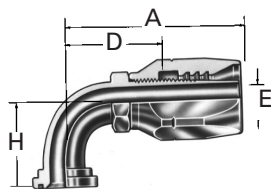

Dash size	Hose size	Flange head Dia.		A		D		EØ		H	
		mm	in	mm	in	mm	in	mm	in	mm	in
4790-											
8S	-08	30,2	1.19	80,0	3.15	41,7	1.64	9,9	0.39	41,1	1.62
12-8S	-08	38,1	1.50	80,0	3.15	41,7	1.64	9,9	0.39	41,1	1.62
16-8S	-08	44,5	1.75	80,0	3.15	41,7	1.64	9,9	0.39	45,2	1.78
12-10S	-10	38,1	1.50	88,9	3.50	49,3	1.94	12,7	0.50	51,6	2.03
16-10S	-10	44,5	1.75	88,9	3.50	49,3	1.94	12,7	0.50	53,8	2.12
8-12S	-12	30,2	1.19	91,7	3.61	44,2	1.74	9,4	0.37	41,1	1.62
12S	-12	38,1	1.50	104,4	4.11	56,9	2.24	15,5	0.61	53,8	2.12
16-12S	-12	44,5	1.75	104,4	4.11	56,9	2.24	15,5	0.61	53,8	2.12
20-12S	-12	50,8	2.00	104,4	4.11	56,9	2.24	15,5	0.61	53,8	2.12
24-12S	-12	60,5	2.38	104,4	4.11	56,9	2.24	15,5	0.61	56,4	2.22
12-16S	-16	38,1	1.50	116,6	4.59	64,5	2.54	20,8	0.82	53,8	2.12
16S	-16	44,5	1.75	122,9	4.84	70,9	2.79	20,8	0.82	60,5	2.38
20-16S	-16	50,8	2.00	122,9	4.84	70,9	2.79	20,8	0.82	60,5	2.38
24-16S	-16	60,5	2.38	122,9	4.84	70,9	2.79	20,8	0.82	62,0	2.44
32-16S	-16	71,4	2.81	122,9	4.84	70,9	2.79	20,8	0.82	59,4	2.34
16-20S	-20	44,5	1.75	138,2	5.44	79,2	3.12	20,8	0.82	60,5	2.38
20S	-20	50,8	2.00	144,3	5.68	85,3	3.36	26,7	1.05	63,5	2.50
24-20S	-20	60,5	2.38	144,3	5.68	85,3	3.36	26,7	1.05	63,5	2.50
32-20S	-20	71,4	2.81	144,3	5.68	85,3	3.36	26,7	1.05	65,0	2.56
20-24S	-24	50,8	2.00	143,8	5.66	86,9	3.42	26,7	1.05	63,5	2.50
24S	-24	60,5	2.38	150,1	5.91	93,5	3.68	32,5	1.28	69,9	2.75
32-24S	-24	71,4	2.81	150,1	5.91	93,5	3.68	32,5	1.28	69,9	2.75
32S	-32	71,4	2.81	173,7	6.84	111,8	4.40	44,5	1.75	82,6	3.25
40-32S	-32	84,1	3.31	173,7	6.84	111,8	4.40	44,5	1.75	84,1	3.31

ORS swivel straight

FJ9732-

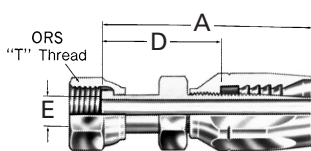

Dash size	Hose size	Thread	A		D		EØ	
			mm	in	mm	in	mm	in
FJ9732-								
0404S	-04	9/16-18	69,9	2.75	38,6	1.52	4,3	0.17
0606S	-06	11/16-16	76,7	3.02	39,4	1.55	6,6	0.26
0808S	-08	13/16-16	86,4	3.40	48,0	1.89	9,9	0.39
1010S	-10	1-14	90,9	3.58	51,6	2.03	12,7	0.50
1212S	-12	1 3/16-12	102,9	4.05	55,4	2.18	15,5	0.61
1616S	-16	1 7/16-12	121,4	4.78	69,3	2.73	20,8	0.82
2020S	-20	1 11/16-12	135,1	5.32	76,2	3.00	26,7	1.05
2424S	-24	2-12	135,9	5.35	79,2	3.12	32,0	1.26

¹ SAE 100R2 pressures only.

Note: For flanges, split flange halves, kits and o-rings, see page I-61–I-68.
For socket part numbers, see page I-3.

100R2 skive style

ORS swivel 45° elbow

FJ9733-

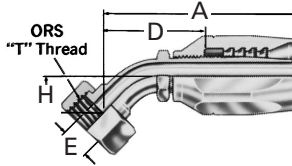

Dash size	Hose size	"T" Thread	A		D		EØ		H	
			mm	in	mm	in	mm	in	mm	in
FJ9733-										
0404S	-04	9/16-18	66,5	2.62	35,3	1.39	3,8	0.15	10,4	0.41
0606S	-06	11/16-16	72,6	2.86	35,3	1.39	6,1	0.24	10,9	0.43
0808S	-08	13/16-16	83,8	3.30	45,5	1.79	9,4	0.37	15,0	0.59
1010S	-10	1-14	91,2	3.59	51,6	2.03	11,7	0.46	16,5	0.65
1212S	-12	1 3/16-12	106,9	4.21	59,4	2.34	14,7	0.58	21,1	0.83
1616S	-16	1 7/16-12	124,7	4.91	72,4	2.85	19,3	0.76	23,9	0.94
2020S	-20	1 11/16-12	146,3	5.76	87,4	3.44	25,7	1.01	25,4	1.00
2424S	-24	2-12	147,6	5.81	90,9	3.58	32,0	1.26	27,2	1.07

ORS swivel 90° elbow short drop

FJ9734-

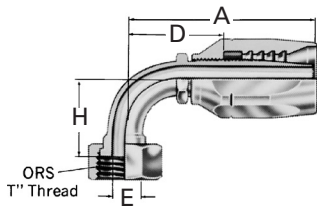

Dash size	Hose size	"T" Thread	A		D		EØ		H	
			mm	in	mm	in	mm	in	mm	in
FJ9734-										
0404S	-04	9/16-18	62,7	2.47	31,2	1.23	3,8	0.15	20,8	0.82
0606S	-06	11/16-16	69,1	2.72	31,8	1.25	6,1	0.24	22,9	0.90
0808S	-08	13/16-16	76,7	3.02	38,6	1.52	9,4	0.37	29,2	1.15
1010S	-10	1-14	82,3	3.24	42,9	1.69	11,7	0.46	32,3	1.27
1212S	-12	1 3/16-12	104,4	4.11	56,9	2.24	14,7	0.58	47,8	1.88
1616S	-16	1 7/16-12	122,9	4.84	70,6	2.78	19,3	0.76	56,1	2.21
2020S	-20	1 11/16-12	144,3	5.68	85,3	3.36	25,7	1.01	63,8	2.51
2424S	-24	2-12	150,1	5.91	93,5	3.68	32,0	1.26	68,6	2.70

ORS swivel 90° elbow long drop

FJ9735-

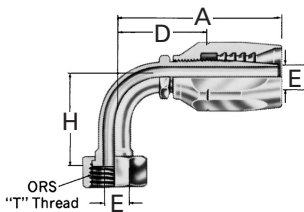

Dash size	Hose size	"T" Thread	A		D		EØ		H	
			mm	in	mm	in	mm	in	mm	in
FJ9735-										
0404S	-04	9/16-18	66,5	2.62	35,3	1.39	3,8	0.15	45,7	1.80
0606S	-06	11/16-16	72,4	2.85	34,8	1.37	6,1	0.24	54,1	2.13
0808S	-08	13/16-16	80,0	3.15	41,7	1.64	9,4	0.37	63,8	2.51
1010S	-10	1-14	82,3	3.24	42,9	1.69	11,7	0.46	70,1	2.76
1212S	-12	1 3/16-12	104,4	4.11	56,9	2.24	14,7	0.58	96,0	3.78
1616S	-16	1 7/16-12	122,9	4.84	70,6	2.78	19,3	0.76	114,3	4.50
2020S	-20	1 11/16-12	144,3	5.68	85,3	3.36	25,7	1.01	129,3	5.09
2424S	-24	2-12	150,1	5.91	93,5	3.68	32,0	1.26	140,7	5.54

¹ SAE 100R2 pressures only.

¹ Approved to 100R2 pressures only.

Note: For socket part numbers, see page I-3.

For flanges, split flange halves, kits and o-rings, see page I-61–I-68.

Hose fittings – Reusable

For use with hose:
2766, 2781¹, FC195¹

100R2 skive style

100R2 skive style

BSP male

07.020-

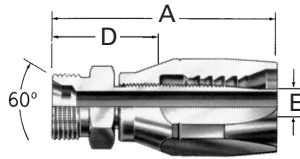

Dash size	Hose size	Thread	A		D		EØ	
			mm	in	mm	in	mm	in
07.020-								
4-4	-04	1/4-19	62.5	2.46	31	1.22	4.0	0.16
6-6	-06	3/8-19	69	2.72	31.5	1.24	8.0	0.31
8-8	-08	1/2-14	73	2.87	34.5	1.36	10.0	0.39
10-10	-10	5/8-14	78.5	3.09	39	1.54	13.0	0.51
12-10	-10	3/4-14	79.5	3.13	40	1.57	13.0	0.51
12-12	-12	3/4-14	89	3.50	41.5	1.63	15.5	0.61
16-12	-12	1-11	92.5	3.64	45	1.77	15.5	0.61
16-16	-16	1-11	104.5	4.11	52.5	2.07	20.5	0.81
20-20	-20	1 1/4-11	116.5	4.59	57.5	2.26	26.5	1.04
24-24	-24	1 1/2-11	115.5	4.55	58.5	2.30	32.5	1.28
32-32	-32	2-11	130.5	5.14	68.5	2.70	44.5	1.75

BSP female swivel

07.420-

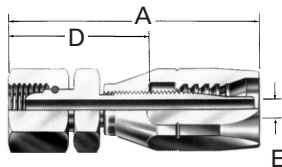

Dash size	Hose size	Thread	A		D		EØ	
			mm	in	mm	in	mm	in
07.420-								
4-4	-04	1/4-19	69	2.72	37.5	1.48	4.0	0.16
6-6	-06	3/8-19	75.5	2.97	38	1.50	8.0	0.31
8-6	-06	1/2-14	77	3.03	39.5	1.56	8.0	0.31
8-8	-08	1/2-14	79	3.11	40.5	1.59	10.0	0.39
10-8	-08	5/8-14	80.5	3.17	42	1.65	10.0	0.39
10-10	-10	5/8-14	83	3.27	43.5	1.71	13.0	0.51
12-10	-10	3/4-14	84.5	3.33	45	1.77	13.0	0.51
12-12	-12	3/4-14	94	3.70	46.5	1.83	15.5	0.61
16-12	-12	1-11	99	3.90	51.5	2.03	15.5	0.61
16-16	-16	1-11	111	4.37	59	2.32	20.5	0.81
20-16	-16	1 1/4-11	112	4.41	60	2.36	20.5	0.81
20-20	-20	1 1/4-11	124	4.88	65	2.56	26.5	1.04
24-24	-24	1 1/2-11	125	4.92	68.5	2.70	32.5	1.28
32-32	-32	2-11	138	5.43	76.1	3.00	44.5	1.75

¹Approved to 100R2 pressures only.

Note: For correct socket part number, see page I-3.

100R2 skive style

Male 60° DIN 7631/7647

07.078-

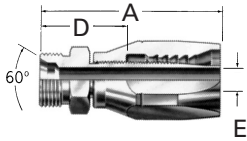

Dash size	Hose size	Thread	A		D		EØ	
			mm	in	mm	in	mm	in
07.078-								
4-4	-04	M12 x 1.5	61,0	2.40	29,5	1.16	4,0	0.16
6-4	-04	M14 x 1.5	61,0	2.40	29,5	1.16	4,0	0.16
8-6	-06	M16 x 1.5	66,0	2.60	28,5	1.12	8,0	0.31
10-6	-06	M18 x 1.5	66,0	2.60	28,5	1.12	8,0	0.31
13-8	-08	M22 x 1.5	70,0	2.76	31,5	1.24	10,0	0.39
16-10	-10	M26 x 1.5	72,5	2.85	33,0	1.30	13,0	0.51
20-12	-12	M30 x 1.5	84,0	3.31	36,5	1.44	15,5	0.61
25-16	-16	M38 x 1.5	98,0	3.86	46,0	1.81	20,5	0.81
32-20	-20	M45 x 1.5	110,0	4.33	51,0	2.01	26,5	1.04
40-24	-24	M52 x 1.5	110,0	4.33	53,0	2.09	32,5	1.28
50-32	-32	M65 x 2	122,0	4.80	60,0	2.36	44,5	1.75

Male 24° DIN 3901/3902 I.Rh

07.013-

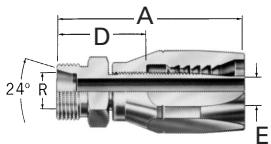

Dash size	Hose size	Thread	A		D		EØ		RØ	
			mm	in	mm	in	mm	in	mm	in
07.013-										
6-4	-04	M12 x 1.5	61,0	2.40	29,5	1.16	4,0	0.16	6,0	0.24
8-4	-04	M14 x 1.5	61,0	2.40	29,5	1.16	4,0	0.16	8,0	0.31
10-6	-06	M16 x 1.5	67,0	2.64	29,5	1.16	8,0	0.31	10,0	0.39
12-6	-06	M18 x 1.5	77,0	2.64	29,5	1.16	8,0	0.31	12,0	0.47
15-8	-08	M22 x 1.5	70,0	2.76	31,5	1.24	10,0	0.39	15,0	0.59
18-10	-10	M26 x 1.5	72,5	2.85	33,0	1.30	13,0	0.51	18,0	0.71
22-12	-12	M30 x 2	86,0	3.39	38,5	1.52	15,5	0.61	22,0	0.87
28-16	-16	M36 x 2	98,0	3.86	46,0	1.81	20,5	0.81	28,0	1.10
35-20	-20	M45 x 2	112,0	4.41	53,0	2.09	26,5	1.04	35,0	1.38
42-24	-24	M52 x 2	112,0	4.41	55,0	2.17	32,5	1.28	42,0	1.65

Male 24° DIN 3901/3902 s.Rh

07.005-

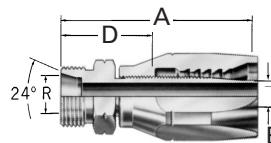

Dash size	Hose size	Thread	A		D		EØ		RØ	
			mm	in	mm	in	mm	in	mm	in
07.005-										
8-4	-04	M16 x 1.5	63,0	2.48	31,5	1.24	4,0	0.16	8,0	0.31
10-4	-04	M18 x 1.5	63,0	2.48	31,5	1.24	4,0	0.16	10,0	0.39
12-6	-06	M20 x 1.5	68,0	2.68	30,5	1.20	8,0	0.31	12,0	0.47
14-6	-06	M22 x 1.5	70,0	2.76	32,5	1.28	8,0	0.31	14,0	0.55
16-8	-08	M24 x 1.5	70,0	2.83	33,5	1.32	10,0	0.39	16,0	0.63
20-10	-10	M30 x 2	72,0	3.09	39,0	1.54	13,0	0.51	20,0	0.79
25-12	-12	M36 x 2	90,0	3.54	42,5	1.67	15,5	0.61	25,0	0.98
30-16	-16	M42 x 2	104,0	4.09	52,0	2.05	20,5	0.81	30,0	1.18
38-20	-20	M52 x 2	120,0	4.72	59,0	2.32	26,5	1.04	38,0	1.50

*Rf dimension is tube O.D. and refers to mating component when not called out on the illustration.
¹SAE 100R2 pressures only.

Note: For correct socket part number, see page I-3.

Hose fittings – Reusable

For use with hose:
2766, 2781¹, FC195¹

100R2 skive style

100R2 skive style

Female swivel 60° DIN 7631/7647

07.357-

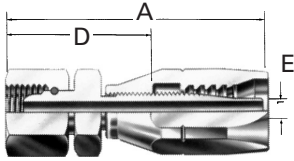

Dash size	Hose size	Thread	A		D		EØ	
			mm	in	mm	in	mm	in
07.357-								
20-12	-12	M30 x 1.5	93,5	3.68	46,0	1.81	15,5	0.61
25-16	-16	M38 x 1.5	108,0	4.25	56,0	0.20	20,5	0.81
32-20	-20	M45 x 1.5	122,0	4.80	63,0	2.48	26,5	1.04
40-24	-24	M52 x 1.5	119,5	4.70	62,5	2.46	32,5	1.28
50-32	-32	M65 x 2	133,5	5.26	71,5	2.81	44,5	1.75

*Rf dimension is tube O.D. and refers to mating component when not called out on the illustration.

Note: For correct socket part number, see page I-3.

¹SAE 100R2 pressures only.

Female swivel 24° DIN 3901/3902 I.Rh.

07.327-

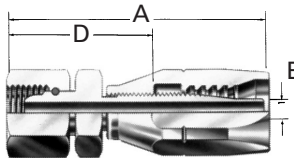

Dash size	Hose size	Thread	A		D		EØ		H	
			mm	in	mm	in	mm	in	mm	in
07.327-										
4-4†	-04	M12 x 1.5	67,0	2.64	35,5	1.40	4,0	0.16	6,0	0.24
6-4†	-04	M14 x 1.5	67,0	2.64	35,5	1.40	4,0	0.16	8,0	0.31
8-6†	-06	M16 x 1.5	73,5	2.89	36,0	1.42	8,0	0.31	10,0	0.39
10-6†	-06	M18 x 1.5	73,5	2.89	36,0	1.42	8,0	0.31	12,0	0.47
13-8†	-08	M22 x 1.5	77,5	3.05	39,0	1.54	10,0	0.39	15,0	0.59
16-8†	-08	M26 x 1.5	80,5	3.17	42,0	1.65	10,0	0.39	18,0	0.71
16-10†	-10	M26 x 1.5	83,0	3.27	43,5	1.71	13,0	0.51	18,0	0.71
22-12	-12	M30 x 2	95,0	3.74	47,5	1.87	15,5	0.61	22,0	0.87
28-16	-16	M36 x 2	108,5	4.27	56,5	2.22	20,5	0.81	28,0	1.10
35-20	-20	M45 x 2	121,5	4.78	62,5	2.46	26,5	1.04	35,0	1.38
42-24	-24	M52 x 2	122,0	4.80	65,0	2.56	32,5	1.28	42,0	1.65

Female swivel 24° DIN 3901/3902 s.Rh.

07.721-

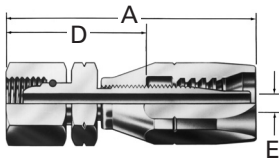

Dash size	Hose size	Thread	A		D		EØ		H	
			mm	in	mm	in	mm	in	mm	in
07.721-										
8-4	-04	M16 x 1.5	68,5	2.70	37,0	1.46	4,0	0.16	8,0	0.31
10-4	-04	M18 x 1.5	68,5	2.70	37,0	1.46	4,0	0.16	10,0	0.39
12-6	-06	M20 x 1.5	75,5	2.97	38,0	1.50	8,0	0.31	12,0	0.47
14-6	-06	M22 x 1.5	75,5	2.97	38,0	1.50	8,0	0.31	14,0	0.55
16-8	-08	M24 x 1.5	79,5	3.13	41,0	1.61	10,0	0.39	16,0	0.63
20-10	-10	M30 x 2	85,5	3.37	46,0	1.81	13,0	0.51	20,0	0.79
20-12	-12	M30 x 2	95,0	3.74	47,5	1.87	15,5	0.61	20,0	0.79
25-12	-12	M36 x 2	96,0	3.78	48,5	1.91	15,5	0.61	25,0	0.98
30-16	-16	M42 x 2	109,0	4.29	57,0	2.24	20,5	0.81	30,0	1.18
38-20	-20	M52 x 2	122,0	4.80	63,0	2.48	26,5	1.04	38,0	1.50

†Universal fitting also mates with DIN 7631/7647 60° connection

*Rø dimension is tube O.D. and refers to mating component when not called out on the illustration.

¹SAE 100R2 pressures only.

Komatsu split flange fittings require the use of a special o-ring.

Note: For correct socket part number, see page I-3..

100R2 skive style

30° swivel-metric threads special Komatsu

FC5432-

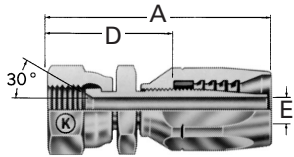

Dash size	Hose size	Thread	A		D		EØ	
			mm	in	mm	in	mm	in
FC5432-								
0306S	-06	M18 x 1.5	79,0	3.11	41,7	1.64	6,4	0.25
0408S	-08	M22 x 1.5	84,3	3.32	45,7	1.80	9,4	0.37
0510S	-10	M24 x 1.5	90,2	3.55	50,8	2.00	12,7	0.50
0612S	-12	M30 x 1.5	103,6	4.08	56,1	2.21	15,5	0.61
1016S	-16	M33 x 1.5	123,7	4.87	71,4	2.81	20,8	0.82
1220S	-20	M36 x 1.5	139,2	5.48	80,0	3.15	24,1	0.95
1424S	-24	M42 x 1.5	140,2	5.52	83,6	3.29	30,2	1.19

Komatsu split flange

FJ9066-

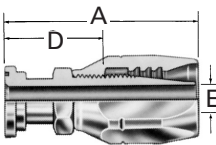

Dash size	Hose size	Thread	A		D		EØ	
			mm	in	mm	in	mm	in
FJ9066-								
1010S	-10	34,3 1.35	113,8	4.48	74,4	2.93	11,7	0.46

Komatsu split flange 45° elbow

FJ9065-

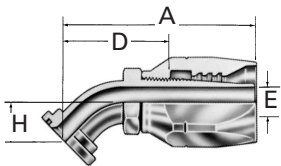

Dash size	Hose size	Thread	A		D		EØ		H	
			mm	in	mm	in	mm	in	mm	in
FJ9065-										
1010S	-10	34,3 1.35	95,8	3.77	56,4	2.22	11,7	0.46	21,8	0.86

Komatsu split flange 90° elbow

FJ9064-

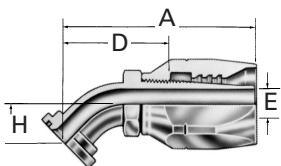

Dash size	Hose size	Thread	A		D		EØ		H	
			mm	in	mm	in	mm	in	mm	in
FJ9064-										
1010S	-10	34,3 1.35	88,9	3.50	49,3	1.94	11,7	0.46	51,3	2.02

†Universal fitting also mates with DIN 7631/7647 60° connection

*Rø dimension is tube O.D. and refers to mating component when not called out on the illustration.

¹SAE 100R2 pressures only.

Komatsu split flange fittings require the use of a special o-ring.

Note: For correct socket part number, see page I-3.

Hose fittings – Reusable

For use with hose:
GH793¹

100R2 TTC

100R2 TTC

Male pipe

FC5985-

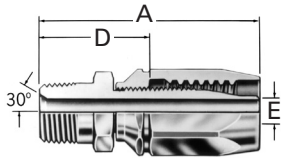

Dash size	Hose size	Thread	A		D		E Ø	
			mm	in	mm	in	mm	in
FC5985-								
0404S	-04	1/4-18	63,5	2.50	33,8	1.33	4,3	0.17
0606S	-06	3/8-18	69,9	2.75	35,8	1.41	7,9	0.31
0608S	-08	3/8-18	72,1	2.84	33,3	1.31	9,9	0.39
0808S	-08	1/2-14	74,5	3.09	40,1	1.58	9,9	0.39
1212S	-12	3/4-14	91,7	3.61	44,2	1.74	15,5	0.61
1616S	-16	1-11 1/2	111,8	4.40	59,7	2.35	20,8	0.82

SAE 37° (JIC) swivel

FC5988-

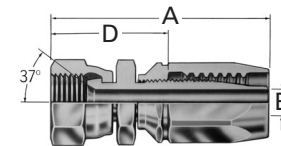

Dash size	Hose size	Thread	A		D		E Ø	
			mm	in	mm	in	mm	in
FC5988-								
0404S	-04	7/16-20	67,1	2.64	37,3	1.47	4,3	0.17
0606S	-06	9/16-18	75,7	2.98	41,7	1.64	7,9	0.31
0808S	-08	3/4-16	81,3	3.20	42,7	1.68	9,9	0.39
1212S	-12	11/16-12	98,0	3.86	50,5	1.99	15,5	0.61
1616S	-16	15/16-12	113,8	4.48	61,7	2.43	20,8	0.82

SAE 37° (JIC) male flare

FC5986-

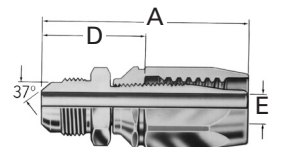

Dash size	Hose size	Thread	A		D		E Ø	
			mm	in	mm	in	mm	in
FC5986-								
0404S	-04	7/16-20	63,2	2.49	33,5	1.32	4,3	0.17
0606S	-06	9/16-18	69,9	2.75	35,8	1.41	7,6	0.30
0808S	-08	3/4-16	75,9	2.99	37,6	1.48	9,9	0.39
1212S	-12	1 1/16-12	94,5	3.72	47,0	1.85	15,5	0.61
1616S	-16	1 5/16-12	111,3	4.38	59,2	2.33	20,8	0.82

SAE male O-ring boss**

FC5987-

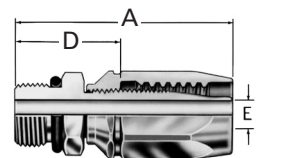

Dash size	Hose size	Thread	A		D		E Ø	
			mm	in	mm	in	mm	in
FC5987-								
0606S	-06	9/16-18	65,5	2.58	31,5	1.24	7,9	0.31
0806S	-06	3/4-16	66,8	2.63	32,8	1.29	7,9	0.31
0808S	-08	3/4-16	68,8	2.71	30,5	1.20	9,9	0.39
1212S	-12	1 1/16-12	87,9	3.46	40,3	1.59	15,5	0.61
1616S	-16	1 5/16-12	99,8	3.93	47,8	1.88	20,8	0.82

Lifesaver*

FC5989-

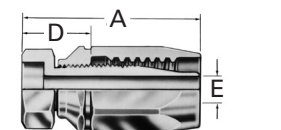

Dash size	Hose size	Tube size	A		B*		D		E Ø	
			mm	in	mm	in	mm	in	mm	in
FC5989-										
0404S	-04	1/4	51,6	2.03	6,4	0.25	21,8	0.86	4,3	0.17
0606S	-06	3/8	56,4	2.22	9,7	0.38	22,4	0.88	7,9	0.31
0808S	-08	1/2	60,9	2.40	12,7	0.50	22,6	0.89	9,9	0.39
1212S	-12	3/4	72,6	2.86	19,1	0.75	25,1	0.99	15,5	0.61
1616S	-16	1	84,8	3.34	25,4	1.00	32,8	1.29	20,8	0.82

¹SAE 100R2 pressures only.

*B dimension is counterbore diameter for mating tubing.

**See page I-63 for o-rings.

Note: For socket part numbers, see page I-3.

100R2 TTC

SAE 37° (JIC) swivel 45° elbow
FC5990-

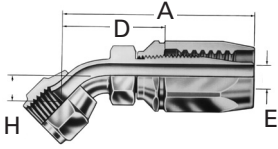

Dash size	Hose size	Thread	A		D		EØ		H	
			mm	in	mm	in	mm	in	mm	in
FC5990-										
0404S	-04	7/16-20	63,8	2.51	34,0	1.34	4,3	0.17	8,4	0.33
0606S	-06	9/16-18	71,6	2.82	37,6	1.48	7,9	0.31	9,9	0.39
0808S	-08	3/4-16	82,8	3.26	44,5	1.75	9,9	0.39	14,0	0.55
1212S	-12	1 1/16-12	105,4	4.15	57,9	2.28	15,5	0.61	19,8	0.78
1616S	-16	1 5/16-12	127,8	5.03	75,7	2.98	20,8	0.82	27,2	1.07

SAE 37° (JIC) swivel
90° elbow (short)

FC5992-

90° elbow (long)

FC5991-

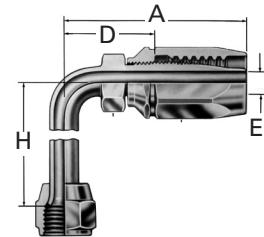

Dash size	Hose size	Thread	A		D		EØ		H	
			mm	in	mm	in	mm	in	mm	in
FC5992-										
4-4	-	-	-	-	-	-	-	-	-	-
0404S	-04	7/16-20	60,9	2.40	31,2	1.23	4,3	0.17	17,3	0.68
0606S	-06	9/16-18	69,1	2.72	35,1	1.38	7,9	0.31	21,6	0.85
0808S	-08	3/4-16	76,7	3.02	38,6	1.52	9,9	0.39	27,7	1.09
1212S	-12	1 1/16-12	104,4	4.11	56,9	2.24	15,5	0.61	46,2	1.82
1616S	-16	1 5/16-12	122,9	4.84	70,9	2.79	20,8	0.82	60,7	2.39
FC5991-										
0404S	-04	7/16-20	60,9	2.40	31,2	1.23	4,3	0.17	45,7	1.80
0606S	-06	9/16-18	69,1	2.72	35,1	1.38	7,9	0.31	55,4	2.18
0808S	-08	3/4-16	80,0	3.15	41,7	1.64	9,9	0.39	61,7	2.43
1212S	-12	1 1/16-12	104,4	4.11	56,9	2.24	15,5	0.61	94,7	3.73
1616S	-16	1 5/16-12	122,9	4.84	70,9	2.79	20,8	0.82	116,3	4.58

Code 61 SAE J518 straight
split flange

FC5993-

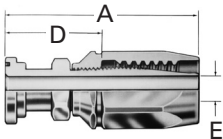

Dash size	Hose size	A		D		EØ	
		mm	in	mm	in	mm	in
FC5993-							
0808S	-08	77,0	3.03	38,6	1.52	9,9	0.39
1212S	-12	89,7	3.53	42,2	1.66	15,5	0.61
1616S	-16	118,1	4.65	66,0	2.60	20,8	0.82

ORS swivel straight

FJ7344-

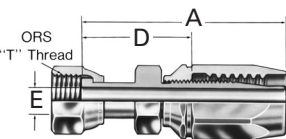

Dash size	Hose size	"T" Thread	A		D		EØ	
			mm	in	mm	in	mm	in
FJ7344-								
0404S	-04	9/16-18	70,1	2.76	40,3	1.59	4,1	0.16
0606S	-06	11/16-16	77,0	3.03	42,9	1.69	6,6	0.26
0808S	-08	13/16-16	86,4	3.40	48,0	1.89	9,1	0.36
1212S	-12	1 3/16-12	103,1	4.06	59,9	2.36	14,0	0.55
1616S	-16	1 7/16-12	121,7	4.79	69,6	2.74	19,8	0.78

For flanges, split flange halves, kits and o-rings, see page I-61–I-68.

¹SAE 100R2 pressures only.

For correct socket part number, see page I-3.

Hose fittings – Reusable

For use with hose:
GH793¹

100R2 TTC

100R2 TTC

ORS swivel 45° elbow
FJ7345-

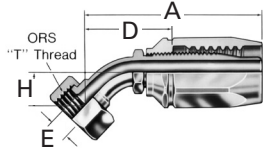

Dash size	Hose size	"T" Thread	A		D		EØ		H	
			mm	in	mm	in	mm	in	mm	in
FJ7345-										
0404S	-04	9/16-18	66,5	2.62	36,8	1.45	4,3	0.17	10,4	0.41
0606S	-06	11/16-16	72,9	2.87	38,9	1.53	6,6	0.26	10,9	0.43
0808S	-08	13/16-16	83,8	3.30	45,5	1.79	9,7	0.38	15,0	0.59
1212S	-12	1 3/16-12	106,9	4.21	59,4	2.34	15,5	0.61	21,1	0.83
1616S	-16	1 7/16-12	124,7	4.91	72,6	2.86	20,6	0.81	23,9	0.94

ORS swivel 90° elbow short drop
FJ7346-

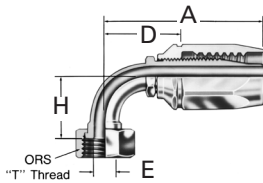

Dash size	Hose size	"T" Thread	A		D		EØ		H	
			mm	in	mm	in	mm	in	mm	in
FJ7346-										
0404S	-04	9/16-18	62,7	2.47	33,0	1.30	4,3	0.17	20,8	0.82
0606S	-06	11/16-16	69,1	2.72	35,1	1.38	6,6	0.26	22,9	0.90
0808S	-08	13/16-16	77,0	3.03	38,6	1.52	9,7	0.38	29,2	1.15
1212S	-12	1 3/16-12	104,4	4.11	56,9	2.24	15,5	0.61	47,8	1.88
1616S	-16	1 7/16-12	122,9	4.84	70,9	2.79	20,6	0.81	56,1	2.21

ORS swivel 90° elbow long drop
FJ7347-

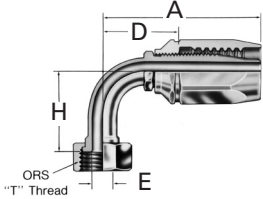

Dash size	Hose size	"T" Thread	A		D		EØ		H	
			mm	in	mm	in	mm	in	mm	in
FJ7347-										
0404S	-04	9/16-18	62,7	2.47	33,0	1.30	4,3	0.17	45,7	1.80
0606S	-06	11/16-16	72,4	2.85	38,4	1.51	6,6	0.26	54,1	2.13
0808S	-08	13/16-16	80,0	3.15	41,7	1.64	9,7	0.38	63,8	2.51
1212S	-12	1 3/16-12	104,4	4.11	56,9	2.24	15,5	0.61	96,0	3.78
1616S	-16	1 7/16-12	122,9	4.84	70,9	2.79	20,6	0.81	114,3	4.50

30° swivel-metric threads special Komatsu
FJ7200-

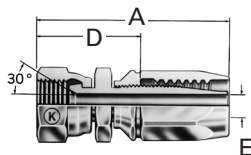

Dash size	Hose size	"T" Thread	A		D		EØ	
			mm	in	mm	in	mm	in
FJ7200-								
0306S	-06	M18x1.5	79,0	3.11	45,0	1.77	6,4	0.25
0408S	-08	M22x1.5	84,3	3.32	45,7	1.80	9,4	0.37
0512S	-12	M24x1.5	99,6	3.92	52,3	2.06	12,2	0.48
0612S	-12	M30x1.5	103,6	4.08	56,4	2.22	15,5	0.61
1016S	-16	M33x1.5	123,4	4.86	71,6	2.82	20,3	0.80

¹SAE 100R2 pressures only.

Note: For socket part number, see page I-3.

Spiral skive style fittings

Male pipe

190934-
FC7640-

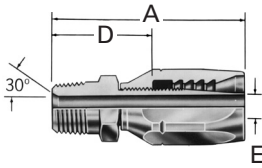

Dash size	Hose size	Thread	A		D		EØ	
			mm	in	mm	in	mm	in
190934-								
4-6S	-06	1/4-18	78,0	3.07	36,8	1.45	7,6	0.30
6-6S	-06	3/8-18	78,0	3.07	36,8	1.45	7,6	0.30
6-8S	-08	3/8-18	72,1	2.84	33,8	1.33	9,9	0.39
8-8S	-08	1/2-14	74,5	3.09	40,1	1.58	9,9	0.39
12-12S	-12	3/4-14	91,7	3.61	44,2	1.74	15,5	0.61
16-16S	-16	1-11 1/2	111,8	4.40	59,7	2.35	20,8	0.82
FC7640-								
2020S	-20	1 1/4-11 1/2	138,2	5.44	62,0	2.44	26,7	1.05
2424S	-24	1 1/2-11 1/2	146,3	5.76	71,6	2.82	32,5	1.28

SAE 37° (JIC) swivel

190933-
FC7639-

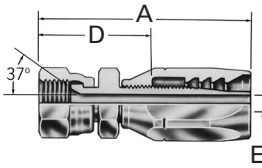

Dash size	Hose size	Thread	A		D		EØ	
			mm	in	mm	in	mm	in
190933-								
6-6S	-06	9/16-18	83,8	3.30	42,7	1.68	7,6	0.30
8-6S	-06	3/4-16	87,1	3.43	46,0	1.81	7,6	0.30
8-8S	-08	3/4-16	81,3	3.20	42,7	1.68	9,9	0.39
10-8S	-08	7/8-14	84,1	3.31	45,7	1.80	9,9	0.39
12S	-12	1 1/16-12	98,0	3.86	50,5	1.99	15,5	0.61
16S	-16	1 5/16-12	113,8	4.48	61,7	2.43	20,8	0.82
FC7639-								
2020S	-20	1 5/8-12	143,3	5.64	67,1	2.64	26,7	1.05
2424S	-24	1 7/8-12	154,4	6.08	79,5	3.13	32,5	1.28

SAE 37° (JIC) male flare

190992-
FC7740-

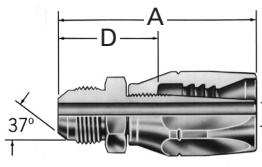

Dash size	Hose size	Thread	A		D		EØ	
			mm	in	mm	in	mm	in
190992-								
8-8S	-08	3/4-16	75,9	2.99	37,6	1.48	9,9	0.39
10-8S	-08	7/8-14	78,7	3.10	40,1	1.58	9,9	0.39
12S	-12	1 1/16-12	94,5	3.72	47,0	1.85	15,5	0.61
16S	-16	1 5/16-12	111,3	4.38	59,2	2.33	20,8	0.82
FC7740-								
2020S	-20	1 5/8-12	137,9	5.43	61,7	2.43	26,7	1.05
2424S	-24	1 7/8-12	148,6	5.85	73,7	2.90	32,5	1.28

SAE 37° (JIC) swivel 22 1/2° elbow

FC5978-
FC5979-

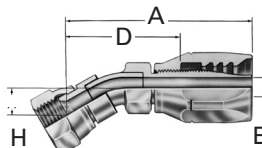

Dash size	Hose size	Thread	A		D		EØ		H	
			mm	in	mm	in	mm	in	mm	in
FC5978-										
0808S	-08	3/4-16	102,4	4.03	64,0	2.52	9,9	0.39	11,9	0.47
1212S	-12	1 1/16-12	119,9	4.72	72,4	2.85	15,5	0.61	13,2	0.52
1616S	-16	1 5/16-12	147,1	5.79	95,0	3.74	20,8	0.82	17,5	0.69
FC5979-										
2020S	-20	1 5/8-12	185,9	7.32	109,7	4.32	26,7	1.05	20,3	0.80
2424S	-24	1 7/8-12	211,3	8.32	136,4	5.37	32,5	1.28	24,1	0.95

Note: For socket part numbers, see page I-3.

Hose fittings – Reusable

For use with hose:
GH493, FC736

Spiral hose

Spiral skive style fittings

SAE 37° (JIC) swivel 30° elbow

FC5980-
FC5981-

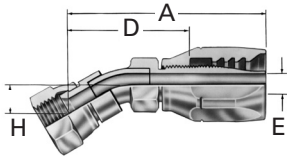

Dash size	Hose size	Thread	A		D		EØ		H	
			mm	in	mm	in	mm	in	mm	in
FC5980-										
0808S	-08	3/4-16	101,1	3.98	62,7	2.47	9,9	0.39	15,7	0.62
1212S	-12	1 1/16-12	118,1	4.65	70,6	2.78	15,5	0.61	17,5	0.69
1616S	-16	1 5/16-12	148,8	5.86	96,5	3.80	20,8	0.82	24,1	0.95
FC5981-										
2020S	-20	1 5/8-12	189,5	7.46	113,3	4.46	26,7	1.05	28,2	1.11
2424S	-24	1 7/8-12	213,1	8.39	138,2	5.44	32,5	1.28	32,8	1.29

SAE 37° (JIC) swivel 45° elbow

FC5982-
FC5983-

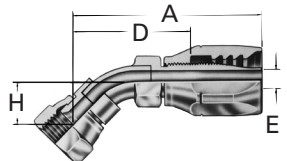

Dash size	Hose size	Thread	A		D		EØ		H	
			mm	in	mm	in	mm	in	mm	in
FC5982-										
0808S	-08	3/4-16	100,3	3.95	62,0	2.44	9,9	0.39	24,1	0.95
1212S	-12	1 1/16-12	123,7	4.87	76,2	3.00	15,5	0.61	29,5	1.16
1616S	-16	1 5/16-12	152,4	6.00	100,1	3.94	20,8	0.82	38,9	1.53
FC5983-										
2020S	-20	1 5/8-12	188,5	7.42	112,2	4.42	26,7	1.05	43,8	1.70
2424S	-24	1 7/8-12	212,9	8.38	137,9	5.43	32,5	1.28	50,5	1.99

SAE 37° (JIC) swivel 60° elbow

FC5984-
FJ9024-

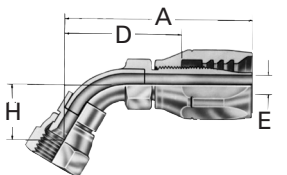

Dash size	Hose size	Thread	A		D		EØ		H	
			mm	in	mm	in	mm	in	mm	in
FC5984-										
0808S	-08	3/4-16	97,5	3.84	59,2	2.33	9,9	0.39	32,0	1.26
1212S	-12	1 1/16-12	123,2	4.85	75,7	2.98	15,5	0.61	40,6	1.60
1616S	-16	1 5/16-12	149,9	5.90	97,5	3.84	20,8	0.82	52,8	2.08
FJ9024-										
2020S	-20	1 5/8-12	186,9	7.36	110,7	4.36	26,7	1.05	59,2	2.33
2424S	-24	1 7/8-12	210,1	8.27	135,1	5.32	32,5	1.28	68,8	2.71

SAE 37° (JIC) swivel 67 1/2° elbow

FJ9025-
FJ9026-

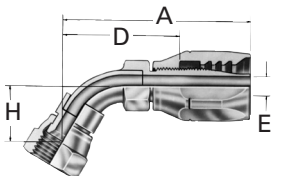

Dash size	Hose size	Thread	A		D		EØ		H	
			mm	in	mm	in	mm	in	mm	in
FJ9025-										
0808S	-08	3/4-16	98,0	3.86	59,7	2.35	9,9	0.39	37,3	1.47
1212S	-12	1 1/16-12	121,4	4.78	73,9	2.91	15,5	0.61	45,7	1.80
1616S	-16	1 5/16-12	148,3	5.84	96,0	3.78	20,8	0.82	59,9	2.36
FJ9026-										
2020S	-20	1 5/8-12	183,9	7.24	107,7	4.24	26,7	1.05	66,5	2.62
2424S	-24	1 7/8-12	195,6	7.70	120,7	4.75	32,5	1.28	70,1	2.76

Note: For socket part numbers, see page I-3.

Spiral skive style fittings

SAE 37° (JIC) swivel
90° elbow

FJ9027-
FJ9028-

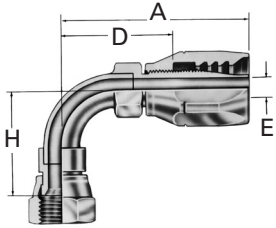

Dash size	Hose size	Thread	A		D		EØ		H	
			mm	in	mm	in	mm	in	mm	in
FJ9027-										
0808S	-08	3/4-16	89,4	3.52	51,3	2.02	9,9	0.39	47,5	1.87
1212S	-12	1 1/16-12	112,5	4.43	65,0	2.56	15,5	0.61	59,7	2.35
1616S	-16	1 5/16-12	135,6	5.34	83,3	3.28	20,8	0.82	77,2	3.04
FJ9028-										
2020S	-20	1 5/8-12	170,7	6.72	94,5	3.72	26,7	1.05	86,4	3.40
2424S	-24	1 7/8-12	191,0	7.52	115,8	4.56	32,5	1.28	100,3	3.95

Straight split flange
Code 61 SAE J518

190935-
FC7713-

Code 62 SAE J518

FC7370-
FC5973-

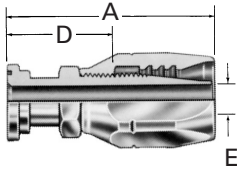

Dash size	Hose size	Flange head dia.		A		D		EØ	
		mm	in	mm	in	mm	in	mm	in
190935-									
8S	-08	30,2	1.19	102,9	4.05	64,5	2.54	9,4	0.37
12-8S	-08	38,1	1.50	102,9	4.05	64,5	2.54	9,4	0.37
12S	-12	38,1	1.50	121,7	4.79	74,2	2.92	14,2	0.56
16-12S	-12	44,5	1.75	121,7	4.79	74,2	2.92	14,2	0.56
16S	-16	44,5	1.75	144,5	5.69	92,2	3.63	20,6	0.81
20-16S	-16	50,8	2.00	144,5	5.69	92,2	3.63	20,6	0.81
FC7713-									
2020S	-20	50,8	2.00	174,2	6.86	98,0	3.86	26,7	1.05
2420S	-20	60,5	2.38	174,2	6.86	98,0	3.86	26,7	1.05
2424S	-24	60,5	2.38	199,6	7.86	124,5	4.90	32,5	1.28
3224S	-24	71,4	2.81	199,6	7.86	124,5	4.90	32,5	1.28
FC7370-									
1208S	-08	41,1	1.62	102,9	4.05	64,5	2.54	9,4	0.37
1212S	-12	41,1	1.62	121,7	4.79	74,2	2.92	14,2	0.56
1612S	-12	47,8	1.88	121,7	4.79	74,2	2.92	14,2	0.56
1616S	-16	47,8	1.88	144,5	5.69	92,2	3.63	20,6	0.81
2016S	-16	53,8	2.12	144,5	5.69	92,2	3.63	20,6	0.81
FC5973-									
2020S	-20	53,8	2.12	174,2	6.86	97,8	3.85	26,7	1.05
2420S	-20	63,5	2.50	174,2	6.86	97,8	3.85	26,7	1.05
2424S	-24	63,5	2.50	199,6	7.86	124,5	4.90	32,5	1.28
3224S	-24	79,2	3.12	199,6	7.86	124,5	4.90	32,5	1.28

Note: For flanges, split flange halves, kits and o-rings, see page I-61–I-68.
For socket part numbers, see page I-3.

Hose fittings – Reusable

For use with hose:
GH493, FC736

Spiral hose

Spiral skive style fittings

22 1/2° split flange

Code 61 SAE J518
FC9634-
FC7714-

Code 62 SAE J518
FC7983-
FC5974-

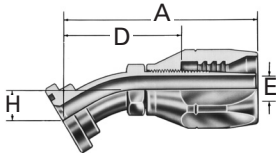

Dash size	Hose size	Flange head Dia.		A		D		EØ		H	
		mm	in	mm	in	mm	in	mm	in	mm	in
FC9634-											
0808S	-08	30,2	1.19	96,7	3.81	58,4	2.30	9,9	0.39	9,7	0.38
1208S	-08	38,1	1.50	96,7	3.81	58,4	2.30	9,9	0.39	9,7	0.38
1212S	-12	38,1	1.50	114,6	4.51	67,1	2.64	15,5	0.61	11,2	0.44
1612S	-12	44,5	1.75	114,6	4.51	67,1	2.64	15,5	0.61	11,2	0.44
1616S	-16	44,5	1.75	131,6	5.18	79,2	3.12	20,8	0.82	11,2	0.44
2016S	-16	50,8	2.00	131,6	5.18	79,2	3.12	20,8	0.82	11,2	0.44
FC7714-											
		mm	in	mm	in	mm	in	mm	in	mm	in
2020S	-20	50,8	2.00	167,9	6.61	91,7	3.61	26,7	1.05	12,7	0.50
2420S	-20	60,5	2.38	167,9	6.61	91,7	3.61	26,7	1.05	12,7	0.50
2424S	-24	60,5	2.38	192,0	7.56	117,1	4.61	32,5	1.28	16,0	0.63
3224S	-24	71,4	2.81	192,0	7.56	117,1	4.61	32,5	1.28	16,0	0.63
FC7983-											
		mm	in	mm	in	mm	in	mm	in	mm	in
1208S	-08	41,1	1.62	96,7	3.81	58,4	2.30	9,9	0.39	9,7	0.38
1212S	-12	41,1	1.62	114,6	4.51	67,1	2.64	15,5	0.61	11,2	0.44
1612S	-12	47,8	1.88	114,6	4.51	67,1	2.64	15,5	0.61	11,2	0.44
1616S	-16	47,8	1.88	131,6	5.18	79,2	3.12	20,8	0.82	11,2	0.44
2016S	-16	53,8	2.12	131,6	5.18	79,2	3.12	20,8	0.82	11,2	0.44
FC5974-											
		mm	in	mm	in	mm	in	mm	in	mm	in
2020S	-20	53,8	2.12	167,9	6.61	91,7	3.61	26,7	1.05	12,7	0.50
2420S	-20	63,5	2.50	167,9	6.61	91,7	3.61	26,7	1.05	12,7	0.50
2424S	-24	63,5	2.50	192,0	7.56	117,1	4.61	32,5	1.28	16,0	0.63
3224S	-24	79,2	3.12	192,0	7.56	117,1	4.61	57,9	2.28	16,0	0.63

30° split flange

Code 61 SAE J518
FC9459-
FC7790-

Code 62 SAE J518
FC7371-
FC5975-

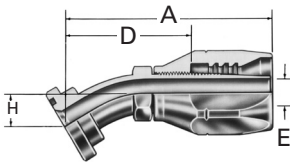

Dash size	Hose size	Flange head Dia.		A		D		EØ		H	
		mm	in	mm	in	mm	in	mm	in	mm	in
FC9459-											
0808S	-08	30,2	1.19	95,8	3.77	57,4	2.26	9,9	0.39	12,7	0.50
1208S	-08	38,1	1.50	95,8	3.77	57,4	2.26	9,9	0.39	12,7	0.50
1212S	-12	38,1	1.50	113,3	4.46	65,8	2.59	15,5	0.61	14,7	0.58
1612S	-12	44,5	1.75	113,3	4.46	65,8	2.59	15,5	0.61	14,7	0.58
1616S	-16	44,5	1.75	134,1	5.28	81,8	3.22	20,8	0.82	15,7	0.62
2016S	-16	50,8	2.00	134,1	5.28	81,8	3.22	20,8	0.82	15,7	0.62
FC7790-											
		mm	in	mm	in	mm	in	mm	in	mm	in
2020S	-20	50,8	2.00	172,2	6.78	96,0	3.78	26,7	1.05	18,3	0.72
2420S	-20	60,5	2.38	172,2	6.78	96,0	3.78	26,7	1.05	18,3	0.72
2424S	-24	60,5	2.38	195,1	7.68	120,1	4.73	32,5	1.28	22,4	0.88
3224S	-24	71,4	2.81	195,1	7.68	120,1	4.73	32,5	1.28	22,4	0.88
FC7371-											
		mm	in	mm	in	mm	in	mm	in	mm	in
1208S	-08	41,1	1.62	95,8	3.77	57,4	2.26	9,9	0.39	12,7	0.50
1212S	-12	41,1	1.62	113,3	4.46	65,8	2.59	15,5	0.61	14,7	0.58
1612S	-12	47,8	1.88	113,3	4.46	65,8	2.59	15,5	0.61	14,7	0.58
1616S	-16	47,8	1.88	134,1	5.28	81,8	3.22	20,8	0.82	15,7	0.62
2016S	-16	53,8	2.12	134,1	5.28	81,8	3.22	20,8	0.82	15,7	0.62
FC5975-											
		mm	in	mm	in	mm	in	mm	in	mm	in
2020S	-20	53,8	2.12	172,2	6.78	96,0	3.78	26,7	1.05	18,3	0.72
2420S	-20	63,5	2.50	172,2	6.78	96,0	3.78	26,7	1.05	18,3	0.72
2424S	-24	63,5	2.50	195,1	7.68	120,1	4.73	32,5	1.28	22,4	0.88
3224S	-24	79,2	3.12	195,1	7.68	120,1	4.73	32,5	1.28	22,4	0.88

Note: For correct socket part number, see page I-3.
For flanges, split flange halves, kits and o-rings, see page I-61–I-68.

Spiral skive style fittings

45° split flange

Code 61 SAE J518
190936-
FC7715-

Code 62 SAE J518
FC7372-
FC5976-

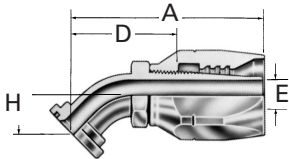

Dash size	Hose size	Flange head Dia.		A		D		EØ		H	
		mm	in	mm	in	mm	in	mm	in	mm	in
190936-											
8S	-08	30,2	1.19	96,0	3.78	57,7	2.27	9,4	0.37	19,8	0.78
12-8S	-08	38,1	1.50	96,0	3.78	57,7	2.27	9,4	0.37	19,8	0.78
12S	-12	38,1	1.50	119,6	4.71	72,1	2.84	14,2	0.56	25,4	1.00
16-12S	-12	44,5	1.75	119,6	4.71	72,1	2.84	14,2	0.56	25,4	1.00
16S	-16	44,5	1.75	140,5	5.53	88,1	3.47	20,6	0.81	26,9	1.06
20-16S	-16	50,8	2.00	140,5	5.53	88,1	3.47	20,6	0.81	26,9	1.06
FC7715-											
1620S	-20	44,5	1.75	169,2	6.66	93,0	3.66	20,8	0.82	26,9	1.06
2020S	-20	50,8	2.00	174,5	6.87	98,3	3.87	26,7	1.05	29,2	1.15
2420S	-20	60,5	2.38	174,5	6.87	98,3	3.87	26,7	1.05	29,2	1.15
2424S	-24	60,5	2.38	197,9	7.79	122,9	4.84	32,5	1.28	35,8	1.41
3224S	-24	71,4	2.81	197,9	7.79	122,9	4.84	32,5	1.28	35,8	1.41
FC7372-											
0808S	-08	31,8	1.25	96,0	3.78	57,7	2.27	9,4	0.37	19,8	0.78
1208S	-08	41,1	1.62	96,0	3.78	57,7	2.27	9,9	0.39	19,8	0.78
1212S	-12	41,1	1.62	119,6	4.71	72,1	2.84	15,5	0.61	25,4	1.00
1612S	-12	47,8	1.88	119,6	4.71	72,1	2.84	15,5	0.61	25,4	1.00
1616S	-16	47,8	1.88	140,5	5.53	88,1	3.47	20,8	0.82	26,9	1.06
2016S	-16	53,8	2.12	140,5	5.53	88,1	3.47	20,8	0.82	26,9	1.06
FC5976-											
2020S	-20	53,8	2.12	174,5	6.87	98,3	3.87	26,7	1.05	29,2	1.15
2420S	-20	63,5	2.50	174,5	6.87	98,3	3.87	26,7	1.05	29,2	1.15
2424S	-24	63,5	2.50	197,9	7.79	122,9	4.84	32,5	1.28	35,8	1.41
3224S	-24	79,2	3.12	197,9	7.79	122,9	4.84	32,5	1.28	35,8	1.41

60° split flange

Code 61 SAE J518
FC9066-
FC5060-

Code 62 SAE J518
FC7373-
FC5977-

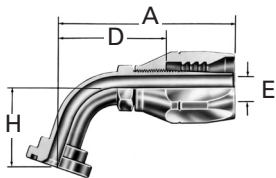

Dash size	Hose size	Flange head Dia.		A		D		EØ		H	
		mm	in	mm	in	mm	in	mm	in	mm	in
FC9066-											
0808S	-08	30,2	1.19	94,5	3.72	56,1	2.21	9,9	0.39	26,7	1.05
1208S	-08	38,1	1.50	94,5	3.72	56,1	2.21	9,9	0.39	26,7	1.05
1212S	-12	38,1	1.50	120,4	4.74	72,9	2.87	15,5	0.61	35,8	1.41
1612S	-12	44,5	1.75	120,4	4.74	72,9	2.87	15,5	0.61	35,8	1.41
1616S	-16	44,5	1.75	141,2	5.56	88,9	3.50	20,8	0.82	38,1	1.50
2016S	-16	50,8	2.00	141,2	5.56	88,9	3.50	20,8	0.82	38,1	1.50
FC5060-											
2020S	-20	50,8	2.00	177,0	6.97	100,8	3.97	26,7	1.05	42,2	1.66
2420S	-20	60,5	2.38	177,0	6.97	100,8	3.97	26,7	1.05	42,2	1.66
2024S	-24	50,8	2.00	184,7	7.27	109,7	4.32	26,7	1.05	42,2	1.66
2424S	-24	60,5	2.38	199,4	7.85	124,5	4.90	32,5	1.28	50,8	2.00
3224S	-24	71,4	2.81	199,4	7.85	124,5	4.90	32,5	1.28	50,8	2.00
FC7373-											
1208S	-08	41,1	1.62	94,5	3.72	56,1	2.21	9,9	0.39	26,7	1.05
1212S	-12	41,1	1.62	120,4	4.74	72,9	2.87	15,5	0.61	35,8	1.41
1612S	-12	47,8	1.88	120,4	4.74	72,9	2.87	15,5	0.61	35,8	1.41
1616S	-16	47,8	1.88	141,2	5.56	88,9	3.50	20,8	0.82	38,1	1.50
2016S	-16	53,8	2.12	141,2	5.56	88,9	3.50	20,8	0.82	38,1	1.50
FC5977-											
2020S	-20	53,8	2.12	177,0	6.97	100,8	3.97	26,7	1.05	42,2	1.66
2420S	-20	63,5	2.50	177,0	6.97	100,8	3.97	26,7	1.05	42,2	1.66
2424S	-24	63,5	2.50	199,4	7.85	124,5	4.90	32,5	1.28	50,8	2.00
3224S	-24	79,2	3.12	199,4	7.85	124,5	4.90	32,5	1.28	50,8	2.00

Note: For correct socket part number, see page I-3.

For flanges, split flange halves, kits and o-rings, see page I-61–I-68.

Hose fittings – Reusable

For use with hose:
GH493, FC736

Spiral hose

Spiral skive style fittings

67 1/2° split flange

Code 61 SAE J518
FC9118-
FC7811-

Code 62 SAE J518
FC7984-
FJ9034-

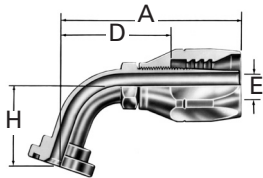

Dash size	Hose size	Flange head Dia.		A		D		EØ		H	
		mm	in	mm	in	mm	in	mm	in	mm	in
FC9118-											
0808S	-08	30,2	1.19	95,8	3.77	57,4	2.26	9,9	0.39	31,8	1.25
1208S	-08	38,1	1.50	95,8	3.77	57,4	2.26	9,9	0.39	31,8	1.25
1212S	-12	38,1	1.50	119,1	4.69	71,6	2.82	15,5	0.61	40,6	1.60
1612S	-12	44,5	1.75	119,1	4.69	71,6	2.82	15,5	0.61	40,6	1.60
1616S	-16	44,5	1.75	141,7	5.58	89,7	3.53	20,8	0.82	44,5	1.75
2016S	-16	50,8	2.00	141,7	5.58	89,7	3.53	20,8	0.82	44,5	1.75
FC7811-											
2020S	-20	50,8	2.00	176,3	6.94	100,1	3.94	26,7	1.05	48,3	1.90
2420S	-20	60,5	2.38	176,3	6.94	100,1	3.94	26,7	1.05	48,3	1.90
2424S	-24	60,5	2.38	187,5	7.38	112,5	4.43	32,5	1.28	50,8	2.00
3224S	-24	71,4	2.81	187,5	7.38	112,5	4.43	32,5	1.28	50,8	2.00
FC7984-											
1208S	-08	41,1	1.62	95,8	3.77	57,4	2.26	9,9	0.39	31,8	1.25
1212S	-12	41,1	1.62	119,1	4.69	71,6	2.82	5,5	0.61	40,6	1.60
1612S	-12	47,8	1.88	119,1	4.69	71,6	2.82	15,5	0.61	40,6	1.60
1616S	-16	47,8	1.88	141,7	5.58	89,7	3.53	20,8	0.82	44,5	1.75
2016S	-16	53,8	2.12	141,7	5.58	89,7	3.53	20,8	0.82	44,5	1.75
FC9034-											
2020S	-20	53,8	2.12	176,3	6.94	100,1	3.94	26,7	1.05	48,3	1.90
2420S	-20	63,5	2.50	176,3	6.94	100,1	3.94	26,7	1.05	48,3	1.90
2424S	-24	63,5	2.50	187,5	7.38	112,5	4.43	32,5	1.28	50,8	2.00
3224S	-24	79,2	3.12	187,5	7.38	112,5	4.43	32,5	1.28	50,8	2.00

90° split flange

Code 61 SAE J518
190937-
FC7703-

Code 62 SAE J518
FC7374-
FJ9033-

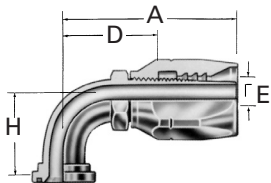

Dash size	Hose size	Flange head Dia.		A		D		EØ		H	
		mm	in	mm	in	mm	in	mm	in	mm	in
190937-											
8S	-08	30,2	1.19	89,4	3.52	51,3	2.02	9,9	0.39	41,1	1.62
12-8S	-08	38,1	1.50	89,4	3.52	51,3	2.02	9,9	0.39	41,1	1.62
12S	-12	38,1	1.50	112,5	4.43	65,0	2.56	15,5	0.61	54,1	2.13
16-12S	-12	44,5	1.75	112,5	4.43	65,0	2.56	15,5	0.61	54,1	2.13
20-12S	-12	50,8	2.00	112,5	4.43	65,0	2.56	15,5	0.61	54,1	2.13
16S	-16	44,5	1.75	135,6	5.34	83,3	3.28	20,8	0.82	60,5	2.38
20-16S	-16	50,8	2.00	135,6	5.34	83,3	3.28	20,8	0.82	60,5	2.38
24-16S	-16	60,5	2.38	135,6	5.34	83,3	3.28	20,8	0.82	60,5	2.38
FC7703-											
2020S	-20	50,8	2.00	170,7	6.72	94,5	3.72	26,7	1.05	66,5	2.62
2420S	-20	60,5	2.38	170,7	6.72	94,5	3.72	26,7	1.05	66,5	2.62
2424S	-24	60,5	2.38	191,0	7.52	115,8	4.56	32,5	1.28	79,2	3.12
3224S	-24	71,4	2.81	191,0	7.52	115,8	4.56	32,5	1.28	79,2	3.12
FC7374-											
0808S	-08	31,8	1.25	89,4	3.52	51,3	2.02	9,9	0.39	41,1	1.62
1208S	-08	41,1	1.62	89,4	3.52	51,3	2.02	9,9	0.39	41,1	1.62
1212S	-12	41,1	1.62	112,5	4.43	65,0	2.56	15,5	0.61	54,1	2.13
1612S	-12	47,8	1.88	112,5	4.43	65,0	2.56	15,5	0.61	54,1	2.13
1616S	-16	47,8	1.88	135,6	5.34	83,3	3.28	20,8	0.82	60,5	2.38
2016S	-16	53,8	2.12	135,6	5.34	83,3	3.28	20,8	0.82	57,9	2.28
FJ9033-											
2020S	-20	53,8	2.12	170,7	6.72	94,5	3.72	26,7	1.05	66,5	2.62
2420S	-20	63,5	2.50	170,7	6.72	94,5	3.72	26,7	1.05	66,5	2.62
2424S	-24	63,5	2.50	191,0	7.52	115,8	4.56	32,5	1.28	79,2	3.12
3224S	-24	79,2	3.12	191,0	7.52	115,8	4.56	32,5	1.28	79,2	3.12

Note: For correct socket part number, see page I-3.

Note: For flanges, split flange halves, kits and o-rings, see page I-61-I-68.

Spiral skive style

ORS swivel straight

FJ9740-
FJ9744-

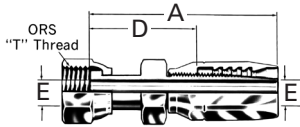

Dash size	Hose size	Thread	A		D		EØ	
			mm	in	mm	in	mm	in
FJ9740-								
0606S	-06	11/16-16	85,1	3.35	43,7	1.72	6,6	0.26
0808S	-08	13/16-16	86,4	3.40	48,0	1.89	9,9	0.39
1212S	-12	1 3/16-12	102,9	4.05	55,4	2.18	15,5	0.61
1616S	-16	1 7/16-12	121,4	4.78	67,6	2.66	20,8	0.82
FJ9744-								
2020S	-20	1 11/16-12	148,6	5.85	72,4	2.85	26,7	1.05
2424S	-24	2-12	156,0	6.14	81,3	3.20	32,0	1.26

ORS swivel 45° elbow

FJ9741-
FJ9745-

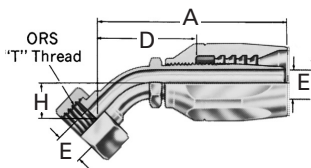

Dash size	Hose size	Thread	A		D		EØ		H	
			mm	in	mm	in	mm	in	mm	in
FJ9741-										
0808S	-08	13/16-16	89,9	3.54	51,3	2.02	9,4	0.37	15,0	0.59
1212S	-12	1 3/16-12	115,1	4.53	67,6	2.66	14,2	0.56	21,1	0.83
1616S	-16	1 7/16-12	140,5	5.53	88,1	3.47	20,6	0.81	23,9	0.94
FJ9745-										
2020S	-20	1 11/16-12	167,1	6.58	90,9	3.58	25,7	1.01	25,4	1.00

ORS swivel 90° elbow short drop

FJ9742-
FJ9746-

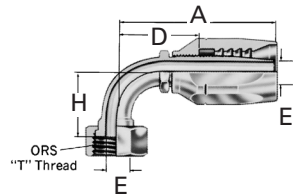

Dash size	Hose size	Thread	A		D		EØ		H	
			mm	in	mm	in	mm	in	mm	in
FJ9742-										
0808S	-08	13/16-16	83,8	3.30	45,5	1.79	9,4	0.37	29,2	1.15
1212S	-12	1 3/16-12	112,5	4.43	65,0	2.56	14,2	0.56	47,8	1.88
1616S	-16	1 7/16-12	133,1	5.24	80,8	3.18	20,6	0.81	56,1	2.21
FJ9746-										
2020S	-20	1 11/16-12	169,2	6.66	93,0	3.66	25,7	1.01	63,8	2.51
2424S	-24	2-12	191,0	7.52	115,8	4.56	30,2	1.19	68,6	2.70

ORS swivel 90° elbow long drop

FJ9743-
FJ9747-

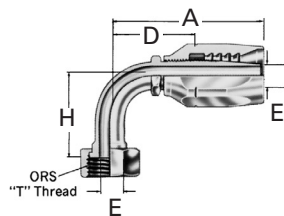

Dash size	Hose size	Thread	A		D		EØ		H	
			mm	in	mm	in	mm	in	mm	in
FJ9743-										
0808S	-08	13/16-16	89,4	3.52	51,3	2.02	9,4	0.37	63,8	2.51
1212S	-12	1 3/16-12	112,5	4.43	65,0	2.56	14,2	0.56	96,0	3.78
1616S	-16	1 7/16-12	135,6	5.34	83,3	3.28	20,6	0.81	114,3	4.50
FJ9747-										
2020S	-20	1 11/16-12	170,7	6.72	94,5	3.72	25,7	1.01	129,3	5.09
2424S	-24	2-12	191,0	7.52	115,8	4.56	32,8	1.29	140,7	5.54

Komatsu 30° swivel-metric threads

FJ7286-

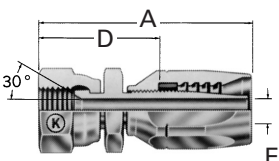

Dash size	Hose size	Thread	A		D		EØ	
			mm	in	mm	in	mm	in
FJ7286-								
0408S	-08	M22 x 1.5	84,3	3.32	42,2	1.66	9,4	0.37
0512S	-12	M24 x 1.5	99,6	3.92	52,3	2.06	12,2	0.48
0612S	-12	M30 x 1.5	103,6	4.08	56,4	2.22	15,5	0.61
1016S	-16	M33 x 1.5	123,4	4.86	70,1	2.76	20,3	0.80

Note: For correct socket part number, see page I-3.

Hose fittings – Reusable

For use with hose:
2556, 2565, 2575, FC332,
FC647, H201

SOCKETLESS hose

SOCKETLESS fittings

Male pipe

4738-

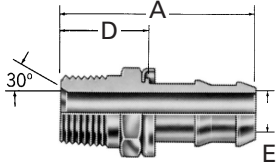

Dash size	Hose size	Thread	A		D		EØ	
			mm	in	mm	in	mm	in
4738-								
2-4B	-04	1/8-27	36,8	1.45	17,8	0.70	4,3	0.17
4-4B	-04	1/4-18	41,4	1.63	22,4	0.88	4,3	0.17
4-6B	-06	1/4-18	45,7	1.80	23,9	0.94	7,6	0.30
6-4B	-04	3/8-18	42,9	1.69	23,9	0.94	4,3	0.17
6-6B	-06	3/8-18	45,7	1.80	23,9	0.94	7,6	0.30
6-8B	-08	3/8-18	49,5	1.95	23,9	0.94	9,9	0.39
8-8B	-08	1/2-14	56,9	2.20	30,2	1.19	9,9	0.39
8-10B	-10	1/2-14	69,3	2.73	30,2	1.19	12,2	0.48
12-12B	-12	3/4-14	70,4	2.77	36,8	1.45	15,5	0.61
16-16B	-16	1-11 1/2	78,2	3.08	36,8	1.45	21,6	0.85

Male pipe swivel

FJ9068-

FJ9486-

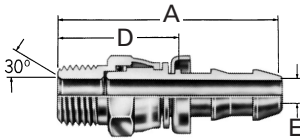

Dash size	Hose size	Thread	A		D		EØ	
			mm	in	mm	in	mm	in
FJ9068-								
0404S	-04	1/4-18	55,6	2.19	36,3	1.43	4,3	0.17
0606S	-06	3/8-18	58,4	2.30	36,3	1.43	7,6	0.30
0808S	-08	1/2-14	68,6	2.69	42,9	1.68	9,9	0.39
FJ9486-								
0204B	-04	1/8-27	43,9	1.73	24,6	0.97	3,0	0.12

**Uses Neoprene o-ring

Female pipe

4753-

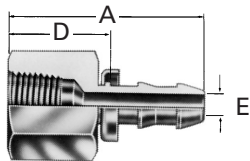

Dash size	Hose size	Thread	A		D		EØ	
			mm	in	mm	in	mm	in
4753-								
4-4B	-04	1/4-18	39,4	1.55	20,3	0.80	4,3	0.17
6-6B	-06	3/8-18	43,7	1.72	21,8	0.86	7,6	0.30
8-8B	-08	1/2-14	52,3	2.06	26,7	1.05	9,9	0.39

Female NPSM swivel

FC5853-

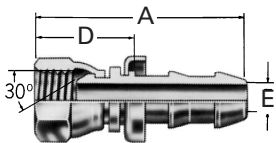

Dash size	Hose size	Thread	A		D		EØ	
			mm	in	mm	in	mm	in
FC5853-								
0404S	-04	1/4-18	41,7	1.64	22,6	0.89	4,3	0.17
0606S	-06	3/8-18	44,5	1.75	22,6	0.89	7,6	0.30
0808S	-08	1/2-14	51,6	2.03	25,7	1.01	9,9	0.39
1212S	-12	3/4-14	66,8	2.63	28,2	1.11	15,5	0.61

SOCKETLESS fittings

Male pipe

Universal†

4797-

SAE 45°*

4739-

SAE 37° (JIC)

4741-

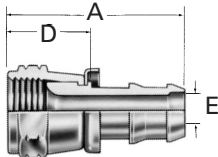

Dash size	Hose size	Thread	A		D		EØ	
			mm	in	mm	in	mm	in
4797-								
4B†	-04	7/16-20	39,4	1.55	20,3	0.80	4,3	0.17
5-4B†	-04	1/2-20	40,6	1.60	21,3	0.84	4,3	0.17
8-6B†	-06	3/4-16	48,0	1.89	25,9	1.02	7,6	0.30
8B†	-08	3/4-16	51,6	2.03	25,9	1.02	9,9	0.39
10-8B†	-08	7/8-14	55,4	2.18	29,5	1.16	9,9	0.39
10B†	-10	7/8-14	68,1	2.68	29,0	1.14	12,2	0.48
4739-								
6B*	-06	5/8-18	44,4	1.75	22,6	0.89	7,6	0.30
12B*	-12	1 1/16-14	70,1	2.76	31,5	1.24	15,5	0.61
4741-								
6B	-06	9/16-18	44,4	1.75	22,6	0.866	7,6	0.30
12B	-12	1 1/16-12	74,8	2.94	36,1	1.42	15,5	0.61

†Double notch in nut for Universal type identification for both SAE 45° and 37° (JIC) connections.

*Single notch in nut for SAE 45° identification.

SAE 37° (JIC) male flare

190672-

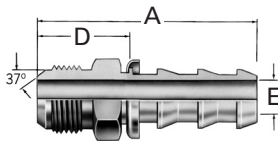

Dash size	Hose size	Thread	A		D		EØ	
			mm	in	mm	in	mm	in
190672-								
4B	-04	7/16-20	42,2	1.66	23,1	0.91	4,3	0.17
6B	-06	9/16-18	52,2	1.75	23,6	0.92	7,6	0.30
6S	-06	9/16-18	44,5	1.75	22,6	0.89	7,6	0.39

SAE 45° (JIC) male flare

4742-

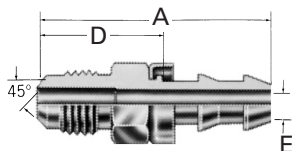

Dash size	Hose size	Thread	A		D		EØ	
			mm	in	mm	in	mm	in
4742-								
4B	-04	7/16-20	40,9	1.61	21,8	0.86	4,3	0.17
5-4B	-04	1/2-20	42,4	1.67	23,4	0.92	4,3	0.17
6B	-06	5/8-18	46,7	1.84	24,9	0.98	7,1	0.28
8B	-08	3/4-16	53,8	2.12	28,2	1.11	9,9	0.39

SAE 45° inverted male flare

4740-

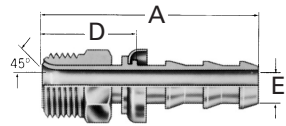

Dash size	Hose size	Thread	A		D		EØ	
			mm	in	mm	in	mm	in
4740-								
3-4B	-04	3/8-24	38,9	1.52	19,8	0.78	3,3	0.13
4B	-04	7/16-24	39,4	1.55	20,3	0.80	4,3	0.17
5-4B	-04	1/2-20	40,9	1.61	21,6	0.85	4,3	0.17
6B	-06	5/8-18	44,4	1.75	22,6	0.89	7,6	0.30
8B	-08	3/4-18	50,5	1.99	24,6	0.97	9,9	0.39
10B	-10	7/8-18	65,5	2.58	26,4	1.04	12,2	0.48

Hose fittings – Reusable

For use with hose:
2556, 2565, FC332,
FC647, H201

SOCKETLESS hose

SOCKETLESS fittings

SAE 42° inverted female flare

4743-

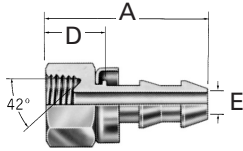

Dash size	Hose size	Thread	A		D		EØ	
			mm	in	mm	in	mm	in
4743-								
3-4B	-04	3/8-24	31,5	1.24	12,4	0.49	3,3	0.13
4B	-04	7/16-24	31,5	1.24	12,4	0.49	4,3	0.17
5-4B	-04	1/2-20	32,3	1.27	13,2	0.52	4,3	0.17
6B	-06	5/8-18	36,6	1.44	14,7	0.58	7,6	0.30
8-6B	-06	3/4-18	37,5	1.48	15,5	0.61	7,6	0.30

Hose mender

4772-

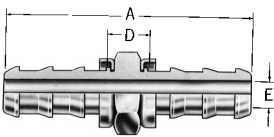

Dash size	Hose size	A		D		EØ	
		mm	in	mm	in	mm	in
4772-							
4B	-04	48,5	1.91	10,4	0.41	4,3	0.17
6B	-06	54,4	2.14	10,4	0.41	7,6	0.30
8B	-08	63,5	2.5	11,9	0.47	9,9	0.39
10B	-10	91,7	3.61	13,5	0.53	12,2	0.48
12B	-12	92,2	3.63	15,2	0.60	15,5	0.61

Compression type

4750-

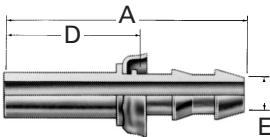

Dash size	Hose size	Tube size	A		D		EØ	
			mm	in	mm	in	mm	in
4750-								
3-4B	-04	-03	45,7	1.80	26,7	1.05	3,3	0.13
4B	-04	-04	47,3	1.86	28,2	1.11	4,3	0.17
5-4B	-04	-05	53,3	2.1	31,5	1.24	4,3	0.17
6B	-06	-06	60,2	2.37	34,5	1.36	7,6	0.30
8B	-08	-08	66,0	2.6	26,9	1.06	9,9	0.39
10B	-10	-10	65,3	2.57	26,2	1.03	12,2	0.48

45° elbow SAE 45° swivel*

FC5848-

SAE 37° (JIC) swivel

FC5847-

Universal swivel†

FC5849-

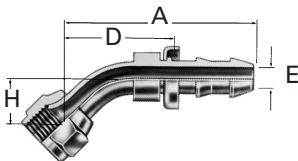

Dash size	Hose size	Tube size	A		D		EØ		H	
			mm	in	mm	in	mm	in	mm	in
FC5848-										
0606S*	-06	5/8-18	45,7	1.80	23,6	0.93	7,6	0.30	9,9	0.39
FC5847-										
0606S	-06	9/16-18	45,7	1.80	23,6	0.93	7,6	0.30	9,9	0.39
FC5849-										
0404S†	-04	7/16-20	39,6	1.56	20,6	0.81	4,3	0.17	8,4	0.33
0808S†	-08	3/4-16	58,4	2.30	32,5	1.28	9,9	0.39	14,0	0.55

†Double notch in nut for Universal type identification for both SAE 45° and 37° (JIC) connections.

*Single notch in nut for SAE 45° identification.

For use with hose:
2556, 2565, FC332,
FC647, H201

Hose fittings – Reusable

SOCKETLESS hose

SOCKETLESS fittings

90° elbow (short)

SAE 45° swivel*

190328-

SAE 37° (JIC) swivel*

190516-

90° elbow (long)

SAE 37° (JIC) swivel

190465-

Universal swivel†

FC5852-

Dash size	Hose size	Thread	A		D		EØ		H	
			mm	in	mm	in	mm	in	mm	in
190328-										
6S*	-06	5/8-18	42,9	1.69	21,1	0.83	7,6	0.30	21,6	0.85
190516-										
6S	-06	9/16-18	43,8	1.70	21,1	0.83	7,6	0.30	21,6	0.85
190465-										
6S	-06	9/16-18	43,8	1.70	21,1	0.83	7,6	0.30	55,4	2.18
FC5852-										
0404S†	-04	7/16-20	36,8	1.45	17,8	0.70	4,3	0.17	45,7	1.80

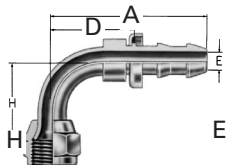

SAE male inverted
flare 45° elbow

190944-

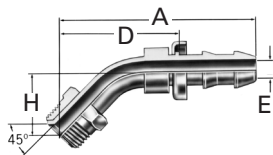

Dash size	Hose size	Thread	A		D		EØ		H	
			mm	in	mm	in	mm	in	mm	in
190944-										
4S	-04	7/16-24	62,5	2.46	43,8	1.70	4,3	0.17	24,4	0.96
6S	-06	5/8-18	65,3	2.57	43,8	1.71	7,6	0.30	24,4	0.96

SAE male inverted
flare 90° elbow (short)

190327-

SAE male inverted
flare 90° elbow (long)

190326-

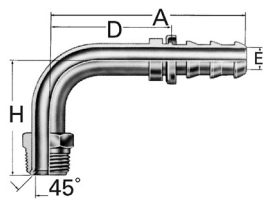

Dash size	Hose size	Thread	A		D		EØ		H	
			mm	in	mm	in	mm	in	mm	in
190327-										
4S	-04	7/16-24	52,8	2.08	33,8	1.33	4,3	0.17	42,9	1.69
6S	-06	5/8-18	55,9	2.20	33,8	1.33	7,6	0.30	43,9	1.73
190326-										
6S	-06	5/8-18	82,3	3.24	60,5	2.38	7,6	0.30	69,3	2.73

ORS swivel straight

FJ7044-

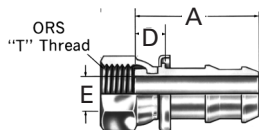

Dash size	Hose size	Thread	A		D		EØ	
			mm	in	mm	in	mm	in
FJ7044-								
0404S	-04	9/16-18	27,9	1.10	9,0	0.35	4,3	0.17
0606S	-06	11/16-16	32,0	1.26	9,7	0.38	6,6	0.26
0806S	-06	13/16-16	34,5	1.36	12,4	0.49	7,6	0.30
0808S	-08	13/16-16	38,1	1.50	12,4	0.49	9,7	0.38
1010S	-10	1-14	51,6	2.03	12,4	0.49	12,2	0.48
1212S	-12	1 3/16-12	52,6	2.07	14,0	0.55	15,5	0.61

†Double notch in nut for Universal type identification for both SAE 45° and 37° (JIC) connections.

*Single notch in nut for SAE 45° identification.

Hose fittings – Reusable

For use with hose:
2556, 2565, FC332,
FC647, H201

SOCKETLESS hose

SOCKETLESS fittings

**Metric male 24°
DIN 3901/3902 I. Rh.**

07.021-

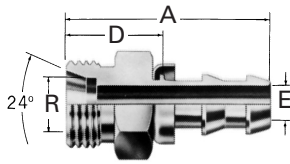

Dash size	Hose size	Thread	A		D		EØ		H	
			mm	in	mm	in	mm	in	mm	in
07.021-										
6-4	-04	M12 x 1.5	38,0	1.50	19,0	0.75	4,0	0.16	6,0	0.24
10-6	-06	M16 x 1.5	42,0	1.65	20,0	0.79	7,5	0.30	10,0	0.39

**Metric universal
female swivel 24°
DIN 3901/3902 I.Rh.**

07.006-

07.001-

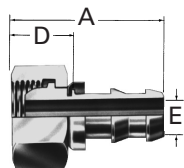

Dash size	Hose size	Thread	A		D		EØ		RØ	
			mm	in	mm	in	mm	in	mm	in
07.006-										
4-4†	-04	M12 x 1.5	35,5	1.40	16,4	0.64	4,0	0.16	6,0	0.24
8-6†	-06	M16 x 1.5	43,0	1.69	19,5	0.77	7,5	0.30	10,0	0.39
07.001-										
6-4†	-04	M14 x 1.5	35,0	1.38	16,0	0.63	4,0	0.16	8,0	0.31
10-6†	-06	M18 x 1.5	38,5	1.52	16,5	0.65	7,5	0.30	12,0	0.47
13-8†	-08	M22 x 1.5	42,5	1.67	16,7	0.66	10,0	0.39	15,0	0.59
16-10†	-10	M26 x 1.5	57,0	2.24	18,0	0.71	12,0	0.47	18,0	0.71

Material for BSP and metric fittings is steel.

*RØ is tube O.D. and refers to mating component when not called out on the illustration.

†Universal fitting also mates with DIN 7631/7647 60° connections.

For use with hose:
2556, 2565, FC332,
FC647, H201, 35FH

Hose fittings – Reusable

SOCKETLESS hose

SOCKETLESS fittings

ORS swivel 45° elbow

FJ7023-

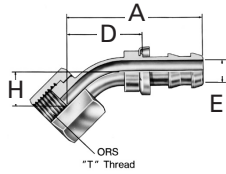

Dash size	Hose size	Thread	A		D		EØ		H	
			mm	in	mm	in	mm	in	mm	in
FJ7023-										
0404S	-04	9/16-18	41,7	1.64	22,6	0.89	4,3	0.17	10,4	0.41
0606S	-06	11/16-16	46,7	1.84	24,6	0.97	7,6	0.30	11,2	0.44
0808S	-08	13/16-16	59,4	2.34	33,5	1.32	9,9	0.39	15,0	0.59
1212S	-12	1 3/16-12	86,9	3.42	48,3	1.90	15,5	0.61	21,1	0.83

ORS swivel 90° elbow

FJ7358-

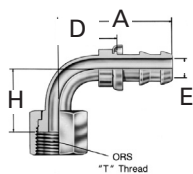

Dash size	Hose size	Thread	A		D		EØ		H	
			mm	in	mm	in	mm	in	mm	in
FJ7358-										
0404S	-04	9/16-18	38,6	1.52	19,6	0.77	4,3	0.17	20,8	0.82
0606S	-06	11/16-16	43,8	1.70	23,6	0.93	7,6	0.30	23,1	0.91
0804S	-04	13/16-16	45,7	1.80	26,7	1.05	4,3	0.17	29,2	1.15
0806S	-06	13/16-16	48,5	1.91	26,7	1.05	7,6	0.30	29,2	1.15
0808S	-08	13/16-16	52,3	2.06	26,7	1.05	9,9	0.39	29,2	1.15
1212S	-12	1 3/16-12	84,3	3.32	43,8	1.70	15,5	0.61	48,3	1.90

BSP SOCKETLESS male

07.122-

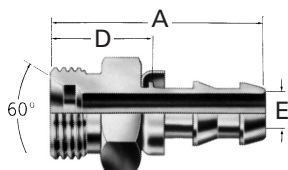

Dash size	Hose size	Thread	A		D		EØ	
			mm	in	mm	in	mm	in
07.122-								
4-4	-04	1/4-19	39,5	1.56	18,0	0.71	4,0	0.16
6-6	-06	3/8-19	44,0	1.73	20,0	0.79	7,5	0.30
8-8	-08	1/2-14	50,0	1.97	22,0	0.87	10,0	0.39

BSP SOCKETLESS, metric female swivel

07.390-

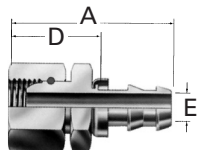

Dash size	Hose size	Thread	A		D		EØ	
			mm	in	mm	in	mm	in
07.390-								
4-4	-04	1/4-19	35,0	1.38	16,0	0.63	4,0	0.16
6-6	-06	3/8-19	39,0	1.54	17,0	0.67	7,5	0.30
8-8	-08	1/2-14	44,0	1.73	18,0	0.71	10,0	0.39

Material for BSP and metric fittings is steel.

Hose fittings – Reusable

For use with hose:
2550, 2554, 2570

Speciality hose

Power steering & air brake

Male pipe

479301-

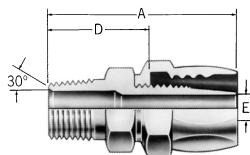

Dash size	Hose size	Thread	A		D		EØ	
			mm	in	mm	in	mm	in
479301-								
4-4S	-04	1/4-18	51,6	2.03	27,7	1.09	4,8	0.19
4-6S	-06	1/4-18	54,4	2.14	29,0	1.14	7,6	0.30
6-6S	-06	3/8-18	54,4	2.14	29,0	1.14	7,6	0.30
6-8S	-08	3/8-18	66,0	2.60	34,5	1.36	10,4	0.41
8-6S	-06	1/2-14	58,9	2.32	33,5	1.32	7,6	0.30
8-8S	-08	1/2-14	72,4	2.85	40,1	1.58	9,1	0.36

SAE 37° (JIC) swivel

190800-

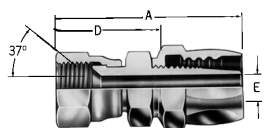

Dash size	Hose size	Thread	A		D		EØ	
			mm	in	mm	in	mm	in
190800-								
4S	-04	7/16-20	52,8	2.08	29,0	1.14	4,3	0.17
5-4S	-04	1/2-20	54,1	2.13	30,2	1.19	4,8	0.19
6S	-06	9/16-18	58,6	2.31	33,3	1.31	7,6	0.30
8S	-08	3/4-16	58,6	2.31	41,4	1.63	10,4	0.41

SAE 37° (JIC) male flare

FC7275-

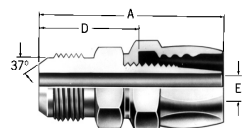

Dash size	Hose size	Thread	A		D		EØ	
			mm	in	mm	in	mm	in
FC7275-								
0606S	-06	9/16-18	58,9	2.32	33,5	1.32	7,6	0.30

USF swivel

479501-

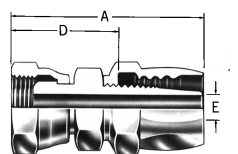

Dash size	Hose size	Thread	A		D		EØ	
			mm	in	mm	in	mm	in
479501-								
8-6S	-06	3/4-20	58,2	2.29	26,9	1.06	7,6	0.30
8-8S	-08	3/4-20	71,4	2.81	33,81	1.33	10,4	0.41

Male inverted flare

190604-

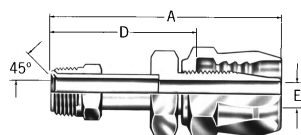

Dash size	Hose size	Thread	A		D		EØ	
			mm	in	mm	in	mm	in
190604-								
4-6S	-06	7/16-24	67,8	2.67	42,4	1.67	4,6	0.18
6S	-06	5/8-18	67,8	2.67	42,4	1.67	7,6	0.30

Note: For correct socket part number, see page I-3.

Power steering & air brake

Male inverted flare
45° elbow

190606-

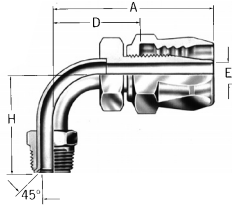

Dash size	Hose size	Thread	A		D		EØ		H	
			mm	in	mm	in	mm	in	mm	in
190606-										
6S	-06	5/8-18	65,5	2.58	40,1	1.58	7,6	0.30	43,9	1.73

SAE 45° swivel

479601-

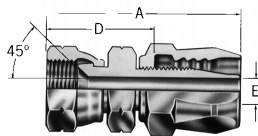

Dash size	Hose size	Thread	A		D		EØ	
			mm	in	mm	in	mm	in
479601-								
4-6S	-06	7/16-20	53,8	2.12	28,7	1.13	4,3	0.17
6S	-06	5/8-18	58,6	2.31	33,3	1.31	7,6	0.30

SAE 45° swivel
45° elbow

190607-

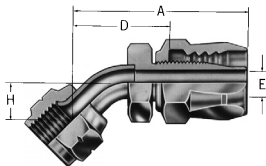

Dash size	Hose size	Thread	A		D		EØ		H	
			mm	in	mm	in	mm	in	mm	in
190607-										
4-6S	-06	7/16-20	52,3	2.06	26,9	1.06	4,6	0.18	8,4	0.33

SAE 45° swivel
90° elbow

190608-

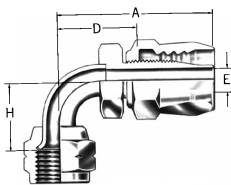

Dash size	Hose size	Thread	A		D		EØ		H	
			mm	in	mm	in	mm	in	mm	in
190608-										
4-6S	-06	7/16-20	49,5	1.95	24,1	0.95	4,6	0.18	17,3	0.68

SAE male flareless
with nut and ferrule

190609-

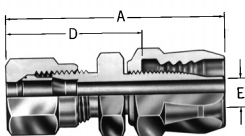

Dash size	Hose size	Thread	A		D		EØ	
			mm	in	mm	in	mm	in
190609-								
4-6S	-06	7/16-20	62,0	2.44	24,6	0.97	5,1	0.20

Note: For correct socket part number, see page I-3.

Hose fittings – Reusable

For use with hose:
1531, 1531A

Speciality hose

Railroad air brake

Straight split flange

FJ4649-

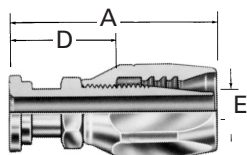

Nipple Part #	Socket Part #	Hose Size	A		D		EØ	
			mm	in	mm	in	mm	in
FJ4649-								
1216S	1219-16S	-16	84,2	2.89	43,4	1.31	20,6	0.76
1620S	1219-20S	-20	84,2	3.31	39,7	1.56	26,7	1.05
2024S	1219-24S	-24	84,2	3.13	43,9	1.32	32,5	1.26

45° elbow 2 bolt split flange

FJ4709-

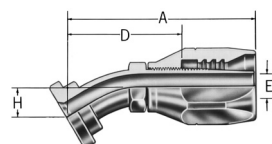

Nipple Part #	Socket Part #	Hose Size	A		D		EØ		H	
			mm	in	mm	in	mm	in	mm	in
FJ4709-										
1620S	1219-20S	-20	102,4	4.03	64,5	2.54	26,7	1.05	23,1	0.91
2024S	1219-24S	-24	120,1	4.73	79,2	3.12	32,5	1.28	26,2	1.03

90° elbow 2 bolt split flange

FJ4650-

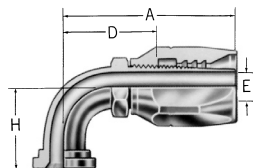

Nipple Part #	Socket Part #	Hose Size	A		D		EØ		H	
			mm	in	mm	in	mm	in	mm	in
FJ4650-										
1216S	1219-16S	-16	92,7	3.65	57,9	2.28	20,6	0.81	52,3	2.06
1620S	1219-20S	-20	105,4	4.15	67,6	2.66	26,7	1.05	58,6	2.31
2024S	1219-24S	-24	116,8	4.60	116,8	4.60	32,5	1.28	66,8	2.63

Male pipe

458-

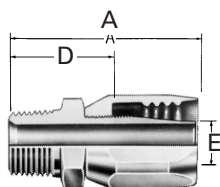

Dash size	Hose size	Thread	A		D		EØ	
			mm	in	mm	in	mm	in
458-								
8-10S	-10	1/2-14	72,4	2.85	42,4	1.67	11,4	0.45
12-12S	-12	3/4-14	74,2	2.92	42,4	1.67	14,7	0.58
12-16S	-16	3/4-14	80,2	3.16	45,5	1.79	20,6	0.81
16-16S	-16	1-11 1/2	85,1	3.35	50,8	1.98	20,6	0.81
16-20S	-20	1-11 1/2	91,7	3.61	53,6	2.11	26,7	1.05
20-24S	-24	1 1/4-11 1/2	95,5	3.76	54,6	2.15	32,5	1.28

*Contact Eaton for flange part number
need flange data

“Super gem”

Male pipe
38-190627-

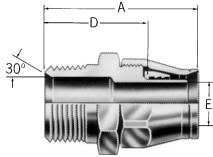

Dash size	Hose size	Thread	A		D		EØ	
			mm	in	mm	in	mm	in
38-190627-								
2-4*	-04	1/8-27	34,3	1.35	22,6	0.89	4,1	0.16
4-4*	-04	1/4-18	39,1	1.54	27,4	1.08	4,1	0.16
4-5*	-05	1/4-18	40,1	1.58	27,2	1.07	5,8	0.23
4-6*	-06	1/4-18	42,2	1.66	28,7	1.13	7,1	0.28
6-6*	-06	3/8-18	42,2	1.66	28,7	1.13	7,1	0.28
6-8*	-08	3/8-18	45,5	1.79	29,5	1.16	9,7	0.38
8-10*	-10	1 1/2-14	54,1	2.13	37,1	1.46	11,9	0.47
12-12*	-12	3/4-14	57,4	2.26	40,9	1.61	15,0	0.59
16-16*	-16	1-11 1/2	63,0	2.48	47,2	1.86	21,1	0.83
20-20*	-20	1 1/4-11 1/2	71,9	2.83	55,1	2.17	26,9	1.06

SAE 37° (JIC) Swivel
63-190600-

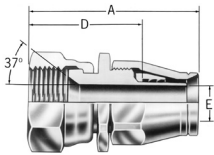

Dash size	Hose size	Thread	A		D		EØ	
			mm	in	mm	in	mm	in
63-190600-								
3*	-03	3/8-24	35,0	1.38	26,4	1.04	2,2	0.09
4*	-04	7/16-20	40,1	1.58	28,7	1.13	4,1	0.16
5*	-05	1/2-20	42,7	1.68	29,7	1.17	5,8	0.23
6*	-06	9/16-18	44,2	1.74	31,0	1.22	6,6	0.26
8*	-08	3/4-16	50,8	1.98	34,3	1.35	9,7	0.38
10*	-10	7/8-14	56,4	2.22	39,1	1.54	11,9	0.47
12*	-12	1 1/16-12	59,2	2.33	42,4	1.67	15,0	0.59
16*	-16	1 5/16-12	64,0	2.52	48,5	1.91	21,1	0.83
20*	-20	1 5/8-12	74,2	2.92	57,7	2.27	26,9	1.06

*Also supplied in stainless steel. Add suffix “C” to part number and delete prefix “63” or “38”

Note: Sleeve part number 900568-(size)

Hose fittings – Reusable

For use with PTFE hose:
2807, SC-TW, S -TW

PTFE hose

“Super gem”

SAE 45° swivel

63-190990-

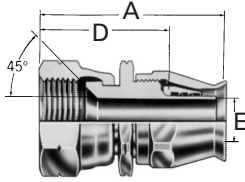

Dash size	Hose size	Thread	A		D		EØ	
			mm	in	mm	in	mm	in
63-190990-								
4	-04	7/16-20	40,1	1.58	28,4	1.12	4,1	0.16
5	-05	1/2-20	42,7	1.68	29,7	1.17	5,8	0.23
6	-06	5/8-18	45,0	1.77	31,8	1.25	7,1	0.28
8	-08	3/4-16	50,8	1.98	34,5	1.36	9,7	0.38
10	-10	7/8-14	56,4	2.22	39,1	1.54	11,9	0.47
12	-12	1 1/16-14	59,2	2.33	42,4	1.67	15,0	0.59

45° elbow universal

190773-

SAE 45° swivel

FC9341-

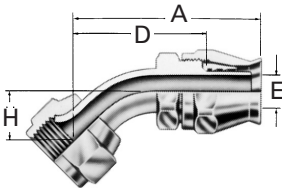

Dash size	Hose Size	Thread	A		D		EØ		H	
			mm	in	mm	in	mm	in	mm	in
190773-										
3S	-03	3/8-24	38,1	1.50	29,7	1.17	2,3	0.09	11,7	0.46
4S	-04	7/16-20	38,4	1.51	26,7	1.05	4,1	0.16	8,4	0.33
5S	-05	1/2-20	41,1	1.62	28,2	1.11	5,8	0.23	9,1	0.36
6S†	-06	9/16-18	43,7	1.72	30,5	1.20	7,1	0.28	9,9	0.39
8S	-08	3/4-16	57,7	2.27	41,7	1.64	9,7	0.38	14,0	0.55
10S	-10	7/8-14	62,5	2.46	45,5	1.79	11,9	0.47	16,3	0.64
12S†	-12	1 1/16-12	72,6	2.86	56,1	2.21	15,0	0.59	19,8	0.78
16S†	-16	1 5/16-12	83,8	3.30	68,1	2.68	21,1	0.83	27,2	1.07
20S	-20	1 5/8-12	96,5	3.80	79,8	3.14	26,9	1.06	31,0	1.22
FC9341-										
0606S	-06	5/8-18	43,7	1.72	30,5	1.20	7,1	0.28	9,9	0.39
1212S	-12	1 1/16-14	72,6	2.86	56,1	2.21	15,0	0.59	19,8	0.78

Universal

190772-

SAE 45° swivel

FC9171-

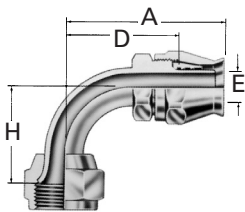

Dash size	Hose Size	Thread	A		D		EØ		H	
			mm	in	mm	in	mm	in	mm	in
190772-										
3S	-03	3/8-24	32,3	1.27	23,6	0.93	2,3	0.09	22,1	0.87
4S	-04	7/16-20	35,8	1.41	24,1	0.95	4,1	0.16	17,3	0.68
5S	-05	1/2-20	38,6	1.52	25,4	1.00	5,8	0.23	19,6	0.77
6S†	-06	9/16-18	41,1	1.62	27,9	1.10	7,1	0.28	21,6	0.85
8S	-08	3/4-16	51,6	2.03	35,8	1.41	9,7	0.38	27,7	1.09
10S	-10	7/8-14	54,9	2.16	37,8	1.49	11,9	0.47	31,2	1.23
10-12S	-12	7/8-14	56,6	2.23	39,9	1.57	11,7	0.46	31,2	1.23
12S†	-12	1 1/16-12	71,6	2.82	55,1	2.17	15,0	0.59	46,2	1.82
12-16S†	-16	1 1/16-14	72,9	2.87	56,4	2.22	14,7	0.58	46,2	1.82
16S†	-16	1 5/16-12	78,7	3.10	63,2	2.49	20,8	0.82	60,7	2.39
FC9171-										
0606S	-06	5/8-18	41,1	1.62	27,9	1.10	7,1	0.28	21,6	0.85
1212S	-12	1 1/16-14	71,1	2.80	55,6	2.19	15,0	0.59	46,2	1.82

†SAE 37° (JIC) swivel only

Universal type identification for both SAE 45° and 37° connections.

Note: Sleeve part number 900568-(size).

For correct socket information see page I-3.

“Super gem”

2-bolt swivel flange 63-190626-

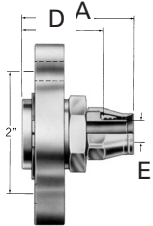

Dash size	Flange head dia.		Hose size	A		D		EØ	
	mm	in		mm	in	mm	in	mm	in
63-190626-									
6	73,2	2.88	-06	45,2	1.78	32,0	1.26	7,1	0.28
12	73,2	2.88	-12	52,6	2.07	36,1	1.42	14,2	0.56
16	73,2	2.88	-16	55,4	2.18	37,8	1.49	4,8	0.19

Compression ball sleeve 38-191074-

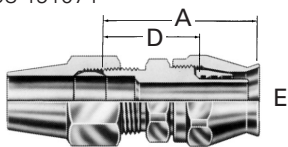

Dash size	Tube size.	Hose size	A		D		EØ	
			mm	in	mm	in	mm	in
38-191074-								
8	-08	-08	42,2	1.66	26,4	1.04	9,7	0.38
10	-10	-10	47,0	1.85	30,0	1.18	11,9	0.47
12	-12	-12	52,8	2.08	35,8	1.41	15,0	0.59

SAE ball sleeve* 190718-

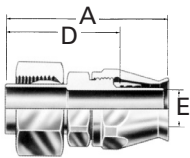

Dash size	Hose size	Thread size	A		D		EØ	
			mm	in	mm	in	mm	in
190718-								
8S	-08	11/16-20	52,6	2.07	36,6	1.44	9,7	0.38
10-8S	-08	13/16-18	52,6	2.07	36,6	1.44	9,7	0.38
10S	-10	13/16-18	54,9	2.16	37,8	1.49	12,2	0.48
12S	-12	1-18	61,5	2.42	44,7	1.76	15,0	0.59

Special ball sleeve* 190742-

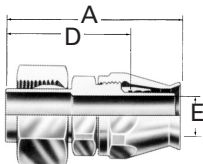

Dash size	Hose size	Thread size	A		D		EØ	
			mm	in	mm	in	mm	in
190742-								
10S	-10	7/8-18	54,9	2.16	37,8	1.49	12,2	0.48

*Some B-W compressor adapters require special mating nuts. For 13/16"-18 thread size for 1/2" O.D. tubing, use fitting 190718-10-8S with 2807-8 Hose.

For special thread size 7/8"-18, use fitting 190742-10S with 2807-10 Hose.

Note: Sleeve part number 900568-(size).

SAE male inverted flare straight FC9062-

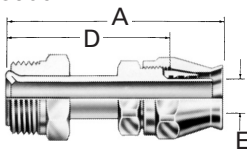

Dash size	Hose size	Thread size	A		D		EØ	
			mm	in	mm	in	mm	in
FC9062-								
0404S	-04	7/16-24	54,1	2.13	42,2	1.66	4,1	0.16
0505S	-05	1/2-20	55,1	2.17	42,2	1.66	5,8	0.23
0506S	-06	1/2-20	56,1	2.21	42,9	1.69	5,3	0.21
0606S	-06	5/8-18	56,1	2.21	42,9	1.69	7,1	0.28
0808S	-08	3/4-18	62,7	2.47	46,7	1.84	9,7	0.38
1010S	-10	7/8-18	70,6	2.78	53,6	2.11	11,9	0.47
1212S	-12	1 1/16-16	76,7	3.02	60,2	2.37	15,0	0.59

†SAE 37° (JIC) swivel only

Universal type identification for both SAE 45° and 37° connections.

Note: Sleeve part number 900568-(size).

For correct socket information see page I-3.

Hose fittings – Reusable

For use with PTFE hose:
2807, FC465, S -TW

PTFE hose

“Super gem”

SAE male inverted flare 45° elbow

FC9063-

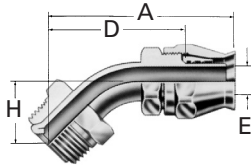

Dash size	Hose size	Thread	A		D		EØ		H	
			mm	in	mm	in	mm	in	mm	in
FC9063-										
0505S	-05	1/2-20	62,5	2.46	49,3	1.94	5,8	0.23	24,4	0.96
0506S	-06	1/2-20	63,5	2.50	50,0	1.97	5,3	0.21	24,4	0.96
0606S	-06	5/8-18	63,5	2.50	50,0	1.97	7,1	0.28	24,4	0.96
0808S	-08	3/4-18	67,6	2.66	51,8	2.04	9,7	0.38	23,6	0.93
1010S	-10	7/8-18	75,2	2.96	58,2	2.29	11,9	0.47	26,2	1.03
1212S	-12	1 1/16-16	78,7	3.10	62,0	2.44	15,0	0.59	27,9	1.10

SAE male inverted flare 90° elbow

190950-

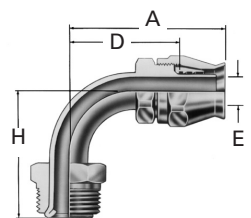

Dash size	Hose size	Thread	A		D		EØ		H	
			mm	in	mm	in	mm	in	mm	in
190950-										
4S	-04	7/16-24	51,8	2.04	39,9	1.57	4,1	0.16	42,9	1.69
5S	-05	1/2-20	52,8	2.08	39,9	1.57	5,8	0.23	42,9	1.69
5-6S	-06	1/2-20	53,8	2.12	40,6	1.60	5,3	0.21	42,9	1.69
6S	-06	5/8-18	53,8	2.12	40,6	1.60	7,1	0.28	43,9	1.73
8S	-08	3/4-18	58,9	2.32	42,9	1.69	9,7	0.38	44,2	1.74
10S	-10	7/8-18	67,6	2.66	50,5	1.99	11,9	0.47	56,1	2.21
12S	-12	1 1/16-16	69,3	2.73	52,6	2.07	15,0	0.59	59,7	2.35

Male pipe

38-190628-

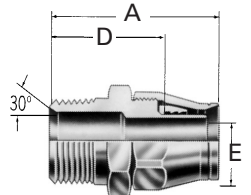

Dash size	Hose size	Thread	A		D		EØ	
			mm	in	mm	in	mm	in
38-190628-								
6-8	-08	3/8-18	48,5	1.91	33,5	1.32	8,9	0.35
8-10	-10	1/2-14	53,8	2.12	39,4	1.55	11,2	0.44
12-12	-12	3/4-14	60,9	2.40	41,4	1.63	14,2	0.56
16-16	-16	1-11 1/2	66,8	2.63	47,2	1.86	21,1	0.83
20-20	-20	1 1/4-11 1/2	77,5	3.05	53,1	2.09	26,9	1.06
24-24	-24	1 1/2-11 1/2	80,2	3.16	55,9	2.20	32,5	1.28

SAE 37° (JIC) swivel

63-190535-

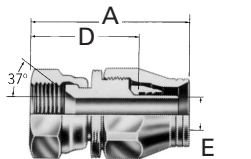

Dash size	Hose size	Thread	A		D		EØ	
			mm	in	mm	in	mm	in
63-190535-								
8	-08	3/4-16	52,6	2.07	37,6	1.48	8,9	0.35
10	-10	7/8-14	56,4	2.22	41,7	1.64	11,2	0.44
12	-12	1 1/16-12	62,5	2.46	43,8	1.70	14,2	0.56
16	-16	1 5/16-12	67,6	2.66	48,3	1.90	21,1	0.83
20	-20	1 5/8-12	79,8	3.14	55,6	2.19	26,9	1.06
24	-24	1 7/8-12	85,9	3.38	61,5	2.42	32,5	1.28

†SAE 37° (JIC) swivel only
Universal type identification for both SAE 45° and 37° connections.

Note: Sleeve part number 900568-(size).
For correct socket information see page I-3.

Split flanges

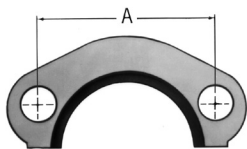
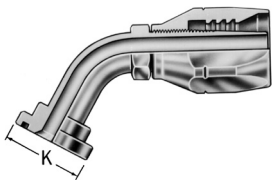

Split flanges

Eaton has standard pressure series (code 61) and high pressure series (code 62) split flange components in kit form that save time in selecting and ordering. Each kit includes two flange halves, four grade-8 hex bolts, four lock washers and an O-Ring. The standard kit has a Buna-N 90 durometer O-Ring that is compatible with petroleum and water-base hydraulic fluids. Optional kits contain EPDM and Viton* O-Ring for applications where fluid compatibility or high temperatures require other than Buna-N O-Ring.

*Viton is a trademark of The Chemours Company FC, LLC.

Two methods can be used to determine the flange dash size and code. The first is by measuring the flange head diameter on the fitting itself. This is referred to as the “K” dimension. The second is by measuring the “A” dimension on the flange or the flange port. Either will determine the dash size and the code since these dimensions are exclusive to either code 61 or code 62 split flange kits. See chart below for these dimensions.

In some cases, split flange fittings are available for hoses which exceed the pressures listed; when ordering fittings or hose assemblies, the terminal end performance rating may reduce the overall rating of the assembly.

“A” Dim.	“K” Flange head diameter	Flange dash size	Maximum operating pressure*		Recommended bolt torque
			in	psi	
in	in	mm	bar	psi	lb-in
Code 61					
1.50	1.19	-08	350,0	5000	175–225
1.88	1.50	-12	350,0	5000	225–350
2.06	1.75	-16	350,0	5000	325–425
2.31	2.00	-20	280,0	4000	425–550
2.75	2.38	-24	210,0	3000	550–700
3.06	2.81	-32	210,0	3000	650–800
3.50	3.31	-40	175,0	2500	950–1100
4.19	4.00	-48	140,0	2000	1650–1800
Code 62					
1.59	1.25	-08	420,0	6000	175–225
2.00	1.63	-12	420,0	6000	300–400
2.25	1.88	-16	420,0	6000	500–600
2.62	2.12	-20	420,0	6000	750–900
3.12	2.50	-24	420,0	6000	1400–1600
3.81	3.12	-32	420,0	6000	2400–2600

*Per SAE J518 standard.

Assembly procedure

Many leakage problems can be avoided if the split flanges are properly assembled.

To properly assemble

1. Clean all mating surfaces.
2. Lubricate the O-Ring.
3. Partially tighten each bolt in rotation until all are fully tightened to the recommended torque value.

How to order

1. Determine the dash size and the code.
2. Select O-Ring for fluid compatibility.
3. Order by kit number shown on pages I-62 to I-63.

Hose fittings – Reusable

Split flange kits

Split flange kits

SAE standard pressure series (Code 61) SAE J518

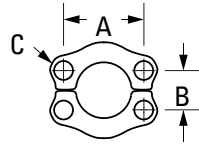
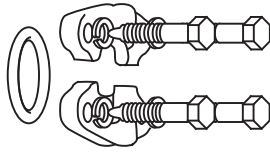

O-Rings material:
Buna-N 90 Durometer

Temperature range:
-40°F to +250°F
(-40°C to + 121°C)

Nominal flange size	Complete kit	*Flange halves 2 required	*Buna-N O-Ring 1 required	*Bolts 4 required	*Lock washer 4 required	A	B	C	Bolt torque lb.-in
1/2	FF593-08	449-74446-8	FF9446-210	FF9442-0520-94	210104-5S	1.50	0.68	0.34	175-225
3/4	FF593-12	449-74446-12	FF9446-214	FF9442-0620-94	210104-6S	1.88	0.88	0.41	250-350
1	FF593-16	449-74446-16	FF9446-219	FF9442-0620-94	210104-2-6S	2.06	1.04	0.41	325-425
1-1/4	FF593-20	449-74446-20	FF9446-222	FF9442-0724-94	210104-7S	2.31	1.18	0.48	425-550
1-1/2	FF593-24	449-74446-24	FF9446-225	FF9442-0824-94	210104-8S	2.75	1.40	0.53	550-700
2	FF593-32	449-74446-32	FF9446-228	FF9442-0824-94	210104-8S	3.06	1.68	0.53	650-800
2-1/2	FF593-40	449-74446-40	FF9446-232	FF9442-0828-94	210104-8S	3.50	2.00	0.53	950-1100
3	FF593-48	449-74446-48	FF9446-237	FF9442-1028-94	210104-10S	4.19	2.44	0.66	1650-1800

* Included in kit.

*Viton kit available as part # FF687-Size. EPDM kit available as part # FF688-size.

Note: All measurements in inches.

SAE high pressure series (Code 62) SAE J518

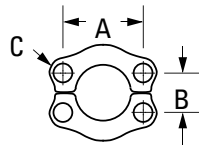
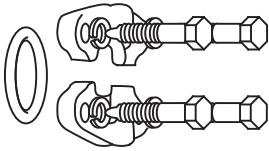

O-Ring material:
Buna-N 90 Durometer

Temperature range:
-40°F to +250°F
(-40°C to + 121°C)

Note: Code 62 split flange kits cannot be used with Cat flange fittings. Use existing split flanges.

Nominal flange size	Complete kit	*Flange halves 2 required	*Buna-N O-Ring 1 required	*Bolts 4 required	*Lock washer 4 required	A	B	C	Bolt torque lb.-in
3/4	FF595-12	FC3425-12-449	FF9446-214	FF9442-0624-94	210104-6S	2.00	0.94	0.42	300-400
1	FF595-16	FC3425-16-449	FF9446-219	FF9442-0728-94	210104-7S	2.25	1.10	0.50	500-600
1-1/4	FF595-20	FC3425-20-449	FF9446-222	FF9442-0828-94	210104-8S	2.62	1.24	0.60	750-900
1-1/2	FF595-24	FC3425-24-449	FF9446-225	FF9442-1036-94	210104-10S	3.12	1.44	0.66	1400-1600
2	FF595-32	FC3425-32-449	FF9446-228	FF9442-1244-94	210104-12S	3.81	1.76	0.78	2400-2600

* Included in kit.

* Viton kit available as part #FF689-size.

Note: All measurements in inches.

Viton is a trademark of The Chemours Company FC, LLC.

Split flange kits

4 hole flange SAE standard pressure series (Code 61) SAE J518

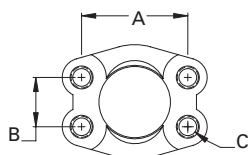

Nominal flange size	4 bolt flange	A	B	C (Threaded)
3/4	FC2119-12-449	1.88	0.88	3/8-16
1	FC2119-16-449	2.06	1.03	7/16-14
1-1/4	FC2119-20-449	2.31	1.19	3/8-16
1-1/2	FC2119-24-449	2.75	1.41	1/2-13
2	FC2119-32-449	3.06	1.69	1/2-13
2-1/2	FC2119-40-449	3.50	2.00	1/2-13

*Available without threads as part #FC3459-size-449.

Note: All measurements in inches.

O-Ring for SAE J518 Split flange

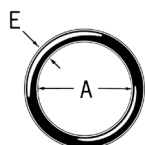

O-Ring base number	Material	Operating temperature range
FF9016 EPDM	80 Durometer	-65°F to +300°F (-55°C to +150°C)
FF9446 Buna-N	90 Durometer Buna-N	-40°F to +250°F (-40°C to +121°C)
22046 Viton	90 Durometer	-15°F to +400°F (-25°C to +205°C)

Available without threads part #FC3459-size-449.

O-Ring dash size designation	Flange dash size	Nominal flange size	A		E	
			mm	in	mm	in
-210	08	1/2	18,5	0.734	3,5	0.139
-214	12	3/4	24,9	0.984	3,5	0.139
-219	16	1	32,9	1.296	3,5	0.139
-222	20	1 1/4	37,7	1.484	3,5	0.139
-225	24	1 1/2	47,2	1.859	3,5	0.139
-228	32	2	56,7	2.234	3,5	0.139
-232	40	2 1/2	69,4	2.734	3,5	0.139
-237	48	3	85,3	3.359	3,5	0.139

Viton is a trademark of The Chemours Company FC, LLC.

Hose fittings – Reusable

O-Rings and kits

O-Rings

Cat flange D-Ring*

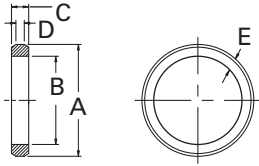

Part number	A		B		C		D		E	
	mm	in	mm	in	mm	in	mm	in	mm	in
FF90319-12	32,3	1.27	25,4	1.00	5,1	0.20	2,5	0.10	3,6	0.14
FF90319-16	38,6	1.52	31,8	1.25	5,1	0.20	2,5	0.10	3,6	0.14
FF90319-20	45,0	1.77	38,1	1.50	5,1	0.20	2,5	0.10	3,6	0.14
FF90319-24	51,6	2.03	44,7	1.76	5,1	0.20	2,5	0.10	3,6	0.14
FF90319-32	70,6	2.78	64,0	2.52	5,1	0.20	2,5	0.10	3,6	0.14

Temperature range: -40°F to +212°F.

Material: Nitrile (Buna-N).

*To be used only with Cat flange.

O-Rings for bump tube O-Ring seal and O-Ring pilot fitting

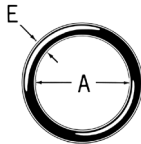

Part number	O-Ring pilot dash size	A		E	
		mm	in	mm	in
22546-11	-06	7,6	0.30	1,8	0.07
22546-13	-08	10,9	0.43	1,8	0.07
22546-15	-10	14,0	0.55	1,8	0.07
22546-17	-12	17,3	0.68	1,8	0.07

O-Rings and kits

O-Ring seal kit FF16087-01

Includes: metal box,
O-Rings for ORS -4 through -24,
O-Ring boss -04 through -32,
Split flange -08 through -32,
24 packages with twelve
90 durometer nitrile
O-Ring per package.
Replacement O-Ring can be
ordered individually by
part number listed.



FF16087-01

Connection	Size	Individual O-Ring part no.
ORS	-04	FF9446-11
ORS	-06	FF9446-12
ORS	-08	FF9446-14
ORS	-10	FF9446-16
ORS	-12	FF9446-18
ORS	-16	FF9446-21
ORS	-20	FF9446-25
ORS	-24	FF9446-29
O-Ring Boss	-04	22617-4
O-Ring Boss	-05	22617-5
O-Ring Boss	-06	22617-6
O-Ring Boss	-08	22617-8
O-Ring Boss	-10	22617-10
O-Ring Boss	-12	22617-12
O-Ring Boss	-16	22617-16
O-Ring Boss	-20	22617-20
O-Ring Boss	-24	22617-24
O-Ring Boss	-32	22617-32
Split Flange	-08	FF9446-210
Split Flange	-12	FF9446-214
Split Flange	-16	FF9446-219
Split Flange	-20	FF9446-222
Split Flange	-24	FF9446-225
Split Flange	-32	FF9446-228

BSPP bonded seal for DIN 3852-2 ports

FF9895

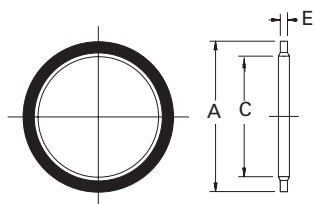

Bonded seal part number	BSPP thread size	A Ref	C Ref	E Ref
		inch	inch	inch
FF9895-02	1/8-28	0.625	0.403	0.080
FF9895-04	1/4-19	0.810	0.536	0.080
FF9895-06	3/8-19	0.937	0.675	0.080
FF9895-08	1/2-14	1.125	0.843	0.097
FF9895-10	5/8-14	1.250	0.920	0.097
FF9895-12	3/4-14	1.375	1.060	0.097
FF9895-16	1-11	1.685	1.329	0.133
FF9895-20	1 1/4-11	2.062	1.685	0.133
FF9895-24	1 1/2-11	2.307	1.902	0.133
FF9895-32	2-11	2.875	2.380	0.133

Material: Steel with bonded Nitrile (Buna-N) seal.

Hose fittings – Reusable

O-Ring and kits

Designating separate SAE O-Ring boss

To order Eaton O-Ring separately without fittings specify the size and material by using the O-Ring base number and dash size. The charts offer a simple method to assure the correct O-Ring for your application.

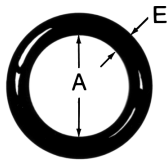

O-Ring base no.	Material	Operating temperature range
22617 (Standard)	Buna-N Nitrile rubber 90 Durometer	-30°F to +250°F (-34°C to +121°C)
22033	EPDM Ethylene propylene diene monomer	-65°F to +212°F (-55°C to +100°C)
22068	Viton Fluoroelastomer 90 Durometer	-15°F to +400°F (-25°C to +205°C)
22012	Buna-N, Low temperature nitrile rubber 90 Durometer	-65°F to +225°F (-55°C to +107°C)

O-Ring dash size	Tube size	A		E	
		mm	in	mm	in
-4	-04 (1/4)	8,9	0.351	1,8	0.072
-6	-06 (3/8)	11,9	0.468	2,0	0.078
-8	-08 (1/2)	16,3	0.644	2,3	0.087
-10	-10 (5/8)	19,3	0.755	2,5	0.097
-12	-12 (3/4)	23,4	0.924	3,0	0.116
-16	-16 (1)	29,7	1.171	3,0	0.116
-20	-20 (1 1/4)	37,6	1.475	3,0	0.118
-24	-24 (1 1/2)	43,7	1.720	3,0	0.118

Designating separate ORS O-Ring

To order Eaton O-Ring separately without fittings specify the size and material by using the O-Ring designator and O-Ring base number. The charts to the right offer a simple method to assure the correct O-Ring for your application.

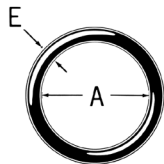

O-Ring base no.	Material	Operating temperature range
FF9446 (Standard)	Buna-N Nitrile Rubber 90 Durometer	-40°F to +250°F (-40°C to +121°C)
FF9807	EPDM Ethylene propylene diene monomer	-65°F to +300°F (-55°C to +150°C)
22046	Viton Fluoroelastomer 90 Durometer	-15°F to +400°F (-25°C to +205°C)
FF9855	Buna-N, Low Temperature Nitrile Rubber 90 Durometer	-65°F to +225°F (-55°C to +107°C)
22546	Neoprene 90 Durometer	-65°F to +300°F (-55°C to +150°C)

O-Ring dash size	Tube size	A		E	
		mm	in	mm	in
-11	-04	7,6	0.301	1,8	0.07
-12	-06	9,2	0.364	1,8	0.07
-14	-08	12,4	0.489	1,8	0.07
-16	-10	15,6	0.614	1,8	0.07
-18	-12	18,8	0.739	1,8	0.07
-21	-16	23,5	0.926	1,8	0.07
-25	-20	29,9	1.176	1,8	0.07
-29	-24	37,8	1.489	1,8	0.07

Viton is a trademark of The Chemours Company FC, LLC.

Adapters and tube fittings

Configuration index	J-4	SAE O-Ring boss to 37° flare	J-76
Application data and part structure	J-12	SAE split flange to ORS.	J-81
ORS-TF	J-17	SAE split flange to 37° flare	J-84
ORS-Braze type.	J-18	SAE swivel flange to SAE split flange.	J-87
ORS/SAE O-Ring boss	J-21	SAE flareless to 37° union.	J-88
ORS-NPTF.	J-26	Braze and weld to split flange	J-89
ORS to SAE 37° flare	J-28	Braze and weld to 37° flare	J-90
ORS/ORS.	J-29	Versil-Flare – flareless and flare	J-92
ORS accessories	J-32	Specials	J-94
SAE O-Ring boss/SAE O-Ring boss	J-33	Metric to 37° flare	J-95
Pipe to pipe	J-38	ORS to metric	J-98
Pipe to 37° flare.	J-50	BSPP to 37° flare.	J-99
Pipe to 45° flare.	J-62	BSPT to 37° flare.	J-100
Pipe to SAE O-Ring boss	J-64	JIS 30° to 37° flare	J-100
Pipe to braze and weld	J-67	Stainless steel adapters.	J-101
SAE 37° (JIC) flare union	J-68	7000 series Ermeto	J-107
SAE 45° flare	J-75	Plastic bags	J-120



Adapters and tube fittings

Configuration index

J

ORS-TF

FC1851
Page J-17

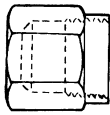

FF90102
Page J-17



FF90103
Page J-17



ORS braze type

FC1229
Page J-18

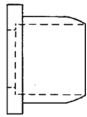

FC2325
Page J-18

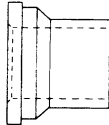

FF1922T
Page J-19

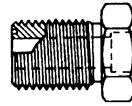

FF1851T
Page J-19



ORS braze type (cont.)

FF1856T
Page J-20

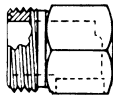

FF1858T
Page J-20

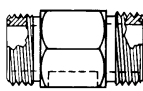

FF2115T
Page J-20

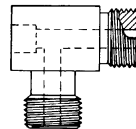

FC2326
Page J-20



ORS/SAE O-Ring boss

F2211T
Page J-21



FF1854T
Page J-21

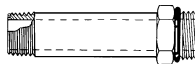

FF2130T
Page J-21

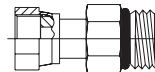

FF1852T
Page J-22

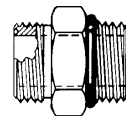

ORS/SAE O-Ring boss (cont.)

FF1868T
Page J-22

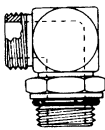

FF2227T
Page J-23

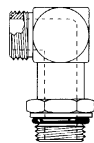

FF2068T
Page J-24



ORS/SAE O-Ring boss (cont.)

FF1861T
Page J-25

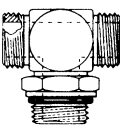

FF1865T
Page J-25

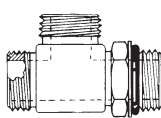

ORS-NPTF

FF2031T
Page J-26

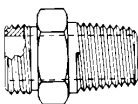

FF2093T
Page J-26

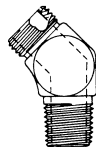

FF2032T
Page J-27

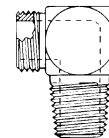

FF2001T
Page J-27

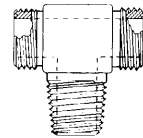

ORS to SAE 37° (JIC) flare

FF2209T
Page J-28

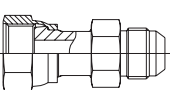

FF2313T
Page J-28

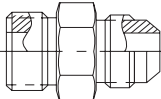

ORS/ORS

FF2000T
Page J-28

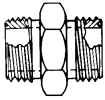

FF2281T
Page J-29

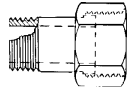

FF1994T
Page J-29

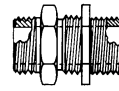

FF2133T
Page J-29

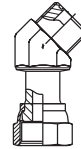

ORS/ORS (cont.)

FF2144T
Page J-30

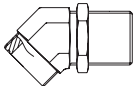

FF2098T
Page J-30

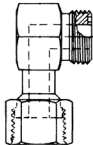

FF2035T
Page J-30

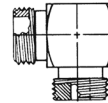

ORS/ORS (cont.)

FF2030T
Page J-31

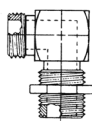

FF1898T
Page J-31

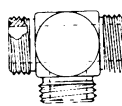

FF2174T
Page J-31

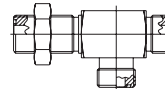

ORS/ORS (cont.)

FF1857T
Page J-32

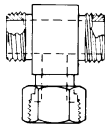

FF2114T
Page J-32

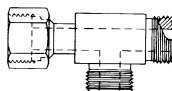

FF2033T
Page J-32

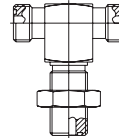

ORS accessories

FF9768
Page J-33



FF9767
Page J-33

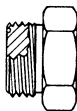

FF9863
Page J-33

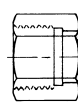

ORS accessories (cont.)

FF9766
Page J-34

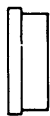

FF9075
ORS silver
braze ring
Page J-34



SAE O-Ring boss/SAE O-Ring boss

FF1010
Page J-35



900598
Page J-36



FF2138
Page J-36

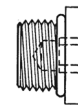

2220
Page J-36

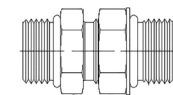

SAE O-Ring boss/SAE O-Ring boss

2229
Page J-37

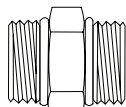

FF2591
Page J-37

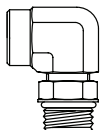

FF1167
Page J-37

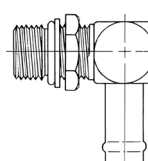

Adapters and tube fittings

Configuration index

J

Pipe to pipe

2083
Page J-38

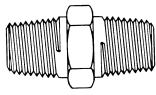

2015
Page J-38

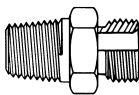

2084
Page J-39



2081
Page J-39

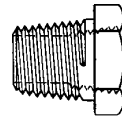

Pipe to pipe (cont.)

2082
Page J-40

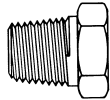

2222
Page J-40

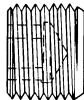

2040
Page J-40

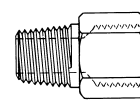

2045
Page J-41

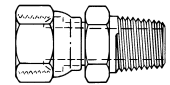

Pipe to pipe (cont.)

2046
Page J-41

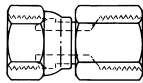

2096
Page J-42

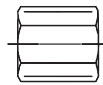

2247
Page J-42

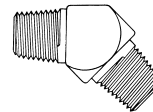

2050
Page J-42

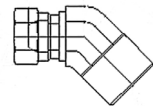

Pipe to pipe (cont.)

2049
Page J-43

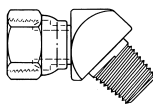

2088
Page J-43

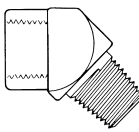

2085
Page J-43

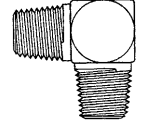

FF1162
Page J-44

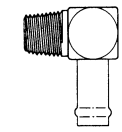

Pipe to pipe (cont.)

2251
Page J-44

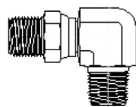

2089
Page J-44

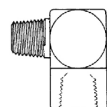

2252
Page J-45

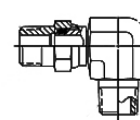

2048
Page J-45

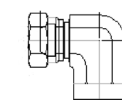

Pipe to pipe (cont.)

2047
Page J-46

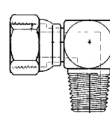

2087
Page J-46

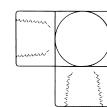

2257
Page J-47

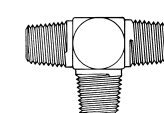

2256
Page J-47

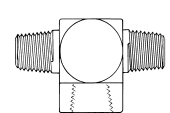

Pipe to pipe (cont.)

2093
Page J-47

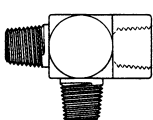

2092
Page J-47

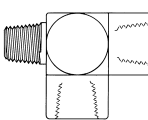

2254
Page J-48

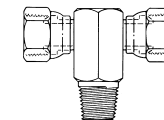

2255
Page J-48

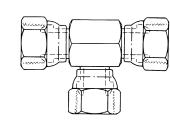

Pipe to pipe (cont.)

2253
Page J-48

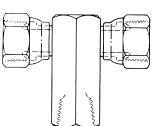

2091
Page J-48

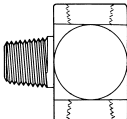

2090
Page J-49

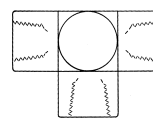

2080
Page J-49

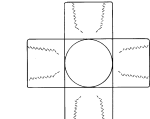

Pipe to 37° flare

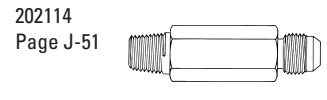
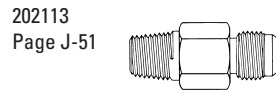
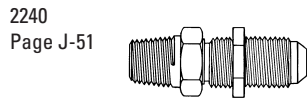
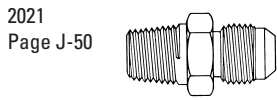

Pipe to 37° flare (cont.)

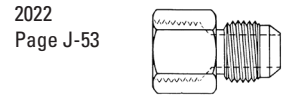
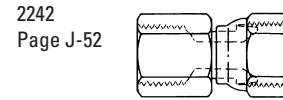
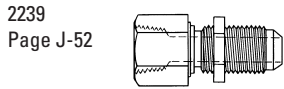

Pipe to 37° flare (cont.)

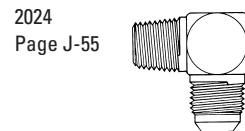
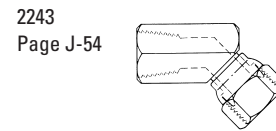
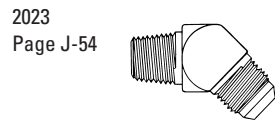
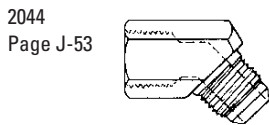

Pipe to 37° flare (cont.)

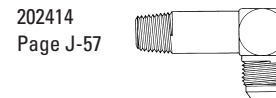
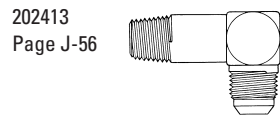
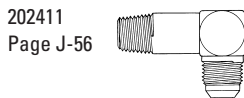

Pipe to 37° flare (cont.)

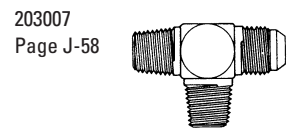
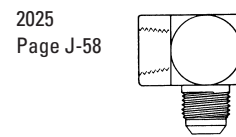
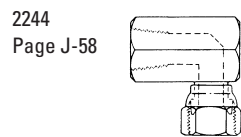
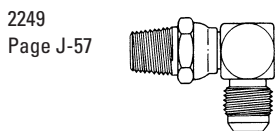

Pipe to 37° flare (cont.)

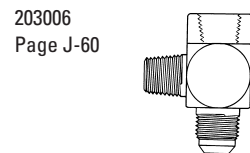
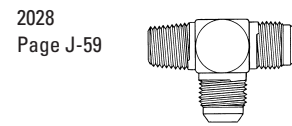
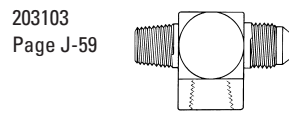
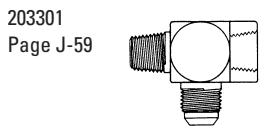

Pipe to 37° flare (cont.)

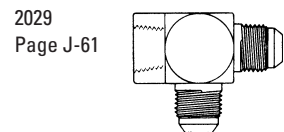
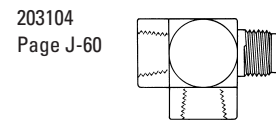
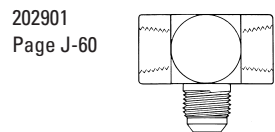
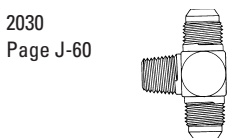

Pipe to 37° flare (cont.)

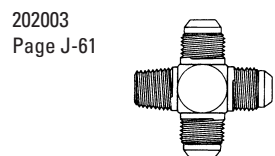
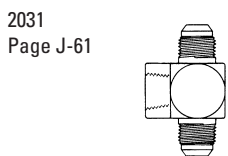

Adapters and tube fittings

Configuration index

J

Pipe to 45° flare

2000
Page J-62

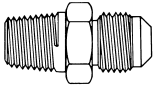

2001
Page J-62

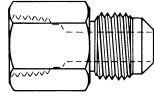

2007
Page J-63

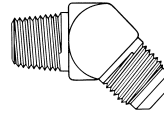

2003
Page J-63

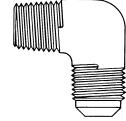

Pipe to 45° flare (cont.)

2002
Page J-63

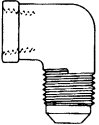

Pipe to SAE O-Ring boss

2246
Page J-64

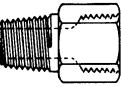

2066
Page J-64

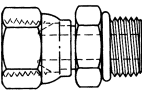

2216
Page J-65

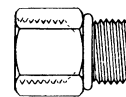

2067
Page J-65

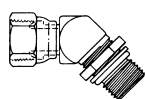

Pipe to SAE O-Ring boss (cont.)

2068
Page J-66

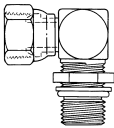

206801
Page J-66

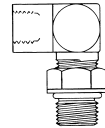

206804
Page J-66

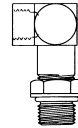

Pipe to braze and weld

73056
Page J-67

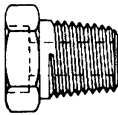

FF1159
Page J-67



SAE 37° (JIC) flare union

2027
Page J-67

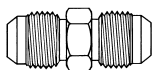

202712
Page J-68

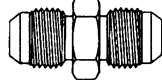

2041
Page J-68

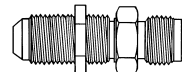

900599
Page J-68

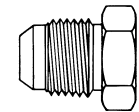

SAE 37° (JIC) flare union (cont.)

210292
Page J-69

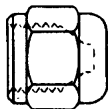

2215
Page J-69

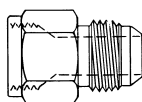

221501
Page J-70

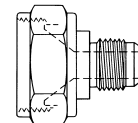

2042
Page J-70

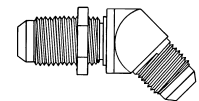

SAE 37° (JIC) flare union (cont.)

2070
Page J-70

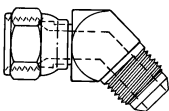

2039
Page J-71

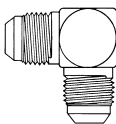

2043
Page J-71

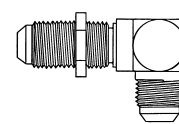

2071
Page J-71

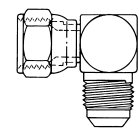

SAE 37° (JIC) flare union (cont.)

FF5163
Page J-72

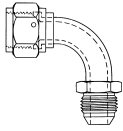

500454
Page J-72

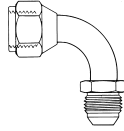

504095
Page J-72

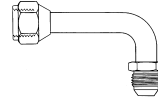

FF5164
Page J-73

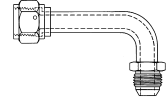

SAE 37° (JIC) flare union (cont.)

2033
Page J-73

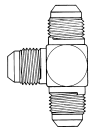

203002
Page J-73

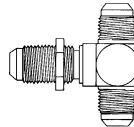

203008
Page J-74

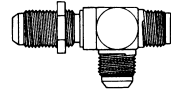

203101
Page J-74

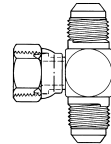

SAE 37° (JIC) flare union (cont.)

203102
Page J-74

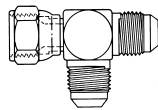

2020
Page J-75

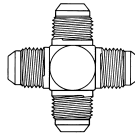

210212
Page J-75



SAE 45° flare union

2056
Page J-75

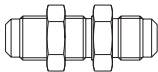

2060
Page J-75

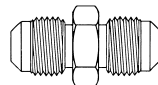

SAE O-Ring to 37° flare

202702
Page J-76-77

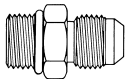

202713
Page J-77



2266
Page J-77

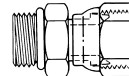

2061
Page J-78

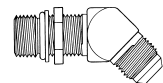

SAE O-Ring to 37° flare (cont.)

206209
Page J-78

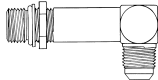

2214
Page J-78

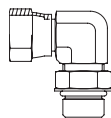

2062
Page J-79

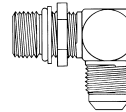

SAE O-Ring to 37° flare (cont.)

203005
Page J-80

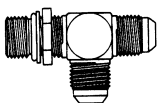

203003
Page J-80

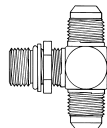

SAE split flange to ORS

FF5943T
Page J-81

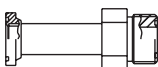

FF6001T
Page J-81

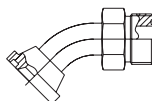

FF6002T
Page J-81

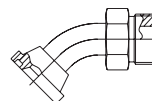

Adapters and tube fittings

Configuration index

J

SAE split flange to ORS (cont.)

FF5946T
Page J-82

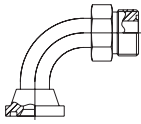

FF5945T
Page J-82

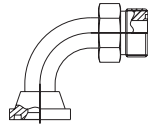

FF6062T
Page J-82

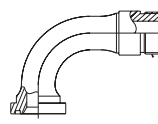

FF6064T
Page J-82

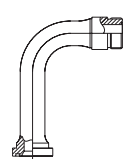

SAE split flange to ORS (cont.)

FF6071T
Page J-83

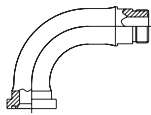

FF6072T
Page J-83

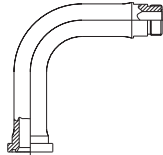

SAE split flange to ORS (cont.)

FF6073T
Page J-83

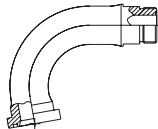

FF2522T
Page J-83

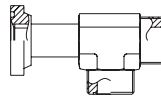

SAE split flange to 37° flare

500025
Page J-84

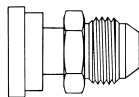

FF5239
Page J-84

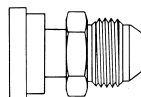

FF5541
Page J-84

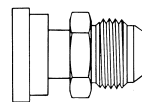

FF5539
Page J-85

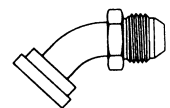

SAE split flange to 37° flare (cont.)

500023
Page J-85

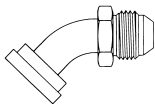

FF5238
Page J-85

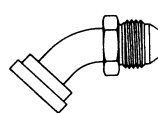

500024
Page J-86

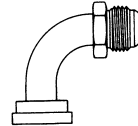

FF5162
Page J-86

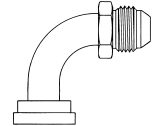

SAE split flange to 37° flare (cont.)

FF5540
Page J-87

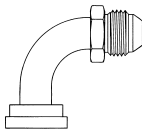

SAE swivel flange to SAE split flange

504089
Page J-87

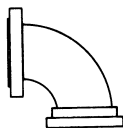

FF5321
Page J-87

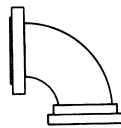

SAE flareless to 37° union

FF1315
Page J-88

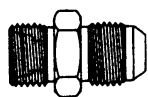

210294
Page J-88

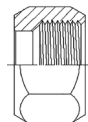

FF9173
Page J-88

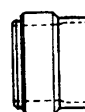

Braze and weld to split flange (cont.)

71418
Page J-89

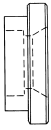

4624
Page J-89

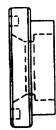

Braze and weld to split flange (cont.)

71416
Page J-90

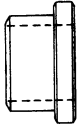

71422
Page J-90

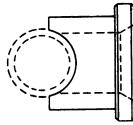

FC1102
Page J-90



FC1132
Page J-90



Braze and weld to 37° flare

202232
Page J-91

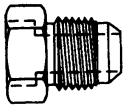

73014
Page J-91

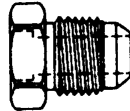

Versil-flare™ - flareless and flare

FC2875
Page J-92

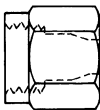

FF9605
Page J-92

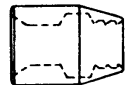

1290
Page J-93

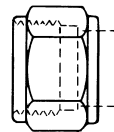

900605
Page J-93

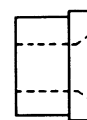

Specials

2004
Page J-94

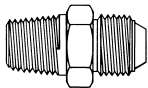

202124/FF1327
Page J-94

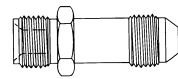

200001
Page J-94

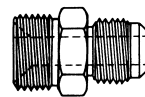

FT1353/FF1354
Page J-94

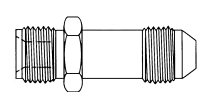

Specials (cont.)

FF1980
Page J-95

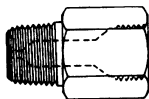

FF1981
Page J-95

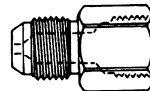

Metric to 37° flare

15.063
Page J-95

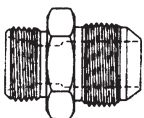

15.147
Page J-95

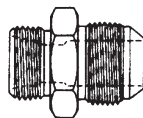

15.117
Page J-96

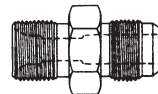

15.164
Page J-96

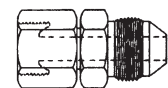

Adapters and tube fittings

Configuration index

J

Metric to 37° flare (cont.)

15.163
Page J-96

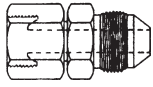

15.165
Page J-97

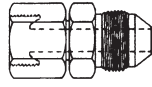

GG108-NP
Page J-97

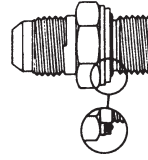

GG308-NP
Page J-97

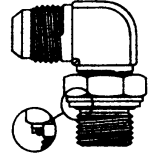

ORS to metric

FF2485T
Page J-98

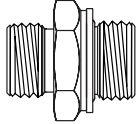

FF2742T
Page J-98

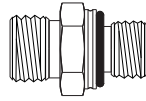

FF2743T
Page J-98

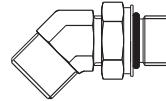

FF2744T
Page J-98

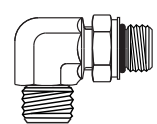

ORS to metric (cont.)

FF2746T
Page J-98

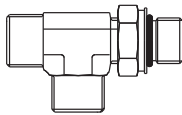

BSPB thread

2063
Page J-99

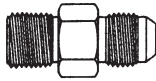

GG106-NP
Page J-99

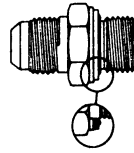

GG306-NP
Page J-100

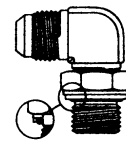

GG110-NP
Page J-100



BSPT thread

GG310-NP
Page J-100

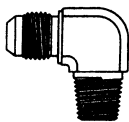

JIS 30° thread

FF2593
Page J-100

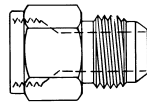

Stainless steel

259-2081
Page J-102

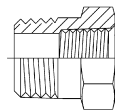

259-2082
Page J-102

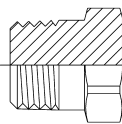

259-2083
Page J-103

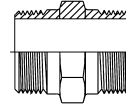

259-2096
Page J-103

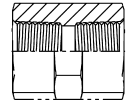

Stainless steel (cont.)

259-2021
Page J-104

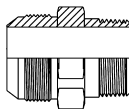

259-2240
Page J-104

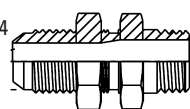

259-2022
Page J-104

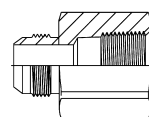

259-2027
Page J-105

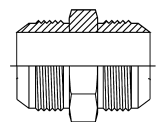

Stainless steel (cont.)

259-202702
Page J-105

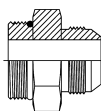

259-1290
Page J-106

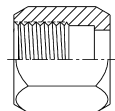

259-900605
Page J-106

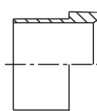

Ermeto

7165X
Page J-112



8165X
Page J-112



7105X
Page J-112

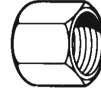

8112X
Page J-112

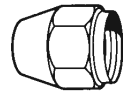

Ermeto (cont.)

7129X
Page J-113

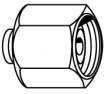

7229X
Page J-113

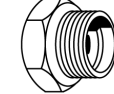

7015X
Page J-113

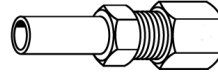

Ermeto (cont.)

7305X
Page J-114

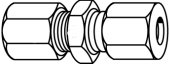

7306X
Page J-114

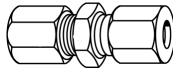

7325X
Page J-114

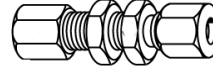

Ermeto (cont.)

7205X
Page J-115

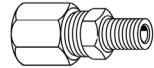

7255X
Page J-115

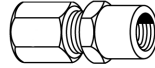

7315X
Page J-115

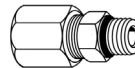

7355X
Page J-115

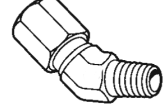

Ermeto (cont.)

7505X
Page J-116

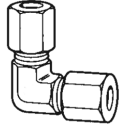

7405X
Page J-117

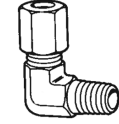

7455X
Page J-117

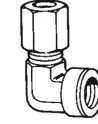

7515X
Page J-118

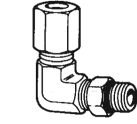

Ermeto (cont.)

7705X
Page J-118

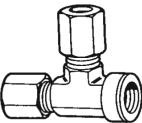

7755X
Page J-118

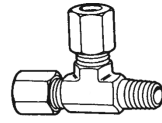

7805X
Page J-119

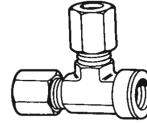

7716X
Page J-119

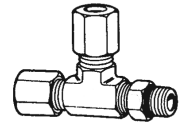

Ermeto (cont.)

7605X
Page J-120

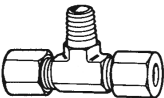

7655X
Page J-120

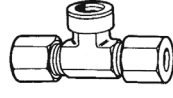

Adapters and tube fittings

Application data

J

The Eaton ORS™ connection is the universal answer to troublesome fluid leakage problems

ORS connection hose assembly

The ORS connection can be used with flexible hydraulic hose, combining the reusability of the hose fitting and the ORS connection. The result is the ultimate reusable fitting.

ORS connection hose assembly

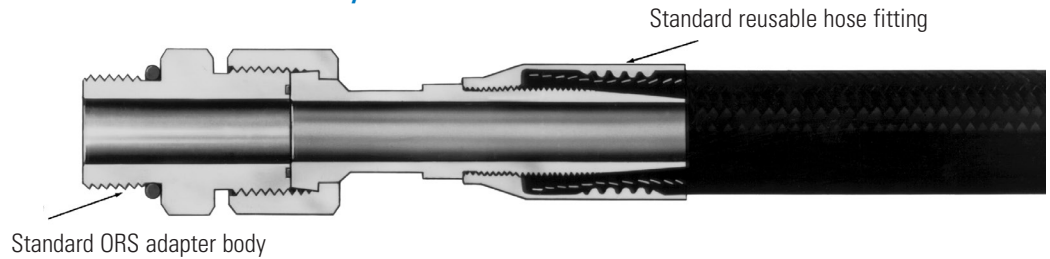

ORS Tube assemblies

The ORS connection can be attached to hydraulic tubing to make a tube assembly.

Two methods of attachment are available:

- **ORS-TF:** The ORS female can be joined directly to steel tubing with the ORS-TF (wedge-type) tube fitting, another Eaton innovation. The fitting becomes an integral part of your system at a fraction of the time and expense brazing requires. The versatility these options provides make ORS the only connection you need for high-pressure situations. It attaches to most types of fluid conveying lines, controlling most types of fluid, facing the toughest conditions.
- **ORS-braze type:** The ORS component can be brazed to hydraulic tubing

ORS-TF tube assembly

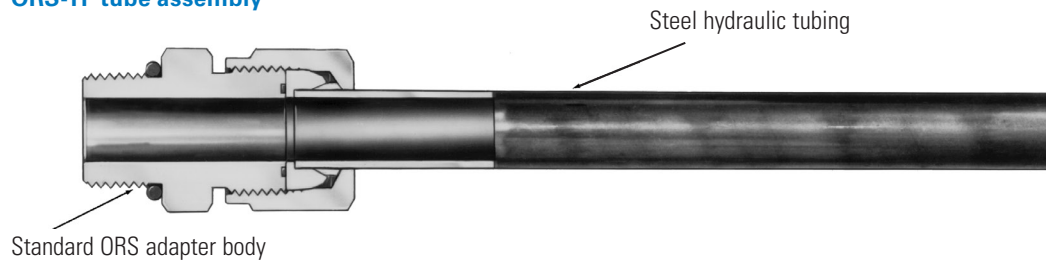

ORS-Braze type tube assembly

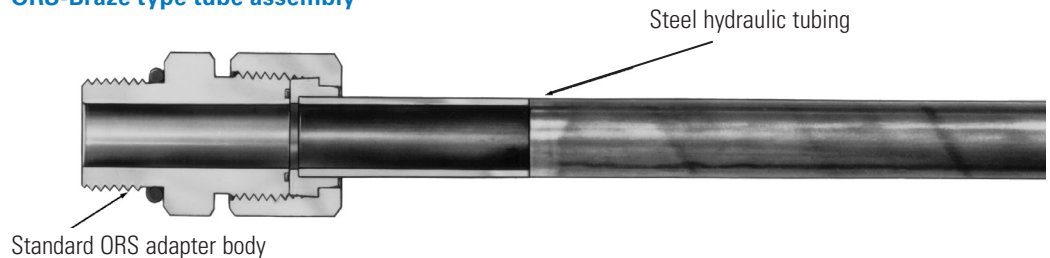

Versil-Flare™ flareless and Versil-Flare SAE 37° flared type

Both styles use the same SAE 37° flared body

Before connection

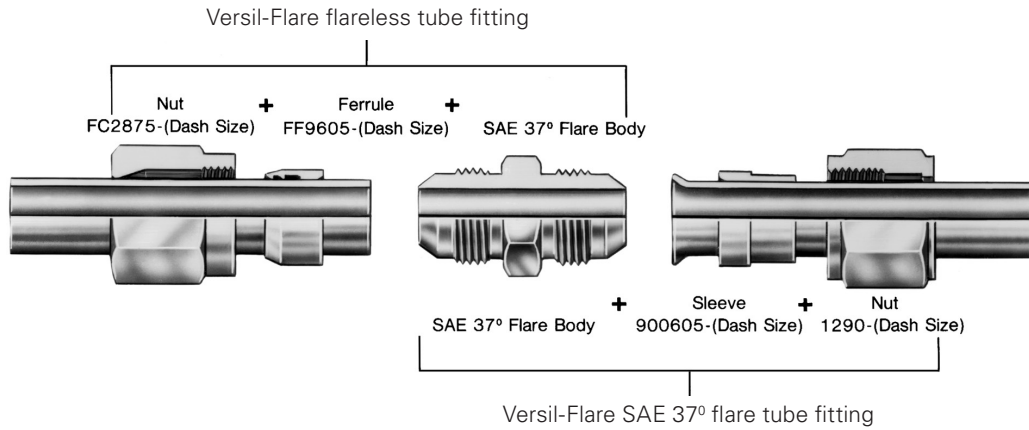

After connection

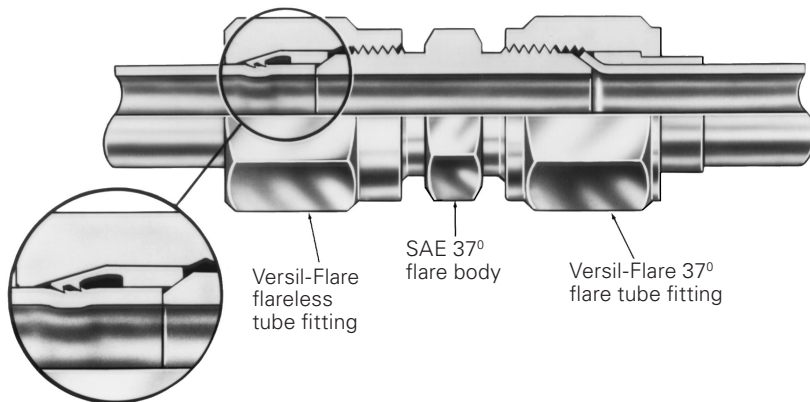

One inventory of bodies (any standard SAE 37° flare fitting) allows both flareless and flared type connection of standard steel hydraulic tubing. It is no longer necessary to inventory flared tube fittings plus the special bodies, nuts and sleeves for flareless tube fittings. The Eaton total tube fitting concept reduces inventory expense.

Adapters and tube fittings

Application data

J

Eaton Versil-Flare™ flareless tube fitting

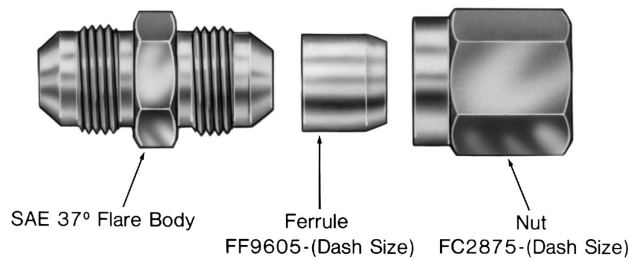

The Eaton Versil-Flare flareless tube fitting can use any standard SAE 37° male flare adapter or hose fitting as a body. This eliminates the need to inventory special flareless tube fitting bodies and results in reduced inventory expense. Eaton Versil-Flare flareless tube fittings are available in size from 3/16" tube O.D. to 2" tube O.D.

Presetting tools and extra assembly time are eliminated because there's no need for flaring, special preparation or presetting with the Eaton Versil-Flare flareless tube fitting. The chance of assembly error is reduced because the ferrule can be installed only one way and assembly is the same for all sizes and tube wall thicknesses. This assures a tight joint every time. These features improve production rates.

Eaton Versil-Flare™ flared tube fitting

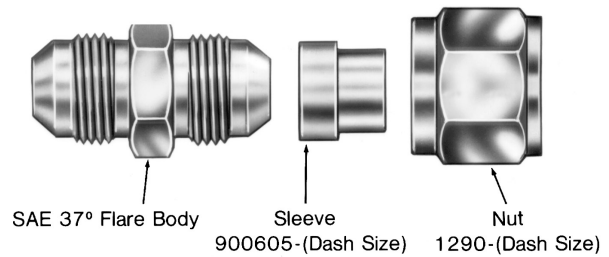

The Eaton industrial standard three piece Versil-Flare flared type tube fitting can be used on the full range of standard steel hydraulic tubing in various wall thicknesses from 3/16" tube O.D. to 2" tube O.D. All three components are constructed from high quality zinc plated steel for long service life.

The standard SAE 37° flare angle is used to produce a highly efficient seal under hydraulic pressures. The sleeve is used to help support the tube and absorb vibration.

Assembly is easy. A properly sized wrench and flaring tool are all that is necessary. This is important in tight locations. Eaton standard SAE 37° flare type fittings can also be dis-assembled and reassembled repeatedly.

Eaton quality is built into every component to assure leakproof connections. The Eaton standard SAE 37° flare type tube fitting conforms to the following hydraulic tube fitting standards. Society of Automotive Engineers, SAE J514.

Selection and sizing for both Versil-Flare flareless and Versil-Flare flared tube fittings

Tubing selection and sizing

Both Eaton Versil-Flare flareless and flared tube fittings can be used with SAE J-525 electric resistance welded, cold worked annealed, SAE J-524 seamless annealed tubing and SAE J527 brazed double wall low carbon steel tubing. SAE J356 welded flash controlled normalized steel tubing can only be used with Eaton Versil-Flare flareless tube fittings. **The maximum hardness of the above tubing should not exceed Rockwell B65.** Selection of proper tubing material, size and wall thickness depends on corrosion conditions, pressure and flow requirements and other operating requirements of the system.

How to order adapters

Adapter part numbers

Adapter part numbers consist of a base number followed by a size designation. If the part number contains a "T" character between the base number and size designator, the first size designator signifies the tube size.

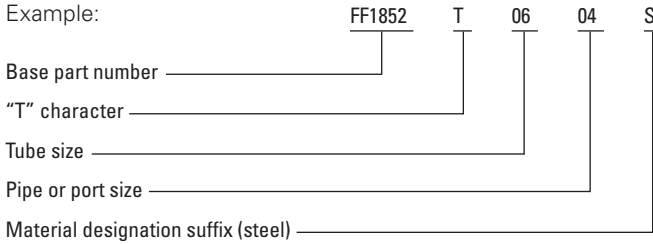

If the part number does not contain a "T" character between the base number and the size description, the first size designation signifies the port size.

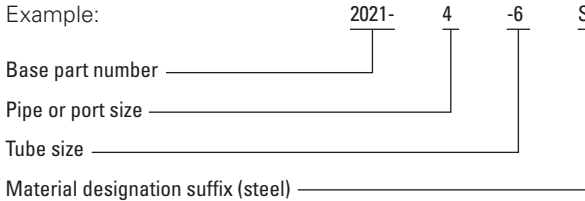

How to order adapters

Adapters are ordered using the complete part number as shown on the adapter pages.

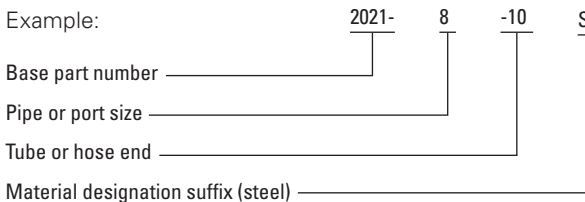

ORS adapters conversion*

ORS adapters come standard with the half dovetail groove design. The half dovetail groove is manufactured with an angle on the OD wall. This angle captures the O-Ring for maximum retention. For ease of installation, a half dovetail groove installation tool may be used.

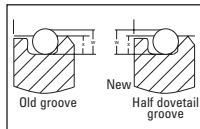

*Eaton reserves the right to use straight groove on some ORS.

Half dovetail groove installation tool

The half dovetail groove installation tool compresses the O-Ring, allowing it to easily slide into the groove in the adapter. Use of the tool maximizes efficiency and minimizes any fatigue that may be associated with repeated insertions over an extended period of time. One tool is required per dash size (or by adapter size). Each tool comes with an illustrated instruction sheet. Tools are available by using the following part numbers: FT1405-04, FT1405-06, FT1405-08, FT1405-10, FT1405-12, FT1405-16, FT1405-20, FT1405-24.



How to order ORS adapters and tube fittings

ORS tube fitting body with O-Ring, locknut and washer, where applicable.

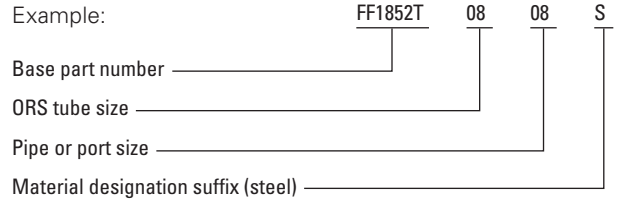

ORS tube fitting body without O-Ring

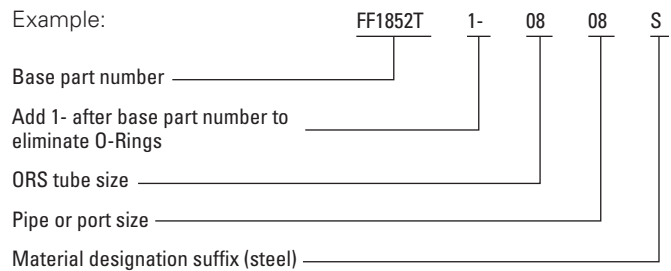

ORS bulkhead tube fitting body without bulkhead nut or O-Ring

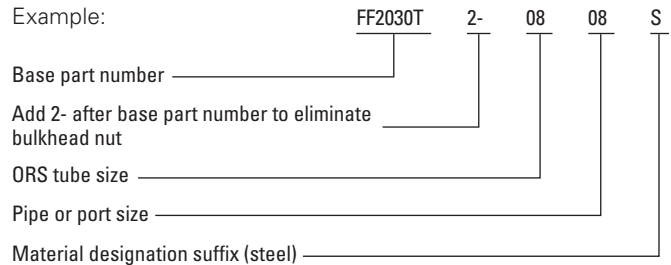

ORS-TF tube fitting components

ORS-TF tube fittings, nut, ferrules, and sleeves can be ordered under the following kit part number:

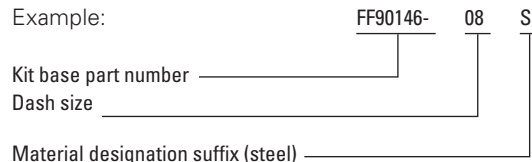

By ordering a single part number in kit form, you will receive the components ready to be assembled to an ORS tube fitting body:

- Example: FF90146-08S includes:
- FC1851-08S (ORS-TF Nut)
 - FF90102-08S (ORS-TF Ferrule)
 - FF90103-08S (ORS-TF Sleeve)

Adapters and tube fittings

Part structure

How to order ORS adapters and tube fittings

(continued)

Nuts and shoulders (Braze type)

Nuts and shoulders can be ordered separately. Simply use the base number, dash size, and material designation.

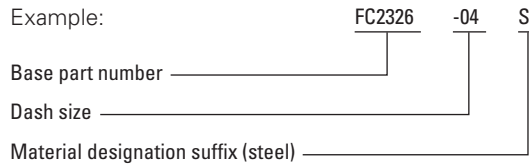

O-Rings

Buna-N O-Rings are standard. Other materials may also be specified by adding a material designator prefix if the part number begins with a numeric, and a material designator suffix if the part number begins with an alpha character. In all cases, the suffix "S" shall be omitted.

Material designation prefix/suffix	Material	Operating temperature range
S	90 Durometer Buna-N-Nitrile Rubber	-40°F to +250°F (-40°C to +121°C)
212	80 Durometer EPDM Ethylene propylene diene monomer	-65°F to +300°F (-55°C to +150°C)
213	90 Durometer Viton Fluoroelastomer	-15°F to +400°F (-26°C to +204°C)
214	90 Durometer Buna-N-Low Temperature Nitrile	-65°F to +225°F (-55°C to +100°C)
352	70 Durometer Neoprene	-65°F to +300°F (-55°C to +150°C)

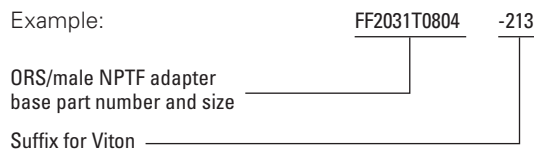

O-Rings can be ordered separately

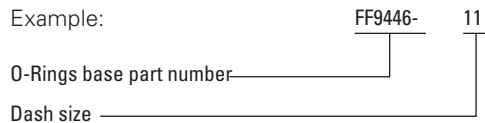

*See ORS O-Ring chart on page J-126

Body material

Steel is standard. Other materials may also be specified by adding a material designator prefix if the part number begins with a numeric, and a material designator suffix if the part number begins with an alpha character. In all cases, the suffix "S" shall be omitted.

Material designation prefix/suffix	Material
B (suffix only)	Brass
259	316-Stainless
4	Monel
S	Steel

How to order Conversion adapters BSPP/BSPT

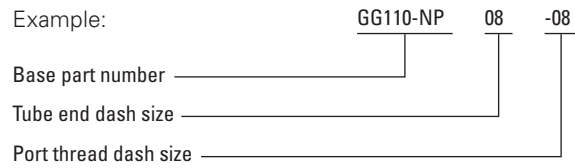

Metric

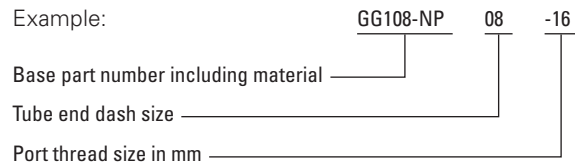

Dimensions

Eaton tube fittings are ordinarily designed and produced to the functional requirements set forth in SAE Standards J512, J513, J514, J1926 and J1453. However, in some cases the envelope dimensions of certain components vary slightly from cataloged or SAE referenced dimensions. The SAE reference numbers and fitting descriptions given are in accordance with SAE Standard J846.

Availability

All items listed in the current price schedule are normally carried in stock. Price and delivery of non-stocked and special parts may be obtained from your Eaton Sales Representative or Distributor.

Loctite™ Vibra-Seal 516 for external pipe threads

Loctite Vibra-Seal has the following characteristics:

- Non-hardening thread sealant
- Resists shredding and peeling during assembly
- Can be reused up to 5 times without recoating
- Provides resistance to vibrational loosening
- Excellent resistance to solvents and oils
- Operating temperatures range -65°F to +250°F

Machine applied so that it leaves first 1/2 to 2 threads uncovered for ease of assembly. Because of the excellent characteristics of this product, we are offering Loctite Vibra-Seal on all of our parts that have male pipe threads. Factory applied Loctite for external pipe threads may be ordered for steel parts by adding the prefix "307-" to the completed part number, and dropping suffix "S" if the part number begins with a numeral. Example: 307-2021-8-8.

If the part number begins with an alpha character, add the suffix "-307" to the completed part number and drop the suffix "S". Example: FF2031T0606-307.

™ Loctite is a trademark of Henkel Corporation.

ORS-TF tube fittings

The ORS-TF tube fitting utilizing the ORS-TF nut, ferrule and sleeve can be joined directly to steel tubing to solve your fluid leakage problems. It does not require the time and expense of brazing and provides the advantage of repetitive reuse. It is a compression type fitting that works on a variety of tubing.

Keep it simple and clean with ORS

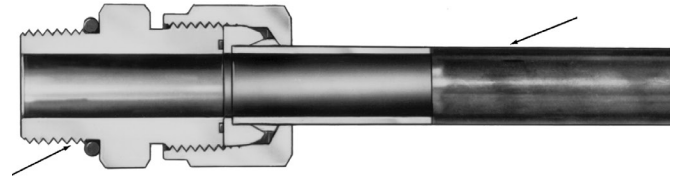

ORS-TF kit Part no. FF90146-(Size)

Includes:

- FC1851 ORS-TF Nut
- FF90102 ORS-TF Ferrule
- FF90103 ORS-TF Sleeve

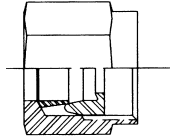

ORS-TF Nut

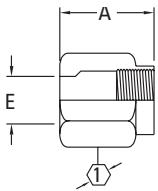

Part no. FC1851-(Dash size)

Dash size	Tube O. D.		Thread T1	A		E		①	
	mm	in		mm	in	mm	in	mm	in
04S	6,3	0.25	9/16-18	21,3	0.84	6,6	0.26	17,5	0.69
06S	9,6	0.38	11/16-16	23,6	0.93	9,6	0.38	20,6	0.81
08S	12,7	0.50	13/16-16	26,9	1.06	12,9	0.51	23,9	0.94
10S	16,0	0.63	1-14	28,7	1.13	16,0	0.63	28,4	1.12
12S	19,0	0.75	1 3/16-12	32,5	1.28	19,3	0.76	35,0	1.38
16S	25,4	1.00	1 7/16-12	34,3	1.35	25,6	1.01	41,1	1.62
20S	31,7	1.25	1 11/16-12	35,8	1.41	32,0	1.26	47,7	1.88
24S	38,1	1.50	2-12	37,3	1.47	38,3	1.51	57,1	2.25

ORS-TF Ferrule

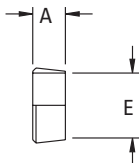

Part no. FF90102-(Dash size)

Dash size	Tube O. D.		A		E	
	mm	in	mm	in	mm	in
FF90102-04S	6,3	0.25	6,3	0.25	6,6	0.26
FF90102-06S	9,6	0.38	6,3	0.25	9,6	0.38
FF90102-08S	12,7	0.50	7,6	1.50	12,9	0.51
FF90102-10S	16,0	0.63	7,6	1.50	16,0	0.63
FF90102-12S	19,0	0.75	7,6	1.50	19,3	0.76
FF90102-16S	25,4	1.00	7,6	1.50	25,6	1.01
FF90102-20S	31,7	1.25	7,6	1.50	32,0	1.26
FF90102-24S	38,1	1.50	7,6	1.50	38,3	1.51

ORS-TF Sleeve

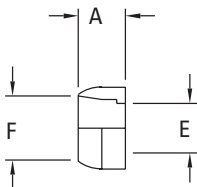

Part no. FF90103-(Dash size)

Dash size	Tube O. D.		A		E		F	
	mm	in	mm	in	mm	in	mm	in
FF90103-04S	6,3	0.25	8,1	0.32	4,3	0.17	6,3	0.25
FF90103-06S	9,6	0.38	8,6	0.34	6,6	0.26	9,6	0.38
FF90103-08S	12,7	0.50	9,4	0.37	9,6	0.38	12,7	0.50
FF90103-10S	16,0	0.63	10,2	0.40	12,2	0.48	16,0	0.63
FF90103-12S	19,0	0.75	11,2	0.44	15,5	0.61	19,3	0.76
FF90103-16S	25,4	1.00	12,7	0.50	20,6	0.81	25,4	1.00
FF90103-20S	31,7	1.25	14,2	0.56	26,7	1.05	32,0	1.26
FF90103-24S	38,1	1.50	15,7	0.62	32,0	1.26	38,3	1.51

Material: Corrosion-resistant plated steel.

Adapters and tube fittings

ORS braze type

J

ORS braze type

ORS-BR shoulder internal braze

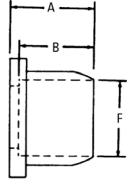

CAUTION

In applications exceeding +480°F (such as during brazing) order the oil-coated/ non-plated nut by using part number FC1857- Size-186. When plating is heated above +480°F, toxic gases are given off.

Part no. FC1229-(Dash size)* (Ref. SAE 520115)

Dash size	Tube O. D.		A		B		F	
	mm	in	mm	in	mm	in	mm	in
0404S	6,4	0.25	7,4	0.29	6,4	0.25	6,4	0.25
0604S	9,7	0.38	8,4	0.33	6,4	0.25	6,4	0.25
0606S	9,7	0.38	7,4	0.29	6,4	0.25	9,7	0.38
0806S	12,7	0.50	9,9	0.39	6,4	0.25	9,7	0.38
0808S	12,7	0.50	10,7	0.42	9,7	0.38	12,7	0.50
1208S	12,7	0.50	15,5	0.61	9,7	0.38	12,7	0.50
1010S	16,0	0.63	10,7	0.42	9,7	0.38	15,7	0.62
1210S	19,0	0.75	15,5	0.61	9,7	0.38	15,7	0.62
1212S	19,0	0.75	11,2	0.44	9,7	0.38	19,0	0.75
1612S	25,4	1.00	14,0	0.55	9,7	0.38	19,0	0.75
1614S	25,4	1.00	14,2	0.56	11,2	0.44	22,3	0.88
1616S	25,4	1.00	14,2	0.56	12,7	0.50	25,4	1.00
2016S	31,8	1.25	17,3	0.68	12,7	0.50	25,4	1.00
2020S	31,8	1.25	14,2	0.56	12,7	0.50	31,8	1.25
2420S	38,1	1.50	18,8	0.74	12,7	0.50	31,8	1.25
2424S	38,1	1.50	14,2	0.56	12,7	0.50	38,1	1.50

ORS-BR shoulder external braze/weld

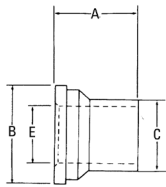

CAUTION

In applications exceeding +480°F (such as during brazing) order the oil-coated/ non-plated nut by using part number FC1857- Size-186. When plating is heated above +480°F, toxic gases are given off.

Part no. FC2325-(Dash size)* (Ref. SAE 520172)

Dash size	Tube O. D.		A		B		C		E	
	mm	in	mm	in	mm	in	mm	in	mm	in
0404S	6,4	0.25	22,3	0.88	12,7	0.50	6,4	0.25	4,3	0.17
0606S	9,7	0.38	24,4	0.96	15,7	0.62	9,7	0.38	6,6	0.26
0808S	12,7	0.50	31,8	1.25	18,8	0.74	12,7	0.50	9,1	0.36
1010S	16,0	0.63	34,0	1.34	23,4	0.92	15,7	0.62	11,4	0.45
1212S	19,0	0.75	36,6	1.44	27,7	1.09	19,0	0.75	14,0	0.55
1616S	25,4	1.00	41,4	1.63	34,0	1.34	25,4	1.00	19,8	0.78
2020S	31,8	1.25	41,4	1.63	40,4	1.59	31,8	1.25	26,7	1.05
2424S	38,1	1.50	41,4	1.63	48,5	1.91	38,1	1.50	32,0	1.26

*Eaton braze counterbores are dimensioned for sized or emeryed tubing. If tubing is used as received, contact Eaton for appropriate part number.

ORS braze type

ORS bulkhead male/braze adapter

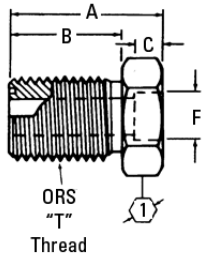

Part no. FF1922T-(Dash size)* (Ref. SAE 520604)

Dash size	Tube O. D.		Thread T1	A		B		C		D		①
	mm	in		mm	in	mm	in	mm	in	mm	in	
0404S	6,4	0.25	9/16-18	40,9	1.61	31,5	1.24	6,4	0.25	6,4	0.25	0.81
0606S	9,7	0.38	11/16-16	43,7	1.72	34,0	1.34	6,4	0.25	9,7	0.38	1.00
0808S	12,7	0.50	13/16-16	49,3	1.94	36,6	1.44	9,7	0.38	12,7	0.50	1.12
1010S	16,0	0.63	1-14	53,6	2.11	40,6	1.60	9,7	0.38	15,7	0.62	1.31
1212S	19,0	0.75	1 3/16-12	55,4	2.18	41,6	1.64	9,7	0.38	19,0	0.75	1.50
1616S	25,4	1.00	1 7/16-12	61,7	2.43	42,2	1.66	12,7	0.50	25,4	1.00	1.75

ORS/braze adapter

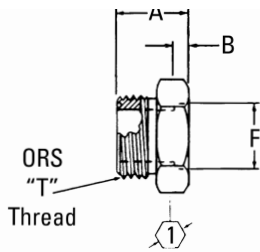

Part no. FF1851T-(Dash size)* (Ref. SAE 520104)

Dash size	Tube O. D.		Thread T1	A		B		F		①
	mm	in		mm	in	mm	in	mm	in	
0404S	6,4	0.25	9/16-18	19,8	0.78	6,4	0.25	6,4	0.25	0.62
0604S	9,7	0.38	11/16-16	21,0	0.83	6,4	0.25	6,4	0.25	0.75
0606S	9,7	0.38	11/16-16	21,0	0.83	6,4	0.25	9,7	0.38	0.75
0608S	9,7	0.38	11/16-16	24,1	0.95	9,7	0.38	12,7	0.50	0.75
0806S	12,7	0.50	13/16-16	22,3	0.88	6,4	0.25	9,7	3.38	0.88
1008S	16,0	0.63	1-14	28,5	1.12	9,7	0.38	12,7	0.50	1.06
1010S	16,0	0.63	1-14	28,5	1.12	9,7	0.38	15,7	0.62	1.06
1210S	19,0	0.75	1 3/16-12	29,7	1.17	9,7	0.38	15,7	0.62	1.25
1212S	19,0	0.75	1 3/16-12	30,7	1.21	9,7	0.38	19,0	0.75	1.25
1216S	19,0	0.75	1 3/16-12	36,8	1.45	12,7	0.50	25,4	1.00	1.50
1612S	25,4	1.00	1 7/16-12	30,7	1.21	9,7	0.38	19,0	0.75	1.50
1616S	25,4	1.00	1 7/16-12	37,3	1.47	12,7	0.50	25,4	1.00	1.50
1620S	25,4	1.00	1 7/16-12	37,3	1.47	12,7	0.50	31,8	1.25	1.75
2016S	31,8	1.25	1 11/16-12	37,3	1.47	12,7	0.50	25,4	1.00	1.75
2020S	31,8	1.25	1 11/16-12	37,3	1.47	12,7	0.50	31,8	1.25	1.75
2024S	31,8	1.25	1 11/16-12	37,3	1.47	12,7	0.50	38,1	1.50	2.12
2424S	38,1	1.50	2-12	37,3	1.47	12,7	0.50	38,1	1.50	2.12

*Eaton braze counterbores are dimensioned for sized or emeryed tubing. If tubing is used as received, contact Eaton for appropriate part number.

Adapters and tube fittings

ORS braze type

J

ORS braze type

90° ORS/braze port adapter

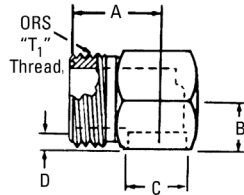

Part no. FF1856T-(Dash size)* (Ref. SAE 520204)

Dash size	Tube O. D.		Thread T1	A		B		C		D	
	mm	in		mm	in	mm	in	mm	in	mm	in
0606S	9,7	0.38	11/16-16	24,9	0.98	10,4	0.41	9,7	0.38	6,4	0.25
0808S	12,7	0.50	13/16-16	27,9	1.10	15,0	0.59	12,7	0.50	9,7	0.38
1010S	16,0	0.63	1-14	33,3	1.31	16,8	0.66	15,7	0.62	9,7	0.38
1212S	19,0	0.75	1 3/16-12	37,3	1.47	18,3	0.72	19,0	0.75	9,7	0.38
1616S	25,4	1.00	1 7/16-12	41,6	1.64	23,9	0.94	25,4	1.00	13,2	0.52
1820S	25,4	1.00	1 7/16-12	44,7	1.76	28,5	1.12	31,8	1.25	13,5	0.53
2424S	38,1	1.50	2-12	48,8	1.92	31,8	1.25	38,1	1.50	13,2	0.52

ORS/ORS/braze port adapter

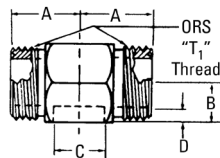

Part no. FF1858T-(Dash size)* (Ref. SAE 520472)

Dash size	Tube O. D.		Thread T1	A		B		C		D	
	mm	in		mm	in	mm	in	mm	in	mm	in
0606S	9,7	0.38	11/16-16	24,9	0.98	9,9	0.39	9,7	0.38	6,4	0.25
1616S	25,4	1.00	1 7/16-12	41,6	1.64	23,1	0.91	25,4	1.00	13,2	0.52

ORS/braze/ORS port adapter

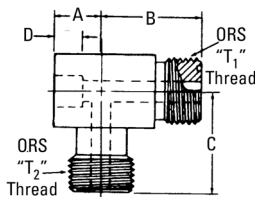

Part no. FF2115T-(Dash size)* (Ref. SAE 520472)

Dash size	Tube O. D.		Thread T1	Thread T2	A		B		C		D	
	mm	in			mm	in	mm	in	mm	in	mm	in
0606S	9,7	0.38	11/16-16	11/16-16	10,4	0.41	24,9	0.98	24,9	0.98	6,4	0.25

*Eaton braze counterbores are dimensioned for sized or emeryed tubing. If tubing is used as received, contact Eaton for appropriate part number.

ORS-BR nut

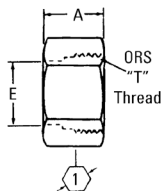

Part no. FC2326-(Dash size) (Ref. SAE 520110)

Dash size	Tube O. D.		Thread T1	A		E		①	
	mm	in		mm	in	mm	in		
04S	6,4	0.25	9/16-18	14,7	0.58	10,4	0.41	17,5	0.69
06S	9,7	0.38	11/16-16	17,0	0.67	13,5	0.53	20,6	0.81
08S	12,7	0.50	13/16-16	21,0	0.83	16,5	0.65	23,9	0.94
10S	16,0	0.63	1-14	23,4	0.92	21,0	0.83	28,5	1.12
12S	19,0	0.75	1 3/16-12	25,9	1.02	24,1	0.95	35,1	1.38
1214S	22,3	0.88	1 3/16-12	31,0	1.22	25,1	0.99	35,1	1.38
16S	25,4	1.00	1 7/16-12	27,9	1.10	29,0	1.14	41,1	1.62
20S	31,8	1.25	1 11/16-12	27,9	1.10	36,1	1.42	47,7	1.88
24S	38,1	1.50	2-12	27,9	1.10	43,9	1.73	57,2	2.25

CAUTION

In applications exceeding +480°F (such as during brazing) order the oil-coated/ non-plated nut by using part number FC1857- Size-186. When plating is heated above +480°F, toxic gases are given off.

ORS/SAE O-Ring boss

ORS/SAE O-Ring boss adapter

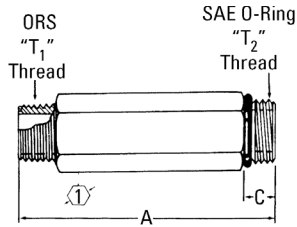

Part no. FF2211T-(Dash size) (Ref. SAE 520122)

Dash size	Tube O. D.		Thread T1	Thread T2	A		C		①	
	mm	in			mm	in	mm	in	mm	in
0606S	9,7	0.38	11/16-16	9/16-18	50,0	1.97	11,9	0.47	19,0	0.75
0608S	9,7	0.38	11/16-16	3/4-16	54,1	2.13	14,0	0.55	22,3	0.88
0808S	12,7	0.50	13/16-16	3/4-16	68,1	2.68	14,0	0.55	22,3	0.88
1212S	19,0	0.75	1 3/16-12	1 1/16-12	72,9	2.87	18,5	0.73	31,8	1.25
1616S	25,4	1.00	1 7/16-12	1 5/16-12	104,5	4.11	18,5	0.73	38,1	1.50

ORS/SAE O-Ring boss long adapter

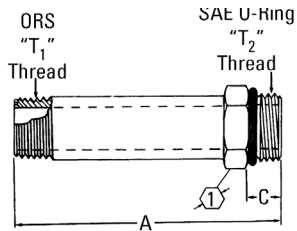

Part no. FF1854T-(Dash size) (Ref. SAE 520122)

Dash size	Tube O. D.		Thread T1	Thread T2	A		C		①	
	mm	in			mm	in	mm	in	mm	in
0404S	6,4	0.25	9/16-18	7/16-20	52,6	2.07	10,9	0.43	15,7	0.62
0606S	9,7	0.38	11/16-16	9/16-18	57,6	2.27	11,9	0.47	19,0	0.75
0808S	12,7	0.50	13/16-16	3/4-16	67,8	2.67	14,0	0.55	22,3	0.88
1010S	16,0	0.63	1-14	7/8-14	79,5	3.13	16,0	0.63	26,9	1.06
1212S	19,0	0.75	1 3/16-12	1 1/16-12	95,2	3.75	18,5	0.73	31,8	1.25
1616S	25,4	1.00	1 7/16-12	1 5/16-12	104,9	4.13	18,5	0.73	38,1	1.50
2020S	31,8	1.25	1 11/16-12	1 5/8-12	120,6	4.75	18,5	0.73	47,7	1.88
2424S	38,1	1.50	2-12	1 7/8-12	133,6	5.26	18,5	0.73	53,9	2.12

ORS female swivel/SAE O-Ring boss adapter

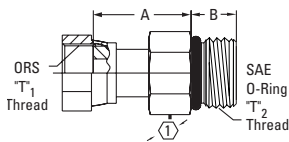

Part no. FF2130T-(Dash size) (Ref. SAE 520181)

Dash size	Tube O. D.		Thread T1	Thread T2	A		B		①	
	mm	in			mm	in	mm	in	mm	in
0606S	9,7	0.38	11/16-16	9/16-18	28,2	1.11	11,9	0.47	17,5	0.69
0808S	12,7	0.50	13/16-16	3/4-16	35,3	1.39	14,0	0.55	22,3	0.88
1212S	19,0	0.75	1 3/16-12	1 1/16-12	41,1	1.62	18,5	0.73	31,8	1.25
1616S	25,4	1.00	1 7/16-12	1 5/16-12	49,0	1.93	18,5	0.73	38,1	1.50
2020S	31,8	1.25	1 11/16-12	1 5/8-12	47,2	1.86	18,5	0.73	47,7	1.88

Adapters and tube fittings

ORS/SAE O-Ring boss

J

ORS/SAE O-Ring boss

ORS/SAE O-Ring boss adapter

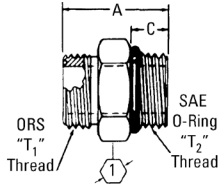

Part no. FF1852T-(Dash size) (Ref. SAE 520120)

Dash size	Tube O. D.		Thread T1	Thread T2	A		C		①
	mm	in			mm	in	mm	in	
0403S	6,4	0.25	9/16-18	3/8-24	27,2	1.07	9,4	0.37	15,7 0.62
0404S	6,4	0.25	9/16-18	7/16-20	28,7	1.13	10,9	0.43	15,7 0.62
0405S	6,4	0.25	9/16-18	1/2-20	28,7	1.13	10,9	0.43	15,7 0.62
0406S	6,4	0.25	9/16-18	9/16-18	30,5	1.20	11,9	0.47	17,5 0.69
0408S	6,4	0.25	9/16-18	3/4-16	33,6	1.32	14,0	0.55	22,4 0.88
0603S	9,7	0.38	11/16-16	3/8-24	32,5	1.28	9,4	0.37	19,1 0.75
0604S	9,7	0.38	11/16-16	7/16-20	34,0	1.34	10,9	0.43	19,1 0.75
0605S	9,7	0.38	11/16-16	1/2-20	31,0	1.22	10,9	0.43	19,1 0.75
0606S	9,7	0.38	11/16-16	9/16-18	32,0	1.26	11,9	0.47	19,1 0.75
0608S	9,7	0.38	11/16-16	3/4-16	35,1	1.38	14,0	0.55	22,4 0.88
0610S	9,7	0.38	11/16-16	7/8-14	38,9	1.53	16,0	0.63	25,4 1.00
0612S	9,7	0.38	11/16-16	1 1/16-12	42,9	1.69	18,5	0.73	31,8 1.25
0616S	9,7	0.38	11/16-16	1 5/16-12	43,9	1.73	18,5	0.73	38,1 1.50
0806S	12,7	0.50	13/16-16	9/16-18	37,6	1.48	11,9	0.47	22,4 0.88
0808S	12,7	0.50	13/16-16	3/4-16	36,6	1.44	14,0	0.55	22,4 0.88
0810S	12,7	0.50	13/16-16	7/8-14	40,4	1.59	16,0	0.63	25,4 1.00
0812S	12,7	0.50	13/16-16	1 1/16-12	44,5	1.75	18,5	0.73	31,8 1.25
0814S	12,7	0.50	13/16-16	1 3/16-12	44,5	1.75	18,5	0.73	35,1 1.38
0816S	12,7	0.50	13/16-16	1 5/16-12	45,5	1.79	18,5	0.73	38,1 1.50
1008S	16,0	0.63	1-14	3/4-16	45,2	1.78	14,0	0.55	26,9 1.06
1010S	16,0	0.63	1-14	7/8-14	43,2	1.70	16,0	0.63	26,9 1.06
1012S	16,0	0.63	1-14	1 1/16-12	47,2	1.86	18,5	0.73	31,8 1.25
1016S	16,0	0.63	1-14	1 5/16-12	48,3	1.90	18,5	0.73	38,1 1.50
1206S	19,0	0.75	1 3/16-12	9/16-18	45,0	1.77	11,9	0.47	31,8 1.25
1208S	19,0	0.75	1 3/16-12	3/4-16	48,5	1.91	14,0	0.55	31,8 1.25
1210S	19,0	0.75	1 3/16-12	7/8-14	50,5	1.99	16,0	0.63	31,8 1.25
1212S	19,0	0.75	1 3/16-12	1 1/16-12	48,8	1.92	18,5	0.73	31,8 1.25
1214S	19,0	0.75	1 3/16-12	1 3/16-12	48,8	1.92	18,5	0.73	35,1 1.38
1216S	19,0	0.75	1 3/16-12	1 5/16-12	49,8	1.96	18,5	0.73	38,1 1.50
1608S	25,4	1.00	1 7/16-12	3/4-16	49,8	1.96	14,0	0.55	38,1 1.50
1610S	25,4	1.00	1 7/16-12	7/8-14	51,8	2.04	16,0	0.63	38,1 1.50
1612S	25,4	1.00	1 7/16-12	1 1/16-12	54,4	2.14	18,5	0.73	38,1 1.50
1614S	25,4	1.00	1 7/16-12	1 3/16-12	50,3	1.98	18,5	0.73	38,1 1.50
1616S	25,4	1.00	1 7/16-12	1 5/16-12	50,3	1.98	18,5	0.73	38,1 1.50
1620S	25,4	1.00	1 7/16-12	1 5/8-12	52,3	2.06	18,5	0.73	47,8 1.88
2016S	31,8	1.25	1 11/16-12	1 5/16-12	57,9	2.28	18,5	0.73	44,5 1.75
2020S	31,8	1.25	1 11/16-12	1 5/8-12	52,3	2.06	18,5	0.73	47,8 1.88
2024S	31,8	1.25	1 11/16-12	1 7/8-12	54,1	2.13	18,5	0.73	53,8 2.12
2420S	38,1	1.50	2-12	1 5/8-12	59,7	2.35	18,5	0.73	53,8 2.12
2424S	38,1	1.50	2-12	1 7/8-12	54,1	2.13	18,5	0.73	53,8 2.12

ORS/SAE O-Ring boss

90° ORS/SAE O-Ring boss (adj.) adapter

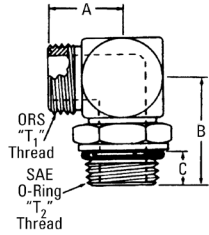

Part no. FF1868T-(Dash size) (Ref. SAE 520220)

Dash size	Tube O. D.		Thread T1	Thread T2	A		B		C	
	mm	in			mm	in	mm	in	mm	in
0403S	6,4	0.25	9/16-18	3/8-24	21,6	0.85	30,2	1.19	9,1	0.36
0404S	6,4	0.25	9/16-18	7/16-20	21,6	0.85	32,8	1.29	10,4	0.41
0405S	6,4	0.25	9/16-18	1/2-20	22,4	0.88	34,5	1.36	10,4	0.41
0406S	6,4	0.25	9/16-18	9/16-18	23,4	0.92	36,8	1.45	11,7	0.46
0408S	6,4	0.25	9/16-18	3/4-16	24,6	0.97	40,6	1.60	13,2	0.52
0603S	9,7	0.38	11/16-16	3/8-24	24,9	0.98	32,0	1.26	9,1	0.36
0604S	9,7	0.38	11/16-16	7/16-20	24,9	0.98	34,8	1.37	10,4	0.41
0605S	9,7	0.38	11/16-16	1/2-20	24,9	0.98	34,8	1.37	10,4	0.41
0606S	9,7	0.38	11/16-16	9/16-18	24,9	0.98	36,8	1.45	11,7	0.46
0608S	9,7	0.38	11/16-16	3/4-16	26,4	1.04	40,6	1.60	13,2	0.52
0610S	9,7	0.38	11/16-16	7/8-14	29,2	1.15	50,0	1.97	15,7	0.62
0612S	9,7	0.38	11/16-16	1 1/16-12	31,8	1.25	55,1	2.17	18,0	0.71
0806S	12,7	0.50	13/16-16	9/16-18	28,2	1.11	36,6	1.44	11,7	0.46
0808S	12,7	0.50	13/16-16	3/4-16	27,9	1.10	40,6	1.60	13,2	0.52
0810S	12,7	0.50	13/16-16	7/8-14	30,7	1.21	50,0	1.97	15,7	0.62
0812S	12,7	0.50	13/16-16	1 1/16-12	33,5	1.32	55,1	2.17	18,0	0.71
1008S	16,0	0.63	1-14	3/4-16	33,3	1.31	45,7	1.80	13,2	0.52
1010S	16,0	0.63	1-14	7/8-14	33,3	1.31	50,0	1.97	15,7	0.62
1012S	16,0	0.63	1-14	1 1/16-12	35,8	1.41	55,1	2.17	18,0	0.71
1016S	16,0	0.63	1-14	1 5/16-12	39,6	1.56	59,7	2.35	18,0	0.71
1206S	19,0	0.75	1 3/16-12	9/16-18	37,3	1.47	42,7	1.68	11,7	0.46
1208S	19,0	0.75	1 3/16-12	3/4-16	37,3	1.47	46,7	1.84	13,2	0.52
1212S	19,0	0.75	1 3/16-12	1 1/16-12	37,3	1.47	55,1	2.17	18,0	0.71
1216S	19,0	0.75	1 3/16-12	1 5/16-12	41,1	1.62	59,7	2.35	18,0	0.71
1220S	19,0	0.75	1 3/16-12	1 5/8-12	44,2	1.74	62,2	2.45	18,0	0.71
1612S	25,4	1.00	1 7/16-12	1 1/16-12	41,7	1.64	58,9	2.32	18,0	0.71
1614S	25,4	1.00	1 7/16-12	1 3/16-12	41,7	1.64	58,9	2.32	18,0	0.71
1616S	25,4	1.00	1 7/16-12	1 5/16-12	41,7	1.64	59,7	2.35	18,0	0.71
1620S	25,4	1.00	1 7/16-12	1 5/8-12	44,7	1.76	62,2	2.45	18,0	0.71
2012S	31,8	1.25	1 11/16-12	1 1/16-12	44,7	1.76	61,5	2.42	18,0	0.71
2016S	31,8	1.25	1 11/16-12	1 5/16-12	44,7	1.76	61,5	2.42	18,0	0.71
2020S	31,8	1.25	1 11/16-12	1 5/8-12	44,7	1.76	62,2	2.45	18,0	0.71
2024S	31,8	1.25	1 11/16-12	1 7/8-12	48,8	1.92	65,8	2.59	18,0	0.71
2420S	38,1	1.50	2-12	1 5/8-12	48,8	1.92	65,8	2.59	18,0	0.71
2424S	38,1	1.50	2-12	1 7/8-12	48,8	1.92	65,8	2.59	18,0	0.71

90° ORS/SAE O-Ring boss (adj.) long adapter

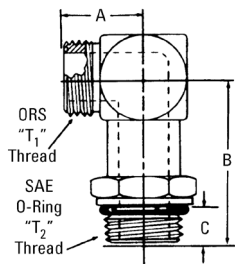

Part no. FF2227T-(Dash size) (Ref. SAE 521520)

Dash size	Tube O. D.		Thread T1	Thread T2	A		B		C	
	mm	in			mm	in	mm	in	mm	in
0404S	6,4	0.25	9/16-18	7/16-20	21,6	0.85	56,6	2.23	10,9	0.43
0606S	9,7	0.38	11/16-16	9/16-18	24,9	0.98	66,3	2.61	11,9	0.47
0808S	12,7	0.50	13/16-16	3/4-16	27,9	1.10	74,9	2.95	14,0	0.55
1010S	16,0	0.63	1-14	7/8-14	33,3	1.31	89,1	3.51	16,0	0.63
1212S	19,0	0.75	1 3/16-12	1 1/16-12	37,3	1.47	100,8	3.97	18,5	0.73
1616S	25,4	1.00	1 7/16-12	1 5/16-12	41,6	1.64	114,5	4.51	18,5	0.73
2020S	31,8	1.25	1 11/16-12	1 5/8-12	44,7	1.76	126,5	4.98	18,5	0.73

Adapters and tube fittings

ORS/SAE O-Ring boss

J

ORS/SAE O-Ring boss

45° ORS/SAE O-Ring boss (adj.) adapter

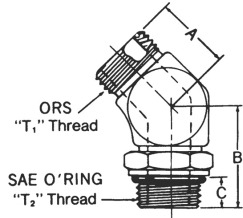

Part no. FF2068T-(Dash size) (Ref. SAE 520320)

Dash size	Tube O. D.		Thread T1	Thread T2	A		B		C	
	mm	in			mm	in	mm	in	mm	in
0403S	6,4	0.25	9/16-18	3/8-24	16,0	0.63	27,4	1.08	9,1	0.36
0404S	6,4	0.25	9/16-18	7/16-20	16,0	0.63	30,0	1.18	10,4	0.41
0406S	6,4	0.25	9/16-18	9/16-18	17,3	0.68	33,0	1.30	11,7	0.46
0408S	6,4	0.25	9/16-18	3/4-16	17,0	0.67	36,3	1.43	13,2	0.52
0604S	9,7	0.38	11/16-16	7/16-20	18,8	0.74	31,0	1.22	10,4	0.41
0606S	9,7	0.38	11/16-16	9/16-18	18,8	0.74	33,0	1.30	11,7	0.46
0608S	9,7	0.38	11/16-16	3/4-16	18,8	0.74	36,3	1.43	13,2	0.52
0806S	12,7	0.50	13/16-16	9/16-18	20,3	0.80	32,3	1.27	11,7	0.46
0808S	12,7	0.50	13/16-16	3/4-16	20,3	0.80	36,3	1.43	13,2	0.52
0810S	12,7	0.50	13/16-16	7/8-14	20,8	0.82	44,7	1.76	15,7	0.62
0816S	12,7	0.50	13/16-16	1 5/16-12	25,7	1.01	52,3	2.06	18,0	0.71
1008S	16,0	0.63	1-14	3/4-16	23,4	0.92	40,4	1.59	13,2	0.52
1010S	16,0	0.63	1-14	7/8-14	23,4	0.92	44,7	1.76	15,7	0.62
1012S	16,0	0.63	1-14	1 1/16-12	24,4	0.96	50,0	1.97	18,0	0.71
1208S	19,0	0.75	1 3/16-12	3/4-16	25,9	1.02	41,7	1.64	13,2	0.52
1210S	19,0	0.75	1 3/16-12	7/8-14	25,9	1.02	46,0	1.81	15,7	0.62
1212S	19,0	0.75	1 3/16-12	1 1/16-12	25,9	1.02	50,0	1.97	18,0	0.71
1216S	19,0	0.75	1 3/16-12	1 5/16-12	29,5	1.16	52,3	2.06	18,0	0.71
1612S	25,4	1.00	1 7/16-12	1 1/16-12	30,0	1.18	51,6	2.03	18,0	0.71
1616S	25,4	1.00	1 7/16-12	1 5/16-12	30,0	1.18	52,3	2.06	18,0	0.71
1620S	25,4	1.00	1 7/16-12	1 5/8-12	32,0	1.26	53,6	2.11	18,0	0.71
2020S	31,8	1.25	1 11/16-12	1 5/8-12	32,0	1.26	53,6	2.11	18,0	0.71
2424S	38,1	1.50	2-12	1 7/8-12	36,8	1.45	53,6	2.11	18,0	0.71

ORS/SAE O-Ring boss

ORS/ORS/SAE O-Ring boss (adj.) adapter

Part no. FF1861T-(Dash size) (Ref. SAE 520429)

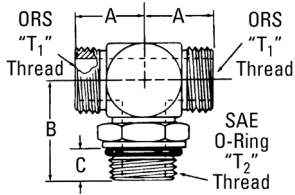

Dash size	Tube O. D.		Thread T1	Thread T2	A		B		C	
	mm	in			mm	in	mm	in		
0404S	6,4	0.25	9/16-18	7/16-20	21,6	0.85	32,8	1.29	10,9	0.43
0606S	9,7	0.38	11/16-16	9/16-18	24,9	0.98	36,8	1.45	11,9	0.47
0608S	9,7	0.38	11/16-16	3/4-16	26,4	1.04	40,6	1.60	14,0	0.55
0806S	12,7	0.50	13/16-16	9/16-16	27,9	1.10	50,0	1.97	14,0	0.55
0808S	16,0	0.63	1-14	3/4-16	36,6	1.44	50,0	1.97	16,0	0.63
1010S	19,0	0.75	1 3/16-12	7/8-14	37,3	1.47	55,2	2.17	16,0	0.63
1210S	19,0	0.75	1 3/16-12	7/8-14	41,1	1.62	59,7	2.35	18,5	0.73
1212S	19,0	0.75	1 3/16-12	1 5/16-12	41,6	1.64	59,7	2.35	18,5	0.73
1216S	25,4	1.00	1 7/16-12	1 5/16-12	41,6	1.64	59,7	2.35	18,5	0.73
1616S	25,4	1.00	1 7/16-12	1 5/16-12	41,7	1.64	59,7	2.35	18,0	0.71
2020S	31,8	1.25	1 11/16-12	1 5/8-12	44,7	1.76	62,2	2.45	18,5	0.73
2424S	38,1	1.50	2-12	1 7/8-12	48,8	1.92	65,8	2.59	18,5	0.73

ORS/ORS/SAE O-Ring boss (adj.) adapter

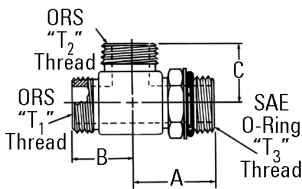

Part no. FF1865T-(Dash size) (Ref. SAE 520428)

Dash size	Tube O. D.		Thread T1	Thread T2	Thread T3	A		B		C	
	mm	in				mm	in	mm	in		
0404S	6,4	0.25	9/16-18	9/16-18	7/16-20	32,8	1.29	21,6	0.85	21,6	0.85
0406S	6,4	0.25	9/16-18	9/16-18	9/16-18	36,8	1.45	23,4	0.92	23,4	0.92
0604S	9,7	0.38	11/16-16	11/16-16	7/16-20	34,8	1.37	29,7	1.17	24,9	0.98
0606S	9,7	0.38	11/16-16	11/16-16	9/16-18	36,8	1.45	24,9	0.98	24,9	0.98
0806S	12,7	0.50	13/16-16	13/16-16	9/16-18	36,6	1.44	27,9	1.10	27,9	1.10
0808S	12,7	0.50	13/16-16	13/16-16	3/4-16	40,6	1.60	27,9	1.10	27,9	1.10
0812S	12,7	0.50	13/16-16	13/16-16	1 1/16-12	55,1	2.17	33,5	1.32	33,5	1.32
1010S	16,0	0.63	1-14	1-14	7/8-14	50,0	1.97	33,3	1.31	33,3	1.31
1012S	16,0	0.63	1-14	1-14	1 1/16-12	55,1	2.17	35,8	1.41	35,8	1.41
1212S	19,0	0.75	1 3/16-12	1 3/16-12	1 1/16-12	55,1	2.17	37,3	1.47	37,3	1.47
1220S	19,0	0.75	1 3/16-12	1 3/16-12	1 5/8-12	62,2	2.45	44,2	1.74	44,2	1.74
1616S	25,4	1.00	1 7/16-12	1 7/16-12	1 5/16-12	59,7	2.35	41,7	1.64	41,7	1.64
2020S	31,8	1.25	1 11/16-12	1 11/16-12	1 5/8-12	62,2	2.45	44,7	1.76	44,7	1.76
2424S	38,1	1.50	2-12	2-12	1 7/8-12	65,8	2.59	48,8	1.92	48,8	1.92
0005S	-	-	1 7/16-12	1 3/16-12	1 1/16-12	58,9	2.32	41,7	1.64	41,1	1.62
0001S	-	-	1 7/16-12	1 3/16-12	1 5/16-12	59,7	2.35	41,7	1.64	41,1	1.62
0003S	-	-	1-14	13/16-16	1 1/16-12	55,1	2.17	35,8	1.41	33,5	1.32

Adapters and tube fittings

ORS/NPTF

J

ORS/NPTF

ORS/male NPTF adapter

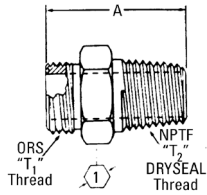

Part no. FF2031T-(Dash size) (Ref. SAE 520102)

Dash size	Tube O. D.		Thread T1	Thread T2	A		①	
	mm	in			mm	in	mm	in
0402S	6,4	0.25	9/16-18	1/8-27	26,2	1.03	15,7	0.62
0404S	6,4	0.25	9/16-18	1/4-18	31,5	1.24	15,7	0.62
0406S	6,4	0.25	9/16-18	3/8-18	31,5	1.24	19,1	0.75
0408S	6,4	0.25	9/16-18	1/2-14	37,8	1.49	22,4	0.88
0602S	9,7	0.38	11/16-16	1/8-27	28,4	1.12	19,1	0.75
0604S	9,7	0.38	11/16-16	1/4-18	33,0	1.30	19,1	0.75
0606S	9,7	0.38	11/16-16	3/8-18	33,0	1.30	19,1	0.75
0608S	9,7	0.38	11/16-16	1/2-14	39,4	1.55	22,4	0.88
0804S	12,7	0.50	13/16-16	1/4-18	34,5	1.36	22,4	0.88
0806S	12,7	0.50	13/16-16	3/8-18	34,5	1.36	22,4	0.88
0808S	12,7	0.50	13/16-16	1/2-14	40,9	1.61	22,4	0.88
0812S	12,7	0.50	13/16-16	3/4-14	42,7	1.68	26,9	1.06
1006S	16,0	0.63	1-14	3/8-18	37,3	1.47	26,9	1.06
1008S	16,0	0.63	1-14	1/2-14	43,7	1.72	26,9	1.06
1012S	16,0	0.63	1-14	3/4-14	45,2	1.78	26,9	1.06
1016S	16,0	0.63	1-14	1-11 1/2	50,0	1.97	35,1	1.38
1208S	19,0	0.75	1 3/16-12	1/2-14	46,7	1.84	31,8	1.25
1212S	19,0	0.75	1 3/16-12	3/4-14	46,7	1.84	31,8	1.25
1216S	19,0	0.75	1 3/16-12	1-11 1/2	51,6	2.03	35,1	1.38
1612S	25,4	1.00	1 7/16-12	3/4-14	47,2	1.86	38,1	1.50
1616S	25,4	1.00	1 7/16-12	1-11 1/2	52,1	2.05	38,1	1.50
1620S	25,4	1.00	1 7/16-12	1 1/4-11 1/2	54,9	2.16	42,9	1.69
2008S	31,8	1.25	1 11/16-12	1/2-14	49,3	1.94	44,5	1.75
2016S	31,8	1.25	1 11/16-12	1-11 1/2	54,1	2.13	44,5	1.75
2020S	31,8	1.25	1 11/16-12	1 1/4-11 1/2	54,9	2.16	44,5	1.75
2424S	38,1	1.50	2-12	1 1/2-11 1/2	57,4	2.26	53,8	2.12

45° ORS/male NPTF adapter

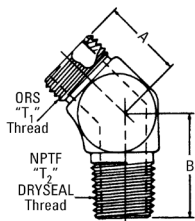

Part no. FF2093T-(Dash size) (Ref. SAE 520302)

Dash size	Tube O. D.		Thread T1	Thread T2	A		B	
	mm	in			mm	in	mm	in
0402S	6,4	0.25	9/16-18	1/8-27	16,0	0.63	17,3	0.68
0404S	6,4	0.25	9/16-18	1/4-18	17,3	0.68	23,6	0.93
0406S	6,4	0.25	9/16-18	3/8-18	17,0	0.67	26,9	1.06
0604S	9,7	0.38	11/16-16	1/4-18	18,8	0.74	23,6	0.93
0606S	9,7	0.38	11/16-16	3/8-18	18,8	0.74	26,4	1.04
0608S	9,7	0.38	11/16-16	1/2-14	19,3	0.76	30,7	1.21
0806S	12,7	0.50	13/16-16	3/8-18	20,3	0.80	26,4	1.04
0808S	12,7	0.50	13/16-16	1/2-14	20,8	0.82	30,5	1.20
1008S	16,0	0.63	1-14	1/2-14	23,4	0.92	30,5	1.20
1212S	19,0	0.75	1 3/16-12	3/4-14	25,9	1.02	31,2	1.23
1616S	25,4	1.00	1 7/16-12	1-11 1/2	30,0	1.18	38,3	1.51
2020S	31,8	1.25	1 11/16-12	1 1/4-11 1/2	32,0	1.26	42,9	1.69
2424S	38,1	1.50	2-12	1 1/2-11 1/2	36,8	1.45	45,7	1.80

ORS/NPTF

90° ORS/male NPTF adapter

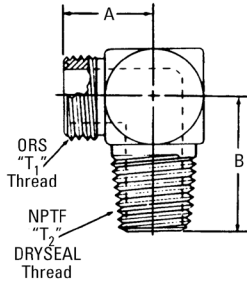

Part no. FF2032T-(Dash size) (Ref. SAE 520202)

Dash size	Tube O. D.		Thread T1	Thread T2	A		B	
	mm	in			mm	in	mm	in
0402S	6,4	0.25	9/16-18	1/8-27	21,6	0.85	21,3	0.84
0404S	6,4	0.25	9/16-18	1/4-18	23,4	0.92	29,2	1.15
0406S	6,4	0.25	9/16-18	3/8-18	24,4	0.96	31,8	1.25
0602S	9,7	0.38	11/16-16	1/8-27	24,9	0.98	24,4	0.96
0604S	9,7	0.38	11/16-16	1/4-18	24,9	0.98	29,2	1.15
0606S	9,7	0.38	11/16-16	3/8-18	26,4	1.04	31,8	1.25
0608S	9,7	0.38	11/16-16	1/2-14	29,2	1.15	38,9	1.53
0802S	12,7	0.50	13/16-16	1/8-27	27,9	1.10	22,1	0.87
0806S	12,7	0.50	13/16-16	3/8-18	27,9	1.10	31,8	1.25
0808S	12,7	0.50	13/16-16	1/2-14	30,7	1.21	38,9	1.53
0812S	12,7	0.50	13/16-16	3/4-14	33,5	1.32	41,9	1.65
1008S	16,0	0.63	1-14	1/2-14	33,3	1.31	38,9	1.53
1012S	16,0	0.63	1-14	3/4-14	35,8	1.41	41,9	1.65
1208S	19,0	0.75	1 3/16-12	1/2-14	37,3	1.47	41,9	1.65
1212S	19,0	0.75	1 3/16-12	3/4-14	37,3	1.47	41,9	1.65
1216S	19,0	0.75	1 3/16-12	1-11 1/2	41,1	1.62	51,6	2.03
1612S	25,4	1.00	1 7/16-12	3/4-14	41,7	1.64	46,7	1.84
1616S	25,4	1.00	1 7/16-12	1-11 1/2	41,7	1.64	51,6	2.03
2016S	31,8	1.25	1 11/16-12	1-11 1/2	44,7	1.76	60,5	2.38
2020S	31,8	1.25	1 11/16-12	1 1/4-11 1/2	44,7	1.76	61,2	2.41
2424S	38,1	1.50	2-12	1 1/2-11 1/2	48,8	1.92	68,6	2.70

ORS/ORS/male NPTF adapter

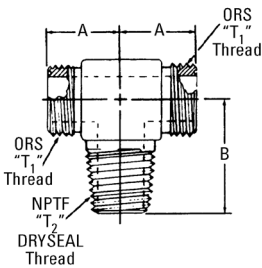

Part no. FF2001T-(Dash size) (Ref. SAE 520425)

Dash size	Tube O. D.		Thread T1	Thread T2	A		B	
	mm	in			mm	in	mm	in
0402S	6,4	0.25	9/16-18	1/8-27	21,6	0.85	19,8	0.78
0404S	6,4	0.25	9/16-18	1/4-18	23,4	0.92	27,4	1.08
0604S	9,7	0.38	11/16-16	1/4-18	24,9	0.98	27,4	1.08
0606S	9,7	0.38	11/16-16	3/8-18	26,4	1.04	30,7	1.21
0806S	12,7	0.50	13/16-16	3/8-18	27,9	1.10	30,7	1.21
0808S	12,7	0.50	13/16-16	1/2-14	30,7	1.21	38,9	1.53
1206S	19,0	0.75	13/16-12	3/8-18	37,3	1.47	37,1	1.46
1212S	19,0	0.75	1 3/16-12	3/4-14	37,3	1.47	41,9	1.65
1616S	25,4	1.00	1 7/16-12	1-11 1/2	41,6	1.64	51,6	2.03
2424S	38,1	1.50	2-12	1 1/2-11 1/2	48,8	1.92	68,6	2.70

Adapters and tube fittings

ORS to SAE 37° (JIC) flare

J

ORS to SAE 37° flare

ORS female swivel/SAE 37° male flare

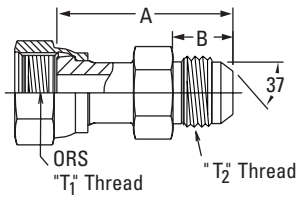

Part no. FF2209T-(Dash size)

Dash size	Tube O. D.		Thread T1	Thread T2	A		B	
	mm	in			mm	in	mm	in
0412S	6,4	0.25	9/16-18	1 1/16-12	50,5	1.99	21,8	0.86
0612S	9,7	0.38	11/16-16	1 1/16-12	52,6	2.07	21,8	0.86
0808S	12,7	0.50	13/16-16	3/4-16	51,6	2.03	16,8	0.66
0812S	12,7	0.50	13/16-16	1 1/16-12	57,2	2.25	21,8	0.86
1212S	19,0	0.75	1 3/16-12	1 1/16-12	62,0	2.44	21,8	0.86
1616S	25,4	1.00	1 7/16-12	1 5/16-12	71,6	2.82	23,1	0.91
2016S	31,8	1.25	1 11/16-12	1 5/16-12	73,1	2.88	23,1	0.91

Male ORS/SAE 37° male flare

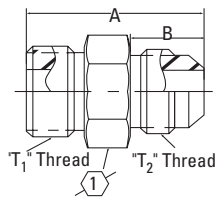

Part no. FF2313T-(Dash size)

Dash size	Tube O. D.		Thread T1	Thread T2	A		B		①
	mm	in			mm	in	mm	in	
0808S	12,7	0.50	13/16-16	3/4-16	39,1	1.54	16,8	0.66	22,3 0.88
1010S	16,0	0.63	1-14	7/8-14	46,5	1.83	19,3	0.76	26,9 1.06
1212S	19,0	0.75	1 3/16-12	1 1/16-12	52,1	2.05	21,8	0.86	31,8 1.25

ORS/ORS

ORS/ORS adapter

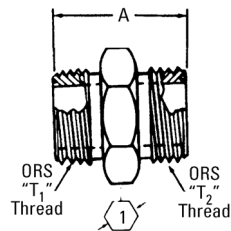

Part no. FF2000T-(Dash size) (Ref. SAE 520101)

Dash size	Tube O. D.		Thread T1	Thread T2	A		①
	mm	in			mm	in	
0404S	6,4	0.25	9/16-18	9/16-18	27,4	1.08	15,7 0.62
0604S	9,7	0.38	11/16-16	9/16-18	29,7	1.17	19,0 0.75
0606S	9,7	0.38	11/16-16	11/16-16	31,0	1.22	19,0 0.75
0806S	12,7	0.50	13/16-16	11/16-16	33,8	1.33	22,3 0.88
0808S	12,7	0.50	13/16-16	13/16-16	35,3	1.39	22,3 0.88
1008S	16,0	0.63	1-14	13/16-16	39,9	1.57	26,9 1.06
1010S	16,0	0.63	1-14	1-14	42,7	1.68	26,9 1.06
1208S	19,0	0.75	1 3/16-12	13/16-16	42,9	1.69	31,8 1.25
1210S	19,0	0.75	1 3/16-12	1-14	45,7	1.80	31,8 1.25
1212S	19,0	0.75	1 3/16-12	1 3/16-12	47,2	1.86	31,8 1.25
1612S	25,4	1.00	1 7/16-12	1 3/16-12	48,8	1.92	38,1 1.50
1616S	25,4	1.00	1 7/16-12	1 7/16-12	49,3	1.94	38,1 1.50
2020S	31,8	1.25	1 11/16-12	1 11/16-12	51,3	2.02	44,4 1.75
2424S	38,1	1.50	2-12	2-12	53,1	2.09	53,9 2.12

ORS/ORS

ORS/ORS reducer adapter

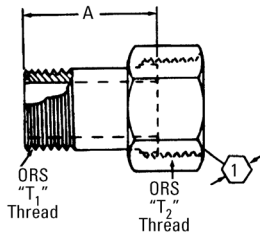

Part no. FF2281T-(Dash size) (Ref. SAE 520123)

Dash size	Tube O. D.		Thread T1	Thread T2	A		①
	mm	in			mm	in	
0406S	9,7	0.38	9/16-18	11/16-16	19,5	0.77	20,6 0.81
0408S†	12,7	0.50	9/16-18	13/16-16	21,8	0.86	23,9 0.94
0410S†	16,0	0.63	9/16-18	1-14	22,9	0.90	28,5 1.12
0412S†	19,0	0.75	9/16-18	1 3/16-12	24,9	0.98	35,1 1.38
0608S	12,7	0.50	11/16-16	13/16-16	22,3	0.88	23,9 0.94
0610S†	16,0	0.63	11/16-16	1-14	24,1	0.95	28,5 1.12
0612S†	19,0	0.75	11/16-16	1 3/16-12	26,2	1.03	35,1 1.38
0810S†	16,0	0.63	13/16-16	1-14	25,9	1.02	28,5 1.12
0812S†	19,0	0.75	13/16-16	1 3/16-12	27,9	1.10	35,1 1.38
0816S†	25,4	1.00	13/16-16	1 7/16-12	29,2	1.15	41,1 1.62
1216S	25,4	1.00	1 3/16-12	1 7/16-12	34,0	1.34	41,1 1.62
1220S†	31,8	1.25	1 3/16-12	1 11/16-12	33,5	1.32	47,7 1.88
1224S†	38,1	1.50	1 3/16-12	2-12	33,6	1.32	57,2 2.25
1620S	31,8	1.25	1 7/16-12	1 11/16-12	37,3	2.69	47,7 1.88
1624S†	38,1	1.50	1 7/16-12	2-12	34,0	1.34	57,2 2.25

† Available without nut. Order by part number FF2151T (Size).

ORS/ORS bulkhead adapter

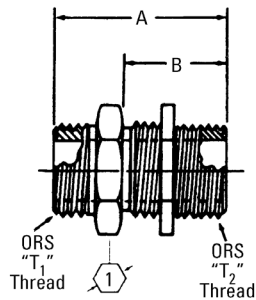

Part no. FF1994T-(Dash size) (Ref. SAE 520601)

Dash size	Tube O. D.		Thread T1	Thread T2	A		B		①
	mm	in			mm	in	mm	in	
0404S	6,4	0.25	9/16-18	9/16-18	48,3	1.90	31,5	1.24	20,6 0.81
0606S	9,7	0.38	11/16-16	11/16-16	53,1	2.09	34,0	1.34	25,4 1.00
0608S	9,7	0.38	11/16-16	13/16-16	56,9	2.24	36,6	1.44	28,4 1.12
0808S	12,7	0.50	13/16-16	13/16-16	58,4	2.30	36,6	1.44	28,4 1.12
1008S	16,0	0.63	1-14	13/16-16	63,8	2.51	36,6	1.44	28,4 1.12
1010S	16,0	0.63	1-14	1-14	66,5	2.62	40,6	1.60	33,3 1.31
1212S	19,0	0.75	1 3/16-12	1 3/16-12	69,1	2.72	41,7	1.64	38,1 1.50
1616S	25,4	1.00	1 7/16-12	1 7/16-12	70,1	2.76	42,2	1.66	44,5 1.75
2016S	31,8	1.25	1 11/16-12	1 7/16-12	70,1	2.76	42,2	1.66	44,5 1.75
2020S	31,8	1.25	1 11/16-12	1 11/16-12	70,1	2.76	42,2	1.66	50,8 2.00
2424S	38,1	1.50	2-12	2-12	70,1	2.76	42,2	1.66	60,5 2.38

45° ORS/ORS female adapter

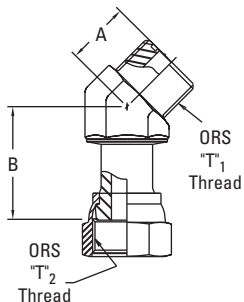

Part no. FF2133T-(Dash size)

Dash size	Tube O. D.		Thread T1	Thread T2	A		B	
	mm	in			mm	in	mm	in
0606S	9,7	0.38	11/16-16	11/16-16	18,8	0.74	26,9	1.06
0808S	12,7	0.50	13/16-16	13/16-16	20,3	0.80	35,6	1.40
1010S	16,0	0.63	1-14	1-14	23,4	0.92	38,6	1.52
1212S	19,0	0.75	1 3/16-12	1 3/16-12	25,9	1.02	42,4	1.67
1616S	25,4	1.00	1 7/16-12	1 7/16-12	30,0	1.18	42,9	1.69

Adapters and tube fittings

ORS /ORS

J

ORS/ORS

45° ORS/ORS bulkhead adapter

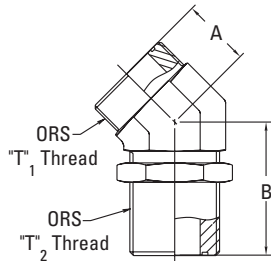

Part no. FF2144T-(Dash size) (Ref. SAE 520801)

Dash size	Tube O. D.		Thread T1	Thread T2	A		B	
	mm	in			mm	in	mm	in
0404S	6,4	0.25	9/16-18	9/16-18	16,0	0.63	43,9	1.73
0606S	9,7	0.38	11/16-16	11/16-16	18,8	0.74	48,5	1.91
0808S	12,7	0.50	13/16-16	13/16-16	20,3	0.80	51,1	2.01
1212S	19,0	0.75	1 3/16-12	1 3/16-12	25,9	1.02	60,7	2.39
1616S	25,4	1.00	1 7/16-12	1 7/16-12	30,0	1.18	65,3	2.57

90° ORS/ORS female adapter

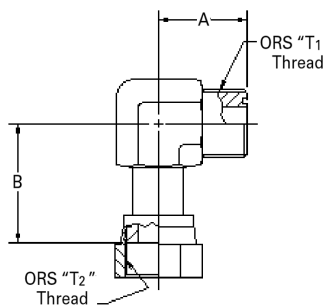

Part no. FF2098T-(Dash size) (Ref. SAE 520221)

Dash size	Tube O. D.		Thread T1	Thread T2	A		B	
	mm	in			mm	in	mm	in
0404S	6,4	0.25	9/16-18	9/16-18	21,6	0.85	26,4	1.04
0606S	9,7	0.38	11/16-16	11/16-16	24,9	0.98	29,2	1.15
0808S	12,7	0.50	13/16-16	13/16-16	27,9	1.10	37,8	1.49
1010S	16,0	0.63	1-14	1-14	33,3	1.31	41,1	1.62
1212S	19,0	0.75	1 3/16-12	1 3/16-12	37,3	1.47	46,2	1.82
1616S	25,4	1.00	1 7/16-12	1 7/16-12	41,7	1.64	53,3	2.10
2020S	31,8	1.25	1 11/16-12	1 11/16-12	44,7	1.76	58,2	2.29
2424S	38,1	1.50	2-12	2-12	48,8	1.92	61,2	2.41

90° ORS/ORS adapter

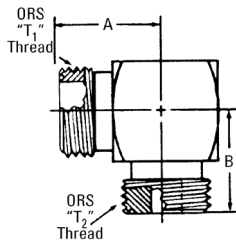

Part no. FF2035T-(Dash size) (Ref. SAE 520201)

Dash size	Tube O. D.		Thread T1	Thread T2	A		B	
	mm	in			mm	in	mm	in
0404S	6,4	0.25	9/16-18	9/16-18	21,6	0.85	21,6	0.85
0604S	9,7	0.38	11/16-16	9/16-18	24,9	0.98	23,4	0.92
0606S	9,7	0.38	11/16-16	11/16-16	24,9	0.98	24,9	0.98
0808S	12,7	0.50	13/16-16	13/16-16	27,9	1.10	27,9	1.10
1010S	16,0	0.63	1-14	1-14	33,3	1.31	33,3	1.31
1212S	19,0	0.75	1 3/16-12	1 3/16-12	37,3	1.47	37,3	1.47
1616S	25,4	1.00	1 7/16-12	1 7/16-12	41,6	1.64	41,6	1.64
2020S	31,8	1.25	1 11/16-12	1 11/16-12	44,7	1.76	44,7	1.76
2424S	38,1	1.50	2-12	2-12	48,8	1.92	48,8	1.92

ORS/ORS

90° ORS/ORS bulkhead adapter

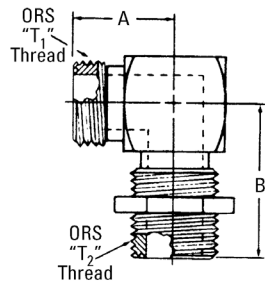

Part no. FF2030T-(Dash size) (Ref. SAE 520701)

Dash size	Tube O. D.		Thread T1	Thread T2	A		B		E	
	mm	in			mm	in	mm	in		
0404S	6,4	0.25	9/16-18	9/16-18	22,6	0.89	47,0	1.85	4,3	0.17
0606S	9,7	0.38	11/16-16	11/16-16	25,9	1.02	52,1	2.05	6,6	0.26
0806S	12,7	0.50	13/16-16	11/16-16	29,0	1.14	53,8	2.12	6,6	0.26
0808S	12,7	0.50	13/16-16	13/16-16	29,0	1.14	55,4	2.18	9,7	0.38
1010S	16,0	0.63	1-14	1-14	34,5	1.36	63,0	2.48	12,2	0.48
1212S	19,0	0.75	1 3/16-12	1 3/16-12	38,6	1.52	67,3	2.65	15,5	0.61
1616S	25,4	1.00	1 7/16-12	1 7/16-12	42,4	1.67	71,1	2.80	20,6	0.81
2020S	31,8	1.25	1 11/16-12	1 11/16-12	45,5	1.79	75,4	2.97	26,2	1.03
2424S	38,1	1.50	2-12	2-12	49,5	1.95	79,5	3.13	32,0	1.26

ORS/ORS/ORS

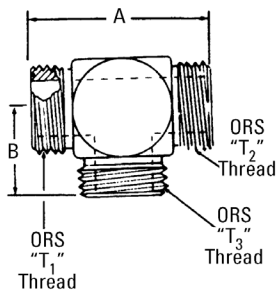

Part no. FF1898T-(Dash size) (Ref. SAE 520401)

Dash size	Tube O. D.		Thread T1	Thread T2	Thread T3	A		B	
	mm	in				mm	in	mm	in
0404S	6,4	0.25	9/16-18	9/16-18	9/16-18	43,2	1.70	21,6	0.85
0606S	9,7	0.38	11/16-16	11/16-16	11/16-16	49,8	1.96	24,9	0.98
0608S	9,7	0.38	11/16-16	11/16-16	13/16-16	52,8	2.08	27,9	1.10
0808S	12,7	0.50	13/16-16	13/16-16	13/16-16	55,9	2.20	27,9	1.10
1010S	16,0	0.63	1-14	1-14	1-14	66,5	2.62	33,3	1.31
1212S	19,0	0.75	1 3/16-12	1 3/16-12	1 3/16-12	74,7	2.94	37,3	1.47
1216S	19,0	0.75	1 3/16-12	1 3/16-12	1 7/16-12	82,3	3.24	44,7	1.76
1616S	25,4	1.00	1 7/16-12	1 7/16-12	1 7/16-12	83,3	3.28	41,6	1.64
2016S	31,8	1.25	1 11/16-12	1 11/16-12	1 7/16-12	89,4	3.52	44,7	1.76
2020S	31,8	1.25	1 11/16-12	1 11/16-12	1 11/16-12	89,4	3.52	44,7	1.76
2424S	38,1	1.50	2-12	2-12	2-12	97,5	3.84	48,8	1.92

ORS - bulkhead run tee

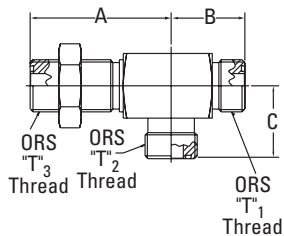

Part no. FF2174T-(Dash size) (Ref. SAE 520958)

Dash size	Tube O. D.		Thread T1	Thread T2	Thread T3	A		B		C	
	mm	in				mm	in	mm	in	mm	in
0404S	6,4	0.25	9/16-18	9/16-18	9/16-18	47,0	1.85	22,6	0.89	22,6	0.89
0606S	9,7	0.38	11/16-16	11/16-16	11/16-16	52,0	2.05	25,9	1.02	25,7	1.01
0808S	12,7	0.50	13/16-16	13/16-16	13/16-16	55,4	2.18	29,0	1.14	28,7	1.13
1212S	19,0	0.75	1 3/16-12	1 3/16-12	1 3/16-12	54,9	2.16	40,6	1.60	40,6	1.60
1616S	25,4	1.00	1 7/16-12	1 7/16-12	1 7/16-12	71,1	2.80	42,4	1.67	42,4	1.67

Adapters and tube fittings

ORS /ORS

J

ORS/ORS

ORS/ORS/ORS female adapter

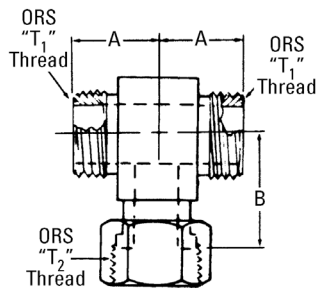

Part no. FF1857T-(Dash size) (Ref. SAE 520433)

Dash size	Tube O. D.		Thread T1	Thread T2	A		B	
	mm	in			mm	in	mm	in
0404S	6,4	0.25	9/16-18	9/16-18	21,6	0.85	26,4	1.04
0606S	9,7	0.38	11/16-16	11/16-16	24,9	0.98	29,2	1.15
0808S	12,7	0.50	13/16-16	13/16-16	27,9	1.10	37,8	1.49
1010S	16,0	0.63	1-14	1-14	33,3	1.31	41,1	1.62
1212S	19,0	0.75	1 3/16-12	1 3/16-12	37,3	1.47	46,2	1.82
1616S	25,4	1.00	1 7/16-12	1 7/16-12	41,6	1.64	53,3	2.10
2020S	31,8	1.25	1 11/16-12	1 11/16-12	44,7	1.76	58,2	2.29

ORS/ORS female/ORS adapter

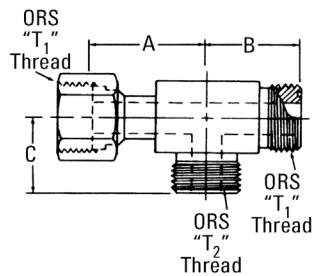

Part no. FF2114T-(Dash size) (Ref. SAE 520432)

Dash size	Tube O. D.		Thread T1	Thread T2	A		B		C	
	mm	in			mm	in	mm	in	mm	in
0404S	6,4	0.25	9/16-18	9/16-18	26,4	1.04	21,6	0.85	21,6	0.85
0606S	9,7	0.38	11/16-16	11/16-16	29,2	1.15	24,9	0.98	24,9	0.98
0808S	12,7	0.50	13/16-16	13/16-16	37,8	1.49	27,9	1.10	27,9	1.10
1010S	16,0	0.63	1-14	1-14	41,1	1.62	33,3	1.31	33,3	1.31
1212S	19,0	0.75	1 3/16-12	1 3/16-12	46,2	1.82	37,3	1.47	37,3	1.47
1616S	25,4	1.00	1 7/16-12	1 7/16-12	53,3	2.10	41,7	1.64	41,7	1.64
2020S	31,8	1.25	1 11/16-12	1 11/16-12	58,2	2.29	44,7	1.76	44,7	1.76
2424S	38,1	1.50	2-12	2-12	61,2	2.41	48,8	1.92	48,8	1.92

ORS/ORS/ORS bulkhead adapter

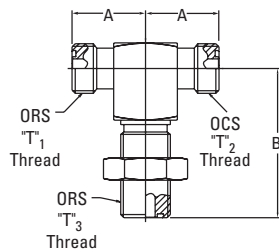

Part no. FF2033T-(Dash size) (Ref. SAE 520959)

Dash size	Tube O. D.		Thread T1	Thread T2	Thread T3	A		B	
	mm	in				mm	in	mm	in
0404S	6,4	0.25	9/16-18	9/16-18	9/16-18	22,6	0.89	47,0	1.85
0606S	9,7	0.38	11/16-16	11/16-16	11/16-16	25,7	1.01	52,0	2.05
0808S	12,7	0.50	13/16-16	13/16-16	13/16-16	28,7	1.13	55,4	2.18
1010S	16,0	0.63	1-14	1-14	1-14	34,5	1.36	63,0	2.48
1212S	19,0	0.75	1 3/16-12	1 3/16-12	1 3/16-12	40,6	1.60	67,3	2.65
1616S	25,4	1.00	1 7/16-12	1 7/16-12	1 7/16-12	42,4	1.67	71,1	2.80

ORS accessories

ORS Bulkhead Nut

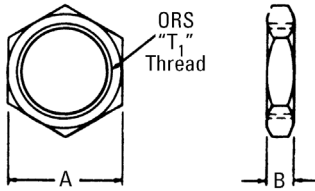

Part no. FF9768-(Dash size) (Ref. SAE 520118)

Dash size	Tube O. D.		Thread T1	A		B	
	mm	in		mm	in	mm	in
04S	6,4	0.25	9/16-18	20,6	0.81	6,8	0.27
06S	9,7	0.38	11/16-16	25,4	1.00	7,9	0.31
08S	12,7	0.50	13/16-16	28,5	1.12	8,9	0.35
10S	16,0	0.63	1-14	33,3	1.31	10,4	0.41
12S	19,0	0.75	1 3/16-12	38,1	1.50	10,4	0.41
16S	25,4	1.00	1 7/16-12	44,4	1.75	10,4	0.41
20S	31,8	1.25	1 11/16-12	50,8	2.00	10,4	0.41
24S	38,1	1.50	2-12	60,4	2.38	10,4	0.41

ORS plug

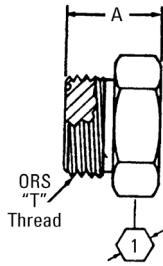

Part no. FF9767T-(Dash size) (Ref. SAE 520109)

Dash size	Tube O. D.		Thread T1	A		①	
	mm	in		mm	in	mm	in
04-S	6,4	0.25	9/16-18	16,8	0.66	15,7	0.62
06-S	9,7	0.38	11/16-16	19,1	0.75	19,1	0.75
08-S	12,7	0.50	13/16-16	22,1	0.87	22,4	0.88
10-S	16,0	0.63	1-14	25,9	1.02	26,9	1.06
12-S	19,0	0.75	1 3/16-12	27,4	1.08	31,8	1.25
16-S	25,4	1.00	1 7/16-12	27,9	1.10	38,1	1.50
20-S	31,8	1.25	1 11/16-12	27,9	1.10	44,5	1.75
24-S	38,1	1.50	2-12	27,9	1.10	53,8	2.12

ORS cap assembly

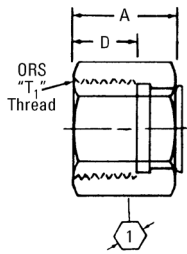

Part no. FF9863-(Dash size) (Ref. SAE 520112)

Dash size	Tube O. D.		Thread T1	A		D		①	
	mm	in		mm	in	mm	in	mm	in
04S	6,4	0.25	9/16-18	16,8	0.66	8,1	0.32	17,5	0.69
06S	9,7	0.38	11/16-16	19,1	0.75	9,7	0.38	20,6	0.81
08S	12,7	0.50	13/16-16	22,9	0.90	10,9	0.43	23,9	0.94
10S	16,0	0.63	1-14	25,4	1.00	13,5	0.53	28,4	1.12
12S	19,0	0.75	1 3/16-12	27,9	1.10	14,5	0.57	35,1	1.38
16S	25,4	1.00	1 7/16-12	29,7	1.17	14,7	0.58	41,1	1.62
20S	31,8	1.25	1 11/16-12	29,7	1.17	14,7	0.58	47,8	1.88
24S	38,1	1.50	2-12	29,7	1.17	14,7	0.58	57,2	2.25

Adapters and tube fittings

ORS accessories

J

ORS accessories

ORS cap (use with FC2326 nut)

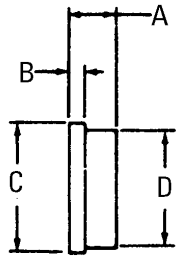

Part no. FF9766-(Dash size)

Dash size	Tube O. D.		A		B		C		D	
	mm	in	mm	in	mm	in	mm	in	mm	in
04S	6,4	0.25	8,6	0.34	4,1	0.16	12,7	0.50	10,2	0.40
06S	9,7	0.38	9,4	0.37	4,6	0.18	15,7	0.62	13,2	0.52
08S	12,7	0.50	11,9	0.47	5,1	0.20	18,8	0.74	16,2	0.64
10S	16,0	0.63	11,9	0.47	6,1	0.24	23,4	0.92	20,8	0.82
12S	19,0	0.75	13,5	0.53	6,6	0.26	27,7	1.09	23,9	0.94
16S	25,4	1.00	15,0	0.59	7,1	0.28	34,0	1.34	28,7	1.13
20S	31,8	1.25	15,0	0.59	7,1	0.28	40,4	1.59	35,6	1.40
24S	38,1	1.50	15,0	0.59	7,1	0.28	48,5	1.91	43,4	1.71

ORS silver braze ring

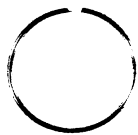

Part no. FF9075-(Dash size)

Dash size	Tube O. D.	
	mm	in
19	6,4	0.25
06	9,7	0.38
74	12,7	0.50
08	16,0	0.63
09	19,0	0.75
86	25,4	1.00
87	31,8	1.25
88	38,1	1.50

SAE O-Ring boss/SAE O-Ring boss

SAE O-Ring boss reducer

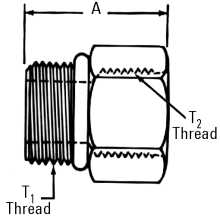

Part no. FF1010-(Dash size)

Dash size	Threads T1	Threads T2	A	
			mm	in
0304S	3/8-24	7/16-20	24,4	0.96
0406S	7/16-20	9/16-18	27,2	1.07
0408S	7/16-20	3/4-16	32,0	1.26
0506S	1/2-20	9/16-18	27,2	1.07
0604S	9/16-18	7/16-20	24,4	0.96
0608S	9/16-18	3/4-16	32,8	1.29
0804S	3/4-16	7/16-20	28,2	1.11
0806S	3/4-16	9/16-18	26,9	1.06
0808S	3/4-16	3/4-16	31,8	1.25
1005S	7/8-14	1/2-20	26,7	1.05
1006S	7/8-14	9/16-18	20,6	0.81
1008S	7/8-14	3/4-16	31,8	1.25
1010S	7/8-14	7/8-14	35,1	1.38
1012S	7/8-14	1 1/16-12	42,2	1.66
1206S	1 1/16-12	9/16-18	25,4	1.00
1208S	1 1/16-12	3/4-16	25,4	1.00
1210S	1 1/16-12	7/8-14	36,6	1.44
1216S	1 1/16-12	1 5/16-12	45,5	1.79
1412S	1 3/16-12	1 1/16-12	43,7	1.72
1606S	1 5/16-12	9/16-18	25,4	1.00
1608S	1 5/16-12	3/4-16	25,4	1.00
1610S	1 5/16-12	7/8-14	36,6	1.44
1612S	1 5/16-12	1 1/16-12	40,4	1.59
1620S	1 5/16-12	1 5/8-12	45,2	1.78
2010S	1 5/8-12	7/8-14	25,4	1.00
2012S	1 5/8-12	1 1/16-12	25,4	1.00
2016S	1 5/8-12	1 5/16-12	25,4	1.00
2412S	1 7/8-12	1 1/16-12	39,6	1.56
2416S	1 7/8-12	1 5/16-12	25,4	1.00
2420S	1 7/8-12	1 5/8-12	39,6	1.56
3224S	2 1/2-12	1 7/8-12	36,6	1.44

Note: Available without O-Ring, Order part No. FF1009-(dash size)

Adapters and tube fittings

SAE O-Ring boss /SAE O-Ring boss

J

SAE O-Ring boss/SAE O-Ring boss

O-Ring boss plug

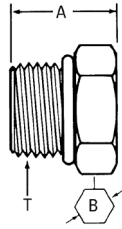

Part no. 900598-(Dash size) (Ref. SAE 090109A)

Dash size	Threads T1	A		B	
		mm	in	mm	in
4S	7/16-20	17,0	0.67	14,2	0.56
5S	1/2-20	17,0	0.67	15,7	0.62
6S	9/16-18	18,5	0.73	17,5	0.69
8S	3/4-16	20,3	0.80	22,4	0.88
10S	7/8-14	23,6	0.93	25,4	1.00
12S	1 1/16-12	27,7	1.09	31,8	1.25
14S	1 3/16-12	27,7	1.09	35,1	1.38
16S	1 5/16-12	28,4	1.12	38,1	1.50
20S	1 5/8-12	30,5	1.20	47,8	1.88
24S	1 7/8-12	32,3	1.27	53,8	2.12
32S	2 1/2-12	36,3	1.43	69,9	2.75
2S	5/16-24	15,2	0.60	11,2	0.44
3S	3/8-24	15,2	0.60	12,7	0.50

Note: Available without O-Ring. Order as 900598-1-(Dash size)

SAE male O-Ring boss (Hex socket)

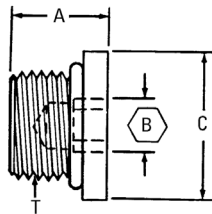

Part no. FF2138-(Dash size) (Ref. SAE 090109B)

Dash size	Tube O.D.		Threads T1	A		C (Round)		B Hex	
	mm	in		mm	in	mm	in	mm	in
02S	3,3	0.13	5/16-24	10,2	0.40	11,2	0.44	3,3	0.13
03S	4,8	0.19	3/8-24	10,2	0.40	12,7	0.50	4,0	0.16
04S	6,3	0.25	7/16-20	11,9	0.47	14,3	0.56	4,8	0.19
05S	7,9	0.31	1/2-20	11,9	0.47	16,0	0.63	5,6	0.22
06S	9,6	0.38	9/16-18	12,8	0.50	17,5	0.69	6,4	0.25
08S	12,7	0.5	3/4-16	14,7	0.58	22,3	0.88	8,0	0.32
10S	16,0	0.63	7/8-14	16,5	0.65	25,4	1.00	9,6	0.38
12S	19,0	0.75	1 1/16-12	19,6	0.77	31,8	1.25	14,4	0.57
14S	22,2	0.88	1 3/16-12	19,6	0.77	35,0	1.38	14,4	0.57
16S	25,4	1.00	1 5/16-12	19,6	0.77	38,1	1.50	16,0	0.63
20S	31,8	1.25	1 5/8-12	19,6	0.77	47,8	1.88	19,1	0.75

Note: Available without O-Ring. Order as FF2137-(Dash size)

SAE O-Ring boss/adjustable SAE O-Ring boss

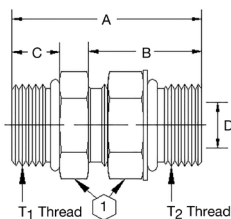

Part no. 2220-(Dash size)

Dash size	Threads T1	A		B		D Hole		E Hex		F Hex	
		mm	in	mm	in	mm	in	mm	in	mm	in
4-4S	7/16-20	34,8	1.37	9,1	0.38	4,3	0.17	14,3	0.56	14,3	0.56
6-6S	9/16-18	37,8	1.49	9,9	0.39	7,6	0.30	17,5	0.69	17,5	0.69
8-8S	3/4-16	44,4	1.75	11,1	0.44	9,9	0.39	22,2	0.88	22,2	0.88
10-10S	7/8-14	51,8	2.04	12,7	0.50	12,2	0.48	25,4	1.00	25,4	1.00
12-12S	1 1/16-12	54,1	2.13	15,0	0.59	15,5	0.61	31,8	1.25	31,8	1.25
16-16S	1 5/16-12	59,9	2.36	15,0	0.59	21,3	0.84	38,1	1.50	38,1	1.50
20-20S	1 5/8-12	58,9	2.32	15,0	0.59	27,4	1.08	47,6	1.88	47,6	1.88
24-24S	1 7/8-12	63,0	2.48	15,0	0.59	33,3	1.32	54,0	2.13	54,0	2.13

SAE O-Ring boss/SAE O-Ring boss

Male SAE O-Ring boss/male SAE O-Ring boss

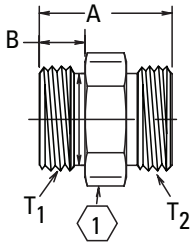

Part no. 2229-(Dash size)

Dash size	Tube O.D.		Threads T1	Thread T2	A		B		①
	mm	in			mm	in	mm	in	
8-8S	12,7	0.50	3/4-16	3/4-16	30,3	1.19	11,2	0.44	22,3 0.88
16-16S	25,4	1.00	1 5/16-12	1 5/16-12	43,9	1.73	15,0	0.59	38,1 1.50

90° female SAE O-Ring boss/adjustable SAE O-Ring boss male

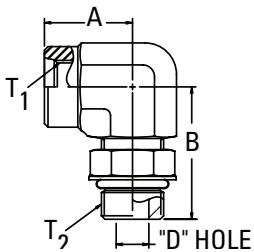

Part no. FF2591-(Dash size)

Dash size	Tube O.D.		Threads T1	Thread T2	A		B	
	mm	in			mm	in	mm	in
0404S	6,4	0.25	7/16-20	7/16-20	21,6	0.85	32,0	1.26
0606S	9,5	0.38	9/16-18	9/16-18	23,9	0.94	37,8	1.49

SAE O-Ring boss (adj.)/hose connector

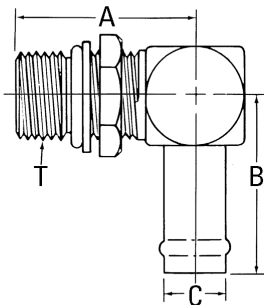

Part no. FF1167-(Dash size)

Dash size	Tube O.D.		Threads T1	A		B		C	
	mm	in		mm	in	mm	in	mm	in
0808S	12,7	0.5	3/4-16	39,0	1.54	40,4	1.60	12,7	0.50
1010S	16,0	0.63	7/8-14	43,4	1.70	52,3	2.06	16,0	0.63
1212S	19,0	0.75	1 1/16-12	49,8	1.96	52,3	2.06	19,0	0.75
2020S	31,7	1.25	1 5/8-12	55,9	2.20	60,5	2.38	31,7	1.25

Note: Available without O-Ring. Order by Part no. FF1161- (Dash size).
Clamp required.

Adapters and tube fittings

Pipe to Pipe

J

Pipe to pipe

Nipple-external pipe/external pipe

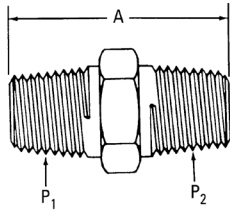

Part no. 2083-(Dash size) (Ref. SAE 140137)

Dash size	Threads P1	Thread P2	A	
			mm	in
1-1S	1/16-27	1/16-27	23,9	0.94
2-1S	1/8-27	1/16-27	24,6	0.97
2-2S	1/8-27	1/8-27	26,9	1.06
4-2S	1/4-18	1/8-27	32,0	1.26
4-4S	1/4-18	1/4-18	36,8	1.45
6-2S	3/8-18	1/8-27	31,8	1.25
6-4S	3/8-18	1/4-18	36,8	1.45
6-6S	3/8-18	3/8-18	36,8	1.45
8-4S	1/2-14	1/4-18	43,2	1.70
8-6S	1/2-14	3/8-18	43,2	1.70
8-8S	1/2-14	1/2-14	48,0	1.89
12-6S	3/4-14	3/8-18	45,0	1.77
12-8S	3/4-14	1/2-14	49,8	1.96
12-12S	3/4-14	3/4-14	49,8	1.96
16-12S	1-11 1/2	3/4-14	54,6	2.15
16-16S	1-11 1/2	1-11 1/2	59,4	2.34
20-16S	1 1/4-11 1/2	1-11 1/2	62,2	2.45
20-20S	1 1/4-11 1/2	1 1/4-11 1/2	63,0	2.48
24-24S	1 1/2-11 1/2	1 1/2-11 1/2	66,3	2.61
32-32S	2-11 1/2	2-11 1/2	71,6	2.82

Note: Also available in stainless steel as part no. 259-2083

External pipe/external pipe (NPSM)

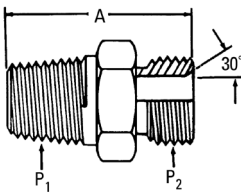

Part no. 2015-(Dash size)

Dash size	Threads P1	Thread P2	A	
			mm	in
8-8S	1/2-14	1/2-14	38,1	1.50
12-12S	3/4-14	3/4-14	41,1	1.62
16-16S	1-11 1/2	1-11 1/2	48,5	1.91
24-24S	1 1/2-11 1/2	1 1/2-11 1/2	54,4	2.14

Pipe to pipe

Nipple-external pipe/external pipe

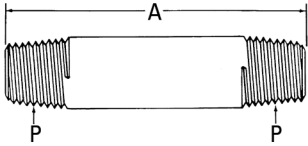

Part no. 2084-(Dash size)

Dash size	Threads T1	A	
		mm	in
2S-3/4	1/8-27	19,0	0.75
2S-2	1/8-27	50,8	2.00
4S-7/8	1/4-18	22,3	0.88
6S-1	3/8-18	25,4	1.00
6S-2	3/8-18	50,8	2.00
6S-3	3/8-18	76,2	3.00
6S-4	3/8-18	101,6	4.00
6S-6	3/8-18	152,4	6.00
8S-1 1/8	1/8-14	28,5	1.12
8S-2 1/2	1/2-14	63,5	2.50
12S-1 3/8	3/4-14	35,1	1.38
16S-1 1/2	1-11 1/2	38,1	1.50
20S-1 5/8	1 1/4-11 1/2	41,1	1.62
24S-1 3/4	1 1/2-11 1/2	44,4	1.75

Reducer-external pipe/internal pipe

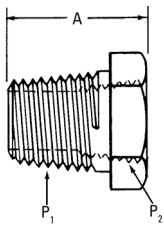

Part no. 2081-(Dash size) (Ref. SAE 140140)

Dash size	Thread P1	Thread P2	A	
			mm	in
2081-4-2S	1/4-18	1/8-27	21,6	0.85
2081-6-2S	3/8-18	1/8-27	21,6	0.85
2081-6-4S	3/8-18	1/4-18	25,4	1.00
2081-8-2S	1/2-14	1/8-27	27,9	1.10
2081-8-4S	1/2-14	1/4-18	27,9	1.10
2081-8-6S	1/2-14	3/8-18	28,4	1.12
2081-12-4S	3/4-14	1/4-14	29,7	1.17
2081-12-6S	3/4-14	3/8-18	29,7	1.17
2081-12-8S	3/4-14	1/2-14	34,5	1.36
2081-16-4S	1-11 1/2	1/4-18	34,5	1.36
2081-16-6S	1-11 1/2	3/8-14	34,5	1.36
2081-16-8S	1-11 1/2	1/2-14	34,5	1.36
2081-16-12S	1-11 1/2	3/4-14	37,8	1.49
2081-20-8S	1 1/4-11 1/2	1/2-14	37,3	1.47
2081-20-12S	1 1/4-11 1/2	3/4-14	37,3	1.47
2081-20-16S	1 1/4-11 1/2	1-11 1/2	40,9	1.61
2081-24-12S	1 1/2-11 1/2	3/4-14	39,9	1.57
2081-24-16S	1 1/2-11 1/2	1-11 1/2	39,9	1.57
2081-24-20S	1 1/2-11 1/2	1 1/4-11 1/2	39,9	1.57
2081-32-16S	2-11 1/2	1-11 1/2	44,5	1.75
2081-32-20S	2-11 1/2	1 1/4-11 1/2	44,5	1.75
2081-32-24S	2-11 1/2	1 1/2-11 1/2	44,5	1.75

Note: Also available in stainless steel as part no. 259-2081

Adapters and tube fittings

Pipe to Pipe

J

Pipe to pipe

External Pipe/Plug

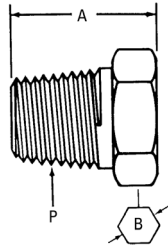

Part no. 2082-(Dash size) (Ref. SAE 140109E)

Dash size	Threads P1	A		B	
		mm	in	mm	in
2S	1/8-27	14,7	0.58	11,2	0.44
4S	1/4-18	19,3	0.76	14,2	0.56
6S	3/8-18	20,1	0.79	22,3	0.69
8S	1/2-14	24,9	0.98	22,4	0.88
12S	3/4-14	27,4	1.08	26,9	1.06
16S	1-11 1/2	32,3	1.27	44,4	1.31
20S	1 1/4-11 1/2	33,0	1.30	44,5	1.75
24S	1 1/2-11 1/2	33,8	1.33	50,8	2.00
32S	2-11 1/2	35,3	1.39	60,5	2.38

Note: Also available in stainless steel as part no. 259-2082

External pipe/plug countersunk hex

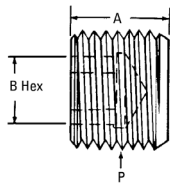

Part no. 2222-(Dash size) (Ref. SAE 140109N)

Dash size	Threads P1	A		B	
		mm	in	mm	in
2S	1/8-27	7,6	0.30	4,8	0.19
4S	1/4-18	11,7	0.46	6,4	0.25
6S	3/8-18	11,7	0.46	7,9	0.31
8S	1/2-14	15,5	0.61	9,7	0.38

External pipe/internal pipe

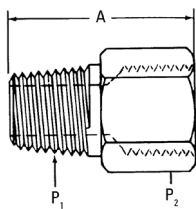

Part no. 2040-(Dash size) (Ref. SAE 140139)

Dash size	Threads P1	Threads P2	A	
			mm	in
2-2S	1/8-27	1/8-27	26,4	1.04
2-4S	1/8-27	1/4-18	30,7	1.21
2-8S	1/8-27	1/2-14	38,1	1.50
4-4S	1/4-18	1/4-18	35,3	1.39
4-6S	1/4-18	3/8-18	36,6	1.44
4-8S	1/4-18	1/2-14	42,7	1.68
4-12S	1/4-18	3/4-14	44,2	1.74
6-6S	3/8-18	3/8-18	36,6	1.44
6-8S	3/8-18	1/2-14	42,7	1.68
8-8S	1/2-14	1/2-14	47,5	1.87
8-12S	1/2-14	3/4-14	49,0	1.93
12-12S	3/4-14	3/4-14	49,0	1.93
12-16S	3/4-14	1-11 1/2	55,4	2.18
16-16S	1-11 1/2	1-11 1/2	60,2	2.37
16-20S	1-11 1/2	1 1/4-11 1/2	62,5	2.46
20-20S	1 1/4-11 1/2	1 1/4-11 1/2	63,2	2.49
20-24S	1 1/4-11 1/2	1 1/2-11 1/2	63,5	2.50
24-24S	1 1/2-11 1/2	1 1/2-11 1/2	64,3	2.53
32-32S	2-11 1/2	2-11 1/2	67,6	2.66

Pipe to pipe

Internal pipe swivel (NPSM)/external pipe

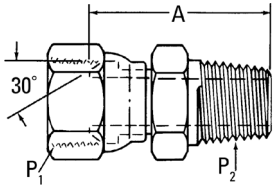

Part no. 2045-(Dash size) (Ref. SAE 140130)

Dash size	Threads P1	Threads P2	A	
			mm	in
2-2S	1/8-27	1/8-27	24,4	0.96
2-4S	1/8-27	1/4-18	29,0	1.14
4-4S	1/4-18	1/4-18	32,0	1.26
4-6S	1/4-18	3/8-18	32,0	1.26
4-8S	1/4-18	1/2-14	38,4	1.51
6-4S	3/8-18	1/4-18	32,0	1.26
6-6S	3/8-18	3/8-18	33,5	1.32
6-8S	3/8-18	1/2-14	40,1	1.58
8-6S	1/2-14	3/8-18	34,8	1.37
8-8S	1/2-14	1/2-14	41,1	1.62
8-12S	1/2-14	3/4-14	41,1	1.62
12-12S	3/4-14	3/4-14	44,5	1.75
12-16S	3/4-14	1-11 1/2	50,8	2.00
16-12S	1-11 1/2	3/4-14	44,7	1.76
16-16S	1-11 1/2	1-11 1/2	51,3	2.02
20-16S	1 1/4-11 1/2	1-11 1/2	53,3	2.10
20-20S	1 1/4-11 1/2	1 1/4-11 1/2	52,8	2.08
24-20S	1 1/2-11 1/2	1 1/4-11 1/2	55,1	2.17
24-24S	1 1/2-11 1/2	1 1/2-11 1/2	55,9	2.20
32-32S	2-11 1/2	2-11 1/2	60,7	2.39

Internal pipe swivel (NPSM)/external pipe

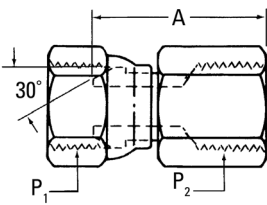

Part no. 2046-(Dash size) (Ref. SAE 140131)

Dash size	Threads P1	Threads P2	A	
			mm	in
2-2S	1/8-27	1/8-27	23,9	0.94
2-4S	1/8-27	1/4-18	26,9	1.06
4-2S	1/4-18	1/8-27	26,4	1.04
4-4S	1/4-18	1/4-18	33,0	1.30
4-6S	1/4-18	3/8-18	33,3	1.31
6-6S	3/8-18	3/8-18	33,8	1.33
6-8S	3/8-18	1/2-14	36,8	1.45
8-8S	1/2-14	1/2-14	39,6	1.56
12-12S	3/4-14	3/4-14	45,0	1.77
12-16S	3/4-14	1-11 1/2	51,8	2.04
16-16S	1-11 1/2	1-11 1/2	52,3	2.06
20-20S	1 1/4-11 1/2	1 1/4-11 1/2	52,3	2.06
24-24S	1 1/2-11 1/2	1 1/2-11 1/2	55,4	2.18
32-32S	2-11 1/2	2-11 1/2	58,4	2.30

Adapters and tube fittings

Pipe to Pipe

J

Pipe to pipe

Coupling – internal pipe/internal pipe

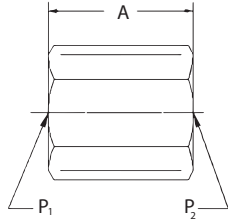

Part no. 2096-(Dash size) (Ref. SAE 140138)

Dash size	Threads P1	Thread P2	A	
			mm	in
2S	1/8-27	1/8-27	19,1	0.75
4S	1/4-18	1/4-18	28,7	1.13
6S	3/8-18	3/8-18	28,7	1.13
8S	1/2-14	1/2-14	38,1	1.50
12S	3/4-14	3/4-14	38,9	1.53
16S	1-11 1/2	1-11 1/2	48,0	1.89
20S	1 1/4-11 1/2	1 1/4-11 1/2	49,0	1.93
24S	1 1/2-11 1/2	1 1/2-11 1/2	49,0	1.93
32S	2-11 1/2	2-11 1/2	49,8	1.96

Note: Also available in stainless steel as part no. 259-2096

External pipe/external pipe

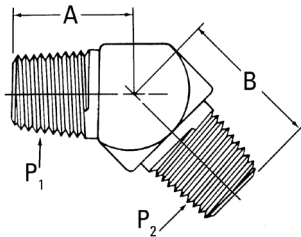

Part no. 2247-(Dash size) (Ref. SAE 140337)

Dash size	Threads P1	Thread P2	A		B	
			mm	in	mm	in
2-2S	1/8-27	1/8-27	17,0	0.67	17,0	0.67
4-4S	1/4-18	1/4-18	21,8	0.86	21,8	0.86
6-4S	3/8-18	1/4-18	24,1	0.95	24,1	0.95
6-6S	3/8-18	3/8-18	24,1	0.95	24,1	0.95
8-8S	1/2-14	1/2-14	28,7	1.13	29,7	1.17
12-12S	3/4-14	3/4-14	29,7	1.17	30,5	1.20
16-16S	1-11 1/2	1-11 1/2	30,5	1.20	37,6	1.48
20-20S	1 1/4-11 1/2	1 1/4-11 1/2	47,7	1.88	39,1	1.54

Internal pipe swivel (NPSM)/internal pipe

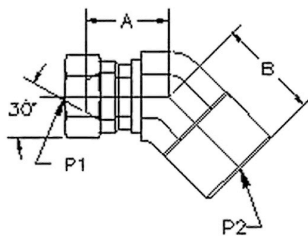

Part no. 2050-(Dash size) (Ref. SAE 140331)

Dash size	Threads P1	Thread P2	A		B	
			mm	in	mm	in
2-2S	1/8-27	1/8-27	15,7	0.62	12,7	0.50
4-4S	1/4-18	1/4-18	20,1	0.79	24,6	0.97
4-6S	1/4-18	3/8-18	23,4	0.92	30,0	1.18
6-6S	3/8-18	3/8-18	23,4	0.92	30,0	1.18
6-8S	3/8-18	1/2-14	21,8	0.86	35,8	1.41
8-8S	1/2-14	1/2-14	23,1	0.91	35,8	1.41
12-12S	3/4-14	3/4-14	27,9	1.10	38,9	1.53
16-16S	1-11 1/2	1-11 1/2	32,0	1.26	38,9	1.53
20-20S	1 1/4-11 1/2	1 1/4-11 1/2	31,2	1.23	36,6	1.44

Pipe to pipe

Internal pipe swivel (NPSM)/external pipe

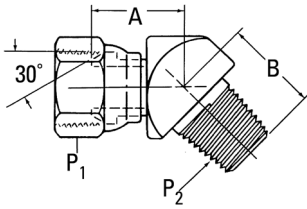

Part no. 2049-(Dash size) (Ref. SAE 140330)

Dash size	Threads P1	Thread P2	A		B	
			mm	in	mm	in
2-2S	1/8-27	1/8-27	17,0	0.67	17,8	0.70
4-2S	1/4-18	1/8-27	20,1	0.79	17,0	0.67
4-4S	1/4-18	1/4-18	20,1	0.79	24,6	0.97
4-6S	1/4-18	3/8-18	20,3	0.80	26,9	1.06
6-4S	3/8-18	1/4-18	23,4	0.92	25,4	1.00
6-6S	3/8-18	3/8-18	23,4	0.92	27,7	1.09
6-8S	3/8-18	1/2-14	23,4	0.92	35,8	1.41
8-6S	1/2-14	3/8-18	23,1	0.91	27,7	1.09
8-8S	1/2-14	1/2-14	23,1	0.91	35,8	1.41
8-12S	1/2-14	3/4-14	23,1	0.91	38,9	1.53
12-12S	3/4-14	3/4-14	27,9	1.10	38,9	1.53
12-16S	3/4-14	1-11 1/2	26,2	1.03	38,1	1.50
16-16S	1-11 1/2	1-11 1/2	32,0	1.26	38,9	1.53
16-20S	1-11 1/2	1 1/4-11 1/2	33,0	1.30	46,7	1.84
20-20S	1 1/4-11 1/2	1 1/4-11 1/2	36,8	1.45	46,7	1.84
24-24S	1 1/2-11 1/2	1 1/2-11 1/2	35,8	1.41	50,8	2.00

External pipe/internal pipe

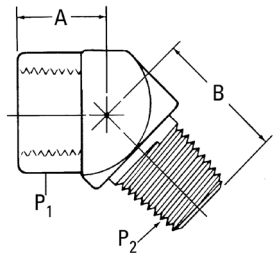

Part no. 2088-(Dash size) (Ref. SAE 140339)

Dash size	Threads P1	Thread P2	A		B	
			mm	in	mm	in
2-2S	1/8-27	1/8-27	11,9	0.47	18,3	0.72
4-4S	1/4-18	1/4-18	15,7	0.62	26,7	1.05
6-6S	3/8-18	3/8-18	18,3	0.72	26,9	1.06
8-8S	1/2-14	1/2-14	23,1	0.91	34,0	1.34
12-12S	3/4-14	3/4-14	24,6	0.97	35,1	1.38
16-16S	1-11 1/2	1-11 1/2	28,4	1.12	43,7	1.72

External pipe/internal pipe

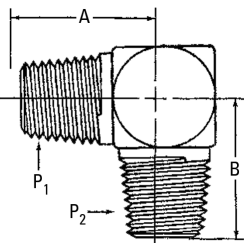

Part no. 2085-(Dash size) (Ref. SAE 140237)

Dash size	Threads P1	Thread P2	A		B	
			mm	in	mm	in
2-2S	1/8-27	1/8-27	19,8	0.78	19,8	0.78
4-4S	1/4-18	1/4-18	27,7	1.09	27,7	1.09
6-4S	3/8-18	1/4-18	31,0	1.22	31,0	1.22
6-6S	3/8-18	3/8-18	31,0	1.22	31,0	1.22
8-6S	1/2-14	3/8-18	37,3	1.47	32,5	1.28
8-8S	1/2-14	1/2-14	37,3	1.47	37,3	1.47
12-8S	3/4-14	1/2-14	40,4	1.59	40,4	1.59
12-12S	3/4-14	3/4-14	40,4	1.59	40,4	1.59
16-12S	1-11 1/2	3/4-14	50,0	1.97	45,2	1.78
16-16S	1-11 1/2	1-11 1/2	50,0	1.97	50,0	1.97

Adapters and tube fittings

Pipe to Pipe

J

Pipe to Pipe

External pipe/hose Connector

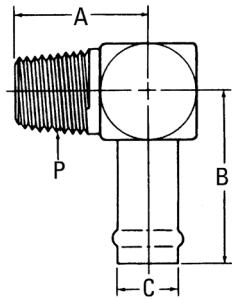

Part no. FF1162-(Dash size) (Ref. SAE 430260)

Dash size	Tube O.D.		Threads T1	A		B		C	
	mm	in		mm	in	mm	in	mm	in
0406S	9,7	0.38	1/4-18	27,7	1.09	39,1	1.54	9,7	0.38
1212S	19,0	0.75	3/4-14	35,8	1.41	46,5	1.83	19,0	0.75
1616S	25,4	1.00	1-11 1/2	50,0	1.97	49,3	1.94	25,4	1.00

Note: Clamp required.

External pipe swivel/external pipe

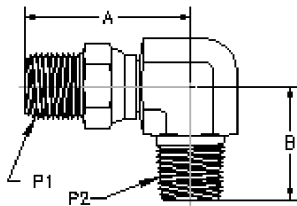

Part no. 2251-(Dash size)

Dash size	Threads P1	Thread P2	A		B	
			mm	in	mm	in
4-4S	1/4-18	1/4-18	43,7	1.72	27,7	1.09
6-6S	3/8-18	3/8-18	45,2	1.78	31,0	1.22
8-8S	1/2-14	1/2-14	54,4	2.14	37,3	1.47
12-12S	3/4-14	3/4-14	66,3	2.61	40,4	1.59

Note: The above adapter is not a rotating union or swivel joint. Care must be exercised to avoid misuse. To be used with petroleum or water glycol fluids.

External pipe/internal pipe

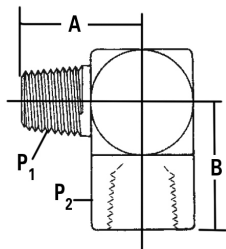

Part no. 2089-(Dash size) (Ref. SAE 140239)

Dash size	Threads P1	Thread P2	A		B	
			mm	in	mm	in
2-2S	1/8-27	1/8-27	19,8	0.78	16,8	0.66
2-4S	1/8-27	1/4-18	22,9	0.90	22,4	0.88
4-2S	1/4-18	1/8-27	27,7	1.09	17,0	0.67
4-4S	1/4-18	1/4-18	27,7	1.09	22,4	0.88
4-6S	1/4-18	3/8-18	31,0	1.22	25,9	1.02
6-4S	3/8-18	1/4-18	31,0	1.22	25,7	1.01
6-6S	3/8-18	3/8-18	31,0	1.22	25,9	1.02
6-8S	3/8-18	1/2-14	32,5	1.28	31,2	1.23
8-6S	1/2-14	3/8-18	37,3	1.47	25,7	1.01
8-8S	1/2-14	1/2-14	37,3	1.47	31,2	1.23
8-12S	1/2-14	3/4-14	40,4	1.59	34,5	1.36
12-8S	3/4-14	1/2-14	40,4	1.59	34,3	1.35
12-12S	3/4-14	3/4-14	40,4	1.59	34,5	1.36
16-16S	1-11 1/2	1-11 1/2	50,0	1.97	41,1	1.62
20-20S	1 1/4-11 1/2	1 1/4-11 1/2	60,5	2.38	43,2	1.70
24-24S	1 1/2-11 1/2	1 1/2-11 1/2	67,1	2.64	52,8	2.08

Pipe to Pipe

External pipe swivel/internal pipe

Part no. 2252-(Dash size)

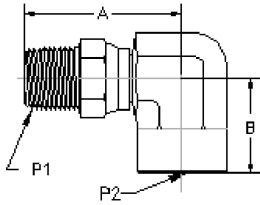

Dash size	Threads P1	Thread P2	A		B	
			mm	in	mm	in
2-2S	1/8-27	1/8-27	35,1	1.38	17,3	0.68
4-4S	1/4-18	1/4-18	43,7	1.72	22,4	0.88
6-6S	3/8-18	3/8-18	45,2	1.78	25,9	1.02
8-8S	1/2-14	1/2-14	54,4	2.14	31,2	1.23
12-12S	3/4-14	3/4-14	66,3	2.61	40,4	1.59

Note: The above adapter is not a rotating union or swivel joint. Care must be exercised to avoid misuse. To be used with petroleum or water glycol fluids.

Internal pipe swivel (NPSM)/internal pipe

Part no. 2048-(Dash size) (Ref. SAE 140231)

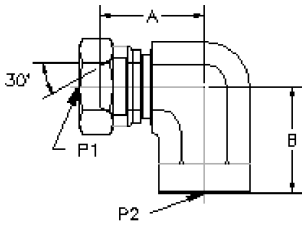

Dash size	Threads P1	Thread P2	A		B	
			mm	in	mm	in
2-2S	1/8-27	1/8-27	19,8	0.78	16,8	0.66
4-4S	1/4-18	1/4-18	23,1	0.91	24,6	1.0
4-6S	1/4-18	3/8-18	25,4	1.00	27,7	1.09
6-4S	3/8-18	1/4-18	24,6	0.97	24,6	0.97
6-6S	3/8-18	3/8-18	27,7	1.09	27,7	1.09
6-8S	3/8-18	1/2-14	27,9	1.10	34,0	1.34
8-6S	1/2-14	3/8-18	27,4	1.08	34,0	1.34
8-8S	1/2-14	1/2-14	27,4	1.08	34,0	1.34
12-12S	3/4-14	3/4-14	34,5	1.36	38,9	1.53
16-16S	1-11 1/2	1-11 1/2	39,6	1.56	45,2	1.78
20-20S	1 1/4-11 1/2	1 1/4-11 1/2	46,2	1.82	51,6	2.03
24-24S	1 1/2-11 1/2	1 1/2-11 1/2	51,3	2.02	57,9	2.28

Adapters and tube fittings

Pipe to Pipe

J

Pipe to pipe

Internal pipe swivel (NPSM)/external pipe

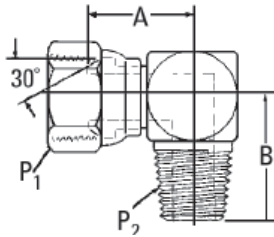

Part no. 2047-(Dash size) (Ref. SAE 140230)

Dash size	Threads P1	Thread P2	A		B	
			mm	in	mm	in
2-2S	1/8-27	1/8-27	18,0	0.71	26,2	1.03
4-4S	1/4-18	1/4-18	23,1	0.91	32,5	1.28
4-6S	1/4-18	3/8-18	27,7	1.09	38,9	1.53
4-8S	1/4-18	1/2-14	26,2	1.03	46,7	1.84
6-4S	3/8-18	1/4-18	25,1	0.99	31,0	1.22
6-6S	3/8-18	3/8-18	27,7	1.09	38,9	1.53
6-8S	3/8-18	1/2-14	26,2	1.03	46,7	1.84
8-6S	1/2-14	3/8-18	27,4	1.08	41,9	1.65
8-8S	1/2-14	1/2-14	27,4	1.08	46,7	1.84
8-12S	1/2-14	3/4-14	31,5	1.24	51,6	2.03
12-8S	3/4-14	1/2-14	34,5	1.36	51,6	2.03
12-12S	3/4-14	3/4-14	34,5	1.36	51,6	2.03
12-16S	3/4-14	1-11 1/2	38,4	1.51	61,2	2.41
16-12S	1-11 1/2	3/4-14	38,9	1.53	56,4	2.22
16-16S	1-11 1/2	1-11 1/2	38,9	1.53	61,2	2.41
20-20S	1 1/4-11 1/2	1 1/4-11 1/2	46,2	1.82	67,3	2.65
24-24S	1 1/2-11 1/2	1 1/2-11 1/2	51,3	2.02	72,1	2.84
32-32S	2-11 1/2	2-11 1/2	60,2	2.37	84,8	3.34

Internal pipe/internal pipe

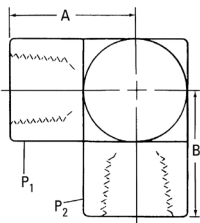

Part no. 2087-(Dash size) (Ref. SAE 140238)

Dash size	Threads P1	Thread P2	A		B	
			mm	in	mm	in
2-2S	1/8-27	1/8-27	16,8	0.66	16,8	0.66
4-2S	1/4-18	1/8-27	22,4	0.88	17,0	0.67
4-4S	1/4-18	1/4-18	22,4	0.88	22,4	0.88
6-4S	3/8-18	1/4-18	25,9	1.02	25,7	1.01
6-6S	3/8-18	3/8-18	25,9	1.02	25,9	1.02
8-6S	1/2-14	3/8-18	31,2	1.23	25,7	1.01
8-8S	1/2-14	1/2-14	31,2	1.23	31,2	1.23
12-8S	3/4-14	1/2-14	34,5	1.36	34,3	1.35
12-12S	3/4-14	3/4-14	34,5	1.36	34,5	1.36
16-12S	1-11 1/2	3/4-14	41,1	1.62	35,3	1.39
16-16S	1-11 1/2	1-11 1/2	41,1	1.62	41,1	1.62
20-20S	1 1/4-11 1/2	1 1/4-11 1/2	43,2	1.70	43,2	1.70
24-24S	1 1/2-11 1/2	1 1/2-11 1/2	52,8	2.08	52,8	2.08

Pipe to pipe

External pipe/external pipe

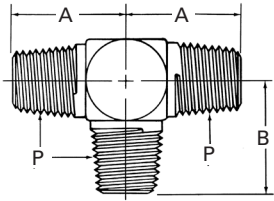

Part no. 2257-(Dash size)

Dash size	Threads P1	A		B	
		mm	in	mm	in
2-2S	1/8-27	19,8	0.78	19,8	0.78
4-4S	1/4-18	27,7	1.09	27,7	1.09
6-6S	3/8-18	31,0	1.22	31,0	1.22
8-8S	1/2-14	37,3	1.47	37,3	1.47
12-12S	3/4-14	40,4	1.59	40,4	1.59

External pipe/internal pipe

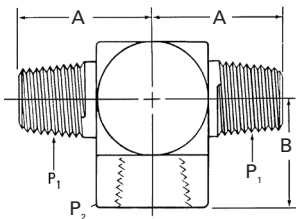

Part no. 2256-(Dash size)

Dash size	Threads P1	Thread P2	A		B	
			mm	in	mm	in
2-2S	1/8-27	1/8-27	19,8	0.78	16,8	0.66
4-4S	1/4-18	1/4-18	27,7	1.09	22,3	0.88
6-6S	3/8-18	3/8-18	31,0	1.22	25,9	1.02
8-8S	1/2-14	1/2-14	37,3	1.47	31,2	1.23
12-12S	3/4-14	3/4-14	40,4	1.59	34,5	1.36

External pipe/internal pipe

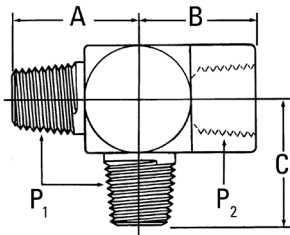

Part no. 2093-(Dash size)

Dash size	Threads P1	Thread P2	A		B		C	
			mm	in	mm	in	mm	in
2-2S	1/8-27	1/8-27	19,8	0.78	16,8	0.66	19,8	0.78
4-4S	1/4-18	1/4-18	27,7	1.09	22,3	0.88	27,7	1.09
6-6S	3/8-18	3/8-18	31,0	1.22	25,9	1.02	31,0	1.22
8-8S	1/2-14	1/2-14	37,3	1.47	31,2	1.23	37,3	1.47
12-12S	3/4-14	3/4-14	40,4	1.59	34,5	1.36	40,4	1.59
16-16S	1-11 1/2	1-11 1/2	50,0	1.97	41,1	1.62	50,0	1.97

External pipe/Internal pipe

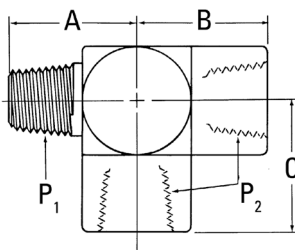

Part no. 2092-(Dash size) (Ref. SAE 140424)

Dash size	Threads P1	Thread P2	A		B		C	
			mm	in	mm	in	mm	in
2-2S	1/8-27	1/8-27	19,8	0.78	16,8	0.66	16,8	0.66
4-4S	1/4-18	1/4-18	27,7	1.09	22,4	0.88	22,4	0.88
6-6S	3/8-18	3/8-18	31,0	1.22	25,9	1.02	25,9	1.02
8-8S	1/2-14	1/2-14	37,3	1.47	31,2	1.23	31,2	1.23
12-8S	3/4-14	1/2-14	40,4	1.59	34,3	1.35	34,3	1.35
12-12S	3/4-14	3/4-14	40,4	1.59	34,5	1.36	34,5	1.36
16-16S	1-11 1/2	1-11 1/2	50,0	1.97	41,1	1.62	41,1	1.62
20-20S	1 1/4-11 1/2	1 1/4-11 1/2	60,5	2.38	43,2	1.70	43,2	1.70
24-24S	1 1/2-11 1/2	1 1/2-11 1/2	67,1	2.64	52,8	2.08	52,8	2.08

Adapters and tube fittings

Pipe to Pipe

J

Pipe to pipe

Internal pipe swivel (NPSM)/external pipe

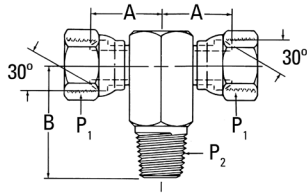

Part no. 2254-(Dash size)

Dash size	Threads P1	Thread P2	A		B	
			mm	in	mm	in
2-2S	1/8-27	1/8-27	17,8	0.7	18,3	0.72
4-4S	1/4-18	1/4-18	22,4	0.88	27,7	1.09
6-6S	3/8-18	3/8-18	27,7	1.09	38,9	1.53
6-8S	3/8-18	1/2-14	27,7	1.09	37,3	1.47
8-8S	1/2-14	1/2-14	27,9	1.10	37,3	1.47
12-12S	3/4-14	3/4-14	34,5	1.36	51,6	2.03

Internal pipe swivel (NPSM)

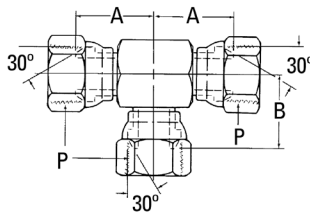

Part no. 2255-(Dash size)

Dash size	Threads P1	A		B	
		mm	in	mm	in
2-2S	1/8-27	18,0	0.71	18,0	0.71
4-4S	1/4-18	23,1	0.91	23,1	0.91
6-6S	3/8-18	25,1	0.99	25,1	0.99
8-8S	1/2-14	27,4	1.08	27,4	1.08
12-12S	3/4-14	34,5	1.36	34,5	1.36

Internal pipe swivel (NPSM)/internal pipe

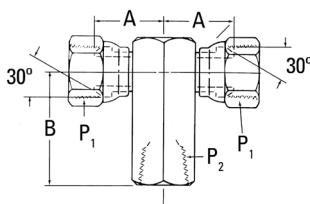

Part no. 2253-(Dash size)

Dash size	Threads P1	Thread P2	A		B	
			mm	in	mm	in
6-6S	3/8-18	3/8-18	26,9	1.06	25,9	1.02
8-8S	1/2-14	1/2-14	31,5	1.24	31,2	1.23
12-12S	3/4-14	3/4-14	36,5	1.44	34,5	1.36

External pipe/internal pipe

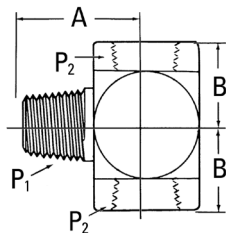

Part no. 2091-(Dash size) (Ref. SAE 140425)

Dash size	Threads P1	Thread P2	A		B	
			mm	in	mm	in
2-2S	1/8-27	1/8-27	19,8	0.78	16,8	0.66
4-4S	1/4-18	1/4-18	27,7	1.09	22,4	0.88
6-6S	3/8-18	3/8-18	31,0	1.22	25,9	1.02
8-8S	1/2-14	1/2-14	37,3	1.47	31,2	1.23
12-12S	3/4-14	3/4-14	40,4	1.59	34,5	1.36
16-16S	1-11 1/2	1-11 1/2	50,0	1.97	41,1	1.62

Pipe to pipe

Internal pipe/internal pipe

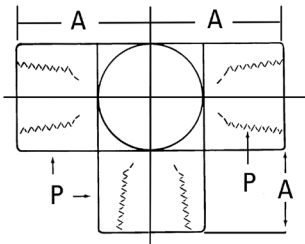

Part no. 2090-(Dash size)

(Ref. SAE 140438)

Dash size	Threads P1	A	
		mm	in
2-2S	1/8-27	16,8	0.66
4-4S	1/4-18	22,4	0.88
6-6S	3/8-18	25,9	1.02
8-8S	1/2-14	31,2	1.23
12-12S	3/4-14	34,5	1.36
16-16S	1-11 1/2	41,1	1.62
20-20S	1 1/4-11 1/2	43,2	1.70
24-24S	1 1/2-11 1/2	52,8	2.08

Internal pipe/internal pipe

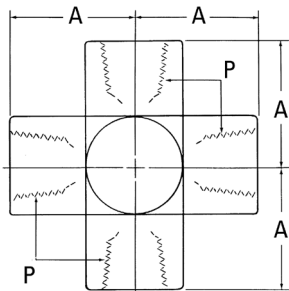

Part no. 2080-(Dash size)

Dash size	Threads P1	A	
		mm	in
2-2S	1/8-27	16,8	0.66
4-4S	1/4-18	22,3	0.88
6-6S	3/8-18	25,9	1.02
8-8S	1/2-14	31,2	1.23
12-12S	3/4-14	34,5	1.36
16-16S	1-11 1/2	41,1	1.62

Adapters and tube fittings

Pipe to 37° flare

J

Pipe to 37° flare

External pipe/37° flare

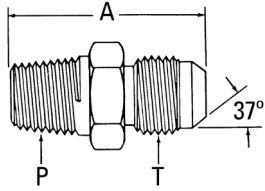

Part no. 2021-(Dash size) (Ref. SAE 070102)

Dash size	Tube O. D.		Thread P	Thread T	A	
	mm	in			mm	in
2-2S	3,3	0.13	1/8-27	5/16-24	28,2	1.11
2-3S	4,8	0.19	1/8-27	3/8-24	29,0	1.14
2-4S	6,3	0.25	1/8-27	7/16-20	31,0	1.22
2-5S	7,9	0.31	1/8-27	1/2-20	31,0	1.22
2-6S	9,6	0.38	1/8-27	9/16-18	31,5	1.24
2-8S	12,7	0.50	1/8-27	3/4-16	34,0	1.34
4-4S	6,3	0.25	1/4-18	7/16-20	36,1	1.42
4-5S	7,9	0.31	1/4-18	1/2-20	36,1	1.42
4-6S	9,6	0.38	1/4-18	9/16-18	36,3	1.43
4-8S	12,7	0.50	1/4-18	3/4-16	38,9	1.53
6-4S	6,3	0.25	3/8-18	7/16-20	36,1	1.42
6-5S	7,9	0.31	3/8-18	1/2-20	36,1	1.42
6-6S	9,6	0.38	3/8-18	9/16-18	36,3	1.43
6-8S	12,7	0.50	3/8-18	3/4-16	38,9	1.53
6-10S	16,0	0.63	3/8-18	7/8-14	43,2	1.70
6-12S	19,0	0.75	3/8-18	1 1/16-12	44,5	1.75
8-4S	6,3	0.25	1/2-14	7/16-20	42,7	1.68
8-6S	9,6	0.38	1/2-14	9/16-18	42,9	1.69
8-8S	12,7	0.50	1/2-14	3/4-16	45,5	1.79
8-10S	16,0	0.63	1/2-14	7/8-14	48,0	1.89
8-12S	19,0	0.75	1/2-14	11/16-12	52,3	2.06
8-16S	25,4	1.00	1/2-14	1 5/16-12	53,6	2.11
12-6S	9,6	0.38	3/4-14	9/16-18	44,5	1.75
12-8S	12,7	0.50	3/4-14	3/4-16	47,0	1.85
12-10S	16,0	0.63	3/4-14	7/8-14	49,5	1.95
12-12S	19,0	0.75	3/4-14	11/16-12	52,3	2.06
12-14S	22,3	0.88	3/4-14	1 3/16-12	53,1	2.09
12-16S	25,4	1.00	3/4-14	1 5/16-12	53,6	2.11
16-10S	16,0	0.63	1-11 1/2	7/8-14	54,6	2.15
16-12S	19,0	0.75	1-11 1/2	1 1/16-12	57,2	2.25
16-16S	25,4	1.00	1-11 1/2	1 5/16-12	58,4	2.30
16-20S	31,7	1.25	1-11 1/2	1 5/8-12	61,5	2.42
16-24S	38,1	1.50	1-11 1/2	1 7/8-12	66,5	2.62
16-32S	50,8	2.00	1-11 1/2	2 1/2-12	76,7	3.02
20-12S	19,0	0.75	1 1/4-11 1/2	1 1/16-12	59,9	2.36
20-16S	25,4	1.00	1 1/4-11 1/2	1 5/16-12	61,0	2.40
20-20S	31,7	1.25	1 1/4-11 1/2	1 5/8-12	62,2	2.45
20-24S	38,1	1.50	1 1/4-11 1/2	1 7/8-12	67,3	2.65
20-32S	50,8	2.00	1 1/4-11 1/2	2 1/2-12	77,5	3.05
24-12S	19,0	0.75	1 1/2-11 1/2	1 1/16-12	62,5	2.46
24-16S	25,4	1.00	1 1/2-11 1/2	1 5/16-12	63,8	2.51
24-20S	31,7	1.25	1 1/2-11 1/2	1 5/8-12	64,8	2.55
24-24S	38,1	1.50	1 1/2-11 1/2	1 7/8-12	68,1	2.68
24-32S	50,8	2.00	1 1/2-11 1/2	2 1/2-12	78,2	3.08
32-32S	50,8	2.00	2-11 1/2	2 1/2-12	79,0	3.11
40-40S	63,5	2.50	2 1/2-8	3-12	85,9	3.38

Note: Also available in stainless steel as Part no. 259-2021.

Pipe to 37° flare

External pipe/37° flare bulkhead

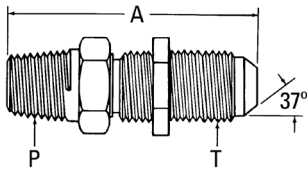

Part no. 2240-(Dash size)

Dash size	Tube O. D.		Thread P	Thread T	A	
	mm	in			mm	in
2-4S	6,3	0.25	1/8-27	7/16-20	46,7	1.84
4-4S	6,3	0.25	1/4-18	7/16-20	51,6	2.03
4-6S	9,6	0.38	1/4-18	9/16-18	53,8	2.12
6-8S	12,7	0.50	3/8-18	3/4-16	59,9	2.36
8-10S	16,0	0.63	1/2-14	7/8-14	68,8	2.71
12-12S	19,0	0.75	3/4-14	1 1/16-12	74,2	2.92
16-16S	25,4	1.00	1-11 1/2	1 5/16-12	79,0	3.11

Note: Also available in stainless steel as Part no. 259-2240.

External pipe/37° flare

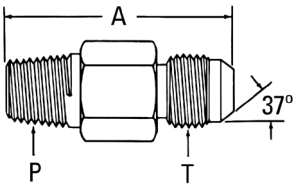

Part no. 202113-(Dash size)

Dash size	Tube O. D.		Thread P	Thread T	A	
	mm	in			mm	in
2-4S	6,3	0.25	1/8-27	7/16-20	46,0	1.81
2-5S	7,9	0.31	1/8-27	1/2-20	49,3	1.94
4-4S	6,3	0.25	1/4-18	7/16-20	57,2	2.25
4-5S	7,9	0.31	1/4-18	1/2-20	57,2	2.25
4-6S	9,6	0.38	1/4-18	9/16-18	57,2	2.25
6-6S	9,6	0.38	3/8-18	9/16-18	63,5	2.50
6-8S	12,7	0.50	3/8-18	3/4-16	69,8	2.75
8-10S	16,0	0.63	1/2-14	7/8-14	79,2	3.12
8-12S	19,0	0.75	1/2-14	11/16-12	83,3	3.28
12-12S	19,0	0.75	3/4-14	11/16-12	88,9	3.50
16-16S	25,4	1.00	1-11 1/2	15/16-12	101,6	4.00
20-20S	38,1	1.50	1 1/4-11 1/2	1 5/8-12	114,3	4.50
24-24S	38,1	1.50	1 1/2-11 1/2	1 7/8-12	123,9	4.88
32-32S	50,8	2.00	2-11 1/2	2 1/2-12	142,7	5.62

External pipe/37° flare

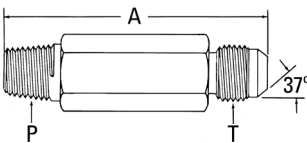

Part no. 202114-(Dash size)

Dash size	Tube O. D.		Thread P	Thread T	A	
	mm	in			mm	in
2-4S	6,3	0.25	1/8-27	7/16-20	65,0	2.56
2-5S	7,9	0.31	1/8-27	1/2-20	71,4	2.81
4-4S	6,3	0.25	1/4-18	7/16-20	82,5	3.25
4-5S	7,9	0.31	1/4-18	1/2-20	82,5	3.25
4-6S	9,6	0.38	1/4-18	9/16-18	82,5	3.25
6-8S	12,7	0.50	3/8-18	3/4-16	101,6	4.00
8-6S	9,6	0.38	1/2-14	9/16-18	105,9	4.17
8-10S	16,0	0.63	1/2-14	7/8-14	111,2	4.38
12-12S	19,0	0.75	3/4-14	1 1/16-12	127,0	5.00
12-16S	25,4	1.00	3/4-14	1 5/16-12	141,2	5.56
16-16S	25,4	1.00	1-11 1/2	1 5/16-12	146,0	5.75

Adapters and tube fittings

Pipe to 37° flare

J

Pipe to 37° flare

Internal pipe/37° flare bulkhead

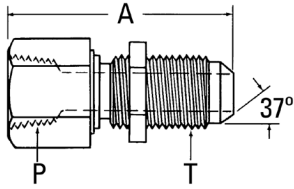

Part no. 2239-(Dash size) (Ref. SAE 070603)

Dash size	Tube O. D.		Thread P	Thread T	A	
	mm	in			mm	in
2-4S	6,3	0.25	1/8-27	7/16-20	52,8	2.08
6-8S	12,7	0.50	3/8-18	3/4-16	63,0	2.48
8-10S	16,0	0.63	1/2-14	7/8-14	72,1	2.84
12-12S	19,0	0.75	3/4-14	1 1/16-12	77,5	3.05
16-16S	25,4	1.00	1-11 1/2	1 5/16-12	82,5	3.25

External pipe/37° flare swivel

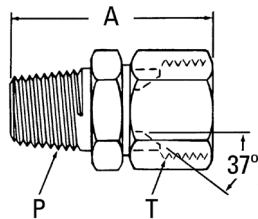

Part no. 2018-(Dash size)

Dash size	Tube O. D.		Thread P	Thread T	A	
	mm	in			mm	in
2-4S	6,3	0.25	1/8-27	7/16-20	33,6	1.32
4-4S	6,3	0.25	1/4-18	7/16-20	38,1	1.50
4-6S	9,6	0.38	1/4-18	9/16-18	40,4	1.59
6-6S	9,6	0.38	3/8-18	9/16-18	40,4	1.59
6-8S	12,7	0.50	3/8-18	3/4-16	44,2	1.74
6-10S	16,0	0.63	3/8-18	7/8-14	48,8	1.92
8-8S	12,7	0.50	1/2-14	3/4-16	49,0	1.93
12-12S	19,0	0.75	3/4-14	1 1/16-12	54,6	2.15
16-16S	25,4	1.00	1-11 1/2	1 5/16-12	64,5	2.54
20-20S	31,7	1.25	1 1/4-11 1/2	1 5/8-12	70,6	2.78

Internal pipe/37° flare swivel

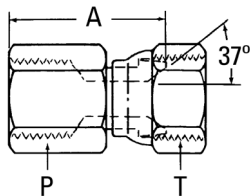

Part no. 2242-(Dash size) (Ref. SAE 070603)

Dash size	Tube O. D.		Thread P	Thread T	A	
	mm	in			mm	in
2-4S	6,3	0.25	1/8-27	7/16-20	21,6	0.85
2-5S	7,9	0.31	1/8-27	1/2-20	22,1	0.87
4-4S	6,3	0.25	1/4-18	7/16-20	28,2	1.11
4-5S	7,9	0.31	1/4-18	1/2-20	27,9	1.10
4-6S	9,6	0.38	1/4-18	9/16-18	30,0	1.18
6-6S	9,6	0.38	3/8-18	9/16-18	29,5	1.16
6-8S	12,7	0.50	3/8-18	3/4-16	30,5	1.20
8-6S	9,6	0.38	1/2-14	9/16-18	36,1	1.42
8-8S	12,7	0.50	1/2-14	3/4-16	37,6	1.48
8-10S	16,0	0.63	1/2-14	7/8-14	37,3	1.47
8-12S	19,0	0.75	1/2-14	1 1/16-12	36,8	1.45
12-12S	19,0	0.75	3/4-14	1 1/16-12	37,8	1.49
12-14S	22,3	0.88	3/4-14	1 3/16-12	39,4	1.55
16-16S	25,4	1.00	1-11 1/2	1 5/16-12	47,0	1.85
20-20S	31,7	1.25	1 1/4-11 1/2	1 5/8-12	51,3	2.02

Pipe to 37° flare

Internal pipe/37° flare

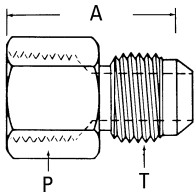

Part no. 2022-(Dash size) (Ref. SAE 070103)

Dash size	Tube O. D.		Thread P	Thread T	A	
	mm	in			mm	in
2-2S	4,8	0.13	1/8-27	5/16-24	28,4	1.12
2-3S	4,8	0.19	1/8-27	3/8-24	28,7	1.13
2-4S	6,4	0.25	1/8-27	7/16-20	30,2	1.19
2-5S	7,9	0.31	1/8-27	1/2-20	29,7	1.17
4-3S	4,8	0.19	1/4-18	3/8-24	33,5	1.32
4-4S	6,4	0.25	1/4-18	7/16-20	35,3	1.39
4-5S	7,9	0.31	1/4-18	1/2-20	35,3	1.39
4-6S	9,7	0.38	1/4-18	9/16-18	35,6	1.40
4-8S	12,7	0.50	1/4-18	3/4-16	39,4	1.55
6-6S	9,7	0.38	3/8-18	9/16-18	37,1	1.46
6-8S	12,7	0.50	3/8-18	3/4-16	39,6	1.56
8-4S	6,4	0.25	1/2-14	7/16-20	42,7	1.68
8-6S	9,7	0.38	1/2-14	9/16-18	42,9	1.69
8-8S	12,7	0.50	1/2-14	3/4-16	45,5	1.79
8-10S	16,0	0.63	1/2-14	7/8-14	48,0	1.89
8-12S	19,1	0.75	1/2-14	1 1/16-12	52,1	2.05
12-8S	12,7	0.50	3/4-14	3/4-16	47,0	1.85
12-10S	16,0	0.63	3/4-14	7/8-14	49,5	1.95
12-12S	19,1	0.75	3/4-14	1 1/16-12	52,3	2.06
12-16S	25,4	1.00	3/4-14	1 5/16-12	53,8	2.12
16-12S	19,1	0.75	1-11 1/2	1 1/16-12	58,4	2.30
16-16S	25,4	1.00	1-11 1/2	1 5/16-12	59,7	2.35
20-16S	25,4	1.00	1 1/4-11 1/2	1 5/16-12	62,0	2.44
20-20S	31,8	1.25	1 1/4-11 1/2	1 5/8-12	63,2	2.49
24-24S	38,1	1.50	1 1/2-11 1/2	1 7/8-12	66,5	2.62
32-32S	50,8	2.00	2-11 1/2	2-11 1/2	75,4	2.97

Internal pipe/37° flare

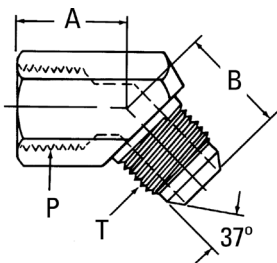

Part no. 2044-(Dash size)

Dash size	Tube O. D.		Thread P	Thread T	A		B	
	mm	in			mm	in	mm	in
4-6S	9,6	0.38	1/4-18	9/16-18	15,7	0.62	21,0	0.83
6-8S	12,7	0.50	3/8-18	3/4-16	18,3	0.72	24,9	0.98
8-10S	16,0	0.63	1/2-14	7/8-14	23,1	0.91	28,2	1.11
12-12S	19,0	0.75	3/4-14	1 1/16-12	24,6	0.97	34,3	1.35

Adapters and tube fittings

Pipe to 37° flare

J

Pipe to 37° flare

External pipe/37° flare

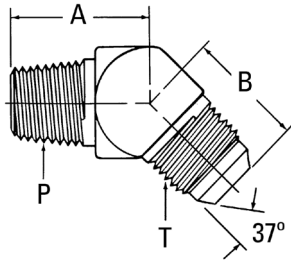

Part no. 2023-(Dash size) (Ref. SAE 070302)

Dash size	Tube O. D.		Thread P	Thread T	A		B	
	mm	in			mm	in	mm	in
2-3S	4,8	0.19	1/8-27	3/8--24	18,3	0.72	21,1	0.83
2-4S	6,3	0.25	1/8-27	7/16-20	16,3	0.64	18,3	0.72
2-5S	7,9	0.31	1/8-27	1/2-20	16,3	0.64	19,6	0.77
2-6S	9,6	0.38	1/8-27	9/16-18	17,0	0.67	21,1	0.83
4-4S	6,3	0.25	1/4-18	7/16-20	21,8	0.86	20,8	0.82
4-5S	7,9	0.31	1/4-18	1/2-20	21,8	0.86	20,8	0.82
4-6S	9,6	0.38	1/4-18	9/16-18	21,8	0.86	21,1	0.83
4-8S	12,7	0.50	1/4-18	3/4-16	24,1	0.95	24,9	0.98
6-4S	6,3	0.25	3/8-18	7/16-20	24,1	0.95	21,6	0.85
6-6S	9,6	0.38	3/8-18	9/16-18	24,1	0.95	22,1	0.87
6-8S	12,7	0.50	3/8-18	3/4-16	24,1	0.95	24,9	0.98
6-10S	16,0	0.63	3/8-18	7/8-14	24,9	0.98	28,2	1.11
6-12S	19,0	0.75	3/8-18	1 1/16-12	25,7	1.01	32,5	1.28
8-6S	9,6	0.38	1/2-14	9/16-18	29,7	1.17	22,4	0.88
8-8S	12,7	0.50	1/2-14	3/4-16	29,7	1.17	25,1	0.99
8-10S	16,0	0.63	1/2-14	7/8-14	29,7	1.17	28,2	1.11
8-12S	19,0	0.75	1/2-14	1 1/16-12	30,5	1.20	32,5	1.28
12-8S	12,7	0.50	3/4-14	3/4-16	30,5	1.20	26,4	1.04
12-10S	16,0	0.63	3/4-14	7/8-14	30,5	1.20	29,5	1.16
12-12S	19,0	0.75	3/4-14	1 1/16-12	30,5	1.20	32,5	1.28
12-16S	25,4	1.00	3/4-14	1 5/16-12	32,8	1.29	37,3	1.47
16-12S	19,0	0.75	1-11 1/2	1 1/16-12	37,6	1.48	36,1	1.42
16-16S	25,4	1.00	1-11 1/2	1 5/16-12	37,6	1.48	37,3	1.47
16-20S	31,7	1.25	1-11 1/2	1 5/8-12	41,7	1.64	40,4	1.59
20-20S	31,7	1.25	1 1/4-11 1/2	1 5/8-12	42,4	1.67	40,4	1.59
24-24S	38,1	1.50	1 1/2-11 1/2	1 7/8-12	45,0	1.77	45,2	1.78
32-32S	50,8	2.00	2-11 1/2	2 1/2-12	53,6	2.11	56,4	2.22

Internal pipe/37° flare swivel

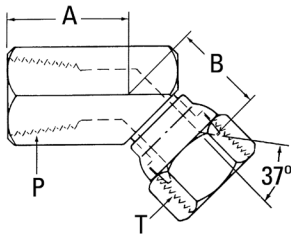

Part no. 2243-(Dash size)

Dash size	Tube O. D.		Thread P	Thread T	A		B	
	mm	in			mm	in	mm	in
8-6S	9,6	0.38	1/2-14	9/16-18	23,1	0.91	21,3	0.84
8-10S	16,0	0.63	1/2-14	7/8-14	23,1	0.91	23,9	0.94

Pipe to 37° flare

External pipe/37° flare

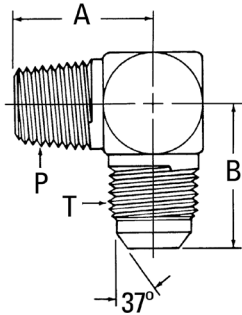

Part no. 2024-(Dash size) (Ref. SAE 070202)

Dash size	Tube O. D.		Thread P	Thread T	A		B	
	mm	in			mm	in	mm	in
2-3S	4,8	0.19	1/8-27	3/8-24	18,3	0.72	21,1	0.83
2-4S	6,3	0.25	1/8-27	7/16-20	19,8	0.78	22,6	0.89
2-5S	7,9	0.31	1/8-27	1/2-20	19,8	0.78	24,1	0.95
2-6S	9,6	0.38	1/8-27	9/16-18	22,9	0.90	26,9	1.06
4-4S	6,3	0.25	1/4-18	7/16-20	27,7	1.09	26,7	1.05
4-5S	7,9	0.31	1/4-18	1/2-20	27,7	1.09	26,7	1.05
4-6S	9,6	0.38	1/4-18	9/16-18	27,7	1.09	26,9	1.06
4-8S	12,7	0.50	1/4-18	3/4-16	31,0	1.22	31,8	1.25
6-4S	6,3	0.25	3/8-18	7/16-20	31,0	1.22	28,4	1.12
6-5S	7,9	0.31	3/8-18	1/2-20	31,0	1.22	28,4	1.12
6-6S	9,6	0.38	3/8-18	9/16-18	31,0	1.22	29,0	1.14
6-8S	12,7	0.50	3/8-18	3/4-16	31,0	1.22	31,8	1.25
6-10S	16,0	0.63	3/8-18	7/8-14	32,5	1.28	36,8	1.45
6-12S	19,0	0.75	3/8-18	1 1/16-12	35,6	1.40	42,2	1.66
8-4S	6,3	0.25	1/2-14	7/16-20	37,3	1.47	30,7	1.21
8-6S	9,6	0.38	1/2-14	9/16-18	37,3	1.47	31,0	1.22
8-8S	12,7	0.50	1/2-14	3/4-16	37,3	1.47	33,8	1.33
8-10S	16,0	0.63	1/2-14	7/8-14	37,3	1.47	36,8	1.45
8-12S	19,0	0.75	1/2-14	1 1/16-12	40,4	1.59	42,2	1.66
8-16S	25,4	1.00	1/2-14	1 5/16-12	45,2	1.78	46,0	1.81
12-6S	9,6	0.38	3/4-14	9/16-18	40,4	1.59	33,3	1.31
12-8S	12,7	0.50	3/4-14	3/4-16	40,4	1.59	36,1	1.42
12-10S	16,0	0.63	3/4-14	7/8-14	40,4	1.59	39,1	1.54
12-12S	19,0	0.75	3/4-14	1 1/16-12	40,4	1.59	42,2	1.66
12-16S	25,4	1.00	3/4-14	1 5/16-12	45,2	1.78	46,0	1.81
12-20S	31,7	1.25	3/4-14	1 5/8-12	54,9	2.16	52,3	2.06
16-8S	12,7	0.50	1-11 1/2	3/4-16	50,0	1.97	38,6	1.52
16-10S	16,0	0.63	1-11 1/2	7/8-14	50,0	1.97	41,9	1.65
16-12S	19,0	0.75	1-11 1/2	1 1/16-12	50,0	1.97	44,7	1.76
16-16S	25,4	1.00	1-11 1/2	1 5/16-12	50,0	1.97	46,0	1.81
16-20S	31,7	1.25	1-11 1/2	1 5/8-12	59,7	2.35	52,3	2.06
20-16S	25,4	1.00	1 1/4-11 1/2	1 5/16-12	60,5	2.38	51,1	2.01
20-20S	31,7	1.25	1 1/4-11 1/2	1 5/8-12	60,5	2.38	52,3	2.06
20-24S	38,1	1.50	1 1/4-11 1/2	1 7/8-12	66,3	2.61	59,2	2.33
24-20S	31,7	1.25	1 1/2-11 1/2	1 5/8-12	67,1	2.64	55,9	2.20
24-24S	38,1	1.50	1 1/2-11 1/2	1 7/8-12	67,1	2.64	59,2	2.33
24-32S	50,8	2.00	1 1/2-11 1/2	2 1/2-12	75,4	2.97	77,7	3.06
32-32S	50,8	2.00	2-11 1/2	2 1/2-12	76,2	3.00	77,7	3.06

Adapters and tube fittings

Pipe to 37° flare

J

Pipe to 37° flare

Extra pipe/37° flare

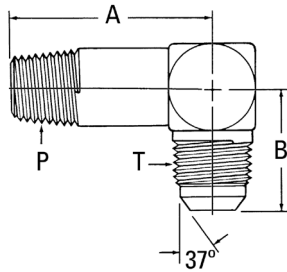

Part no. 202411-(Dash size) (Ref. SAE 071502)

Dash size	Tube O. D.		Thread P	Thread T	A		B	
	mm	in			mm	in	mm	in
2-4S	6,3	0.25	1/8-27	7/16-20	29,7	1.17	22,6	0.89
2-5S	7,9	0.31	1/8-27	1/2-20	29,7	1.17	24,1	0.95
4-4S	6,3	0.25	1/4-18	7/16-20	40,1	1.58	26,7	1.05
4-6S	9,6	0.38	1/4-18	9/16-18	40,1	1.58	26,9	1.06
4-8S	12,7	0.50	1/4-18	3/4-16	46,2	1.82	31,8	1.25
6-6S	9,6	0.38	3/8-18	9/16-18	46,2	1.82	29,0	1.14
6-8S	12,7	0.50	3/8-18	3/4-16	46,2	1.82	31,8	1.25
8-8S	12,7	0.50	1/2-14	3/4-16	55,1	2.17	33,8	1.33
8-10S	16,0	0.63	1/2-14	7/8-14	55,1	2.17	36,8	1.45
8-12S	19,0	0.75	1/2-14	1 1/16-12	62,0	2.44	42,2	1.66
12-10S	16,0	0.63	3/4-14	7/8-14	62,0	2.44	39,1	1.54
12-12S	19,0	0.75	3/4-14	1 1/16-12	62,0	2.44	42,2	1.66
12-16S	25,4	1.00	3/4-14	1 5/16-12	71,6	2.82	46,0	1.81
16-16S	25,4	1.00	1-11 1/2	1 5/16-12	76,5	3.01	46,0	1.81
20-20S	31,70	1.25	1 1/4-11 1/2	1 5/8-12	93,7	3.69	52,3	2.06

Long external pipe/37° flare

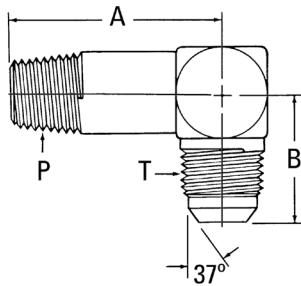

Part no. 202413-(Dash size) (Ref. SAE 071602)

Dash size	Tube O. D.		Thread P	Thread T	A		B	
	mm	in			mm	in	mm	in
2-4S	6,3	0.25	1/8-27	7/16-20	39,6	1.56	22,6	0.89
2-5S	7,9	0.31	1/8-27	1/2-20	41,4	1.63	24,1	0.95
4-4S	6,3	0.25	1/4-18	7/16-20	52,6	2.07	26,7	1.05
4-5S	7,9	0.31	1/4-18	1/2-20	52,6	2.07	26,7	1.05
4-6S	9,6	0.38	1/4-18	9/16-18	52,6	2.07	26,9	1.06
6-6S	9,6	0.38	3/8-18	9/16-18	61,5	2.42	29,0	1.14
6-8S	12,7	0.50	3/8-18	3/4-16	61,5	2.42	31,8	1.25
8-8S	12,7	0.50	1/2-14	3/4-16	72,9	2.87	33,8	1.33
8-10S	16,0	0.63	1/2-14	7/8-14	72,9	2.87	36,8	1.45
8-12S	19,0	0.75	1/2-14	1 1/16-12	83,3	3.28	42,2	1.66
12-12S	19,0	0.75	3/4-14	1 1/16-12	83,3	3.28	42,2	1.66
12-16S	25,4	1.00	3/4-14	1 5/16-12	98,0	3.86	46,0	1.81
16-16S	25,4	1.00	1-11 1/2	1 5/16-12	102,9	4.05	46,0	1.81
20-20S	31,7	1.25	1 1/4-11 1/2	1 5/8-12	122,9	4.84	52,3	2.06

Pipe to 37° flare

Extra long external pipe/37° flare

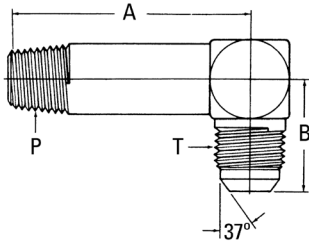

Part no. 202414-(Dash size)

Dash size	Tube O. D.		Thread P	Thread T	A		B	
	mm	in			mm	in	mm	in
2-4S	6,3	0.25	1/8-27	7/16-20	58,7	2.31	22,6	0.89
4-4S	6,3	0.25	1/4-18	7/16-20	75,9	2.99	24,6	0.97
8-10S	16,0	0.63	1/2-14	7/8-14	114,5	4.51	36,8	1.45

External pipe/37° flare swivel

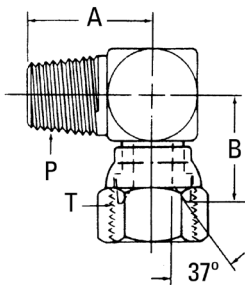

Part no. 2250-(Dash size)

Dash size	Tube O. D.		Thread P	Thread T	A		B	
	mm	in			mm	in	mm	in
2-4S	6,3	0.25	1/8-27	7/16-20	19,8	0.78	16,8	0.66
2-5S	7,9	0.31	1/8-27	1/2-20	19,8	0.78	17,3	0.68
4-6S	9,6	0.38	1/4-18	9/16-18	27,7	1.09	22,3	0.88
6-6S	9,6	0.38	3/8-18	9/16-18	31,0	1.22	21,6	0.85
6-8S	12,7	0.50	3/8-18	3/4-16	31,0	1.22	24,4	0.96
8-8S	12,7	0.50	1/2-14	3/4-16	37,3	1.47	25,4	1.00
8-10S	16,0	0.63	1/2-14	7/8-14	37,3	1.47	28,5	1.12
12-8S	12,7	0.50	3/4-14	3/4-16	40,4	1.59	29,7	1.17
12-12S	19,0	0.75	3/4-14	1 1/16-12	40,4	1.59	30,3	1.19
12-14S	22,3	0.88	3/4-14	1 3/16-12	42,9	1.69	30,5	1.20
16-16S	25,4	1.00	1-11 1/2	1 5/16-12	50,0	1.97	35,8	1.41
20-20S	31,7	1.25	1 1/4-11 1/2	1 5/8-12	60,4	2.38	42,7	1.68
24-24S	38,1	1.50	1 1/2-11 1/2	1 7/8-12	67,0	2.64	47,2	1.86

External pipe swivel/37° flare

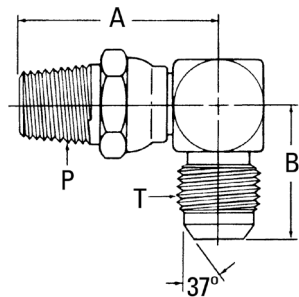

Part no. 2249- (Dash size)

Dash size	Tube O. D.		Thread P	Thread T	A		B	
	mm	in			mm	in	mm	in
4-6S	9,6	0.38	1/4-18	9/16-18	40,6	1.60	26,9	1.06
6-8S	12,7	0.50	3/8-18	3/4-16	43,4	1.71	31,0	1.22
8-10S	16,0	0.63	1/2-14	7/8-14	50,8	2.00	36,8	1.45
12-12S	19,0	0.75	3/4-14	1 1/16-12	41,1	1.62	42,2	1.66

Note: The above adapter is not a rotating union or swivel joint. Care must be exercised to avoid misuse. To be used with petroleum or water glycol fluids.

Adapters and tube fittings

Pipe to 37° flare

J

Pipe to 37° flare

Internal pipe/37° flare swivel

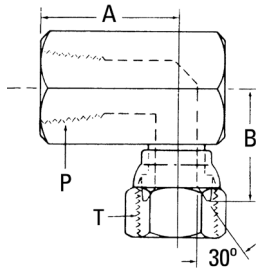

Part no. 2244-(Dash size)

Dash size	Tube O. D.		Thread P	Thread T	A		B	
	mm	in			mm	in	mm	in
6-6S	9,6	0.38	3/8-18	9/16-18	25,9	1.02	23,4	0.92
8-6S	9,6	0.38	1/2-14	9/16-18	31,2	1.23	26,2	1.03
8-8S	12,7	0.50	1/2-14	3/4-16	31,2	1.23	27,4	1.08
8-10S	16,0	0.63	1/2-14	7/8-14	31,2	1.23	28,5	1.12

Internal pipe/37° flare

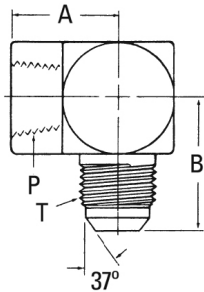

Part no. 2025-(Dash size) (Ref. SAE 070203)

Dash size	Tube O. D.		Thread P	Thread T	A		B	
	mm	in			mm	in	mm	in
2-4S	6,3	0.25	1/8-27	7/16-20	16,8	0.66	27,4	1.08
2-5S	7,9	0.31	1/8-27	1/2-20	16,8	0.66	27,4	1.08
2-6S	9,6	0.38	1/8-27	9/16-18	17,0	0.67	31,2	1.23
4-4S	6,3	0.25	1/4-18	7/16-20	22,4	0.88	31,0	1.22
4-5S	7,9	0.31	1/4-18	1/2-20	22,4	0.88	31,0	1.22
4-6S	9,6	0.38	1/4-18	9/16-18	22,4	0.88	31,2	1.23
4-8S	12,7	0.50	1/4-18	3/4-16	25,7	1.01	36,1	1.42
6-4S	6,3	0.25	3/8-18	7/16-20	25,9	1.02	32,8	1.29
6-5S	7,9	0.31	3/8-18	1/2-20	25,9	1.02	32,8	1.29
6-6S	9,6	0.38	3/8-18	9/16-18	25,9	1.02	33,3	1.31
6-8S	12,7	0.50	3/8-18	3/4-16	25,9	1.02	36,1	1.42
8-4S	6,3	0.25	1/2-14	7/16-20	31,2	1.23	35,6	1.40
8-5S	7,9	0.31	1/2-14	1/2-20	31,2	1.23	35,6	1.40
8-8S	12,7	0.50	1/2-14	3/4-16	31,2	1.23	38,6	1.52
8-10S	16,0	0.63	1/2-14	7/8-14	31,2	1.23	41,7	1.64
8-12S	19,0	0.75	1/2-14	1 1/16-12	34,3	1.35	48,0	1.89
12-12S	19,0	0.75	3/4-14	1 1/16-12	34,5	1.36	48,0	1.89
16-16S	25,4	1.00	1-11 1/2	1 5/8-12	41,1	1.62	55,1	2.17
20-20S	31,7	1.25	1 1/4-11 1/2	1 5/8-12	43,2	1.70	59,2	2.33
24-24S	38,1	1.50	1 1/2-11 1/2	1 7/8-12	52,8	2.08	73,4	2.89
32-32S	50,8	2.00	2-11 1/2	2 1/2-12	60,7	2.39	83,8	3.30

External pipe/37° flare

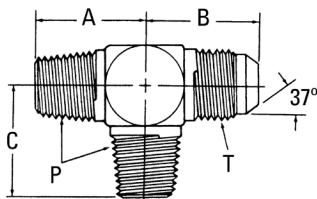

Part no. 203007-(Dash size)

Dash size	Tube O. D.		Thread P	Thread T	A		B		C	
	mm	in			mm	in	mm	in		
2-4S	6,3	0.25	1/8-27	7/16-20	19,8	0.78	22,6	0.89	19,8	0.78
4-6S	9,6	0.38	1/4-18	9/16-18	27,7	1.09	26,9	1.06	27,7	1.09
6-8S	12,7	0.50	3/8-18	3/4-16	31,0	1.22	31,8	1.25	31,0	1.22
12-12S	19,0	0.75	3/4-14	1 1/16-12	40,4	1.59	42,2	1.66	40,4	1.59
16-16S	25,4	1.00	1-11 1/2	1 5/8-12	50,0	1.97	46,0	1.81	50,0	1.97

Pipe to 37° flare

External pipe/internal pipe/37° flare

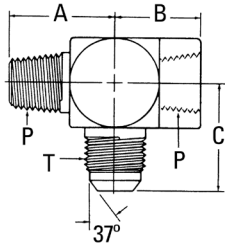

Part no. 203301-(Dash size)

Dash size	Tube O. D.		Thread P	Thread T	A		B		C	
	mm	in			mm	in	mm	in	mm	in
2-4S	6,3	0.25	1/8-27	7/16-20	19,8	0.78	16,8	0.66	27,4	1.08
4-6S	9,6	0.38	1/4-18	9/16-18	27,7	1.09	22,3	0.88	31,2	1.23
6-8S	12,7	0.50	3/8-18	3/4-16	31,0	1.22	25,9	1.02	36,1	1.42
8-10S	16,0	0.63	1/2-14	7/8-14	37,3	1.47	31,2	1.23	41,6	1.64
12-12S	19,0	0.75	3/4-14	1 1/16-12	40,4	1.59	34,5	1.36	48,0	1.89
16-16S	25,4	1.00	1-11 1/2	1 5/16-12	50,0	1.97	41,1	1.62	55,2	2.17

External pipe/37° flare/internal pipe

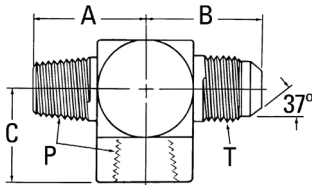

Part no. 203103-(Dash size)

Dash size	Tube O. D.		Thread P	Thread T	A		B		C	
	mm	in			mm	in	mm	in	mm	in
2-4S	6,3	0.25	1/8-27	7/16-20	19,8	0.78	27,4	1.08	16,8	0.66
4-6S	9,6	0.38	1/4-18	9/16-18	27,7	1.09	31,2	1.23	22,3	0.88
6-6S	9,6	0.38	3/8-18	9/16-18	31,0	1.22	33,3	1.31	25,9	1.02
6-8S	12,7	0.50	3/8-18	3/4-16	31,0	1.22	36,1	1.42	25,9	1.02
8-10S	16,0	0.63	1/2-14	7/8-14	37,3	1.47	41,6	1.64	31,2	1.23
12-12S	19,0	0.75	3/4-14	1 1/16-12	40,4	1.59	48,0	1.89	34,5	1.36
16-16S	25,4	1.00	1-11 1/2	1 5/16-12	53,1	2.09	53,1	2.09	42,1	1.62

External pipe/37° flare

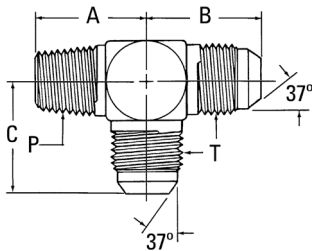

Part no. 2028-(Dash size) (Ref. SAE 070424)

Dash size	Tube O. D.		Thread P	Thread T	A		B		C	
	mm	in			mm	in	mm	in	mm	in
2-3S	4,8	0.19	1/8-27	3/8-24	18,3	0.72	21,1	0.83	21,1	0.83
2-4S	6,3	0.25	1/8-27	7/16-20	19,8	0.78	22,6	0.89	22,6	0.89
4-4S	6,3	0.25	1/4-18	7/16-20	27,7	1.09	26,7	1.05	26,7	1.05
4-5S	7,9	0.31	1/4-18	1/2-20	27,7	1.09	26,7	1.05	26,7	1.05
4-6S	9,6	0.38	1/4-18	9/16-18	27,7	1.09	26,9	1.06	26,9	1.06
6-6S	9,6	0.38	3/8-18	9/16-18	31,0	1.22	29,0	1.14	29,0	1.14
6-8S	12,7	0.50	3/8-18	3/4-16	31,0	1.22	31,8	1.25	31,8	1.25
8-8S	12,7	0.50	1/2-14	3/4-16	37,3	1.47	33,8	1.33	33,8	1.33
8-10S	16,0	0.63	1/2-14	7/8-14	37,3	1.47	36,8	1.45	36,8	1.45
8-12S	19,0	0.75	1/2-14	1 1/16-12	40,4	1.59	42,2	1.66	42,2	1.66
12-10S	16,0	0.63	3/4-14	7/8-14	40,4	1.59	39,1	1.54	39,1	1.54
12-12S	19,0	0.75	3/4-14	1 1/16-12	40,4	1.59	42,2	1.66	42,2	1.66
16-16S	25,4	1.00	1-11 1/2	1 5/16-12	50,0	1.97	46,0	1.81	46,0	1.81
20-20S	31,7	1.25	1 1/4-11 1/2	1 5/8-12	60,5	2.38	52,3	2.06	52,3	2.06
24-24S	38,1	1.50	1 1/2-11 1/2	1 7/8-12	67,1	2.64	59,2	2.33	59,2	2.33
32-32S	50,8	2.00	2-11 1/2	2 1/2-12	76,2	3.00	77,7	3.06	77,7	3.06

Adapters and tube fittings

Pipe to 37° flare

J

Pipe to 37° flare

External pipe/internal pipe/37° flare

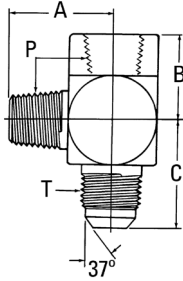

Part no. 203006-(Dash size)

Dash size	Tube O. D.		Thread P	Thread T	A		B		C	
	mm	in			mm	in	mm	in	mm	in
2-4S	6,3	0.25	1/8-27	7/16-20	27,4	1.08	16,8	0.66	19,8	0.78
4-6S	9,6	0.38	1/4-18	9/16-18	27,7	1.09	22,3	0.88	31,2	1.23
6-8S	12,7	0.50	3/8-18	3/4-16	31,0	1.22	25,9	1.02	36,1	1.42
12-12S	19,0	0.75	3/4-14	1 1/16-12	40,4	1.59	34,5	1.36	48,0	1.89
16-16S	25,4	1.00	1-11 1/2	1 5/16-12	50,0	1.97	42,1	1.62	55,1	2.17
20-20S	31,7	1.25	1 1/4-11 1/2	1 5/8-12	59,2	2.33	43,2	1.70	60,5	2.38

External pipe/37° flare

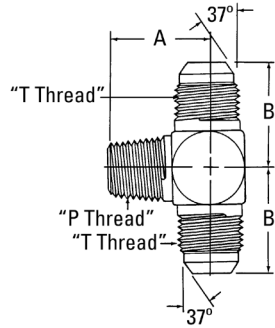

Part no. 2030-(Dash size) (Ref. SAE 070425)

Dash size	Tube O.D.		Thread P	Thread T	A		B	
	mm	in			mm	in	mm	in
2-4S	6,3	0.25	1/8-27	7/16-20	19,8	0.78	22,6	0.89
4-4S	6,3	0.25	1/4-18	7/16-20	27,7	1.09	26,7	1.05
4-5S	7,9	0.31	1/4-18	1/2-20	27,7	1.09	26,7	1.05
4-6S	9,6	0.38	1/4-18	9/16-18	27,7	1.09	26,9	1.06
6-6S	9,6	0.38	3/8-18	9/16-18	31,0	1.22	29,0	1.14
6-8S	12,7	0.50	3/8-18	3/4-16	31,0	1.22	31,8	1.25
6-10S	16,0	0.63	3/8-18	7/8-14	32,5	1.28	36,8	1.45
8-6S	9,6	0.38	1/2-14	9/16-18	37,3	1.47	31,0	1.22
8-8S	12,7	0.50	1/2-14	3/4-16	37,3	1.47	33,8	1.33
8-10S	16,0	0.63	1/2-14	7/8-14	37,3	1.47	36,8	1.45
12-12S	19,0	0.75	3/4-14	1 1/16-12	40,4	1.59	42,2	1.66
12-16S	25,4	1.00	3/4-14	1 5/16-12	45,2	1.78	46,0	1.81
16-16S	25,4	1.00	1-11 1/2	1 5/16-12	50,0	1.97	46,0	1.81
20-20S	31,7	1.25	1 1/4-11 1/2	1 5/8-12	60,5	2.38	52,3	2.06

Internal pipe/37° flare

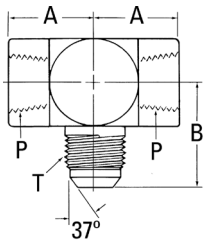

Part no. 202901-(Dash size)

Dash size	Tube O.D.		Thread P	Thread T	A		B	
	mm	in			mm	in	mm	in
4-6S	9,6	0.38	1/4-18	9/16-18	22,3	0.88	31,2	1.23
6-8S	12,7	0.50	3/8-18	3/4-16	25,9	1.02	36,1	1.42
12-12S	19,0	0.75	3/4-14	1 1/16-12	34,5	1.36	48,0	1.89
16-16S	25,4	1.00	1-11 1/2	1 5/16-12	42,1	1.62	55,1	2.17

Internal Pipe/ internal Pipe/37° Flare

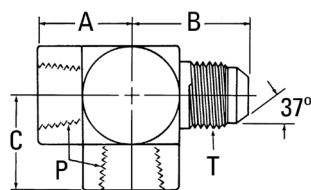

Part no. 203104-(Dash size) (Ref. SAE 070427)

Dash size	Tube O.D.		Thread P	Thread T	A		B		C	
	mm	in			mm	in	mm	in	mm	in
2-4S	6,3	0.25	1/8-27	7/16-20	16,8	0.66	27,4	1.08	16,8	0.66
4-6S	9,6	0.38	1/4-18	9/16-18	22,3	0.88	31,2	1.23	22,3	0.88
8-10S	16,1	0.63	1/2-14	7/8-14	31,2	1.23	41,6	1.64	31,2	1.23
16-16S	25,4	1.00	1-11 1/2	1 5/16-12	42,1	1.62	55,1	2.17	42,1	1.62

Pipe to 37° flare

Internal pipe/37° flare

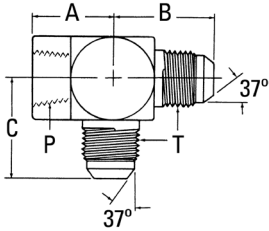

Part no. 2029-(Dash size) (Ref. SAE 070426)

Dash size	Tube O.D.		Thread P	Thread T	A		B		C	
	mm	in			mm	in	mm	in	mm	in
2-4S	6,3	0.25	1/8-27	7/16-20	16,8	0.66	27,4	1.08	24,1	0.95
4-4S	6,3	0.25	1/4-18	7/16-20	22,4	0.88	25,4	1.00	25,4	1.00
4-6S	9,6	0.38	1/4-18	9/16-18	22,6	0.89	31,2	1.23	28,2	1.11
8-8S	12,7	0.50	1/2-14	3/4-16	31,2	1.23	36,1	1.42	35,6	1.40
12-12S	19,0	0.75	3/4-14	1 1/16-12	34,5	1.36	48,0	1.89	48,0	1.89
16-16S	25,4	1.00	1-11 1/2	1 5/16-12	41,1	1.62	55,2	2.17	53,1	2.09

Internal pipe/37° flare swivel

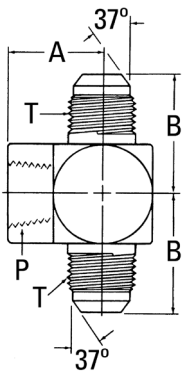

Part no. 2031-(Dash size) (Ref. SAE 070427)

Dash size	Tube O.D.		Thread P	Thread T	A		B	
	mm	in			mm	in	mm	in
2-3S	4,8	0.19	1/8-27	3/8-24	16,8	0.66	26,2	1.03
2-4S	6,3	0.25	1/8-27	7/16-20	16,8	0.66	27,4	1.08
2-5S	7,9	0.31	1/8-27	1/2-20	16,8	0.66	27,4	1.08
4-4S	6,3	0.25	1/4-18	7/16-20	22,4	0.88	31,0	1.22
4-6S	9,6	0.38	1/4-18	9/16-18	22,4	0.88	31,2	1.23
6-8S	12,7	0.50	3/8-18	3/4-16	25,9	1.02	36,1	1.42
8-8S	12,7	0.50	1/2-14	3/4-16	31,2	1.23	38,6	1.52
8-10S	16,0	0.63	1/2-14	7/8-14	31,2	1.23	41,6	1.64
12-12S	19,0	0.75	3/4-14	1 1/16-12	34,5	1.36	48,0	1.89
16-16S	25,4	1.00	1-11 1/2	1 5/16-12	41,1	1.62	53,1	2.09
32-32S	50,8	2.00	2-11 1/2	2 1/2-12	60,7	2.39	83,8	3.30

External pipe/37° flare

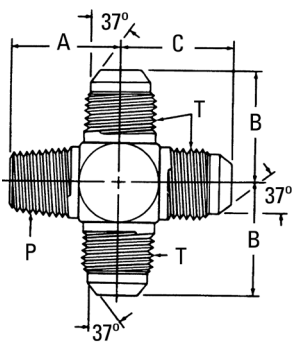

Part no. 202003-(Dash size)

Dash size	Tube O.D.		Thread P	Thread T	A		B		C	
	mm	in			mm	in	mm	in	mm	in
6-6S	9,6	0.38	3/8-18	9/16-18	26,9	1.06	26,9	1.06	26,9	1.06

Adapters and tube fittings

Pipe to 45° flare

J

Pipe to 45° flare – Brass

External pipe/45° flare

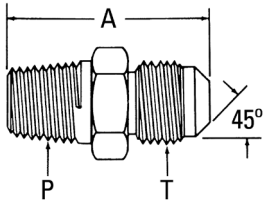

Part no. 2000-(Dash size) (Ref. SAE 010102)

Dash size	Tube O.D.		Thread P	Thread T	A	
	mm	in			mm	in
2-4B	6,3	0.25	1/8-27	7/16-20	26,9	1.06
2-5B	7,9	0.31	1/8-27	1/2-20	29,5	1.16
2-6B	9,6	0.38	1/8-27	5/8-18	31,8	1.25
4-4B	6,3	0.25	1/4-18	7/16-20	31,8	1.25
4-5B	7,9	0.31	1/4-18	1/2-20	34,0	1.34
4-6B	9,6	0.38	1/4-18	5/8-18	36,6	1.44
4-8B	12,7	0.50	1/4-18	3/4-16	41,1	1.62
6-4B	6,3	0.25	3/8-18	7/16-20	33,3	1.31
6-5B	7,9	0.31	3/8-18	1/2-20	35,1	1.38
6-6B	9,6	0.38	3/8-18	5/8-18	36,6	1.44
6-8B	12,7	0.50	3/8-18	3/4-16	41,1	1.62
6-10B	16,0	0.63	3/8-18	7/8-14	46,0	1.81
8-4B	6,3	0.25	1/2-14	7/16-20	39,6	1.56
8-6B	9,6	0.38	1/2-14	5/8-18	42,9	1.69
8-8B	12,7	0.50	1/2-14	3/4-16	46,0	1.81
8-10B	16,0	0.63	1/2-14	7/8-14	50,8	2.00
8-12B	19,0	0.75	1/2-14	1 1/16-14	55,6	2.19
12-8B	12,7	0.50	3/4-14	3/4-16	49,3	1.94
12-10B	16,0	0.63	3/4-14	7/8-14	52,3	2.06
12-12B	19,0	0.75	3/4-14	1 1/16-14	55,6	2.19

For more brass fittings see E-BRFI-MC001-E

Internal pipe/45° flare

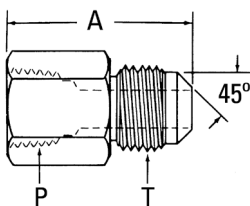

Part no. 2001-(Dash size) (Ref. SAE 010103)

Dash size	Tube O.D.		Thread P	Thread T	A	
	mm	in			mm	in
2-4B	6,3	0.25	1/8-27	7/16-20	26,9	1.06
2-5B	7,9	0.31	1/8-27	1/2-20	29,5	1.16
2-6B	6,3	0.25	1/8-27	9/16-18	28,4	1.12
4-4B	6,3	0.25	1/4-18	7/16-20	30,3	1.19
4-5B	7,9	0.31	1/4-18	1/2-20	31,8	1.25
4-6B	9,6	0.38	1/4-18	5/8-18	33,3	1.31
6-4B	6,3	0.25	3/8-18	7/16-20	30,3	1.19
6-6B	9,6	0.38	3/8-18	5/8-18	33,3	1.31
6-8B	12,7	0.50	3/8-18	3/4-16	39,6	1.56
6-10B	16,0	0.63	3/8-18	7/8-14	39,6	1.56
8-6B	9,6	0.38	1/2-14	5/8-18	38,1	1.50
8-8B	12,7	0.50	1/2-14	3/4-16	41,1	1.62
8-10B	16,0	0.63	1/2-14	7/8-14	46,0	1.81
8-12B	19,0	0.75	1/2-14	1 1/16-14	50,8	2.00
12-10B	16,0	0.63	3/4-14	7/8-14	46,0	1.81
12-12B	19,0	0.75	3/4-14	1 1/16-14	49,3	1.94

Pipe to 45° flare – Brass

External pipe/45° flare

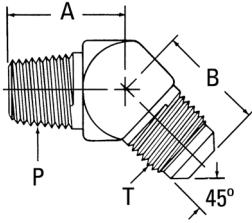

Part no. 2007-(Dash size) (Ref. SAE 010302)

Dash size	Tube O.D.		Thread P	Thread T	A		B	
	mm	in			mm	in	mm	in
2-4B	6,3	0.25	1/8-27	7/16-20	16,2	0.64	17,3	0.68
4-4B	6,3	0.25	1/4-18	7/16-20	20,8	0.82	17,8	0.70
4-6B	9,6	0.38	1/4-18	5/8-18	21,8	0.86	22,6	0.89
6-6B	9,6	0.38	3/8-18	5/8-18	24,1	0.95	24,6	0.97
6-8B	12,7	0.50	3/8-18	3/4-16	24,4	0.96	29,2	1.15
6-10B	16,0	0.63	3/8-18	7/8-14	24,9	0.98	31,2	1.23
8-6B	9,6	0.38	1/2-14	5/8-18	29,7	1.17	25,1	0.99
8-8B	12,7	0.50	1/2-14	3/4-16	29,7	1.17	28,5	1.12
8-10B	16,0	0.63	1/2-14	7/8-14	29,7	1.17	31,2	1.23

For more brass fittings see E-BRFI-MC001-E

External pipe/45° flare

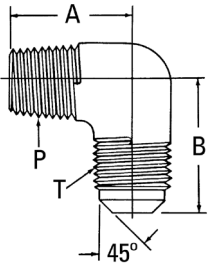

Part no. 2003-(Dash size) (Ref. SAE 010202)

Dash size	Tube O.D.		Thread P	Thread T	A		B	
	mm	in			mm	in	mm	in
2-4B	6,3	0.25	1/8-27	7/16-20	19,3	0.76	20,1	0.79
2-5B	7,9	0.31	1/8-27	1/2-20	19,8	0.78	23,1	0.91
2-6B	9,6	0.38	1/8-27	5/8-18	23,1	0.91	26,2	1.03
4-4B	6,3	0.25	1/4-18	7/16-20	22,4	0.88	25,1	0.99
4-5B	7,9	0.31	1/4-18	1/2-20	23,3	0.92	24,1	0.95
4-6B	9,6	0.38	1/4-18	5/8-18	26,7	1.05	24,7	0.98
4-8B	12,7	0.50	1/4-18	3/4-16	30,2	1.19	31,2	1.23
6-4B	6,3	0.25	3/8-18	7/16-20	26,2	1.03	23,9	0.94
6-5B	7,9	0.31	3/8-18	1/2-20	23,1	0.91	25,4	1.00
6-6B	9,6	0.38	3/8-18	5/8-18	27,7	1.09	26,4	1.04
6-8B	12,7	0.50	3/8-18	3/4-16	28,4	1.12	31,2	1.23
6-10B	16,0	0.63	3/8-18	7/8-14	31,0	1.22	36,1	1.42
8-6B	9,6	0.38	1/2-14	5/8-18	34,3	1.35	29,5	1.16
8-8B	12,7	0.50	1/2-14	3/4-16	31,8	1.25	33,5	1.32
8-10B	16,0	0.63	1/2-14	7/8-14	34,8	1.37	36,1	1.42
8-12B	19,0	0.75	1/2-14	1 1/16-14	37,6	1.48	41,1	1.62
12-8B	12,7	0.50	3/4-14	3/4-16	37,6	1.48	41,1	1.62
12-10B	16,0	0.63	3/4-14	7/8-14	33,3	1.31	36,3	1.43
12-12B	19,0	0.75	3/4-14	1 1/16-14	38,1	1.50	41,1	1.62

Internal pipe/45° flare

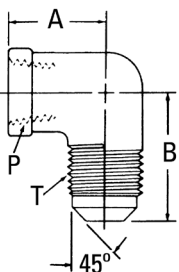

Part no. 2002-(Dash size) (Ref. SAE 010203)

Dash size	Tube O.D.		Thread P	Thread T	A		B	
	mm	in			mm	in	mm	in
2-4B	6,3	0.25	1/8-27	7/16-20	11,7	0.46	22,9	0.90
4-4B	6,3	0.25	1/4-18	7/16-20	17,5	0.69	25,4	0.97
4-6B	9,6	0.38	1/4-18	5/8-18	17,5	0.69	27,7	1.09
6-4B	6,3	0.25	3/8-18	7/16-20	14,5	0.57	26,2	1.03
6-6B	9,6	0.38	3/8-18	5/8-18	27,7	1.09	26,9	1.06
6-8B	12,7	0.50	3/8-18	3/4-16	28,4	1.12	32,5	1.28
6-10B	16,0	0.63	3/8-18	7/8-14	31,0	1.22	34,3	1.35
8-8B	12,7	0.50	1/2-14	3/4-16	23,9	0.94	35,1	1.38
8-10B	16,0	0.63	1/2-14	7/8-14	25,4	1.00	38,1	1.50
8-12B	19,0	0.75	1/2-14	1 1/16-14	26,9	1.06	41,4	1.63
12-12B	19,0	0.75	3/4-14	1 1/16-14	26,9	1.06	45,2	1.78

Adapters and tube fittings

Pipe to SAE O-Ring boss

J

Pipe to SAE O-Ring boss

External pipe/SAE O-Ring boss (internal)

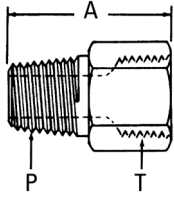

Part no. 2246-(Dash size)

Dash size	Thread P	Thread T	A	
			mm	in
2-4S	1/8-27	7/16-20	27,7	1.09
2-5S	1/8-27	1/2-20	27,7	1.09
4-6S	1/4-18	9/16-18	34,5	1.36
6-8S	3/8-18	3/4-16	36,8	1.45
8-10S	1/2-14	7/8-14	45,2	1.78
12-12S	3/4-14	1 1/16-12	48,8	1.92
12-14S	3/4-14	1 3/16-12	48,8	1.92
16-16S	1-11 1/2	1 5/16-12	54,1	2.13

Internal pipe swivel (NPSM)/SAE O-Ring boss

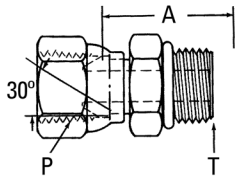

Part no. 2066-(Dash size)

Dash size	Thread P	Thread T	A	
			mm	in
4-4S	1/4-18	7/16-20	26,7	1.05
4-6S	1/4-18	9/16-18	29,0	1.14
6-6S	3/8-18	9/16-18	29,0	1.14
6-8S	3/8-18	3/4-16	30,3	1.19
8-8S	1/2-14	3/4-16	31,2	1.23
8-10S	1/2-14	7/8-14	33,0	1.30
12-8S	3/4-14	3/4-16	37,8	1.49
12-10S	3/4-14	7/8-14	39,4	1.55
12-12S	3/4-14	1 1/16-12	40,1	1.58
12-14S	3/4-14	1 3/16-12	40,1	1.58
16-16S	1-11 1/2	1 5/16-12	40,4	1.59
16-20S	1-11 1/2	1 5/8-12	40,4	1.59

Note: Available without O-Ring. Order by Part no. 206604-(Dash size).

Pipe to SAE O-Ring boss

Internal pipe/SAE O-Ring boss

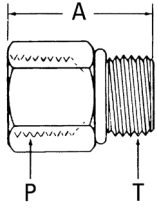

Part no. 2216-(Dash size)

Dash size	Thread P	Thread T	A	
			mm	in
2-4S	1/8-27	7/16-20	23,4	0.92
2-5S	1/8-27	1/2-20	31,0	1.22
4-4S	1/4-18	7/16-20	30,5	1.20
4-5S	1/4-18	1/2-20	30,5	1.20
4-6S	1/4-18	9/16-18	31,5	1.24
6-6S	3/8-18	9/16-18	33,0	1.30
6-8S	3/8-18	3/4-16	31,8	1.25
6-12S	3/8-18	1 1/16-12	34,0	1.34
8-8S	1/2-14	3/4-16	41,9	1.65
8-10S	1/2-14	7/8-14	39,1	1.54
8-12S	1/2-14	1 1/16-12	43,7	1.72
8-16S	1/2-14	1 5/16-12	25,4	1.00
12-10S	3/4-14	7/8-14	45,0	1.77
12-12S	3/4-14	1 1/16-12	42,4	1.67
12-14S	3/4-14	1 3/16-12	42,7	1.68
12-16S	3/4-14	1 5/16-12	25,4	1.00
16-16S	1-11 1/2	1 5/16-12	48,5	1.91
16-20S	1-11 1/2	1 5/8-12	25,4	1.00
20-20S	1 1/4-11 1/2	1 5/8-12	50,8	2.00
24-24S	1 1/2-11 1/2	1 7/8-12	50,8	2.00
32-32S	2-11 1/2	2 1/2-12	53,3	2.10

Note: Also available without O-Ring. Order by Part no. 2216-1-(Dash size).

Internal pipe swivel (NPSM)/SAE O-Ring boss (adj.)

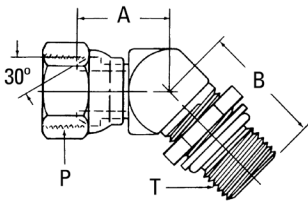

Part no. 2067-(Dash size)

Dash size	Thread P	Thread T	A		B	
			mm	in	mm	in
6-6S	3/8-18	9/16-18	23,4	0.92	30,5	1.20
6-8S	3/8-18	3/4-16	23,4	0.92	33,8	1.33
8-8S	1/2-14	3/4-16	23,1	0.91	35,3	1.39
8-10S	1/2-14	7/8-14	23,1	0.91	39,4	1.55
12-12S	3/4-14	1 1/16-12	27,9	1.10	44,7	1.76
12-16S	3/4-14	1 5/16-12	27,9	1.10	48,0	1.89
16-16S	1-11 1/2	1 5/16-12	32,0	1.26	48,0	1.89

Note: Available without O-Ring. Order by Part no. 2067-1-(Dash size).

Adapters and tube fittings

Pipe to SAE O-Ring boss

J

Pipe to SAE O-Ring boss

Internal pipe swivel (NPSM)/SAE O-Ring boss (adj.)

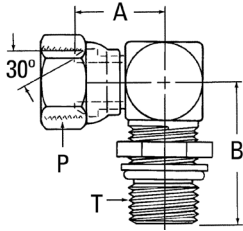

Part no. 2068-(Dash size)

Dash size	Thread P	Thread T	A		B	
			mm	in	mm	in
4-4S	1/4-18	7/16-20	23,1	0.91	29,5	1.16
4-6S	1/4-18	9/16-18	23,1	0.91	31,0	1.22
6-6S	3/8-18	9/16-18	27,7	1.09	34,3	1.35
6-8S	3/8-18	3/4-16	27,7	1.09	37,6	1.48
6-10S	3/8-18	7/8-14	27,7	1.09	42,4	1.67
8-6S	1/2-14	9/16-18	27,4	1.08	38,4	1.51
8-8S	1/2-14	3/4-16	27,4	1.08	38,4	1.51
8-10S	1/2-14	7/8-14	27,4	1.08	42,4	1.67
8-12S	1/2-14	1 1/16-12	30,0	1.18	50,0	1.97
12-8S	3/4-14	3/4-16	33,0	1.30	41,9	1.65
12-10S	3/4-14	7/8-14	33,5	1.32	46,0	1.81
12-12S	3/4-14	1 1/16-12	34,5	1.36	50,0	1.97
12-16S	3/4-14	1 5/16-12	35,8	1.41	53,8	2.12
16-16S	1-11 1/2	1 5/16-12	38,9	1.53	53,8	2.12
20-16S	1 1/4-11 1/2	1 5/16-12	46,2	1.82	63,5	2.50
20-20S	1 1/4-11 1/2	1 5/8-12	46,2	1.82	63,5	2.50

Note: Available without O-Ring. Order by Part no. 2061-1-(Dash size).

Internal pipe/SAE O-Ring boss (adj.)

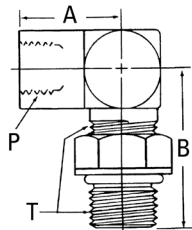

Part no. 206801-(Dash size)

Dash size	Thread P	Thread T	A		B	
			mm	in	mm	in
6-8S	3/8-18	3/4-16	25,9	1.02	41,1	1.62
8-8S	1/2-14	3/4-16	31,2	1.23	43,9	1.73
12-12S	3/4-14	1 1/16-12	34,5	1.36	55,2	2.17
16-16S	1-11 1/2	1 5/16-12	41,1	1.62	61,2	2.41

Note: Available without O-Ring. Order by Part no. 206801-1-(Dash size).

Internal pipe/SAE O-Ring boss (adj.)

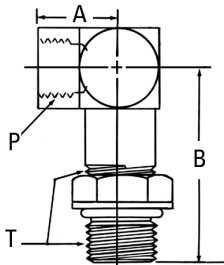

Part no. 206804-(Dash size)

Dash size	Thread P	Thread T	A		B	
			mm	in	mm	in
6-8S	3/8-18	3/4-16	25,9	1.02	75,4	2.97
8-10S	1/2-14	7/8-14	31,2	1.23	90,4	3.56
12-12S	3/4-14	1 1/16-12	34,5	1.36	104,6	4.12
16-16S	1-11 1/2	1 5/16-12	41,1	1.62	117,8	4.64

Note: Available without O-Ring. Order by Part no. 206804-1-(Dash size).

Pipe to braze and weld

Braze port/external pipe

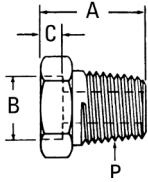

Part no. 73056-(Dash size)

Dash size	Tube O.D.		Thread P	A		B		C	
	mm	in		mm	in	mm	in	mm	in
16S	25,4	1.00	1-11 1/2	33,6	1.32	25,4	1.00	6,4	0.25

Braze port/external pipe

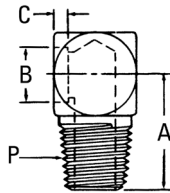

Part no. FF1159-(Dash size)

Dash size	Tube O.D.		Thread P	A		B		C	
	mm	in		mm	in	mm	in	mm	in
0406S	9,6	0.38	1/4-18	22,9	0.90	9,7	0.38	4,0	0.16
2020S	31,7	1.25	1 1/4-11 1/2	59,7	2.35	31,8	1.25	6,4	0.25

SAE 37° (JIC) flare union

Union 37° flare/37° flare

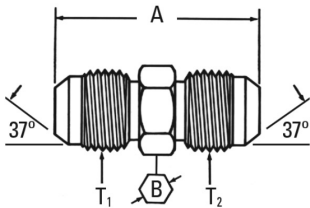

Part no. 2027-(Dash size) (Ref. SAE 070101)

Dash size	Tube O.D.		Thread T1	Thread T2	A		B	
	mm	in			mm	in	mm	in
2-2S	3,3	0.13	5/16-24	5/16-24	29,7	1.17	11,2	0.44
3-3S	4,8	0.19	3/8-24	3/8-24	31,2	1.23	11,2	0.44
4-3S	4,8	0.19	7/16-20	3/8-24	33,0	1.30	12,7	0.50
4-4S	6,3	0.25	7/16-20	7/16-20	34,8	1.37	12,7	0.50
5-4S	6,3	0.25	1/2-20	7/16-20	34,8	1.37	14,2	0.56
5-5S	7,9	0.31	1/2-20	1/2-20	34,8	1.37	14,2	0.56
6-4S	6,3	0.25	9/16-18	7/16-20	35,6	1.40	15,7	0.62
6-5S	7,9	0.31	9/16-18	1/2-20	35,6	1.40	15,7	0.62
6-6S	9,6	0.38	9/16-18	9/16-18	35,8	1.41	15,7	0.62
8-4S	6,3	0.25	3/4-16	7/16-20	38,4	1.51	20,6	0.81
8-6S	9,6	0.38	3/4-16	9/16-18	38,6	1.52	20,6	0.81
8-8S	12,7	0.50	3/4-16	3/4-16	41,1	1.62	20,6	0.81
10-6S	9,6	0.38	7/8-14	9/16-18	42,7	1.68	23,9	0.94
10-8S	12,7	0.50	7/8-14	3/4-16	45,2	1.78	23,9	0.94
10-10S	16,0	0.63	7/8-14	7/8-14	47,8	1.88	23,9	0.94
12-8S	9,6	0.38	1 1/16-12	3/4-16	49,5	1.95	28,4	1.12
12-10S	15,5	0.61	1 1/16-12	7/8-14	52,1	2.05	28,4	1.12
12-12S	19,0	0.75	1 1/16-12	1 1/16-12	54,9	2.16	28,4	1.12
14-14S	21,1	0.83	1 3/16-12	1 3/16-12	56,1	2.21	31,8	1.25
16-12S	19,0	0.75	1 5/16-12	1 1/16-12	55,9	2.20	35,1	1.38
16-16S	25,4	1.00	1 5/16-12	1 5/16-12	57,2	2.25	35,1	1.38
20-16S	25,4	1.00	1 5/8-12	1 5/16-12	60,5	2.38	42,7	1.68
20-20S	31,7	1.25	1 5/8-12	1 5/8-12	61,7	2.43	42,9	1.69
24-24S	38,1	1.50	1 7/8-12	1 7/8-12	69,9	2.75	50,8	2.00
32-32S	50,8	2.00	2 1/2-12	2 1/2-12	86,4	3.40	66,5	2.62

Note: Also available in stainless steel as Part no. 259-2027.

Adapters and tube fittings

SAE 37° (JIC) flare union

J

SAE 37° (JIC) flare union

37° flare/37° flare (large hex)

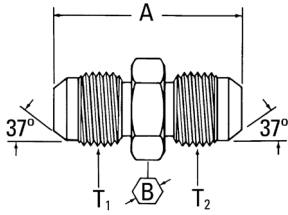

Part no. 202712-(Dash size) (Ref. SAE 070119)

Dash size	Tube O.D.		Thread T1	Thread T2	A		B	
	mm	in			mm	in	mm	in
5-5S	7,9	0.31	1/2-20	1/2-20	34,8	1.37	19,0	0.75
6-4S	6,3	0.25	9/16-18	7/16-20	35,6	1.40	20,6	0.81
6-5S	7,9	0.31	9/16-18	1/2-20	35,6	1.40	20,6	0.81
8-8S	12,7	0.50	3/4-16	3/4-16	41,1	1.62	25,4	1.00
10-8S	12,7	0.50	7/8-14	3/4-16	45,2	1.78	28,5	1.12
10-10S	16,0	0.63	7/8-14	7/8-14	47,7	1.88	28,5	1.12
12-10S	16,0	0.63	1 1/16-12	7/8-14	52,0	2.05	35,1	1.38
12-12S	19,0	0.75	1 1/16-12	1 1/16-12	54,9	2.16	35,1	1.38
16-16S	25,4	1.00	1 5/16-12	1 5/16-12	57,2	2.25	41,1	1.62

37° flare bulkhead/37° flare

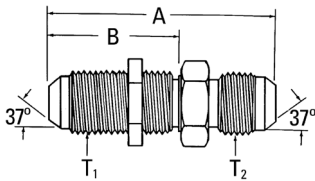

Part no. 2041-(Dash size) (Ref. SAE 070601)

Dash size	Tube O.D.		Thread T1	Thread T2	A		B	
	mm	in			mm	in	mm	in
3-3S	4,80	0.19	3/8-24	3/8-24	48,3	1.9	29,0	1.14
4-4S	6,3	0.25	7/16-20	7/16-20	52,6	2.07	31,2	1.23
4-6S	9,6	0.38	7/16-20	9/16-18	53,3	2.10	31,2	1.23
5-5S	7,9	0.31	1/2-20	1/2-20	52,6	2.07	31,2	1.23
6-6S	9,6	0.38	9/16-18	9/16-18	55,4	2.18	33,3	1.31
8-8S	12,7	0.50	3/4-16	3/4-16	62,0	2.44	37,3	1.47
10-10S	16,0	0.63	7/8-14	7/8-14	69,6	2.74	40,9	1.61
12-12S	19,0	0.75	1 1/16-12	1 1/16-12	78,5	3.09	45,2	1.78
12-16S	25,4	1.00	1 1/16-12	1 5/16-12	79,8	3.14	45,2	1.78
16-16S	25,4	1.00	1 5/16-12	1 5/16-12	79,8	3.14	45,2	1.78
20-20S	31,7	1.25	1 5/8-12	1 5/8-12	84,1	3.31	46,5	1.83
24-24S	38,1	1.50	1 7/8-12	1 7/8-12	89,4	3.52	46,7	1.84

Note: Available without nut. Order by Part no. 2041-1-(Dash size).

37° flare plug

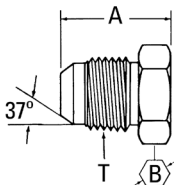

Part no. 900599-(Dash size) (Ref. SAE 070109)

Dash size	Tube O.D.		Thread T1	A		B	
	mm	in		mm	in	mm	in
3S	4,8	0.19	3/8-24	18,5	0.73	11,2	0.44
4S	6,3	0.25	7/16-20	20,3	0.80	12,7	0.50
5S	7,9	0.31	1/2-20	20,3	0.80	14,2	0.56
6S	9,6	0.38	9/16-18	21,3	0.84	15,7	0.62
8S	12,7	0.50	3/4-16	23,9	0.94	20,6	0.81
10S	16,0	0.63	7/8-14	27,9	1.10	23,9	0.94
12S	19,0	0.75	1 1/16-12	32,5	1.28	28,4	1.12
16S	25,4	1.00	1 5/16-12	33,8	1.33	35,1	1.38
20S	31,7	1.25	1 5/8-12	36,8	1.45	42,9	1.69
24S	38,1	1.50	1 7/8-12	41,9	1.65	50,8	2.00
32S	50,8	2.00	2 1/2-12	52,1	2.05	66,5	2.62

SAE 37° (JIC) flare union

Cap nut

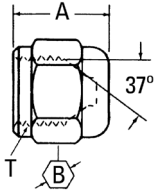

Part no. 210292-(Dash size) (Ref. SAE 070112)

Dash size	Tube O.D.		Thread T	A		B	
	mm	in		mm	in	mm	in
3S	4,8	0.19	3/8-24	14,2	0.56	11,2	0.44
4S	6,3	0.25	7/16-20	15,0	0.59	14,2	0.56
5S	7,9	0.31	1/2-20	15,5	0.61	15,7	0.62
6S	9,6	0.38	9/16-18	15,7	0.62	17,6	0.69
8S	12,7	0.50	3/4-16	19,0	0.75	22,4	0.88
10S	16,0	0.63	7/8-14	21,3	0.84	25,4	1.00
12S	19,0	0.75	1 1/16-12	23,1	0.91	31,8	1.25
16S	25,4	1.00	1 5/16-12	25,9	1.02	38,1	1.50
20S	31,7	1.25	1 5/8-12	26,9	1.06	50,8	2.00
24S	38,1	1.50	1 7/8-12	30,3	1.19	57,2	2.25
32S	50,8	2.00	2 1/2-12	36,6	1.44	73,1	2.88

*Also available in stainless steel at 259-210292-(dash size)

37° flare (internal)/37° flare

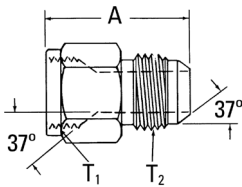

Part no. 2215-(Dash size)

Dash size	Tube O.D.		Thread T1	Thread T2	A	
	mm	in			mm	in
4-6S	9,6	0.38	9/16-18	7/16-20	31,8	1.25
6-5S	7,9	0.31	9/16-18	1/2-20	30,0	1.18
8-10S	16,0	0.63	3/4-16	7/8-14	38,4	1.51
10-4S	6,3	0.25	7/8-14	7/16-20	35,6	1.40
10-6S	9,6	0.38	7/8-14	9/16-18	35,8	1.41
10-8S	12,7	0.50	7/8-14	3/4-16	38,9	1.53
10-12S	19,0	0.75	7/8-14	1 1/16-12	44,2	1.74
12-10S	16,0	0.63	1 1/16-12	7/8-14	43,9	1.73
12-16S	25,4	1.00	1 1/16-12	1 5/16-12	50,8	2.00
14-8S	12,7	0.50	1 3/16-12	3/4-16	42,9	1.69
16-8S	12,7	0.50	1 5/16-12	3/4-16	42,4	1.67
16-10S	16,0	0.63	1 5/16-12	7/8-14	45,2	1.78
16-20S	31,8	1.25	1 5/16-12	1 5/8-12	58,4	2.30
20-16S	25,4	1.00	1 5/8-12	1 5/16-12	50,3	1.98
24-16S	25,4	1.00	1 7/8-12	1 5/16-12	58,7	2.31
24-20S	31,8	1.25	1 7/8-12	1 5/8-12	58,4	2.30
24-32S	50,8	2.00	1 7/8-12	2 1/2-12	68,1	2.68
32-24S	38,1	1.50	2 1/2-12	1 7/8-12	64,0	2.52

Adapters and tube fittings

SAE 37° (JIC) flare union

J

SAE 37° (JIC) flare union

37° flare swivel reducer/37° flare

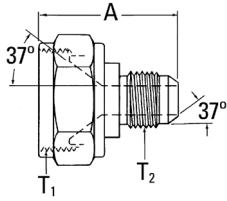

Part no. 221501-(Dash size) (Ref. SAE 070123)

Dash size	Tube O.D.		Thread T1	Thread T2	A	
	mm	in			mm	in
6-4S	6,3	0.25	9/16-18	7/16-20	35,6	1.40
8-4S	6,3	0.25	3/4-16	7/16-20	38,1	1.50
8-6S	9,6	0.38	3/4-16	9/16-18	38,1	1.50
10-6S	9,6	0.38	7/8-14	9/16-18	41,1	1.62
12-6S	9,6	0.38	1 1/16-12	9/16-18	42,9	1.69
12-8S	12,7	0.50	1 1/16-12	3/4-16	45,5	1.79
16-6S	9,6	0.38	1 5/16-12	9/16-18	46,7	1.84
16-8S	12,7	0.50	1 5/16-12	3/4-16	49,3	1.94
16-10S	16,0	0.63	1 5/16-12	7/8-14	51,8	2.04
16-12S	19,0	0.75	1 5/16-12	1 1/16-12	54,6	2.15
20-16S	25,4	1.00	1 5/8-12	1 5/16-12	56,6	2.23

Note: Available without nut. Order by Part no. FF1066-(Dash size).

37° flare bulkhead/37° flare

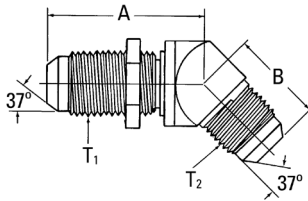

Part no. 2042-(Dash size) (Ref. SAE 070801)

Dash size	Tube O.D.		Thread T1	Thread T2	A		B	
	mm	in			mm	in	mm	in
3-3S	4,8	0.19	3/8-24	3/8-24	35,1	1.38	18,3	0.72
4-4S	6,3	0.25	7/16-20	7/16-20	38,9	1.53	18,3	0.72
5-5S	7,9	0.31	1/2-20	1/2-20	42,2	1.66	19,6	0.77
6-6S	9,6	0.38	9/16-18	9/16-18	42,4	1.67	21,1	0.83
8-8S	12,7	0.50	3/4-16	3/4-16	49,3	1.94	24,9	0.98
10-10S	16,0	0.63	7/8-14	7/8-14	55,1	2.17	28,2	1.11
20-20S	31,7	1.25	1 5/8-12	1 5/8-12	64,3	2.53	42,9	1.69

Note: Available without nut. Order by part no. 2042-1-(Dash size).

37° flare swivel/37° flare

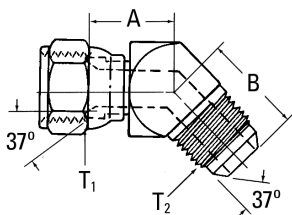

Part no. 2070-(Dash size) (Ref. SAE 070321)

Dash size	Tube O.D.		Thread T1	Thread T2	A		B	
	mm	in			mm	in	mm	in
4-4S	6,3	0.25	7/16-20	7/16-20	15,2	0.60	18,3	0.72
5-5S	7,9	0.31	1/2-20	1/2-20	15,7	0.62	19,6	0.77
6-6S	9,6	0.38	9/16-18	9/16-18	18,8	0.74	21,1	0.83
8-8S	12,7	0.50	3/4-16	3/4-16	21,8	0.86	24,9	0.98
10-10S	16,0	0.63	7/8-14	7/8-14	23,9	0.94	28,2	1.11
12-12S	19,0	0.75	1 1/16-12	1 1/16-12	23,9	0.94	32,5	1.28
14-14S	22,3	0.88	1 3/16-12	1 3/16-12	26,4	1.04	36,8	1.45
16-16S	25,4	1.00	1 5/16-12	1 5/16-12	29,5	1.16	37,3	1.47
20-20S	31,7	1.25	1 5/8-12	1 5/8-12	35,6	1.40	40,4	1.59

SAE 37° (JIC) flare union

37° flare/37° flare

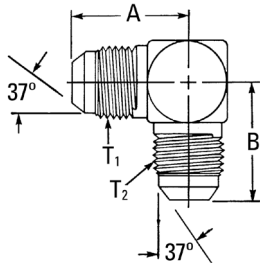

Part no. 2039-(Dash size) (Ref. SAE 070201)

Dash size	Tube O.D.		Thread T1	Thread T2	A		B	
	mm	in			mm	in	mm	in
4-4S	6,3	0.25	7/16-20	7/16-20	22,6	0.89	22,6	0.89
5-5S	7,9	0.31	1/2-20	1/2-20	24,1	0.95	24,1	0.95
6-6S	9,6	0.38	9/16-18	9/16-18	26,9	1.06	26,9	1.06
8-6S	9,6	0.38	3/4-16	9/16-16	31,8	1.25	29,0	1.14
8-8S	12,7	0.50	3/4-16	3/4-16	31,8	1.25	31,8	1.25
10-10S	16,0	0.63	7/8-14	7/8-14	36,8	1.45	36,8	1.45
12-12S	19,0	0.75	1 1/16-12	1 1/16-12	42,2	1.66	42,2	1.66
16-12S	19,0	0.75	1 5/16-12	1 1/16-12	46,0	1.81	44,7	1.76
16-16S	25,4	1.00	1 5/16-12	1 5/16-12	46,0	1.81	46,0	1.81
20-20S	31,7	1.25	1 5/8-12	1 5/8-12	52,3	2.06	52,3	2.06
24-24S	38,1	1.50	1 7/8-12	1 7/8-12	59,2	2.33	59,2	2.33
32-32S	50,8	2.00	2 1/2-12	2 1/2-12	77,7	3.06	77,7	3.06

37° flare bulkhead/37° flare

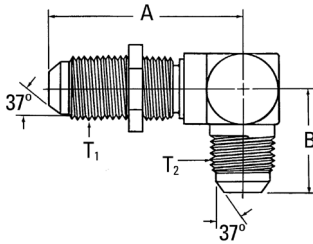

Part no. 2043-(Dash size) (Ref. SAE 070701)

Dash size	Tube O.D.		Thread T1	Thread T2	A		B	
	mm	in			mm	in	mm	in
3-3S	4,8	0.19	3/8-24	3/8-24	38,1	1.50	23,9	0.94
4-4S	6,3	0.25	7/16-20	7/16-20	40,4	1.59	24,6	0.97
5-5S	7,9	0.31	1/2-20	1/2-20	43,7	1.72	26,9	1.06
6-6S	9,6	0.38	9/16-18	9/16-18	46,0	1.81	27,7	1.09
8-8S	12,7	0.50	3/4-16	3/4-16	53,6	2.11	34,5	1.36
10-10S	16,0	0.63	7/8-14	7/8-14	60,7	2.39	39,6	1.56
12-12S	19,0	0.75	1 1/16-12	1 1/16-12	67,8	2.67	45,2	1.78
16-16S	25,4	1.00	1 5/16-12	1 5/16-12	71,1	2.80	49,3	1.94

Note: Available without nut. Order by part no. 2043-1-1-(Dash size).

37° flare swivel/37° flare

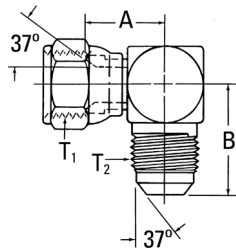

Part no. 2071-(Dash size) (Ref. SAE 070221)

Dash size	Tube O.D.		Thread T1	Thread T2	A		B	
	mm	in			mm	in	mm	in
4-4S	6,3	0.25	7/16-20	7/16-20	16,8	0.66	22,6	0.89
4-6S	9,6	0.38	7/16-20	9/16-18	20,8	0.82	26,9	1.06
5-5S	7,9	0.31	1/2-20	1/2-20	17,3	0.68	24,1	0.95
6-4S	6,3	0.25	9/16-18	7/16-20	22,4	0.88	26,7	1.05
6-6S	9,6	0.38	9/16-18	9/16-18	22,4	0.88	26,9	1.06
8-6S	9,6	0.38	3/4-16	9/16-18	24,4	0.96	29,0	1.14
8-8S	12,7	0.50	3/4-16	3/4-16	24,4	0.96	31,8	1.25
8-10S	16,0	0.63	3/4-16	7/8-14	25,4	1.00	36,8	1.45
10-8S	12,7	0.50	7/8-14	3/4-16	28,4	1.12	33,8	1.33
10-10S	16,0	0.63	7/8-14	7/8-14	28,4	1.12	36,8	1.45
12-12S	19,0	0.75	1 1/16-12	1 1/16-12	30,2	1.19	42,2	1.66
14-14S	22,3	0.88	1 3/16-12	1 3/16-12	30,5	1.20	45,7	1.80
16-16S	25,4	1.00	1 5/16-12	1 5/16-12	35,8	1.41	46,0	1.81
20-20S	31,7	1.25	1 5/8-12	1 5/8-12	42,7	1.68	52,3	2.06
24-24S	38,1	1.50	1 7/8-12	1 7/8-12	47,2	1.86	59,2	2.33
32-32S	50,8	2.00	2 1/2-12	2 1/2-12	62,0	2.44	77,7	3.06

Adapters and tube fittings

SAE 37° (JIC) flare union

J

SAE 37° (JIC) flare union

37° flare swivel/37° flare

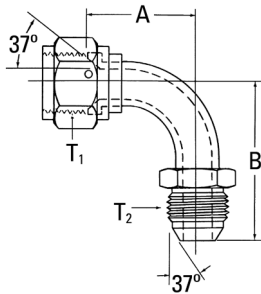

Part no. FF5163-(Dash size)

Dash size	Tube O.D.		Thread T1	Thread T2	A		B	
	mm	in			mm	in	mm	in
0808S	12,7	0.50	3/4-16	3/4-16	47,5	1.87	54,9	2.16
1212S	19,0	0.75	1 1/16-12	1 1/16-12	59,7	2.35	71,4	2.81
1616S	25,4	1.00	1 5/16-12	1 5/16-12	77,2	3.04	86,6	3.41
2020S	31,7	1.25	1 5/8-12	1 5/8-12	86,4	3.40	94,2	3.71
2424S	38,1	1.50	1 7/8-12	1 7/8-12	100,3	3.95	110,0	4.33

37° flare swivel/37° flare

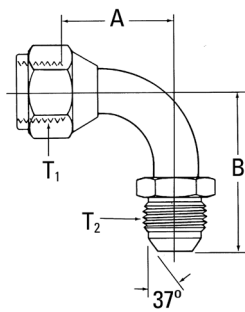

Part no. 500454-(Dash size)

Dash size	Tube O.D.		Thread T1	Thread T2	A		B	
	mm	in			mm	in	mm	in
4S	6,3	0.25	7/16-20	7/16-20	17,3	0.68	28,5	1.12
5S	7,9	0.31	1/2-20	1/2-20	19,5	0.77	31,5	1.24
6S	9,6	0.38	9/16-18	9/16-18	21,6	0.85	33,3	1.31
8S	12,7	0.50	3/4-16	3/4-16	27,7	1.09	42,2	1.66
10S	16,0	0.63	7/8-14	7/8-14	31,2	1.23	46,2	1.82
12S	19,0	0.75	1 1/16-12	1 1/16-12	46,2	1.82	63,2	2.49
16S	25,4	1.00	1 5/16-12	1 5/16-12	60,7	2.39	70,9	2.79
20S	31,7	1.25	1 5/8-12	1 5/8-12	69,8	2.75	79,7	3.14

37° flare swivel/37° flare

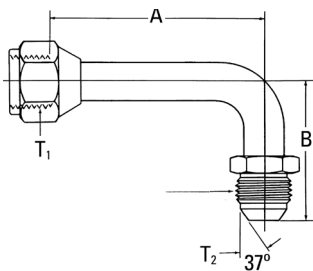

Part no. 504095-(Dash size)

Dash size	Tube O.D.		Thread T1	Thread T2	A		B	
	mm	in			mm	in	mm	in
4S	6,3	0.25	7/16-20	7/16-20	45,7	1.80	28,5	1.12
5S	7,9	0.31	1/2-20	1/2-20	44,9	1.77	31,5	1.24
6S	9,6	0.38	9/16-18	9/16-18	55,4	2.18	33,3	1.31
8S	12,7	0.50	3/4-16	3/4-16	61,7	2.43	45,2	1.78
10S	16,0	0.63	7/8-14	7/8-14	65,3	2.57	52,6	2.07
12S	19,0	0.75	1 1/16-12	1 1/16-12	94,7	3.73	63,2	2.49
16S	25,4	1.00	1 5/16-12	1 5/16-12	116,3	4.58	70,9	2.79
20S	31,7	1.25	1 5/8-12	1 5/8-12	140,5	5.53	79,7	3.14

SAE 37° (JIC) flare union

37° flare swivel/37° flare

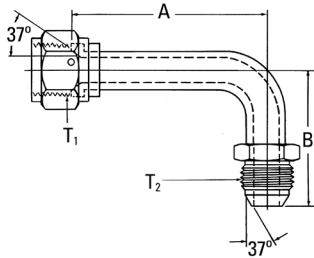

Part no. FF5164-(Dash size)

Dash size	Tube O.D.		Thread T1	Thread T2	A		B	
	mm	in			mm	in	mm	in
0808S	12,7	0.50	3/4-16	3/4-16	84,8	3.34	54,9	2.16
1212S	19,0	0.75	1 1/16-12	1 1/16-12	112,0	4.41	71,4	2.81
1616S	25,4	1.00	1 5/16-12	1 5/16-12	133,1	5.24	86,6	3.41
2020S	31,7	1.25	1 5/8-12	1 5/8-12	164,6	6.48	94,2	3.71

37° flare/37° flare/37° flare

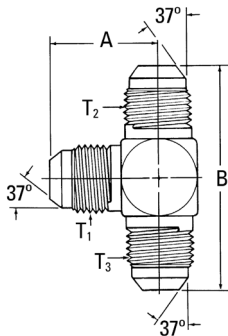

Part no. 2033-(Dash size) (Ref. SAE 070401)

Dash size	Tube O.D.		Thread T1	Thread T2	Thread T3	A		B	
	mm	in				mm	in	mm	in
4-4S	6,3	0.25	7/16-20	7/16-20	7/16-20	22,6	0.89	45,2	1.78
5-5S	7,9	0.31	1/2-20	1/2-20	1/2-20	24,1	0.95	48,3	1.90
6-4-4S	6,3	0.25	9/16-18	7/16-20	7/16-20	26,9	1.06	53,3	2.10
6-6S	9,6	0.38	9/16-18	9/16-18	9/16-18	26,9	1.06	53,8	2.12
8-6-6S	9,6	0.38	3/4-16	9/16-18	9/16-18	31,8	1.25	57,9	2.28
8-8S	12,7	0.50	3/4-16	3/4-16	3/4-16	31,8	1.25	63,5	2.50
8-12-12S	19,0	0.75	3/4-16	1 1/16-12	1 1/16-12	36,1	1.42	84,3	3.32
10-10S	16,0	0.63	7/8-14	7/8-14	7/8-14	36,8	1.45	73,7	2.90
12-12S	19,0	0.75	1 1/16-12	1 1/16-12	1 1/16-12	42,2	1.66	84,3	3.32
12-12-16S	19,0	0.75	1 1/16-12	1 1/16-12	1 5/16-12	44,7	1.76	92,7	3.65
16-16S	25,4	1.00	1 5/16-12	1 5/16-12	1 5/16-12	46,0	1.81	91,9	3.62
16-16-20S	31,7	1.25	1 5/16-12	1 5/16-12	1 5/8-12	50,8	2.00	103,1	4.06
20-16-16S	25,4	1.00	1 5/8-12	1 5/16-12	1 5/16-12	52,3	2.06	102,1	4.02
20-20S	31,7	1.25	1 5/8-12	1 5/8-12	1 5/8-12	52,3	2.06	104,6	4.12
24-24S	38,1	1.50	1 7/8-12	1 7/8-12	1 7/8-12	59,2	2.33	118,4	4.66

37° flare bulkhead/37° flare

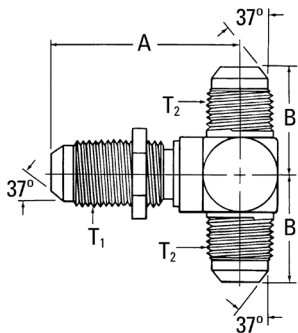

Part no. 203002-(Dash size) (Ref. SAE 070959)

Dash size	Tube O.D.		Thread T1	Thread T2	A		B	
	mm	in			mm	in	mm	in
4-4S	6,3	0.25	7/16-20	7/16-20	40,4	1.59	24,6	0.97
5-5S	7,9	0.31	1/2-20	1/2-20	43,7	1.72	26,9	1.06
6-6S	9,6	0.38	9/16-18	9/16-18	46,0	1.81	27,7	1.09
8-8S	12,7	0.50	3/4-16	3/4-16	53,6	2.11	34,5	1.36
10-10S	16,0	0.63	7/8-14	7/8-14	60,7	2.39	39,6	1.56
12-12S	19,0	0.75	1 1/16-12	1 1/16-12	67,8	2.67	45,2	1.78
16-16S	25,4	1.00	1 5/16-12	1 5/16-12	71,1	2.80	49,3	1.94

Note: Available without nut. Order by Part no. 203002-1-(Dash size).

Adapters and tube fittings

SAE 37° (JIC) flare union

J

SAE 37° (JIC) flare union

37° flare bulkhead/37° flare

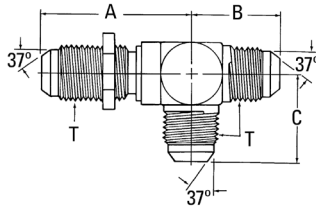

Part no. 203008-(Dash size) (Ref. SAE 070958)

Dash size	Tube O.D.		Thread T	A		B		C	
	mm	in		mm	in	mm	in	mm	in
3-3S	4,80	0.19	3/8/24	38,1	1.50	23,9	0.94	23,9	0.94
6-6S	9,6	0.38	9/16-18	46,0	1.81	27,7	1.09	27,7	1.09
8-8S	12,7	0.50	3/4-16	53,6	2.11	34,5	1.36	34,5	1.36
10-10S	16,0	0.63	7/8-14	60,7	2.39	39,6	1.56	39,6	1.56
12-12S	19,0	0.75	1 1/16-12	67,8	2.67	45,2	1.78	45,2	1.78
16-16S	25,4	1.00	1 5/16-12	71,1	2.80	49,3	1.94	49,3	1.94
20-20S	31,7	1.25	1 5/8-12	79,2	3.12	55,1	2.17	55,1	2.17

Note: Available without nut. Order by Part no. FF1065-(Dash size).

37° flare swivel/37° flare

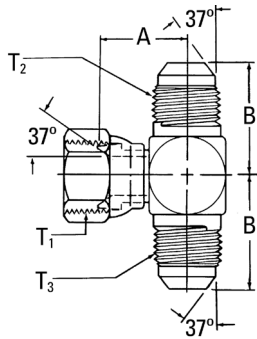

Part no. 203101-(Dash size) (Ref. SAE 070433)

Dash size	Tube O.D.		Thread T	Thread T2	Thread T3	A		B	
	mm	in				mm	in	mm	in
4-4S	6,3	0.25	7/16-20	7/16-20	7/16-20	16,8	0.66	22,6	0.89
5-5S	7,9	0.31	1/2-20	1/2-20	1/2-20	17,3	0.68	24,1	0.95
6-5S	7,9	0.31	9/16-18	9/16-18	9/16-18	22,4	0.88	26,7	1.05
6-6S	9,6	0.38	9/16-18	9/16-18	9/16-18	22,4	0.88	26,9	1.06
8-8S	12,7	0.50	3/4-16	3/4-16	3/4-16	24,4	0.96	31,8	1.25
10-10S	16,0	0.63	7/8-14	7/8-14	7/8-14	28,4	1.12	36,8	1.45
12-12S	19,0	0.75	1 1/16-12	1 1/16-12	1 1/16-12	30,0	1.18	42,2	1.66
16-16S	25,4	1.00	1 5/16-12	1 5/16-12	1 5/16-12	35,6	1.40	46,0	1.81
20-20S	31,7	1.25	1 5/8-12	1 5/8-12	1 5/8-12	42,7	1.68	52,3	2.06

37° flare bulkhead/37° flare

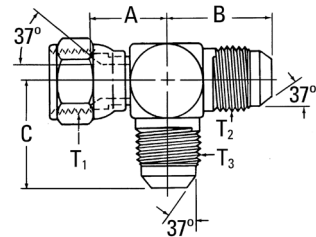

Part no. 203102-(Dash size) (Ref. SAE 070432)

Dash size	Tube O.D.		Thread T	Thread T2	Thread T3	A		B		C	
	mm	in				mm	in	mm	in	mm	in
4-4S	6,3	0.25	7/16-20	7/16-20	7/16-20	16,8	0.66	22,6	0.89	22,6	0.89
5-5S	7,9	0.31	1/2-20	1/2-20	1/2-20	17,5	0.69	24,1	0.95	24,1	0.95
6-6S	9,6	0.38	9/16-18	9/16-18	9/16-18	22,4	0.88	26,9	1.06	26,9	1.06
8-8S	12,7	0.50	3/4-16	3/4-16	3/4-16	24,4	0.96	31,8	1.25	31,8	1.25
10-10S	16,0	0.63	7/8-14	7/8-14	7/8-14	28,4	1.12	36,8	1.45	36,8	1.45
12-12S	19,0	0.75	1 1/16-12	1 1/16-12	1 1/16-12	30,2	1.19	42,2	1.66	42,2	1.66
16-16S	25,4	1.00	1 5/16-12	1 5/16-12	1 5/16-12	35,8	1.41	46,0	1.81	46,0	1.81
20-20S	31,7	1.25	1 5/8-12	1 5/8-12	1 5/8-12	42,7	1.68	52,3	2.06	52,3	2.06

SAE 37° (JIC) flare union

37° flare

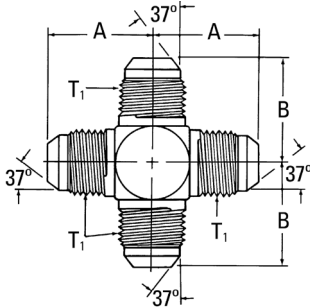

Part no. 2020-(Dash size) (Ref. SAE 070501)

Dash size	Tube O.D.		Thread T	A		B	
	mm	in		mm	in	mm	in
4-4S	6,3	0.25	7/16-20	22,6	0.89	22,6	0.89
6-6S	9,6	0.38	9/16-18	26,9	1.06	26,9	1.06
8-8S	12,7	0.50	3/4-16	31,8	1.25	31,8	1.25
12-12S	19,0	0.75	1 1/16-12	42,2	1.66	44,2	1.74
16-16S	25,4	1.00	1 5/16-12	46,0	1.81	49,8	1.96

Bulkhead lock nut

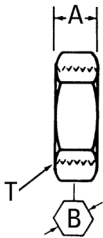

Part no. 210212-(Dash size) (Ref. SAE 070118)

Dash size	Tube O.D.		Thread T	A		B	
	mm	in		mm	in	mm	in
4S	6,3	0.25	7/16-20	6,4	0.25	17,6	0.69
5S	7,9	0.31	1/2-20	6,4	0.25	19,0	0.75
6S	9,6	0.38	9/16-18	6,8	0.27	20,6	0.81
8S	12,7	0.50	3/4-16	7,9	0.31	25,4	1.00
10S	16,0	0.63	7/8-14	9,1	0.36	28,5	1.12
12S	19,0	0.75	1 1/16-12	10,4	0.41	35,1	1.38
16S	25,4	1.00	1 5/16-12	10,4	0.41	41,1	1.62
20S	31,7	1.25	1 5/8-12	10,4	0.41	47,7	1.88
24S	38,1	1.50	1 7/8-12	10,4	0.41	53,9	2.12

SAE 45° flare union

SAE 45° flare bulkhead/45° flare

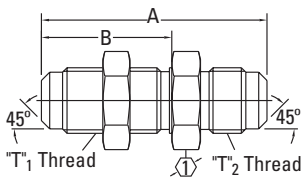

Part no. 2056-(Dash size)

Dash size	Tube O.D.		Thread T1	Thread T2	A		B		1	
	mm	in			mm	in	mm	in	mm	in
10-10S	16,0	0.63	7/8-14	7/8-14	75,9	2.99	43,9	1.73	28,5	1.12

Note: Note: Available without nut. Order by Part no. 2056-1-(Dash size).

45° flare/45° flare

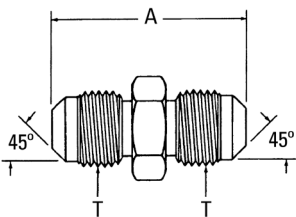

Part no. 2060-(Dash size) (Ref. SAE 010101)

Dash size	Tube O.D.		Thread T	A
	mm	in		mm in
4-4B	6,3	0.25	7/16-20	30,3 1.19
5-5B	7,9	0.31	1/2-20	34,0 1.34
6-6B	9,6	0.38	5/8-18	38,1 1.50
8-8B	12,7	0.50	3/4-16	46,0 1.81
10-10B	16,0	0.63	7/8-14	53,9 2.12
12-12B	19,0	0.75	1 1/16-14	62,0 2.44

Adapters and tube fittings

SAE O-Ring boss to 37° flare

J

SAE O-Ring boss to 37° flare

SAE O-Ring boss/37° flare

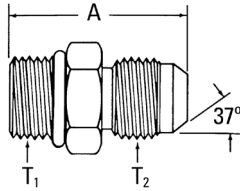

Part no. 202702-(Dash size) (Ref. SAE 070120)

Dash size	Tube O.D.		Thread T1	Thread T2	A	
	mm	in			mm	in
2-2S	3,3	0.13	5/16-24	5/16-24	26,9	1.06
3-3S	4,8	0.19	3/8-24	3/8-24	27,9	1.10
4-4S	6,3	0.25	7/16-20	7/16-20	31,2	1.23
4-5S	7,9	0.31	7/16-20	1/2-20	31,2	1.23
4-6S	9,6	0.38	7/16-20	9/16-18	32,3	1.27
4-8S	12,7	0.50	7/16-20	3/4-16	37,8	1.49
5-4S	6,3	0.25	1/2-20	7/16-20	31,2	1.23
5-5S	7,9	0.31	1/2-20	1/2-20	31,2	1.23
5-6S	9,6	0.38	1/2-20	9/16-18	32,3	1.27
6-4S	6,3	0.25	9/16-18	7/16-20	32,8	1.29
6-5S	7,9	0.31	9/16-18	1/2-20	32,8	1.29
6-6S	9,6	0.38	9/16-18	9/16-18	33,0	1.30
6-8S	12,7	0.50	9/16-18	3/4-16	36,6	1.44
6-10S	16,0	0.63	9/16-18	7/8-14	43,4	1.71
8-4S	6,3	0.25	3/4-16	7/16-20	34,8	1.37
8-5S	7,9	0.31	3/4-16	1/2-20	34,8	1.37
8-6S	9,6	0.38	3/4-16	9/16-18	35,1	1.38
8-8S	12,7	0.50	3/4-16	3/4-16	37,6	1.48
8-10S	16,0	0.63	3/4-16	7/8-14	41,7	1.64
8-12S	19,0	0.75	3/4-16	1 1/16-12	49,3	1.94
10-4S	6,3	0.25	7/8-14	7/16-20	37,8	1.49
10-6S	9,6	0.38	7/8-14	9/16-18	38,1	1.50
10-8S	12,7	0.50	7/8-14	3/4-16	40,6	1.60
10-10S	16,0	0.63	7/8-14	7/8-14	43,2	1.70
10-12S	19,0	0.75	7/8-14	1 1/16-12	47,8	1.88
10-16S	25,4	1.00	7/8-14	1 5/16-12	52,6	2.07
12-6S	9,6	0.38	1 1/16-12	9/16-18	42,2	1.66
12-8S	12,7	0.50	1 1/16-12	3/4-16	44,7	1.76
12-10S	16,0	0.63	1 1/16-12	7/8-14	47,2	1.86
12-12S	19,0	0.75	1 1/16-12	1 1/16-12	50,0	1.97
12-14S	22,3	0.88	1 1/16-12	1 3/16-12	50,5	1.99
12-16S	25,4	1.00	1 1/16-12	1 5/16-12	51,8	2.04
12-20S	31,7	1.25	1 1/16-12	1 5/8-12	58,4	2.30
14-10S	16,0	0.63	1 3/16-12	7/8-14	47,2	1.86
14-12S	19,0	0.75	1 3/16-12	1 1/16-12	49,8	1.96
14-14S	22,3	0.88	1 3/16-12	1 3/16-12	50,5	1.99
14-16S	25,4	1.00	1 3/16-12	1 5/16-12	51,8	2.04
16-8S	12,7	0.50	1 5/16-12	3/4-16	45,5	1.79
16-10S	16,0	0.63	1 5/16-12	7/8-14	48,0	1.89
16-12S	19,0	0.75	1 5/16-12	1 1/16-12	50,5	1.99
16-16S	25,4	1.00	1 5/16-12	1 5/16-12	51,8	2.04
16-20S	31,7	1.25	1 5/16-12	1 5/8-12	59,2	2.33
20-12S	19,0	0.75	1 5/8-12	1 1/16-12	52,8	2.08

Available without O-ring. Order by Part No. 202701-(Dash size).
Also available in stainless steel as part no. 259-202702.

(continued next page)

SAE O-Ring boss to 37° flare

SAE O-Ring boss/37° flare
(continued)

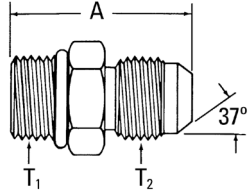

Part no. 202702-(Dash size) Continued (Ref. SAE 070120)

Dash size	Tube O.D.		Thread T1	Thread T2	A	
	mm	in			mm	in
20-16S	25,4	1.00	1 5/8-12	1 5/16-12	53,8	2.12
20-20S	31,7	1.25	1 5/8-12	1 5/8-12	55,1	2.17
20-24S	38,1	1.50	1 5/8-12	1 7/8-12	64,3	2.53
24-16S	25,4	1.00	1 7/8-12	1 5/16-12	55,9	2.20
24-20S	31,7	1.25	1 7/8-12	1 5/8-12	56,9	2.24
24-24S	38,1	1.50	1 7/8-12	1 7/8-12	60,2	2.37
32-32S	50,8	2.00	2 1/2-12	2 1/2-12	70,6	2.78

Available without O-ring. Order by Part No. 202701-(Dash size).

Also available in stainless steel as part no. 259-202702.

SAE O-Ring boss/37° flare

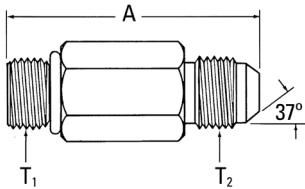

Part no. 202713-(Dash size)

Dash size	Tube O.D.		Thread T1	Thread T2	A	
	mm	in			mm	in
4-4S	6,3	0.25	7/16-20	7/16-20	52,8	2.08
6-6S	9,6	0.38	9/16-18	9/16-18	58,7	2.31
8-8S	12,7	0.50	3/4-16	3/4-16	68,6	2.70
10-10S	16,0	0.63	7/8-14	7/8-14	77,2	3.04
12-12S	19,0	0.75	1 1/16-12	1 1/16-12	91,7	3.61
16-16S	25,4	1.00	1 5/16-12	1 5/16-12	101,1	3.98

SAE O-Ring boss/37° flare swivel

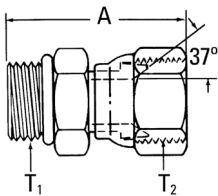

Part no. 2266-(Dash size)

Dash size	Tube O.D.		Thread T1	Thread T2	A	
	mm	in			mm	in
4-4S	6,4	0.25	7/16-20	7/16-20	32,6	1.28
6-6S	9,6	0.38	9/16-18	3/4-16	35,6	1.40
6-8S	12,7	0.50	9/16-18	3/4-16	41,4	1.63
8-8S	12,7	0.50	3/4-16	3/4-16	39,4	1.55
10-10S	16,0	0.63	7/8-14	7/8-14	43,7	1.72
12-12S	19,0	0.75	1 1/16-12	1 1/16-12	48,3	1.90
16-16S	25,4	1.00	1 5/16-12	1 5/16-12	53,6	2.11
20-20S	31,7	1.25	1 5/8-12	1 5/8-12	64,5	2.54

Adapters and tube fittings

SAE O-Ring boss to 37° flare

J

SAE O-Ring boss to 37° flare

SAE O-Ring boss (adj.)/37° flare

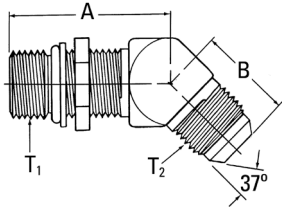

Part no. 2061-(Dash size) (Ref. SAE 070320)

Dash size	Tube O.D.		Thread T1	Thread T2	A		B	
	mm	in			mm	in	mm	in
4-4S	6,3	0.25	7/16-20	7/16-20	26,7	1.05	18,3	0.72
6-4S	6,3	0.25	9/16-18	7/16-20	29,0	1.14	20,8	0.82
6-6S	9,6	0.38	9/16-18	9/16-18	29,0	1.14	21,1	0.83
6-8S	12,7	0.50	9/16-18	3/4-16	30,5	1.20	24,9	0.98
8-6S	9,6	0.38	3/4-16	9/16-18	33,0	1.30	22,1	0.87
8-8S	12,7	0.50	3/4-16	3/4-16	33,0	1.30	24,9	0.98
8-10S	16,0	0.63	3/4-16	7/8-14	34,5	1.36	28,2	1.11
10-8S	12,7	0.50	7/8-14	3/4-16	38,6	1.52	25,1	0.99
10-10S	16,0	0.63	7/8-14	7/8-14	38,6	1.52	28,2	1.11
10-12S	19,0	0.75	7/8-14	1 1/16-12	39,9	1.57	32,5	1.28
12-8S	12,7	0.50	1 1/16-12	3/4-16	43,9	1.73	26,4	1.04
12-10S	16,0	0.63	1 1/16-12	7/8-14	43,9	1.73	29,5	1.16
12-12S	19,0	0.75	1 1/16-12	1 1/16-12	43,9	1.73	32,5	1.28
12-16S	25,4	1.00	1 1/16-12	1 5/16-12	47,2	1.86	37,3	1.47
14-14S	22,3	0.88	1 3/16-12	1 3/16-12	47,2	1.86	36,8	1.45
16-12S	19,0	0.75	1 5/16-12	1 1/16-12	47,2	1.86	36,1	1.42
16-16S	25,4	1.00	1 5/16-12	1 5/16-12	47,2	1.86	37,3	1.47
16-20S	31,7	1.25	1 5/16-12	1 5/8-12	48,5	1.91	40,4	1.59
20-16S	25,4	1.00	1 5/8-12	1 5/16-12	48,5	1.91	39,1	1.54
20-20S	31,7	1.25	1 5/8-12	1 5/8-12	48,5	1.91	40,4	1.59

SAE O-Ring flare (adj.)/37° flare

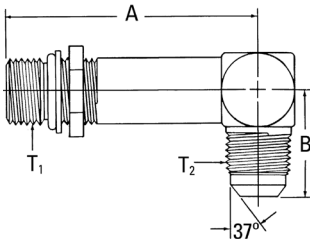

Part no. 206209-(Dash size)

Dash size	Tube O.D.		Thread T1	Thread T2	A		B	
	mm	in			mm	in	mm	in
4-4S	6,3	0.25	7/16-20	7/16-20	43,9	1.73	22,6	0.89
6-6S	9,6	0.38	9/16-18	9/16-18	52,8	2.08	26,9	1.06
8-8S	12,7	0.50	3/4-16	3/4-16	63,0	2.48	31,8	1.25
8-10S	16,0	0.63	3/4-16	7/8-14	64,0	2.52	36,8	1.45
10-8S	12,7	0.50	7/8-14	3/4-16	54,9	2.16	33,8	1.33
10-10S	16,0	0.63	7/8-14	7/8-14	73,4	2.89	36,8	1.45
12-12S	19,0	0.75	1 1/16-12	1 1/16-12	84,8	3.34	42,2	1.66
16-16S	25,4	1.00	1 5/16-12	1 5/16-12	94,5	3.72	46,0	1.81

SAE O-Ring boss to 37° flare

SAE O-Ring boss (adj.)/37° flare

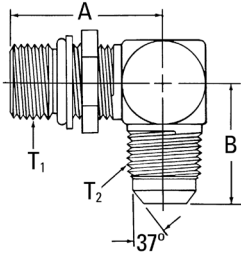

Part no. 2062-(Dash size) (Ref. SAE 070220)

Dash size	Tube O.D.		Thread T1	Thread T2	A		B	
	mm	in			mm	in	mm	in
3-6S	9,60	0.38	3/8-24	9/16-18	27,4	1.08	26,9	1.06
4-4S	6,3	0.25	7/16-20	7/16-20	26,2	1.03	22,6	0.89
4-5S	7,9	0.31	7/16-20	1/2-20	28,7	1.13	24,1	0.95
4-6S	9,6	0.38	7/16-20	9/16-18	30,2	1.19	26,9	1.06
5-4S	6,3	0.25	1/2-20	7/16-20	28,7	1.13	24,1	0.95
5-5S	7,9	0.31	1/2-20	1/2-20	28,7	1.13	24,1	0.95
5-6S	9,6	0.38	1/2-20	9/16-18	30,2	1.19	26,9	1.06
6-4S	6,3	0.25	9/16-18	7/16-20	31,8	1.25	26,7	1.05
6-5S	7,9	0.31	9/16-18	1/2-20	31,8	1.25	26,7	1.05
6-6S	9,6	0.38	9/16-18	9/16-18	31,8	1.25	26,9	1.06
6-8S	12,7	0.50	9/16-18	3/4-16	33,5	1.32	31,8	1.25
8-6S	9,6	0.38	3/4-16	9/16-18	36,8	1.45	29,0	1.14
8-8S	12,7	0.50	3/4-16	3/4-16	36,8	1.45	31,8	1.25
8-10S	16,0	0.63	3/4-16	7/8-14	39,1	1.54	36,8	1.45
8-12S	19,0	0.75	3/4-16	1 1/16-12	41,1	1.62	42,2	1.66
10-6S	9,6	0.38	7/8-14	9/16-18	43,2	1.70	31,0	1.22
10-8S	12,7	0.50	7/8-14	3/4-16	43,2	1.70	33,8	1.33
10-10S	16,0	0.63	7/8-14	7/8-14	43,2	1.70	36,8	1.45
10-12S	19,0	0.75	7/8-14	1 1/16-12	45,2	1.78	42,2	1.66
12-8S	12,7	0.50	1 1/16-12	3/4-16	49,3	1.94	36,1	1.42
12-10S	16,0	0.63	1 1/16-12	7/8-14	49,3	1.94	39,1	1.54
12-12S	19,0	0.75	1 1/16-12	1 1/16-12	49,3	1.94	42,2	1.66
12-16S	25,4	1.00	1 1/16-12	1 5/16-12	52,1	2.05	46,0	1.81
12-20S	31,7	1.25	1 1/16-12	1 5/8-12	57,2	2.25	52,3	2.06
14-16S	25,4	1.00	1 3/16-12	1 5/16-12	52,1	2.05	46,0	1.81
16-8S	12,7	0.50	1 5/16-12	3/4-16	52,1	2.05	38,6	1.52
16-10S	16,0	0.63	1 5/16-12	7/8-14	52,1	2.05	41,7	1.64
16-12S	19,0	0.75	1 5/16-12	1 1/16-12	52,1	2.05	44,7	1.76
16-16S	25,4	1.00	1 5/16-12	1 5/16-12	52,1	2.05	46,0	1.81
16-20S	31,7	1.25	1 5/16-12	1 5/8-12	57,2	2.25	52,3	2.06
20-16S	25,4	1.00	1 5/8-12	1 5/16-12	57,2	2.25	51,1	2.01
20-20S	31,7	1.25	1 5/8-12	1 5/8-12	57,2	2.25	52,3	2.06
20-24S	38,1	1.50	1 5/8-12	1 7/8-12	60,7	2.39	59,2	2.33
24-20S	31,7	1.25	1 7/8-12	1 5/8-12	60,7	2.39	55,9	2.20
24-24S	38,1	1.50	1 7/8-12	1 7/8-12	60,7	2.39	59,2	2.33

Adapters and tube fittings

SAE O-Ring boss to 37° flare

J

SAE O-Ring boss to 37° flare

SAE O-Ring boss (adj.)/37° flare

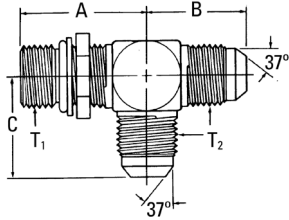

Part no. 203005-(Dash size) (Ref. SAE 070428)

Dash size	Tube O.D.		Thread T1	Thread T2	A		B		C	
	mm	in			mm	in	mm	in	mm	in
4-4S	6,3	0.25	7/16-20	7/16-20	26,2	1.03	22,6	0.89	22,6	0.89
5-5S	7,9	0.31	1/2-20	1/2-20	28,7	1.13	24,1	0.95	24,1	0.95
6-4-4S	6,3	0.25	9/16-18	7/16-20	31,8	1.25	26,7	1.05	26,7	1.05
6-6S	9,6	0.38	9/16-18	9/16-18	31,8	1.25	26,9	1.06	26,9	1.06
8-8S	12,7	0.50	3/4-16	3/4-16	36,8	1.45	31,8	1.25	31,8	1.25
10-10S	16,0	0.63	7/8-14	7/8-14	43,2	1.70	36,8	1.45	36,8	1.45
12-12S	19,0	0.75	1 1/16-12	1 1/16-12	49,3	1.94	42,2	1.66	42,2	1.66
12-16-16S	25,4	1.00	1 1/16-12	1 5/16-12	52,1	2.05	46,0	1.81	46,0	1.81
16-16S	25,4	1.00	1 5/16-12	1 5/16-12	52,1	2.05	46,0	1.81	46,0	1.81
20-20S	31,7	1.25	1 5/8-12	1 5/8-12	57,2	2.25	52,3	2.06	52,3	2.06

SAE O-Ring boss (adj.)/37° flare

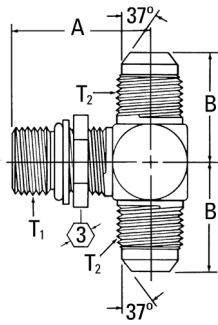

Part no. 203003-(Dash size) (Ref. SAE 070429)

Dash size	Tube O.D.		Thread T1	Thread T2	A		B	
	mm	in			mm	in	mm	in
4-4S	6,3	0.25	7/16-20	7/16-20	26,2	1.03	22,6	0.89
5-5S	7,9	0.31	1/2-20	1/2-20	28,7	1.13	24,1	0.95
6-6S	9,6	0.38	9/16-18	9/16-18	31,8	1.25	26,9	1.06
8-8S	12,7	0.50	3/4-16	3/4-16	36,8	1.45	31,8	1.25
10-12-12S	19,0	0.95	7/8-14	1 1/16-12	45,2	1.78	42,2	1.66
12-12S	19,0	0.75	1 1/16-12	1 1/16-12	49,3	1.94	42,2	1.66
16-12-12S	19,0	0.75	1 5/16-12	1 1/16-12	52,1	2.05	44,7	1.76
12-16-16S	25,4	1.00	1 1/16-12	1 5/16-12	52,1	2.05	46,0	1.81
16-16S	25,4	1.00	1 5/16-12	1 5/16-12	52,1	2.05	46,0	1.81
20-20S	31,7	1.25	1 5/8-12	1 5/8-12	57,2	2.25	52,3	2.06

SAE split flange to ORS

ORS/split flange (Code 62)

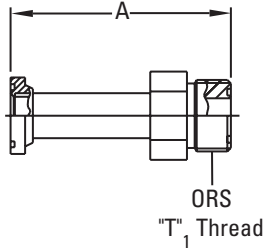

Part no. FF5943T-(Dash size)

Dash size	Tube O.D.		Thread T1	A	
	mm	in		mm	in
1212S	19,0	0.75	1 3/16-12	77,7	3.06
1616S	25,4	1.00	1 7/16-12	90,7	3.57

45° ORS/split flange (Code 61)

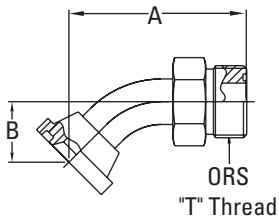

Part no. FF6001T-(Dash size)

Dash size	Tube O.D.		Thread T	A		B	
	mm	in		mm	in	mm	in
1616S	25,4	1.00	1 7/16-12	86,6	3.41	26,9	1.06
2424S	38,1	1.50	2-12	57,2	2.25	35,8	1.41

45° ORS/split flange (Code 62)

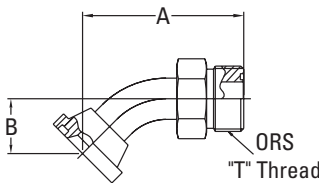

Part no. FF6002T-(Dash size)

Dash size	Tube O.D.		Thread T	A		B	
	mm	in		mm	in	mm	in
1212S	19,0	0.75	1 3/16-12	74,7	2.94	25,4	1.00
1616S	25,4	1.00	1 7/16-12	86,6	3.41	26,9	1.06

Adapters and tube fittings

SAE split flange to ORS

J

SAE split flange to ORS

90° ORS/split flange (Code 61)

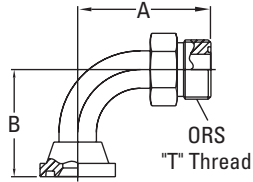

Part no. FF5946T-(Dash size)

Dash size	Tube O.D.		Thread T	A		B	
	mm	in		mm	in	mm	in
1212S	19,0	0.75	1 3/16-12	67,3	2.65	54,1	2.13
1216S	19,0	0.75	1 3/16-12	67,3	2.65	54,1	2.13
1616S	25,4	1.00	1 7/16-12	81,8	3.22	60,2	2.37
2020S	31,7	1.25	1 11/16-12	88,1	3.47	66,5	2.62
2424S	38,1	1.50	2-12	100,8	3.97	79,2	3.12

90° ORS/split flange (Code 62)

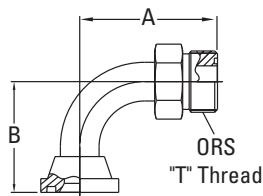

Part no. FF5945T-(Dash size)

Dash size	Tube O.D.		Thread T	A		B	
	mm	in		mm	in	mm	in
1212S	19,0	0.75	1 3/16-12	67,3	2.65	54,1	2.13
1612S	25,4	1.00	1 7/16-12	67,3	2.65	54,1	2.13
1616S	25,4	1.00	1 7/16-12	81,8	3.22	60,2	2.37
1620S	25,4	1.00	1 7/16-12	88,1	3.47	66,5	2.62
2020S	31,7	1.25	1 11/16-12	88,1	3.47	66,5	2.62
2424S	38,1	1.50	2-12	100,8	3.97	79,2	3.12

90° ORS/split flange (Code 62)

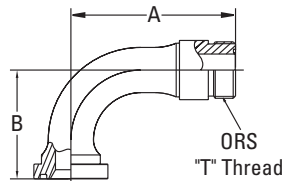

Part no. FF6062T-(Dash size)

Dash size	Tube O.D.		Thread T	A		B	
	mm	in		mm	in	mm	in
1616S	25,4	1.00	1 7/16-12	105,9	4.17	70,1	2.76

90° ORS/split flange (Code 62)

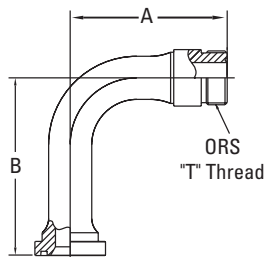

Part no. FF6063T-(Dash size)

Dash size	Tube O.D.		Thread T	A		B	
	mm	in		mm	in	mm	in
1616S	25,4	1.00	1 7/16-12	105,9	4.17	119,9	4.72

90° ORS/split flange (Code 62)

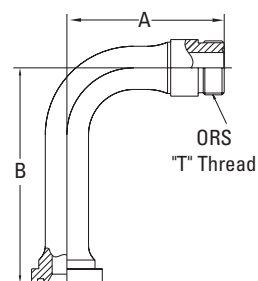

Part no. FF6064T-(Dash size)

Dash size	Tube O.D.		Thread T	A		B	
	mm	in		mm	in	mm	in
1616S	25,4	1.00	1 7/16-12	105,9	4.17	144,8	5.70

SAE split flange to ORS

90° ORS/split flange (Code 62)

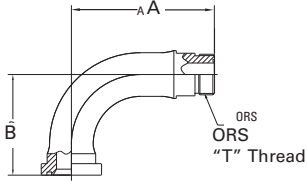

Part no. FF6071T-(Dash size)

Dash size	Tube O.D.		Thread T	A		B	
	mm	in		mm	in	mm	in
1620S	25,4	1.00	1 7/16-12	128,0	5.04	89,9	3.54

90° ORS/split flange (Code 62)

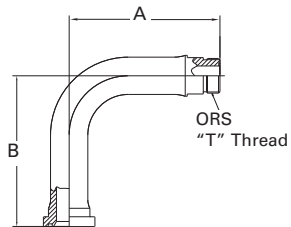

Part no. FF6072T-(Dash size)

Dash size	Tube O.D.		Thread T	A		B	
	mm	in		mm	in	mm	in
1620S	25,4	1.00	1 7/16-12	158,0	6.22	158,0	6.22

100° ORS/split flange (Code 62)

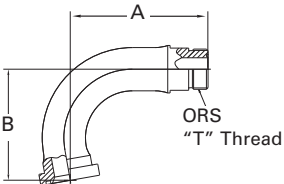

Part no. FF6073T-(Dash size)

Dash size	Tube O.D.		Thread T	A		B	
	mm	in		mm	in	mm	in
1620S	25,4	1.00	1 7/16-12	124,5	4.90	100,3	3.95

ORS/split flange (Code 62)

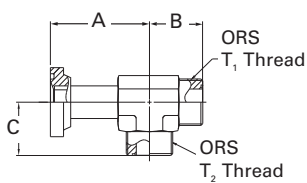

Part no. FF2522T-(Dash size)

Dash size	Tube O.D.		Thread T1	Thread T2	A		B		C	
	mm	in			mm	in	mm	in	mm	in
1616S	25,4	1.00	1 7/16-12	1 7/16-12	78,7	3.10	41,6	1.64	41,6	1.64
1620S	25,4	1.00	1 7/16-12	1 7/16-12	77,5	3.05	41,6	1.64	41,6	1.64

Adapters and tube fittings

SAE split flange to 37° flare

J

SAE split flange to 37° flare

Split flange/37° flare SAE
Standard pressure series (Code 61)

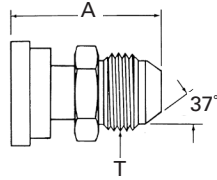

Part no. 500025-(Dash size) (mates with 449-74446 flanges)

The performance rating of these adapters is the lower of the two terminal ends. These adapters are rated to JIC pressures as specified in SAE J514.

Dash size	Split flange size	Tube O.D.		Thread T	A	
		mm	in		mm	in
8S	1/2	12,7	0.50	3/4-16	42,2	1.66
12S	3/4	19,0	0.75	1 1/16-12	48,5	1.91
12-8S	3/4	12,7	0.50	3/4-16	51,6	2.03
16S	1	25,4	1.00	1 5/16-12	51,1	2.01
16-10S	1	16,0	0.63	7/8-14	47,2	1.86
16-12S	1	19,0	0.75	1 1/16-12	58,4	2.30
20S	1 1/4	31,7	1.25	1 5/8-12	62,5	2.46
20-16S	1 1/4	25,4	1.00	1 5/16-12	59,7	2.35
20-24S	1 1/4	38,1	1.50	1 7/8-12	67,0	2.64
24S	1 1/2	38,1	1.50	1 7/8-12	68,8	2.71
24-16S	1 1/2	25,4	1.00	1 5/16-12	61,2	2.41
24-20S	1 1/2	31,7	1.25	1 5/8-12	62,5	2.46
32S	2	50,8	2.00	2 1/2-12	78,2	3.08
32-16S	2	25,4	1.00	1 5/16-12	58,9	2.32
32-20S	2	31,7	1.25	1 5/8-12	64,0	2.52
32-24S	2	38,1	1.50	1 7/8-12	68,8	2.71

Split flange/37° flare SAE
Standard pressure series (Code 61)

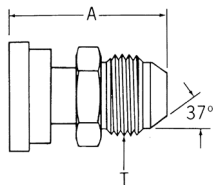

Part no. FF5239-(Dash size) (mates with 449-74446 flanges)

The performance rating of these adapters is the lower of the two terminal ends. These adapters are rated to JIC pressures as specified in SAE J514.

Dash size	Split flange size	Tube O.D.		Thread T	A	
		mm	in		mm	in
1212S	3/4	19,0	0.75	1 1/16-12	80,5	3.17
1616S	1	25,4	1.00	1 5/16-12	95,5	3.76
2020S	1 1/4	31,7	1.25	1 5/8-12	97,5	3.84
2424S	1 1/2	38,1	1.50	1 7/8-12	118,6	4.67
3232S	2	50,8	2.00	2 1/2-12	143,0	5.63

Split flange/37° flare SAE
Standard pressure series (Code 62)

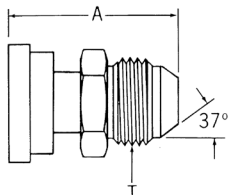

Part no. FF5541-(Dash size) (mates with FC3425- size-449 flanges)

The performance rating of these adapters is the lower of the two terminal ends. These adapters are rated to JIC pressures as specified in SAE J514.

Dash size	Split flange size	Tube O.D.		Thread T	A	
		mm	in		mm	in
1212S	3/4	19,0	0.75	1 1/16-12	80,5	3.17
1616S	1	25,4	1.00	1 5/16-12	95,5	3.76
2016S	1 1/4	25,4	1.00	1 5/16-12	95,5	3.76
2020S	1 1/4	31,7	1.25	1 5/8-12	97,5	3.84
2416S	1 1/2	25,4	1.00	1 5/16-12	95,5	3.76
2420S	1 1/2	31,7	1.25	1 5/8-12	97,5	3.84
2424S	1 1/2	38,1	1.50	1 7/8-12	118,6	4.67

SAE split flange to 37° flare

Split flange/37° flare SAE Standard pressure series (Code 62)

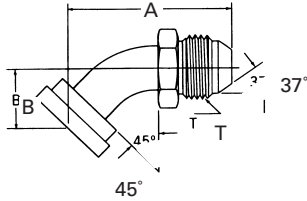

Part no. FF5539-(Dash size) (mates with FC3425-size-449 flanges)

The performance rating of these adapters is the lower of the two terminal ends. These adapters are rated to JIC pressures as specified in SAE J514.

Dash size	Split flange size	Tube O.D.		Thread T	A		B	
		mm	in		mm	in	mm	in
1612S	1	19,0	0.75	1 1/16-12	78,5	3.09	25,4	1.00
1616S	1	25,4	1.00	1 1/16-12	91,4	3.60	26,9	1.06
2020S	1 1/4	31,7	1.25	1 5/8-12	98,0	3.86	29,2	1.15
2416S	1 1/2	25,4	1.00	1 5/16-12	103,1	4.06	31,8	1.25
2420S	1 1/2	31,7	1.25	1 5/8-12	98,0	3.86	29,2	1.15
2424S	1 1/2	38,1	1.50	1 7/8-12	117,1	4.61	35,8	1.41

Split flange/37° flare SAE Standard pressure series (Code 61)

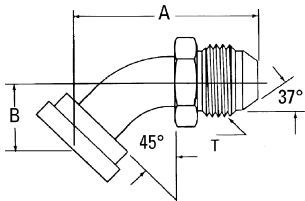

Part no. 500023-(Dash size) (mates with 449-74446 flanges)

The performance rating of these adapters is the lower of the two terminal ends. These adapters are rated to JIC pressures as specified in SAE J514.

Dash size	Split flange size	Tube O.D.		Thread T	A		B	
		mm	in		mm	in	mm	in
8S	1/2	12,7	0.50	3/4-16	59,4	2.34	25,4	1.00
12S	3/4	19,0	0.75	1 1/16-12	70,3	2.77	25,7	1.01
12-8S	3/4	12,7	0.50	3/4-16	59,4	2.34	25,4	1.00
16S	1	25,4	1.00	1 5/16-12	77,2	3.04	28,7	1.13
16-10S	1	16,0	0.63	7/8-14	65,5	2.58	25,4	1.00
16-12S	1	19,0	0.75	1 1/16-12	70,3	2.77	25,7	1.01
20S	1 1/4	31,7	1.25	1 5/8-12	82,3	3.24	28,5	1.12
20-12S	1 1/4	19,0	0.75	1 1/16-12	70,3	2.77	25,7	1.01
20-16S	1 1/4	25,4	1.00	1 5/16-12	77,2	3.04	28,7	1.13
24S	1 1/2	38,1	1.50	1 7/8-12	89,9	3.54	28,5	1.12
24-16S	1 1/2	25,4	1.00	1 5/16-12	78,2	3.08	29,7	1.17
24-20S	1 1/2	31,7	1.25	1 5/8-12	82,3	3.24	28,5	1.12
24-32S	1 1/2	50,8	2.00	2 1/2-12	99,3	3.91	28,5	1.12
32S	2	50,8	2.00	2 1/2-12	107,7	4.24	31,8	1.25
40S	2 1/2	63,5	2.50	3-12	131,6	5.18	42,2	1.66
40-24S	2 1/2	38,1	1.50	1 7/8-12	90,9	3.58	29,7	1.17

Split flange/37° flare SAE Standard pressure series (Code 61)

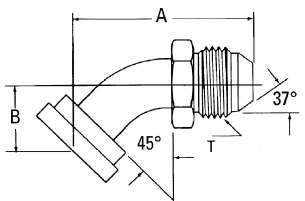

Part no. FF5238-(Dash size) (mates with 449-74446 flanges)

The performance rating of these adapters is the lower of the two terminal ends. These adapters are rated to JIC pressures as specified in SAE J514.

Dash size	Split Flange Size	Tube O.D.		Thread T	A		B	
		mm	in		mm	in	mm	in
1212S	3/4	19,0	0.75	1 1/16-12	78,5	3.09	25,4	1.00
1616S	1	25,4	1.00	1 5/16-12	91,4	3.60	26,9	1.06
2020S	1 1/4	31,7	1.25	1 5/8-12	98,0	3.86	29,2	1.15
2420S	1 1/2	31,7	1.25	1 5/8-12	98,0	3.86	35,8	1.41
2424S	1 1/2	38,1	1.50	1 7/8-12	117,1	4.61	35,8	1.41
3232S	2	50,8	2.00	2 1/2-12	153,4	6.04	50,8	2.00

Adapters and tube fittings

SAE split flange to 37° flare

J

SAE split flange to 37° flare

Split flange/37° flare SAE
Standard pressure series (Code 61)

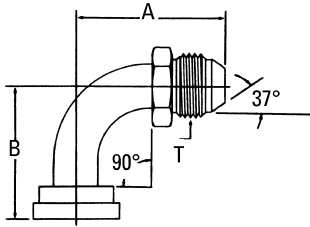

Part no. 500024-(Dash size) (mates with 449-74446 flanges)

The performance rating of these adapters is the lower of the two terminal ends. These adapters are rated to JIC pressures as specified in SAE J514.

Dash size	Split flange Size	Tube O.D.		Thread T	A		B	
		mm	in		mm	in	mm	in
8S	1/2	12,7	0.50	3/4-16	45,2	1.78	41,1	1.62
12S	3/4	19,0	0.75	1 1/16-12	63,2	2.49	54,6	2.15
12-8S	3/4	12,7	0.50	3/4-16	45,2	1.78	41,1	1.62
12-10S	3/4	16,0	0.63	7/8-14	60,4	2.38	54,6	2.15
16S	1	25,4	1.00	1 5/16-12	70,9	2.79	60,2	2.37
16-10S	1	16,0	0.63	7/8-14	54,9	2.16	53,9	2.12
16-12S	1	19,0	0.75	1 1/16-12	63,2	2.49	54,6	2.15
20S	1 1/4	31,7	1.25	1 5/8-12	79,7	3.14	63,5	2.50
20-12S	1 1/4	19,0	0.75	1 1/16-12	63,2	2.49	54,6	2.15
20-16S	1 1/4	25,4	1.00	1 5/16-12	70,9	2.79	60,2	2.37
20-24S	1 1/4	38,1	1.50	1 7/8-12	90,9	3.58	68,3	2.69
24S	1 1/2	38,1	1.50	1 7/8-12	90,9	3.58	69,8	2.75
24-16S	1 1/2	25,4	1.00	1 5/16-12	70,9	2.79	62,0	2.44
24-20S	1 1/2	31,7	1.25	1 5/8-12	79,7	3.14	63,5	2.50
24-32S	1 1/2	50,8	2.00	1 7/8-12	100,4	3.95	69,8	2.75
32S	2	50,8	2.00	2 1/2-12	113,3	4.46	82,5	3.25
32-20S	2	31,7	1.25	1 5/8-12	79,7	3.14	65,0	2.56
32-24S	2	38,1	1.50	1 7/8-12	90,9	3.58	69,8	2.75
40-20S	2 1/2	31,7	1.25	1 5/8-12	87,9	3.46	71,4	2.81
40-24S	2 1/2	38,1	1.50	1 7/8-12	90,9	3.58	71,4	2.81
40-30S	2 1/2	50,8	2.00	2 1/2-12	113,3	4.46	84,1	3.31
40-40S	2 1/2	63,5	2.50	3-12	148,8	5.86	131,8	5.19

Split flange/37° flare SAE
Standard pressure series (Code 61)

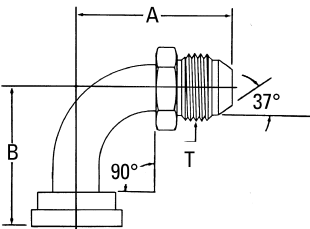

Part no. FF5162-(Dash size) (mates with 449-74446 flanges)

The performance rating of these adapters is the lower of the two terminal ends. These adapters are rated to JIC pressures as specified in SAE J514.

Dash size	Split flange Size	Tube O.D.		Thread T	A		B	
		mm	in		mm	in	mm	in
0808S	1/2	12,7	0.50	3/4-16	54,9	2.16	41,1	1.62
1212S	3/4	19,0	0.75	1 1/16-12	71,4	2.81	54,1	2.13
1612S	1	19,0	0.75	1 1/16-12	71,4	2.81	54,1	2.13
1616S	1	25,4	1.00	1 5/16-12	86,6	3.41	60,4	2.38
1620S	1	31,7	1.25	1 5/8-12	87,9	3.46	60,4	2.38
2016S	1 1/4	25,4	1.00	1 5/16-12	86,6	3.41	60,4	2.38
2020S	1 1/4	31,7	1.25	1 5/8-12	94,2	3.71	66,5	2.62
2416S	1 1/2	25,4	1.00	1 5/16-12	86,6	3.41	60,4	2.38
2420S	1 1/2	31,7	1.25	1 5/8-12	94,2	3.71	66,5	2.62
2424S	1 1/2	38,1	1.50	1 7/8-12	110,0	4.33	79,2	3.12
3232S	2	50,8	2.00	2 1/2-12	145,0	5.71	114,3	4.50

SAE split flange to 37° flare

Split flange/37° flare SAE High pressure series (Code 62)

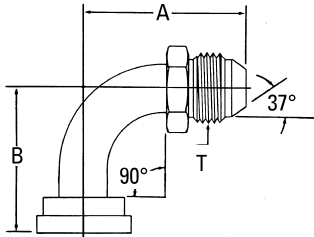

Part no. FF5540-(Dash size) (mates with FC3425 - size-449 flanges)

The performance rating of these adapters is the lower of the two terminal ends. These adapters are rated to JIC pressures as specified in SAE J514.

Dash size	Split flange size	Tube O.D.		Thread T	A		B	
		mm	in		mm	in	mm	in
1212S	3/4	19,0	0.75	1 1/16-12	71,4	2.81	54,1	2.13
1612S	1	19,0	0.75	1 1/16-12	71,4	2.81	54,1	2.13
1616S	1	25,4	1.00	1 5/16-12	86,6	3.41	60,4	2.38
2016S	1 1/4	25,4	1.00	1 5/16-12	86,6	3.41	60,4	2.38
2020S	1 1/4	31,7	1.25	1 5/8-12	94,2	3.71	66,5	2.62
2416S	1 1/2	25,4	1.00	1 5/16-12	86,6	3.41	69,8	2.75
2420S	1 1/2	31,7	1.25	1 5/8-12	94,2	3.71	66,5	2.62
2424S	1 1/2	38,1	1.50	1 7/8-12	110,0	4.33	79,2	3.12

SAE swivel flange to SAE split flange

SAE swivel flange/split flange SAE Standard pressure series (Code 61)

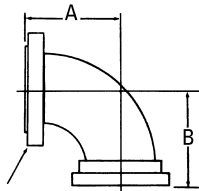

Part no. 504089-(Dash size)

(suitable for pressures through SAE 100R16 2 wire braid hose)

Dash size	Shoulder size	Flange size	A		B	
			mm	in	mm	in
16S	1	1	52,3	2.06	60,2	2.37
20S	1 1/4	1 1/4	58,7	2.31	63,5	2.50
24S	1 1/2	1 1/2	66,5	2.62	69,8	2.75
32S	2	2	79,2	3.12	82,5	3.25
40S	2 1/2	2 1/2	119,1	4.69	131,8	5.19

SAE swivel flange/split flange SAE Standard pressure series (Code 61)

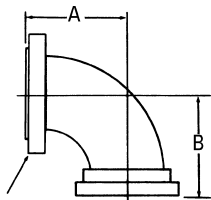

Part no. FF5321-(Dash size)

(suitable for pressures through SAE 100R12 4 spiral hose)

Dash size	Shoulder size	Flange size	A		B	
			mm	in	mm	in
1616S	1	1	60,4	2.38	60,4	2.38
2020S	1 1/4	1 1/4	66,5	2.62	66,5	2.62
2424S	1 1/2	1 1/2	79,2	3.12	79,2	3.12
3232S	2	2	114,3	4.50	114,3	4.50

Adapters and tube fittings

SAE flareless to 37° union

J

SAE flareless to 37° union

Male SAE flareless/37° flare*

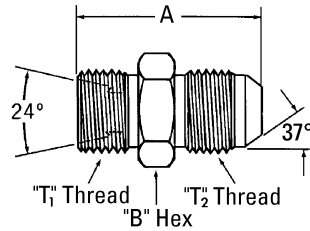

Part no. FF1315-(Dash size)

Dash size	Tube O.D.		Thread T1	Thread T2	A		B	
	mm	in			mm	in	mm	in
0404S	6,3	0.25	7/16-20	7/16-20	31,0	1.22	12,7	0.50
0604S	9,6	0.38	9/16-18	7/16-20	32,3	1.27	15,7	0.62
0606S	9,6	0.38	9/16-18	9/16-18	32,5	1.28	15,7	0.62
0806S	12,7	0.50	3/4-16	9/16-18	34,8	1.37	20,6	0.81
0808S	12,7	0.50	3/4-16	3/4-16	37,3	1.47	20,6	0.81
1008S	16,0	0.63	7/8-14	3/4-16	40,4	1.59	23,9	0.94
1010S	16,0	0.63	7/8-14	7/8-14	42,9	1.69	23,9	0.94
1212S	19,0	0.75	1 1/16-12	1 1/16-12	49,0	1.93	28,5	1.12
1616S	25,4	1.00	1 5/16-12	1 5/16-12	50,3	1.98	35,1	1.38

Flareless tube nut*

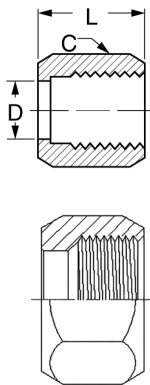

Part no. 210294-(Dash size)

Use with FF1315-(Dash size) body only
(Ref. SAE 080110)

Dash size	Tube O.D.		Thread T	A		B	
	mm	in		mm	in	mm	in
4S	6,3	0.25	7/16-20	17,8	0.70	14,2	0.56
6S	9,6	0.38	9/16-18	19,0	0.75	17,6	0.69
8S	12,7	0.50	3/4-16	21,3	0.84	22,4	0.88
10S	16,0	0.63	7/8-14	23,4	0.92	25,4	1.00
12S	19,0	0.75	1 1/16-12	24,6	0.97	31,8	1.25
14S	22,3	0.88	1 3/16-12	25,4	1.00	35,1	1.38
16S	25,4	1.00	1 5/16-12	26,7	1.05	38,1	1.50

Ferrule-style A* (for flareless tube fittings)

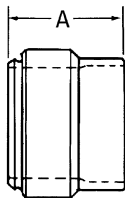

Part no. FF9173-(Dash size)

Use with FF1315-(Dash size) body only
(Ref. SAE 080115A)

Dash size	Tube O.D.		A	
	mm	in	mm	in
04S	6,3	0.25	9,1	0.36
06S	9,6	0.38	9,9	0.39
08S	12,7	0.50	10,9	0.43
10S	16,0	0.63	11,2	0.44
12S	19,0	0.75	11,9	0.47
16S	25,4	1.00	12,2	0.48

Note: *All three components (adapter FF1315, tube nut 210294 and ferrule FF9173) required for assembly. Order by Part Number FF1316-(Dash size) for complete assembly.

Brace and weld to split flange

Brace/solid flanged head SAE
Standard pressure series (Code 61)

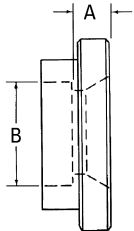

Part no. 71418-(Dash size)

Dash size	Split flange size	Tube O.D.		A		B	
		mm	in	mm	in	mm	in
12-12S	3/4	19,0	0.75	7,9	0.31	19,0	0.75
16-12S	3/4	25,4	1.00	7,9	0.31	25,4	1.00
16-16S	1	25,4	1.00	7,9	0.31	25,4	1.00
20-20S	1 1/4	31,7	1.25	7,9	0.31	31,8	1.25
24-24S	1 1/2	38,1	1.50	9,7	0.38	38,1	1.50
32-32S	2	50,8	2.00	9,7	0.38	50,8	2.00
40-40S	2 1/2	63,5	2.50	11,2	0.44	63,5	2.50

Brace/(flanged head) SAE
Standard pressures series (Code 61)

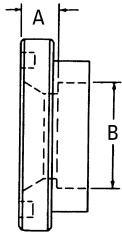

Part no. 4624-(Dash size)

Dash size	Split flange size	Tube O.D.		A		B	
		mm	in	mm	in	mm	in
8S	1/2	12,7	0.50	6,4	0.25	12,7	0.50
12S	3/4	19,0	0.75	7,9	0.31	19,0	0.75
12-8S	3/4	12,7	0.50	6,4	0.25	12,7	0.50
12-10S	3/4	16,0	0.63	7,9	0.31	15,7	0.62
12-16S	3/4	25,4	1.00	7,9	0.31	25,4	1.00
16S	1	25,4	1.00	7,9	0.31	25,4	1.00
16-10S	1	16,0	0.63	10,4	0.41	15,7	0.62
16-12S	1	19,0	0.75	7,9	0.31	19,0	0.75
16-20S	1	31,7	1.25	7,9	0.31	31,8	1.25
20S	1 1/4	31,7	1.25	7,9	0.31	31,8	1.25
20-12S	1 1/4	19,0	0.75	7,9	0.31	19,0	0.75
20-16S	1 1/4	25,4	1.00	7,9	0.31	25,4	1.00
20-24S	1 1/4	38,1	1.50	7,9	0.31	38,1	1.50
24S	1 1/2	38,1	1.50	9,7	0.38	38,1	1.50
24-12S	1 1/2	19,0	0.75	9,7	0.38	19,0	0.75
24-16S	1 1/2	25,4	1.00	9,7	0.38	25,4	1.00
24-20S	1 1/2	31,7	1.25	7,9	0.31	31,8	1.25
32S	2	50,8	2.00	9,7	0.38	50,8	2.00
32-16S	2	25,4	1.00	7,1	0.28	25,4	1.00
32-20S	2	31,7	1.25	9,7	0.38	31,8	1.25
32-24S	2	38,1	1.50	9,7	0.38	38,1	1.50
40-32S	2 1/2	50,8	2.00	11,2	0.44	50,8	2.00

Adapters and tube fittings

Braze and weld to split flange

J

Braze and weld to split flange

Buttweld (pipe)/solid flanged head SAE
Standard pressure series (Code 61)

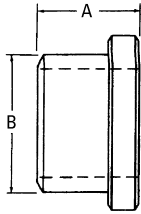

Part no. 71416-(Dash size)

Dash size	Flange Size	A		B	
		mm	in	mm	in
16S	1	27,4	1.08	33,6	1.32
20S	1 1/4	27,4	1.08	42,2	1.66
24S	1 1/2	29,0	1.14	48,3	1.90
32S	2	29,0	1.14	60,4	2.38

Saddle weld (pipe)/solid flanged head SAE
Standard pressure series (Code 61)

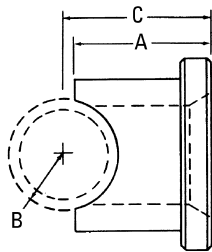

Part no. 71422-(Dash size)

Dash size	Flange Size	A		B		C	
		mm	in	mm	in	mm	in
20-20S	1 1/4	32,3	1.27	21,0	0.83	44,9	1.77

Braze/(flanged head) SAE
High pressure series (Code 62)

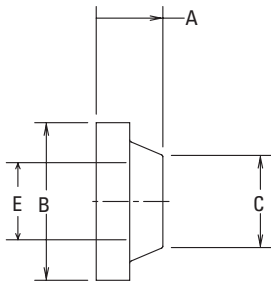

Part no. FC1102-(Dash size)

Dash size	Tube O.D.		A		B		C		E	
	mm	in	mm	in	mm	in	mm	in	mm	in
0808S	12,7	0.50	15,7	0.62	31,7	1.25	17,8	0.70	9,9	0.39
1208S	12,7	0.50	15,7	0.62	41,4	1.63	24,1	0.95	9,9	0.39
1212S	19,0	0.75	17,5	0.69	41,4	1.63	24,1	0.95	14,7	0.58
1612S	25,4	1.00	17,5	0.69	47,7	1.88	31,5	1.24	14,7	0.58
1616S	25,4	1.00	15,7	0.62	47,7	1.88	31,5	1.24	20,8	0.82
2012S	31,7	1.25	15,7	0.62	54,1	2.13	38,3	1.51	19,0	0.75
2016S	31,7	1.25	15,7	0.62	54,1	2.13	38,3	1.51	20,8	0.82
2020S	31,7	1.25	15,7	0.62	54,1	2.13	38,1	1.50	26,7	1.05
2416S	38,1	1.50	15,7	0.62	63,5	2.50	46,5	1.83	20,8	0.82
2420S	38,1	1.50	15,7	0.62	63,5	2.50	46,5	1.83	26,7	1.05
2424S	38,1	1.50	19,0	0.75	63,5	2.50	46,5	1.83	32,2	1.27
3224S	50,8	2.00	19,0	0.75	79,5	3.13	63,0	2.48	32,2	1.27
3232S	50,8	2.00	28,4	1.12	79,5	3.13	58,7	2.31	43,7	1.72

Braze/solid flanged head SAE
High pressure series (Code 62)

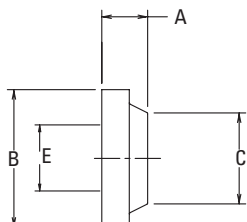

Part no. FC1132-(Dash size)

Dash size	Tube O.D.		A		B		C		E	
	mm	in	mm	in	mm	in	mm	in	mm	in
1616	25,4	1.00	15,7	0.62	47,7	1.88	31,5	1.24	20,5	0.81

Braze and weld to 37° flare

Weld port/37° flare

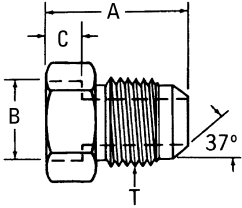

Part no. 202232-(Dash size)

Dash size	IPS Size		Thread T	A		B		C	
	mm	in		mm	in	mm	in	mm	in
1/4-8S	6,3	0.25	3/4-16	30,5	1.20	14,2	0.56	9,7	0.38
1/2-12S	12,7	0.50	1 1/16-12	39,1	1.54	21,8	0.86	12,7	0.50
1-20S	25,4	1.00	1 5/8-12	46,0	1.81	34,0	1.34	16,0	0.63

Braze port/37° flare

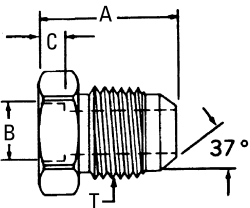

Part no. 73014-(Dash size)

Dash size	Tube O.D.		Thread T	A		B		C	
	mm	in		mm	in	mm	in	mm	in
4S	6,3	0.25	7/16-20	18,8	0.74	6,4	0.25	4,0	0.16
5S	7,9	0.31	1/2-20	20,3	0.80	7,9	0.31	4,0	0.16
6S	9,6	0.38	9/16-18	20,6	0.81	9,7	0.38	4,0	0.16
8S	12,7	0.50	3/4-16	23,9	0.94	12,7	0.50	4,0	0.16
8-6S	12,7	0.50	9/16-18	21,3	0.84	12,7	0.50	4,0	0.16
10S	16,0	0.63	7/8-14	27,2	1.07	15,7	0.62	4,0	0.16
12S	19,0	0.75	1 1/16-12	31,5	1.24	19,0	0.75	6,4	0.25
12-10S	19,0	0.75	7/8-14	28,7	1.13	19,0	0.75	6,4	0.25
14S	22,3	0.88	1 3/16-12	32,0	1.26	22,4	0.88	6,4	0.25
16S	25,4	1.00	1 5/16-12	32,8	1.29	25,4	1.00	6,4	0.25
16-12S	25,4	1.00	1 1/16-12	31,5	1.24	25,4	1.00	6,4	0.25
20S	31,7	1.25	1 5/8-12	35,6	1.40	31,8	1.25	6,4	0.25
20-16S	31,7	1.25	1 5/16-12	32,8	1.29	31,8	1.25	6,4	0.25
24S	38,1	1.50	1 7/8-12	40,1	1.58	38,1	1.50	6,4	0.25
24-16S	38,1	1.50	1 5/16-12	35,8	1.41	38,1	1.50	6,4	0.25
24-20S	38,1	1.50	1 5/8-12	37,1	1.46	38,1	1.50	6,4	0.25
24-32S	38,1	1.50	2 1/2-12	49,5	1.95	38,1	1.50	6,4	0.25
32S	50,8	2.00	2 1/2-12	49,8	1.96	50,8	2.00	6,4	0.25
40S	63,5	2.50	3-12	47,2	1.86	63,5	2.50	6,4	0.25

Adapters and tube fittings

Versil-Flare - flareless and flared

J

Versil-Flare - flareless and flared

Versil-Flare flareless tube nut

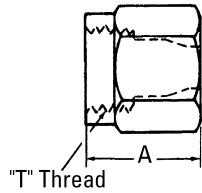

Part no. FC2875-(Dash size)

Use with FF9605-(Dash size) ferrule only

Dash size	Tube O.D.		Thread T	A	
	mm	in		mm	in
03S	4,8	0.19	3/8-24	20,1	0.79
04S	6,3	0.25	7/16-20	20,8	0.82
05S	7,9	0.31	1/2-20	20,8	0.82
06S	9,6	0.38	9/16-18	21,8	0.86
08S	12,7	0.50	3/4-16	27,4	1.08
10S	16,0	0.63	7/8-14	28,5	1.12
12S	19,0	0.75	1 1/16-12	34,5	1.36
16S	25,4	1.00	1 5/16-12	35,6	1.40
20S	31,7	1.25	1 5/8-12	45,7	1.80
24S	38,1	1.50	1 7/8-12	46,7	1.84
32S	50,8	2.00	2 1/2-12	55,9	2.20

Versil-Flare flareless tube ferrule

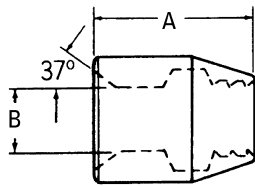

Part no. FF9605-(Dash size)

Use with FC2875-(Dash size) nut only

Dash size	Tube O.D.		A		B	
	mm	in	mm	in	mm	in
03S	4,8	0.19	10,2	0.40	4,8	0.19
04S	6,3	0.25	10,7	0.42	6,4	0.25
05S	7,9	0.31	10,7	0.42	7,9	0.31
06S	9,6	0.38	11,7	0.46	9,7	0.38
08S	12,7	0.50	14,5	0.57	12,7	0.50
10S	16,0	0.63	14,7	0.58	15,7	0.62
12S	19,0	0.75	17,8	0.70	19,0	0.75
16S	25,4	1.00	17,8	0.70	25,4	1.00
20S	31,7	1.25	25,4	1.00	31,8	1.25
24S	38,1	1.50	25,4	1.00	38,1	1.50
32S	50,8	2.00	29,7	1.17	50,8	2.00

Versil-Flare - flareless and flared

Versil-Flare SAE 37° flared style "B" nut

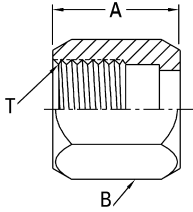

Part no. 1290-(Dash size) (Ref. SAE 070110)

Use with 900605 tube sleeve only

Dash size	Tube O.D.		Thread T	A		B	
	mm	in		mm	in	mm	in
3S	4,8	0.19	3/8-24	15,2	0.60	11,2	0.44
4S	6,3	0.25	7/16-20	15,7	0.62	14,2	0.56
5S	7,9	0.31	1/2-20	17,0	0.67	15,7	0.62
6S	9,6	0.38	9/16-18	18,3	0.72	17,6	0.69
8S	12,7	0.50	3/4-16	21,3	0.84	22,4	0.88
10S	16,0	0.63	7/8-14	24,6	0.97	25,4	1.00
12S	19,0	0.75	1 1/16-12	25,9	1.02	31,8	1.25
14S	22,3	0.88	1 3/16-12	27,4	1.08	35,1	1.38
16S	25,4	1.00	1 5/16-12	28,5	1.12	38,1	1.50
20S	31,7	1.25	1 5/8-12	31,0	1.22	50,8	2.00
24S	38,1	1.50	1 7/8-12	35,8	1.41	57,2	2.25
32S	50,8	2.00	2 1/2-12	40,4	1.59	73,1	2.88

Note: Also available in stainless steel as Part no. 259-1290.

Versil-Flare SAE 37° flared sleeve

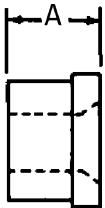

Part no. 900605-(Dash size) (Ref. SAE 070115)

Use with 1290 short nut only

Dash size	Tube O.D.		A	
	mm	in	mm	in
3S	4,8	0.19	8,6	0.34
4S	6,3	0.25	10,4	0.41
5S	7,9	0.31	11,2	0.44
6S	9,6	0.38	12,7	0.50
8S	12,7	0.50	14,2	0.56
10S	16,0	0.63	16,8	0.66
12S	19,0	0.75	17,6	0.69
14S	22,3	0.88	19,3	0.76
16S	25,4	1.00	19,8	0.78
20S	31,7	1.25	23,1	0.91
24S	38,1	1.50	28,5	1.12
32S	50,8	2.00	30,3	1.19

Note: *Also available in stainless steel as Part no. 259-900605.

Adapters and tube fittings

Specials

J

Specials

External pipe/30° flare

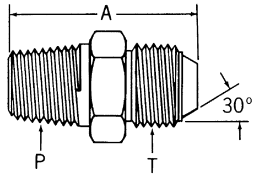

Part no. 2004-(Dash size)

Dash size	Tube O.D.		Thread P	Thread T	A	
	mm	in			mm	in
12-16S	25,4	1.00	3/4-14	1 5/16-14	46,7	1.84
16-16S	25,4	1.00	1-11 1/2	1 5/16-14	51,6	2.03
20-20S	31,7	1.25	1 1/4-11 1/2	1 5/8-14	59,4	2.34

42° Inverted flare/37° flare

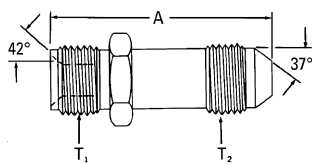

Part no. 202124-(Dash size)

Part no. FF1327-(Dash size) Long*

Dash size	Tube O.D.		Thread T1	Thread T2	A	
	mm	in			mm	in
3-3S	4,8	0.19	3/8-24	3/8-24	27,2	1.07
3-4S	6,3	0.25	3/8-24	7/16-20	29,0	1.14
0304S*	6,3	0.25	3/8-24	7/16-20	61,0	2.40
4-4S	6,3	0.25	7/16-24	7/16-20	29,0	1.14
0404S*	6,3	0.25	7/16-24	7/16-20	61,0	2.40
5-4S	6,3	0.25	1/2-20	7/16-20	29,5	1.16

*Length required to insert adapter at installation.

42° Inverted flare/37° flare

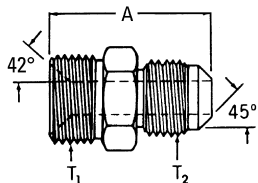

Part no. 200001-(Dash size)

Dash size	Tube O.D.		Thread T1	Thread T2	A	
	mm	in			mm	in
4-4B	6,3	0.25	7/16-24	7/16-20	27,7	1.09
4-5B	7,9	0.31	7/16-24	1/2-20	28,5	1.12
4-6B	9,6	0.38	7/16-24	5/8-18	30,7	1.21
5-4B	6,3	0.25	1/2-20	7/16-20	27,9	1.10
5-5B	7,9	0.31	1/2-20	1/2-20	29,5	1.16
5-6B	9,6	0.38	1/2-20	5/8-18	31,8	1.25
6-5B	7,9	0.31	5/8-18	1/2-20	31,0	1.22
6-6B	9,6	0.38	5/8-18	5/8-18	32,5	1.28
7-6B	9,6	0.38	1 1/16-18	5/8-18	36,3	1.43
7-8B	12,7	0.50	1 1/16-18	3/4-16	39,6	1.56
8-6B	9,6	0.38	3/4-18	5/8-18	36,3	1.43
8-8B	12,7	0.50	3/4-18	3/4-16	39,6	1.56
10-10B	16,0	0.63	7/8-18	7/8-14	44,7	1.76
12-12B	19,0	0.75	1 1/16-16	1 1/16-14	52,0	2.05

30° Inverted flare/37° flare

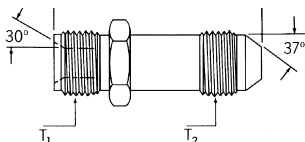

Part no. FF1353-(Dash size)

Part no. FF1354-(Dash size) long*

Dash size	Tube O.D.		Thread T1	Thread T2	A	
	mm	in			mm	in
0404S	6,3	0.25	7/16-20	7/16-20	33,8	1.33
0404St	6,3	0.25	7/16-20	7/16-20	63,5	2.50

*Length required to insert adapter at installation.

Specials

Restrictor male pipe/female pipe

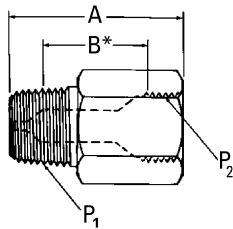

Part no. FF1980-(Dash size)†

Dash size	Tube O.D.		Thread P1	Thread P2	A		B*	
	mm	in			mm	in	mm	in
0404	6,3	0.25	1/4-18	1/4-18	35,3	1.39	16,2	0.64
0606	9,6	0.38	3/8-18	3/8-18	36,6	1.44	17,6	0.69
0808	12,7	0.50	1/2-14	1/2-14	47,5	1.87	22,1	0.87

*Length required to insert adapter at installation.

†Ordering Information: Eaton Restrictor Adapters are available in orifice sizes from 0.60 to 0.25 inches. When ordering restrictor adapters, it is important to indicate the drill size required. For example: For a 0.125 drill size in FF1980-0404 adapter, order as FF1980-125-0404. If you indicate the desired orifice size in inches, the appropriate 3 digit number will be assigned.

Restrictor 37° male flare/37° female

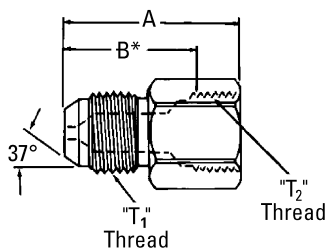

Part no. FF1981-(Dash size)†

Dash size	Tube O.D.		Thread T1	Thread T2	A		B*	
	mm	in			mm	in	mm	in
0404	6,3	0.25	7/16-20	7/16-20	28,9	1.14	17,5	0.69
0606	9,6	0.38	9/16-18	9/16-18	30,2	1.19	18,3	0.72
0808	12,7	0.50	3/4-16	3/4-16	34,5	1.36	25,6	1.01

*Length required to insert adapter at installation.

†Ordering Information: Eaton Restrictor Adapters are available in orifice sizes from 0.60 to 0.25 inches. When ordering restrictor adapters, it is important to indicate the drill size required. For example: For a 0.125 drill size in FF1980-0404 adapter, order as FF1980-125-0404. If you indicate the desired orifice size in inches, the appropriate 3 digit number will be assigned.

Metric to 37° flare

Metric 24° (DIN 3901/3902 I.Rh)/37° flare

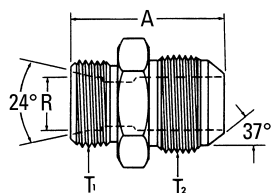

Part no. 15.063-(Dash size)

Dash size	Tube O.D.		Thread T1	Thread T2	A		Rø	
	mm	in			mm	in	mm	in
6-4	6,4	0.25	M12 x 1.5	7/16-20	31,0	1.22	6,0	0.24
8-6	9,7	0.38	M14 x 1.5	9/16-18	31,0	1.22	8,0	0.31
10-8	12,7	0.50	M16 x 1.5	3/4-16	34,5	1.36	10,0	0.39
12-8	12,7	0.50	M18 x 1.5	3/4-16	34,5	1.36	12,0	0.47
15-10	16,0	0.63	M22 x 1.5	7/8-14	39,1	1.54	15,0	0.59
18-12	19,0	0.75	M26 x 1.5	1 1/16-12	42,9	1.69	18,0	0.71
22-16	25,4	1.00	M30 x 2.0	1 5/16-12	46,0	1.81	22,0	0.87

Metric 24° (DIN 3901/3902 s.Rh)/37° flare

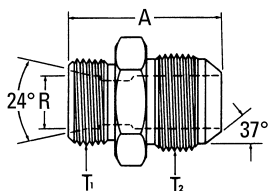

Part no. 15.147-(Dash size)

Dash size	Tube O.D.		Thread T1	Thread T2	A		Rø	
	mm	in			mm	in	mm	in
6-6	9,7	0.38	M14 x 1.5	9/16-18	33,0	1.30	6,0	0.24
10-8	12,7	0.50	M18 x 1.5	3/4-16	35,6	1.40	10,0	0.39
14-10	16,0	0.63	M22 x 1.5	7/8-14	40,4	1.59	14,0	0.55
16-12	19,0	0.75	M24 x 1.5	1 1/16-12	44,9	1.77	16,0	0.63
20-16	25,4	1.00	M30 x 2.0	1 5/16-12	48,0	1.89	20,0	0.79

Adapters and tube fittings

Metric to 37° flare

J

Metric to 37° flare

Metric 60° (DIN 7631)/37° flare

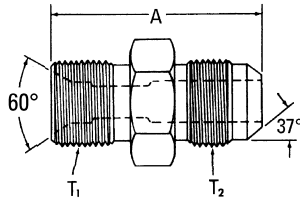

Part no. 15.117-(Dash size)

Dash size	Tube O.D.		Thread T1	Thread T2	A	
	mm	in			mm	in
6-6	9,7	0.38	M14 x 1.5	9/16-18	31,0	1.22
8-6	9,7	0.38	M16 x 1.5	9/16-18	32,0	1.26
8-8	12,7	0.50	M16 x 1.5	3/4-16	34,5	1.36
10-8	12,7	0.50	M18 x 1.5	3/4-16	34,5	1.36
16-12	19,0	0.75	M26 x 1.5	1 1/16-12	42,9	1.69
25-20	31,8	1.25	M38 x 1.5	1 5/8-12	47,5	1.87

Metric 24° (DIN 3901/3902 s.Rh)/37° flare

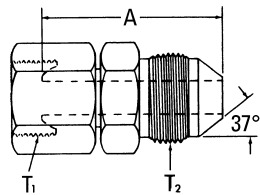

Part no. 15.164-(Dash size)

Dash size	Tube O.D.		Thread T1	Thread T2	A	
	mm	in			mm	in
6-6	9,7	0.38	M14 x 1.5	9/16-18	35,1	1.38
10-8	12,7	0.50	M18 x 1.5	3/4-16	38,1	1.50
14-10	16,0	0.63	M22 x 1.5	7/8-14	40,9	1.61
16-12	19,0	0.75	M24 x 1.5	1 1/16-12	43,4	1.71
20-16	25,4	1.00	M30 x 2.0	1 1/16-12	47,0	1.85
30-24	38,1	1.50	M42 x 2.0	1 7/8-12	53,9	2.12

Metric 24° (DIN 3901/3902 l.Rh)/37° flare

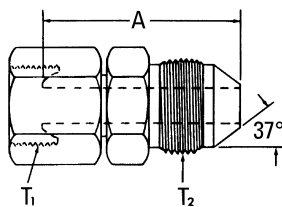

Part no. 15.163-(Dash size)

Dash size	Tube O.D.		Thread T1	Thread T2	A	
	mm	in			mm	in
4-4 †	6,4	0.25	M12 x 1.5	7/16-20	34,5	1.36
6-6 †	9,7	0.38	M14 x 1.5	9/16-18	34,5	1.36
8-6 †	9,7	0.38	M16 x 1.5	9/16-18	35,6	1.40
8-8 †	12,7	0.50	M16 x 1.5	3/4-16	38,1	1.50
10-8 †	12,7	0.50	M18 x 1.5	3/4-16	38,1	1.50
13-10 †	16,0	0.63	M22 x 1.5	7/8-14	40,9	1.61
16-12 †	19,0	0.75	M26 x 1.5	1 1/16-12	47,5	1.87

†Universal fitting also mates with 60° DIN 7631/7647 connections.

Metric to 37° flare

Metric 60° (DIN 7631/7647)/37° flare

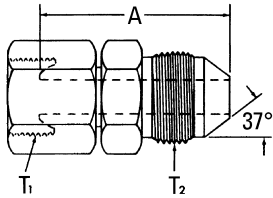

Part no. 15.165-(Dash size)

Dash size	Tube O.D.		Thread T1	Thread T2	A	
	mm	in			mm	in
20-16	25,4	1.00	M30 x 1.5	1 5/16-12	46,0	1.81
25-20	31,7	1.25	M38 x 1.5	1 5/8-12	49,5	1.95
32-24	38,1	1.50	M45 x 1.5	1 7/8-12	52,6	2.07
40-32	50,8	2.00	M52 x 1.5	2 1/2-12	61,0	2.40

SAE 37° male/metric male

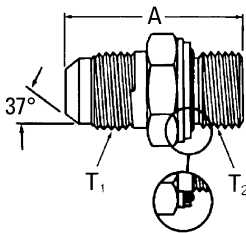

GG108-NP(Size)-(Dash size)

Dash size	Tube O.D.		Thread T1	Thread T2	A	
	mm	in			mm	in
04-10	6,4	0.25	7/16-20	M10 x 1.0	29,0	1.14
04-12	6,4	0.25	7/16-20	M12 x 1.5	33,0	1.30
05-10	7,9	0.31	1/2-20	M10 x 1.0	29,0	1.14
06-14	9,7	0.38	9/16-18	M14 x 1.5	34,0	1.34
06-16	9,7	0.38	9/16-18	M16 x 1.5	34,0	1.34
08-16	12,7	0.50	3/4-16	M16 x 1.5	37,1	1.46
08-18	12,7	0.50	3/4-16	M18 x 1.5	37,6	1.48
10-18	16,0	0.63	7/8-14	M18 x 1.5	40,1	1.58
10-20	16,0	0.63	7/8-14	M20 x 1.5	42,9	1.69
10-22	16,0	0.63	7/8-14	M22 x 1.5	42,9	1.69
12-22	19,0	0.75	1 1/16-12	M22 x 1.5	46,5	1.83
12-27	19,0	0.75	1 1/16-12	M27 x 2.0	49,5	1.95
16-33	25,4	1.00	1 5/16-12	M33 x 2.0	53,6	2.11

90° adjustable elbow SAE 37° male/metric male

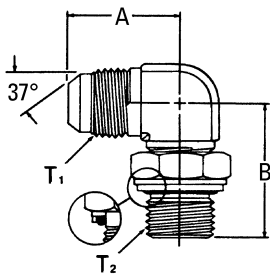

GG308-NP(Size)-(Dash size)

Dash size	Tube O.D.		Thread T1	Thread T2	A		Rø	
	mm	in			mm	in	mm	in
04-10	6,4	0.25	7/16-20	M10 x 1	22,6	0.89	25,9	1.02
04-12	6,4	0.25	7/16-20	M12 x 1.5	26,9	1.06	31,5	1.24
06-16	9,7	0.38	9/16-18	M16 x 1.5	28,5	1.12	36,6	1.44
08-16	12,7	0.50	3/4-16	M16 x 1.5	31,5	1.24	36,6	1.44
08-18	12,7	0.50	3/4-16	M18 x 1.5	31,5	1.24	36,6	1.44
10-18	16,0	0.63	7/8-14	M18 x 1.5	36,6	1.44	39,6	1.56
10-20	16,0	0.63	7/8-14	M20 x 1.5	36,6	1.44	42,9	1.69
10-22	16,0	0.63	7/8-14	M22 x 1.5	36,6	1.44	42,9	1.69
12-22	19,0	0.75	1 1/16-12	M22 x 1.5	41,9	1.65	45,5	1.79
12-27	19,0	0.75	1 1/16-12	M27 x 2.0	41,9	1.65	49,0	1.93

Adapters and tube fittings

ORS to metric

J

ORS to metric

ORS – Special metric connector (mates with DIN 3852 large spotface)

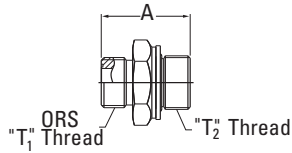

Part no. FF2485T-(Dash size)

Dash size	Tube O.D.		Thread T1	Thread T2	Ref A	
	mm	in			mm	in
0818S	12,7	0.50	13/16-16	M18 x 1.5	33,6	1.32
0822S	12,7	0.50	13/16-16	M22 x 1.5	36,3	1.43
1022S	16,0	0.63	1-14	M22 x 1.5	39,1	1.54
1633S	25,4	1.00	1 7/16-12	M33 x 2.0	48,0	1.89
2042S	31,8	1.25	1 11/16-12	M42 x 2.0	51,6	2.03

ORS/male ISO 6149 boss (S-Series)

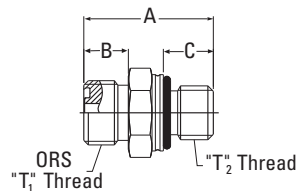

Part no. FF2742T-(Dash size) (Ref. SAE 52M0187)

Dash size	Tube O.D.		Thread T1	Thread T2	A		B		C	
	mm	in			mm	in	mm	in	mm	in
0612S	9,7	0.38	11/16-16	M12 x 1.5	32,0	1.26	11,2	0.44	10,9	0.43
0614S	9,7	0.38	11/16-16	M14 x 1.5	32,0	1.26	11,2	0.44	10,9	0.43
0822S	12,7	0.50	13/16-16	M22 x 1.5	39,4	1.55	12,7	0.50	15,0	0.59
1022S	16,0	0.63	1-14	M22 x 1.5	41,9	1.65	15,5	0.61	15,0	0.59
1222S	19,0	0.75	1 3/16-12	M22 x 1.5	43,4	1.71	17,0	0.67	15,0	0.59

45° ORS/ISO 6149 boss (S-series)

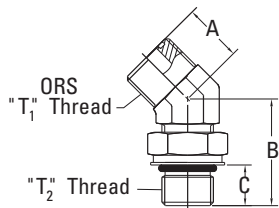

Part no. FF2743T-(Dash size) (Ref. SAE 52M0287)

Dash size	Tube O.D.		Thread T1	Thread T2	A		B		C	
	mm	in			mm	in	mm	in	mm	in
1227S	19,0	0.75	13/16-12	M27 x 2.0	25,9	1.02	50,5	1.99	18,3	0.72

90° ORS/ISO 6149 boss (S-series)

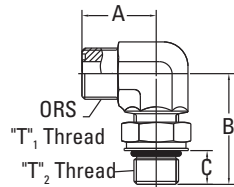

Part no. FF2744T-(Dash size) (Ref. SAE 52M0287)

Dash size	Tube O.D.		Thread T1	Thread T2	A		B		C	
	mm	in			mm	in	mm	in	mm	in
0818S	12,7	0.50	13/16-16	M18 x 1.5	29,7	1.17	44,2	1.74	14,2	0.56
1022S	16,0	0.63	1-14	M22 x 1.5	33,3	1.31	49,0	1.93	14,7	0.58

ORS/ISO 6149 boss (S-series) run tee

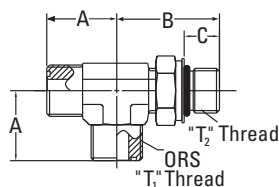

Part no. FF2746T-(Dash size) (Ref. SAE 52M0488)

Dash size	Tube O.D.		Thread T1	Thread T2	A		B		C	
	mm	in			mm	in	mm	in	mm	in
0818S	12,7	0.50	13/16-16	M18 x 1.5	27,9	1.10	40,9	1.61	14,2	0.56
1022S	16,0	0.63	1-14	M22 x 1.5	33,3	1.31	49,0	1.93	14,7	0.58
1227S	19,0	0.75	1 3/16-12	M27 x 2.0	37,3	1.47	55,6	2.19	18,3	0.72

BSPP to SAE 37° flare

BSPP (parallel)/SAE37° flare

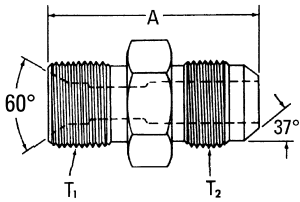

Part no. 2063-(Dash size)

Dash size	Tube O.D.		Thread T1	Thread T2	A	
	mm	in			mm	in
2-4S	6,4	0.25	1/8-28	7/16-20	35,1	1.38
4-4S	6,4	0.25	1/4-19	7/16-20	35,1	1.38
4-5S	7,9	0.31	1/4-19	1/2-20	35,1	1.38
4-6S	9,7	0.38	1/4-19	9/16-18	35,1	1.38
6-6S	9,7	0.38	3/8-19	9/16-18	36,3	1.43
6-8S	12,7	0.50	3/8-19	3/4-16	38,9	1.53
8-8S	12,7	0.50	1/2-14	3/4-16	41,4	1.63
8-10S	16,0	0.63	1/2-14	7/8-14	43,9	1.73
10-12S	19,0	0.75	5/8-14	1 1/16-12	49,3	1.94
12-10S	16,0	0.63	3/4-14	7/8-14	47,7	1.88
12-12S	19,0	0.75	3/4-14	1 1/16-12	50,5	1.99
16-16S	25,4	1.00	1-11	1 5/16-12	53,1	2.09

Note: The BSPP male end mates with a BSPP female swivel nut.
Use GG106 conversion adapters for port connections.

SAE 37° male/BSPP male

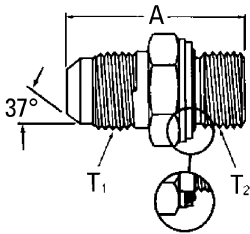

Part no. GG106-NP(Size)-(Dash size)

Dash size	Tube O.D.		Thread T1	Thread T2	A	
	mm	in			mm	in
04-02	6,4	0.25	7/16-20	G1/8-28	29,0	1.14
04-04	6,4	0.25	7/16-20	G1/4-19	34,5	1.36
04-06	6,4	0.25	7/16-20	G3/8-19	34,5	1.36
04-08	6,4	0.25	7/16-20	G1/2-14	38,1	1.50
06-04	9,7	0.38	9/16-18	G1/4-19	34,5	1.36
06-06	9,7	0.38	9/16-18	G3/8-19	34,5	1.36
06-08	9,7	0.38	9/16-18	G1/2-14	38,1	1.50
08-04	12,7	0.50	3/4-16	G1/4-19	37,6	1.48
08-06	12,7	0.50	3/4-16	G3/8-19	37,6	1.48
08-08	12,7	0.50	3/4-16	G1/2-14	40,9	1.61
08-12	12,7	0.50	3/4-16	G3/4-14	44,9	1.77
10-06	16,0	0.63	7/8-14	G3/8-19	40,4	1.59
10-08	16,0	0.63	7/8-14	G1/2-14	43,4	1.71
12-08	19,0	0.75	1 1/16-12	G1/2-14	47,0	1.85
12-12	19,0	0.75	1 1/16-12	G3/4-14	50,0	1.97
12-16	19,0	0.75	1 1/16-12	G1-11	52,6	2.07
16-12	25,4	1.00	1 1/16-12	G3/4-14	51,1	2.01
16-16	25,4	1.00	1 5/16-12	G1-11	53,6	2.11
16-20	25,4	1.00	1 5/16-12	G1 1/4-11	56,9	2.24
20-20	31,8	1.25	1 5/8-12	G1 1/4-11	58,4	2.30

Adapters and tube fittings

BSPP to SAE 37° flare,
BSPT to SAE 37° flare and JIS 30° to SAE 37° flare

J

BSPP to 37° flare

90° adjustable elbow
SAE 37° male/BSPP male

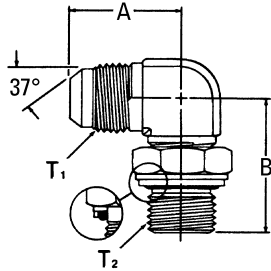

Part no. GG306-NP(Size)-(Dash size)

Dash size	Tube O.D.		Thread T1	Thread T2	A		B	
	mm	in			mm	in	mm	in
04-02	6,4	0.25	7/16-20	G1/8-28	22,6	0.89	26,4	1.04
04-04	6,4	0.25	7/16-20	G1/4-19	26,9	1.06	31,5	1.24
05-04	7,9	0.31	1/2-20	G1/4-19	26,9	1.06	31,5	1.24
06-04	9,7	0.38	9/16-18	G1/4-19	26,9	1.06	31,5	1.24
06-06	9,7	0.38	9/16-18	G3/8-19	28,5	1.12	36,6	1.44
08-06	12,7	0.50	3/4-16	G3/8-19	31,5	1.24	36,6	1.44
08-08	12,7	0.50	3/4-16	G1/2-14	34,0	1.34	42,9	1.69
10-08	16,0	0.63	7/8-14	G1/2-14	36,6	1.44	42,9	1.69
12-12	19,0	0.75	1 1/16-12	G3/4-14	41,9	1.65	49,0	1.93
16-16	25,4	1.00	1 5/16-12	G1-11	46,0	1.81	52,6	2.07
20-20	31,8	1.25	1 5/8-12	G1 1/4-11	52,0	2.05	56,9	2.24

BSPT to SAE 37° flare

SAE 37° male/BSPT male

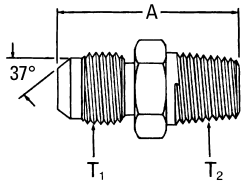

Part no. GG110-NP(Size)-(Dash size)

Dash size	Tube O.D.		Thread T1	Thread T2	A	
	mm	in			mm	in
04-02	6,4	0.25	7/16-20	R1/8-28	29,0	1.14
04-04	6,4	0.25	7/16-20	R1/4-19	33,0	1.30
06-04	9,7	0.38	9/16-18	R1/4-19	33,6	1.32
06-06	9,7	0.38	9/16-18	R3/8-19	33,6	1.32
08-06	12,7	0.50	3/4-16	R3/8-19	36,6	1.44
08-08	12,7	0.50	3/4-16	R1/2-14	40,4	1.59
10-08	16,0	0.63	7/8-14	R1/2-14	42,9	1.69
12-08	19,0	0.75	1 1/16-12	R1/2-14	47,5	1.87
12-12	19,0	0.75	1 1/16-12	R3/4-14	49,5	1.95
16-16	25,4	1.00	1 5/16-12	R1-11	52,6	2.07

90° elbow, SAE 37° male/BSPT male

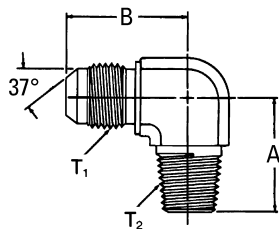

Part no. GG310-NP(Size)-(Dash size)

Dash size	Tube O.D.		Thread T1	Thread T2	A		B	
	mm	in			mm	in	mm	in
04-02	6,4	0.25	7/16-20	R1/8-28	20,6	0.81	23,4	0.92
04-04	6,4	0.25	7/16-20	R1/4-19	27,4	1.08	26,9	1.06
06-04	9,7	0.38	9/16-18	R1/4-19	27,5	1.08	27,0	1.06
06-06	9,7	0.38	9/16-18	R3/8-19	31,0	1.22	28,5	1.12
06-08	9,7	0.38	9/16-18	R1/2-14	37,1	1.46	31,0	1.22
08-06	12,7	0.50	3/4-16	R3/8-19	31,0	1.22	31,5	1.24
08-08	12,7	0.50	3/4-16	R1/2-14	37,1	1.46	34,0	1.34
12-12	19,0	0.75	1 1/16-12	R3/4-14	40,4	1.59	41,9	1.65
16-16	25,4	1.00	1 5/16-12	R1-11	50,0	1.97	46,0	1.81

JIS 30° to SAE 37° flare

Female cone seat JIS 30° female cone seat/SAE 37° male

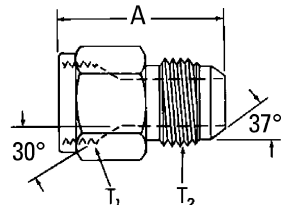

Part no. FF2593-(Dash size)

Dash size	Tube O.D.		Thread T1	Thread T2	A	
	mm	in			mm	in
0404S	6,4	0.25	G1/4-19	7/16-20	30,3	1.19
0606S	9,7	0.38	G3/8-19	9/16-18	30,7	1.21
0808S	12,7	0.50	G1/2-14	3/4-16	35,8	1.41
1212S	19,0	0.75	G3/4-14	1 1/16-12	43,2	1.70

Stainless steel adapters

Eaton stainless steel adapters are manufactured from 316 stainless steel for excellent corrosive resistance. All parts meet dimensional and performance requirements of SAE J514.

Additionally, all parts are passivated after machining to increase corrosive protection.

Applications:

- Marine/Military
- Chemical processing
- Pulp and paper industry
- Food and beverage processing
- Off-Shore drilling

Note: Stainless steel threaded products are susceptible to galling. Sealing surfaces and threads may be severely damaged due to the high pressure associated with assembly. It is recommended that a high-pressure lubricant be used to prevent galling.

Torque requirements

SAE 37° (JIC)

Dash size	Thread size (inches)	Swivel nut torque	
		ft./lbs.	Newton meters
-04	7/16-20	11-12	15-16
-05	1/2-20	15-16	20-22
-06	9/16-18	18-20	24-28
-08	3/4 -16	38-42	52-88
-10	7/8-14	57-62	77-85
-12	1 1/16-12	79-87	108-119
-16	1 5/16-12	108-113	148-154
-20	1 5/8 -12	127-133	173-182
-24	1 7/8-12	158-167	216-227
-32	2 1/2-12	245-258	334-352

Straight thread O-Rings

Low pressure with 37°
(SAE J514)

Dash size	Thread size (inches)	Swivel nut torque	
		ft./lbs.	Newton meters
-03	3/8-24	8-9	12-13
-04	7/16-20	13-15	18-20
-05	1/2-20	14-15	19-21
-06	9/16-18	23-24	32-33
-08	3/4-16	40-43	55-57
-10	7/8-14	43-48	59-64
-12	1 1/16-12	68-75	93-101
-14	1 3/16-12	83-90	113-122
-16	1 5/16-12	112-123	152-166
-20	1 5/8-12	146-161	198-218
-24	1 7/8-12	154-170	209-230
-32	2 1/2-12	218-240	296-325

Adapters and tube fittings

Stainless steel adapters

J

Pipe NPTF to NPTF

Reducer bushings

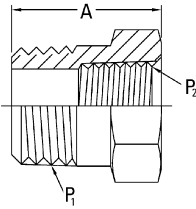

Part no. 259-2081-(Dash size)

Dash size	Thread P1	Thread P2	A	
			mm	in
6-2	3/8-18	1/8-27	21,6	0.85
6-4	3/8-18	1/4-18	25,4	1.00
8-2	1/2-14	1/8-27	27,9	1.10
8-4	1/2-14	1/4-18	27,9	1.10
12-4	3/4-14	1/4-18	29,7	1.17
12-6	3/4-14	3/8-18	29,7	1.17
12-8	3/4-14	1/2-14	34,5	1.36
16-6	1-11 1/2	3/8-18	34,5	1.36
16-8	1-11 1/2	1/2-14	34,5	1.36
16-12	1-11 1/2	3/4-14	37,8	1.49
20-12	1 1/4-11 1/2	3/4-14	37,3	1.47
24-12	1 1/2-11 1/2	3/4-14	39,9	1.57
24-16	1 1/2-11 1/2	1-11 1/2	39,9	1.57
32-16	2-11 1/2	1-11 1/2	44,4	1.75
32-20	2-11 1/2	1 1/4-11 1/2	44,4	1.75
32-24	2-11 1/2	1 1/2-11 1/2	44,4	1.75

Plugs

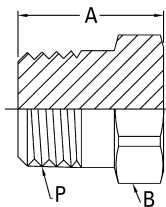

Part no. 259-2082-(Dash size)

Dash size	Thread P1	A		B	
		mm	in	mm	in
2	1/8-27	14,7	0.58	11,2	0.44
4	1/4-18	19,3	0.76	14,2	0.56
6	3/8-18	20,1	0.79	17,6	0.69
8	1/2-14	24,9	0.98	22,4	0.88
12	3/4-14	27,4	1.08	26,9	1.06
16	1-11 1/2	32,3	1.27	33,3	1.31
20	1 1/4-11 1/2	33,0	1.30	44,4	1.75
24	1 1/2-11 1/2	33,8	1.33	50,8	2.00
32	2-11 1/2	35,3	1.39	63,5	2.50

Pipe NPTF to NPTF

Hexagon pipe nipples

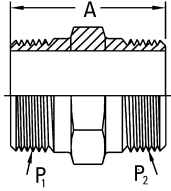

Part no. 259-2083-(Dash size)

Dash size	Thread P1	Thread P2	B	
			mm	in
4-4	1/4-18	1/4-18	36,8	1.45
6-4	3/8-18	1/4-18	36,8	1.45
6-6	3/8-18	3/8-18	36,8	1.45
8-6	1/2-14	3/8-18	43,2	1.70
8-8	1/2-14	1/2-14	48,0	1.89
12-8	3/4-14	1/2-14	49,8	1.96
12-12	3/4-14	3/4-14	49,8	1.96
16-12	1-11 1/2	3/4-14	54,6	2.15
16-16	1-11 1/2	1-11 1/2	59,4	2.34
20-16	1 1/4-11 1/2	1-11 1/2	62,2	2.45
24-24	1 1/2-11 1/2	1 1/2-11 1/2	66,3	2.61

Hexagon pipe coupling

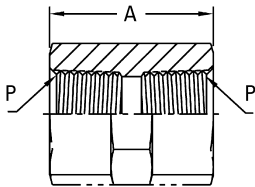

Part no. 259-2096-(Dash size)

Dash size	Thread P	A	
		mm	in
4	1/4-18	28,7	1.13
6	3/8-18	28,7	1.13
8	1/2-14	38,1	1.50
12	3/4-14	38,9	1.53
16	1-11 1/2	48,0	1.89
20	1 1/4-11 1/2	49,0	1.93
24	1 1/2-11 1/2	49,0	1.93

Adapters and tube fittings

Stainless steel adapters

J

Pipe NPT to SAE 37° Flare

Male connector

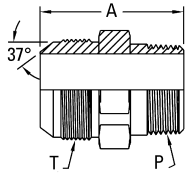

Part no. 259-2021-(Dash size)

Dash size	Tube O.D.		Thread P	Thread T	A	
	mm	in			mm	in
4-4	6,3	0.25	1/4-18	7/16-20	36,1	1.42
4-6	9,6	0.38	1/4-18	9/16-18	36,3	1.43
6-6	9,6	0.38	3/8-18	9/16-18	36,3	1.43
6-8	12,7	0.50	3/8-18	3/4-16	38,9	1.53
8-8	12,7	0.50	1/2-14	3/4-16	45,5	1.79
12-12	19,0	0.75	3/4-14	1 1/16-12	52,3	2.06
16-16	25,4	1.00	1-11 1/2	1 5/16-12	58,4	2.30
16-20	31,7	1.25	1-11 1/2	1 5/8-12	61,5	2.42
20-16	25,4	1.00	1 1/4-11 1/2	1 5/16-12	61,0	2.40
20-20	31,7	1.25	1 1/4-11 1/2	1 5/8-12	62,2	2.45

Bulkhead with jam nut

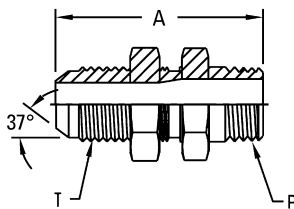

Part no. 259-2240-(Dash size)

Dash size	Tube O.D.		Thread T	Thread P	A	
	mm	in			mm	in
4-4	6,3	0.25	7/16-20	1/4-18	51,6	2.03
4-6	9,6	0.38	9/16-18	1/4-18	53,9	2.12
6-8	12,7	0.50	3/4-16	3/8-18	59,9	2.36
12-12	19,0	0.75	1 1/16-12	3/4-14	74,2	2.92
16-16	25,4	1.00	1 5/16-12	1-11 1/2	79,0	3.11

Female connector

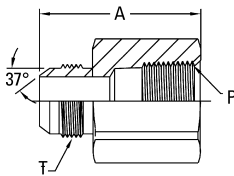

Part no. 259-2022-(Dash size)

Dash size	Tube O.D.		Thread P	Thread T	A	
	mm	in			mm	in
4-4	6,3	0.25	1/4-18	7/16-20	35,3	1.39
6-6	9,6	0.38	3/8-18	9/16-18	37,1	1.46
6-8	12,7	0.50	3/8-18	3/4-16	39,6	1.56
8-8	12,7	0.50	1/2-14	3/4-16	45,5	1.79
12-12	19,0	0.75	3/4-14	1 1/16-12	52,3	2.06
16-16	25,4	1.00	1-11 1/2	1 5/16-12	59,7	2.35
20-20	31,7	1.25	1 1/4-11 1/2	1 5/8-12	63,2	2.49
24-24	38,1	1.50	1 1/2-11 1/2	1 7/8-12	66,5	2.62

SAE 37° flare

Union

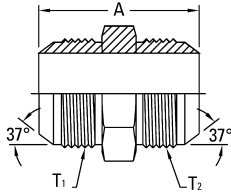

Part no. 259-2027-(Dash size)

Dash size	Tube O.D.		Thread T1	Thread T2	A	
	mm	in			mm	in
4-4	6,3	0.25	7/16-20	7/16-20	34,8	1.37
6-4	6,3	0.25	9/16-18	7/16-20	35,6	1.40
6-6	9,6	0.38	9/16-18	9/16-18	35,8	1.41
8-6	9,6	0.38	3/4-16	9/16-18	38,6	1.52
8-8	12,7	0.50	3/4-16	3/4-16	41,1	1.62
16-16	25,4	1.00	1 5/16-12	1 5/16-12	57,2	2.25
20-20	31,7	1.25	1 5/8-12	1 5/8-12	61,7	2.43
24-24	38,1	1.50	1 7/8-12	1 7/8-12	69,8	2.75

SAE O-Ring boss to SAE 37° flare

Straight thread short connector

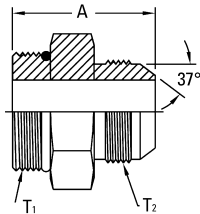

Part no. 259-202702-(Dash size)

Dash size	Tube O.D.		Thread T1	Thread T2	A	
	mm	in			mm	in
4-4	6,3	0.25	7/16-20	7/16-20	31,2	1.23
4-6	9,6	0.38	7/16-20	9/16-18	32,3	1.27
6-4	6,3	0.25	9/16-18	7/16-20	32,8	1.29
6-6	9,6	0.38	9/16-18	9/16-18	33,0	1.30
6-8	12,7	0.50	9/16-18	3/4-16	36,6	1.44
8-6	9,6	0.38	3/4-16	9/16-18	35,1	1.38
8-8	12,7	0.50	3/4-16	3/4-16	37,6	1.48
12-12	19,0	0.75	1 1/16-12	1 1/16-12	50,0	1.97
12-16	25,4	1.00	1 1/16-12	1 5/16-12	51,8	2.04
16-12	19,0	0.75	1 5/16-12	1 1/16-12	50,5	1.99
16-16	25,4	1.00	1 5/16-12	1 5/16-12	51,8	2.04
16-20	31,7	1.25	1 5/16-12	1 5/8-12	59,2	2.33
20-16	25,4	1.00	1 5/8-12	1 5/16-12	53,9	2.12
20-20	31,7	1.25	1 5/8-12	1 5/8-12	55,2	2.17
20-24	38,1	1.50	1 5/8-12	1 7/8-12	64,3	2.53
24-20	31,7	1.25	1 7/8-12	1 5/8-12	56,9	2.24
24-24	38,1	1.50	1 7/8-12	1 7/8-12	60,2	2.37

Adapters and tube fittings

Stainless steel adapters

J

SAE 37° flare nuts and sleeves

Nuts

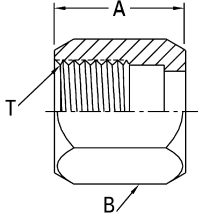

Part no. 259-1290-(Dash size)

Dash size	Tube O.D.		Thread P	Thread T	A	
	mm	in			mm	in
4	6,3	0.25	7/16-20	0.62	14,2	0.56
6	9,6	0.38	9/16-18	0.72	17,6	0.69
8	12,7	0.50	3/4-16	0.84	22,4	0.88
10	16,0	0.63	7/8-14	0.97	25,4	1.00
12	19,0	0.75	1 1/16-12	1.02	31,8	1.25
16	25,4	1.00	1 5/16-12	1.12	38,1	1.50
20	31,7	1.25	1 5/8-12	1.22	50,8	2.00
24	38,1	1.50	1 7/8-12	1.41	57,2	2.25

Sleeves

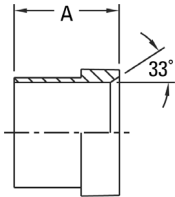

Part no. 259-900605-(Dash size)

Dash size	Tube O.D.		A	
	mm	in	mm	in
4	6,3	0.25	10,4	0.41
6	9,6	0.38	12,7	0.50
8	12,7	0.50	14,2	0.56
10	16,0	0.63	16,8	0.66
12	19,0	0.75	17,6	0.69
16	25,4	1.00	19,8	0.78
20	31,7	1.25	23,1	0.91
24	38,1	1.50	28,5	1.12

7000 series Ermeto

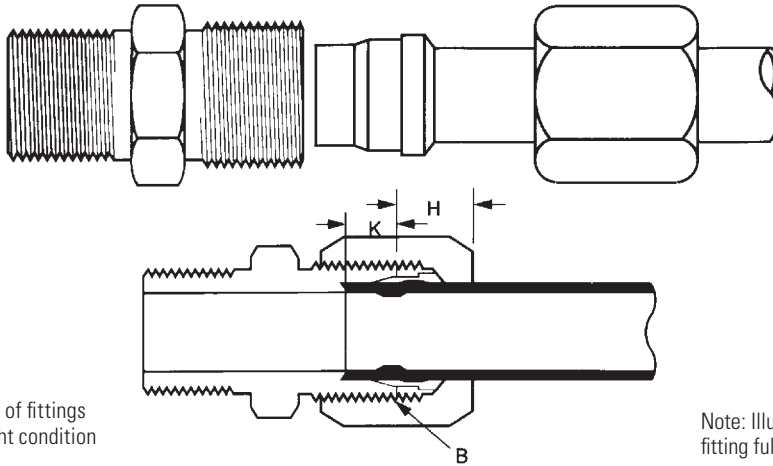

Note: "H" is dimension of fittings assembled to hand tight condition

Note: Illustration shows fitting fully assembled.

Tube O.D.	1/8	3/16	1/4	5/16	3/8	1/2	5/8	3/4	7/8	1	1 1/4	1 1/2	2
Thread size-B	5/16-24	3/8-24	7/16-20	1/2-20	9/16-18	3/4-16	7/8-14	1 1/16-12	1 3/16-12	1 5/16-12	1 5/8-12	1 7/8-12	2 1/2-12
Seat depth-K	0.19	0.24	0.24	0.26	0.26	0.31	0.36	0.36	0.36	0.42	0.42	0.49	0.49
H (Ref.)	0.31	0.30	0.39	0.41	0.47	0.48	0.53	0.55	0.53	0.63	0.56	0.61	0.64

Typical application

Hydraulic, instrumentation and chemical processing systems. Highly recommended for high pressure applications

Pressure

Operating pressure up to 10,000 psi depending on tube and fitting size. See steel fittings recommendations, page J-111

Vibration

Excellent resistance

Temperature range

-65°F to +400°F (-53°C to +204°C) at maximum operating pressures. Has been used at 800°F and 1000 psi to 4000 psi depending on tube size.

Material

Carbon Steel Plating - Zinc Trivalent

Advantages

An excellent high pressure fitting - NO TUBE FLARING. Used with extra heavy wall tubing. Broad selection of sizes and styles

Conformance

Meets specifications and standards of ASME and SAE

How to order

For complete assembly (body, nut sleeve) order individually by part number. Example: 7205x4. To order body only (less nut and sleeve), prefix the part number with the letter Example: B7205X4. Nuts and sleeves can be ordered separately by part number

Adapters and tube fittings

7000 series Ermeto fittings

J

7000 series Ermeto fittings

Ermeto fittings (7000 Series) are especially designed for making leak-proof tube connections. This fitting will effectively withstand high pressure, severe vibration and extreme temperature. No special tools are needed for assembly. Simply cut tube square, preset sleeve on tubing and assemble.

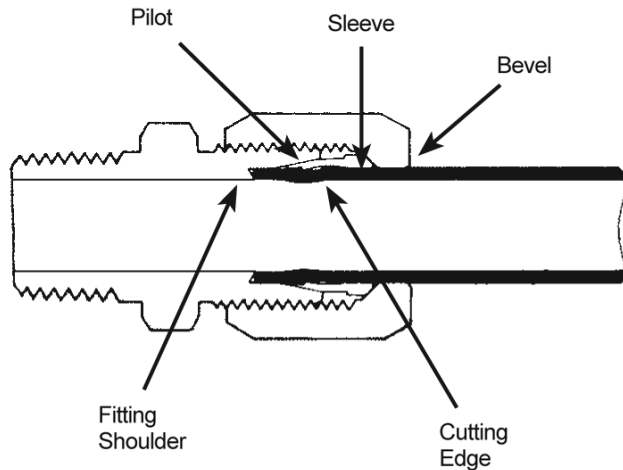

7000 series fittings

Specifically designed to meet all SAE approved standards for hydraulic flareless tube fittings. Available in a complete range of standard body styles.

Carbon steel 7000 series

Eaton Ermeto fittings have a zinc trivalent finish, which fully resists the effects of nonflammable hydraulic fluids.

Ermeto design principle provides positive seal

1. In presetting, as the nut is tightened it forces the sleeve forward into the body taper. See page J-109 for preset instructions.
2. Pilot of sleeve contracts, forcing the cutting edge of sleeve to shear a groove into outer surface of the tube, making a tight joint between fitting and tube.
3. In assembling the preset sleeve and tube into the fitting body, the nut presses on the bevel at rear of sleeve causing it to clamp tightly to the tube. Resistance to vibration is concentrated at this point rather than at the sleeve cut.
4. When fully tightened, the case hardened sleeve is bowed slightly at the midsection and acts as a spring. This spring action of the sleeve maintains a constant tension between the body and the nut, and thus prevents the nut from loosening.
5. After the first assembly, the sleeve is permanently attached to the tube. Disassembly and reassembly of the fitting can be made without loss of strength or sealing qualities.

In general, the "bite-action" of the sleeves in any given material varies as shown in the following table:

"7000" Series Sleeve	Sleeve Material	Tubing used 303 to 316 Stainless and Cupro-Nickel	"Bite-action"
7165	Heat treated carbon steel (standard carbon)	Fully annealed to 1/8 hard	Excellent

7000 series Ermeto fittings Assembly instructions

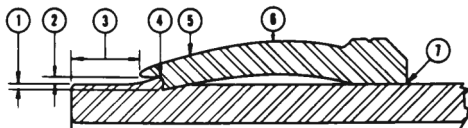
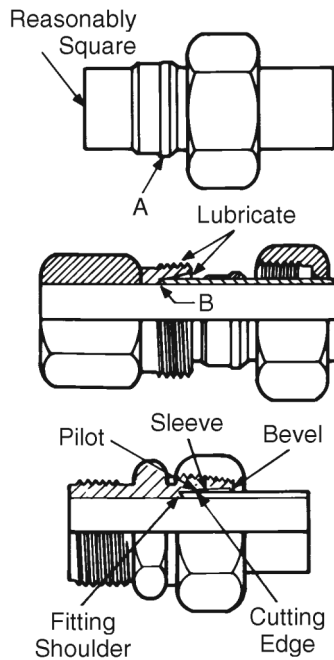

Presetting operation

Preset with preset tool:

1. Slide nut and then sleeve on tube. Shoulder of sleeve "A" must be toward nut.
2. Insert tube into presetting tool. Be sure that tube is bottomed on fitting tube stop at point "B". Lubricate threads, seat of fitting and shoulder of sleeve with good grade of lubricant.
3. Turn nut slowly with wrench while turning tube with other hand. When the sleeve grips the tube, that is, when the tube can no longer be turned by hand - STOP - and note the position of the wrench. This is the "Ring Grip" point.
4. Tighten nut an additional number of turns past the ring grip point per tube size and wall thickness as shown in Table 1, page J-110.
5. Disassemble from preset tool.

Preset in fitting body:

Follow same procedure as when presetting with preset tool. Once the fitting nut has been turned the proper number of turns past ring grip, the fitting assembly is complete and ready for use.

Fitting installation

1. After sleeve and nut have been preset on the tubing and checked as described, the assembly is ready for installation into the Ermeto fitting seat.
2. Lubricate threads, seat of fitting and shoulder of sleeve with a good grade of lubricant compatible with system fluid.
3. Insert tube assembly into fitting and tighten nut until sharp rise in torque is felt.
4. Starting at the position of sharp torque rise, tighten nut 1/4 turn to complete assembly.

When the assembly procedure for Ermeto fittings is followed correctly, these points will be evident:

1. Cutting edge of sleeve will be imbedded in tubing to its full depth.
2. Pilot edge of sleeve should be close to or touching O.D. of tubing.
3. Distance between end of tube and leading or pilot edge of sleeve will be at least 1/8".
4. Metal will be piled ahead of cutting edge of sleeve under pilot.
5. Contact area of sleeve will show evidence of being in perfect contact with tapered seat of fitting.
6. Sleeve will show evidence of being bowed within its elastic limits.
7. Back of sleeve will be in contact with tube.

Note: Performance of fitting will not be affected if sleeve rotates on tube after disassembly.

For re-installation of fitting after disassembly

1. Insert tube assembly into fitting, tighten nut until a sharp rise in torque is felt.
2. Starting at the position of sharp torque rise, tighten nut 1/4 turn to complete the reinstallation.

Adapters and tube fittings

Presetting Ermeto fittings

J

Presetting Ermeto fittings

Table 1: Number of additional turns from “Ring grip” for hand presetting operation—Ermeto sleeve

Tube Size	Tube Material**	Tube wall thickness									
		.018	.022	.028	.035	.049	.065	.083	.095	.109	.120
2	C 1010	1-1/6	1-1/6	1-1/6	1-1/6						
	MiL-T-8504	1-1/6	1-1/6	1-1/6	1-1/6						
3	C 1010	1-1/6	1-1/6	1-1/6	1						
	MiL-T-8504	1-1/6	1-1/6	1-1/6	1						
4	C 1010			1-1/6	1-1/6	1-1/6	1				
	MiL-T-8504			1-1/6	1	1	5/6				
5	C 1010			1-1/6	1-1/6	1-1/6	1				
	MiL-T-8504			1-1/6	1-1/6	1	1				
6	C 1010				1-1/6	1-1/6	1	1			
	MiL-T-8504				1-1/6	5/6	5/6	1			
8	C 1010				1-1/6	1-1/6	1	1	1		
	MiL-T-8504				1-1/6	1	5/6	5/6	5/6		
10	C 1010					1-1/6	1	5/6	5/6	5/6	5/6
	MiL-T-8504					1-1/6	1	5/6	5/6	5/6	5/6
12	C 1010					1	1	5/6	5/6	5/6	
	MiL-T-8504					1-1/6	1	5/6	5/6	5/6	
16	C 1010					1-1/6	1-1/6	5/6	5/6	5/6	
	MiL-T-8504					1-1/6	1-1/6	1-1/6	5/6	5/6	5/6
20	C 1010						1	1	1	5/6	5/6
	MiL-T-8504						1	1	1	5/6	5/6
24	C 1010								1	1	1
	MiL-T-8504										
32	C 1010								1	1	1
	MiL-T-8504										

** C 1010 – carbon steel tubing

** MiL-T-8504 – Annealed stainless steel

Ermeto hand presetting tools 7000 series



Presetting tools provide a more accurate and positive leak-proof method of coupling flareless fittings. Presetting steel Ermeto sleeves on tubing prior to fitting assembly will permit the maximum high performance obtainable with flareless fittings.

Catalog number	Tube O.D.	Thread size
	inches	
T-7002	1/8	5/16-24
T-7003	3/16	3/8-24
T-7004	1/4	7/16-20
T-7005	5/16	1/2-20
T-7006	3/8	9/16-18
T-7008	1/2	3/4-16
T-7010	5/8	7/8-14
T-7012	3/4	1 1/16-12
T-7016	1	1 5/16-12
T-7020	1 1/4	1 5/8-12
T-7024	1 1/2	1 7/8-12
T-7032	2	2 1/2-12

Metric flareless hand presetting tools

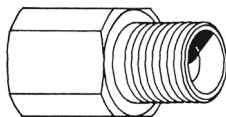

Presetting tools provide a more accurate and positive leak-proof method of coupling flareless fittings. Presetting the steel metric sleeves prior to fitting assembly will permit the maximum high performance obtainable with flareless fittings. These tools are available for the Light (DIN 3901/3902L) flareless series.

Light series 3901/3902L

Catalog number	Tube O.D.	Thread size
	mm	
TL-7008	8	M14x1.5
TL-7010	10	M16x1.5
TL-7012	12	M18x1.5
TL-7015	15	M22x1.5
TL-7018	18	M26x1.5
TL-7022	22	M30x2.0
TL-7028	28	M36x2.0

Ermeto flareless fittings

Hydraulic pressure data

Ermeto fittings have been used with success on many and varied applications far exceeding the conservative conditions presented below. Specifically:

- Temperatures up to 800°F, in carbon steel have been handled without failure
- Burst pressures up to 32,000 psi with 1/4" tubing
- Vibration conditions of 1/8" off-center amplitude with 12" overhang in 1/4" tubing have been withstood at rated operating pressure with 4-to-1 safety factors for over ten million cycles

Obviously under extreme conditions of pressure, temperature and/or vibration, the safety factor is proportionately reduced.

The Ermeto flareless fitting is the ultimate hydraulic fitting available today. Special performance conditions as outlined can be accommodated; however, it is recommended that your local Eaton representative be consulted for engineering assistance prior to finalizing design.

The values shown in the following table are pressure ratings of Ermeto flareless fittings under various surge conditions. They apply and are recommended for conservative operating conditions.

Size no.	Size in inches	Maximum pressure † No surges PSI	Maximum pressure † With surges to 50%	Maximum pressure † With surges of 50% to 100%	Maximum pressure † With surges to 150%
2	1/8	10,000	6,500	5,000	4,000
3	3/16	9,000	6,000	4,500	3,600
4	1/4	8,000	5,250	4,000	3,200
5	5/16	8,000	5,250	4,000	3,200
6	3/8	7,500	5,000	3,750	3,000
8	1/2	7,000	4,500	3,500	2,700
10	5/8	5,000	3,250	2,500	2,000
12	3/4	5,000	3,250	2,500	2,000
14	7/8	3,750	2,500	1,800	1,500
16	1	3,600	2,400	1,800	1,400
20	1 1/4	3,200	2,100	1,600	1,275
24	1 1/2	3,000	2,000	1,500	1,200
32	2	2,750	1,800	1,350	1,100

†Pressures shown do not apply to pneumatic applications.

Adapters and tube fittings

Ermeto

J

Ermeto

Sleeve

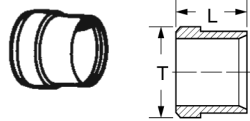

Part no. 7165x (Ref. SAE No. 080115B)

Part Number	Tube O.D.	L	Dia. T
7165x2	1/8	0.28	0.20
7165x3	3/16	0.28	0.31
7165x4	1/4	0.34	0.36
7165x5	5/16	0.34	0.42
7165x6	3/8	0.38	0.48
7165x8	1/2	0.38	0.63
7165x10	5/8	0.42	0.75
7165x12	3/4	0.42	0.88
7165x14	7/8	0.42	1.00
7165x16	1	0.42	1.13
7165x20	1 1/4	0.42	1.41
7165x24	1 1/2	0.42	1.66
7165x32	2	0.45	2.19

Sleeve

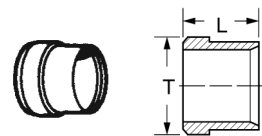

Part no. 8165x

Part Number	Tube O.D.	L	Dia. T
8165x4	1/4	0.34	0.38
8165x5	5/16	0.34	0.44
8165x6	3/8	0.38	0.50

For use with diesel nuts only.

Nut

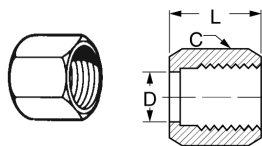

Part no. 7105x (Ref. SAE No. 080110)

Part number	Tube O.D.	Hex C	L	D Dia
7105x2	1/8	3/8	0.53	0.132
7105x3	3/16	7/16	0.61	0.195
7105x4	1/4	9/16	0.70	0.257
7105x5	5/16	5/8	0.72	0.320
7105x6	3/8	1 1/16	0.75	0.382
7105x8	1/2	7/8	0.84	0.508
7105x10	5/8	1	0.92	0.634
7105x12	3/4	1 1/4	0.97	0.759
7105x14	7/8	1 3/8	1.00	0.884
7105x16	1	1 1/2	1.05	1.009
7105x20	1 1/4	2	1.05	1.263
7105x24	1 1/2	2 1/4	1.03	1.513
7105x32	2	2 7/8	1.12	2.017

Diesel nut

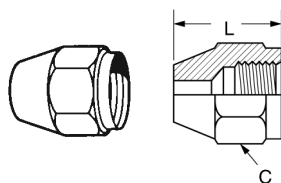

Part no. 8112x

Part number	Tube O.D.	Thread number	Hex C	L
8112x4	1/4	9/16-18	3/4	.94
8112x5	5/16	5/8-18	1 3/16	1.00
8112x6	3/8	3/4-16	1 5/16	1.13

Note: All measurements are in inches.

Ermeto

Cap

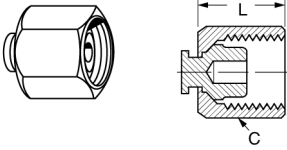

Part no. 7129x (Ref. SAE No. 080112)

Part number	Tube O.D	Hex C	L
7129x4	1/4	9/16	0.70
7129x6	3/8	1 1/16	0.75
7129x8	1/2	7/8	0.84
7129x10	5/8	1	0.92
7129x12	3/4	1 1/4	0.97
7129x16	1	1 1/2	1.05
7129x20	1 1/4	2	1.05

Plug

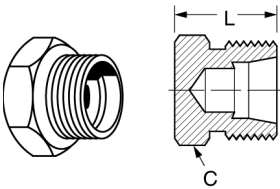

Part no. 7229x (Ref. SAE No. 080109)

Part number	Tube O.D	Hex C	L
7229x2	1/8	7/16	0.63
7229x4	1/4	1/2	0.71
7229x5	5/16	9/16	0.71
7229x6	3/8	5/8	0.75
7229x8	1/2	1 3/16	0.85
7229x10	5/8	1 5/16	0.97
7229x12	3/4	1 1/8	1.10
7229x16	1	1 3/8	1.10

Reducer

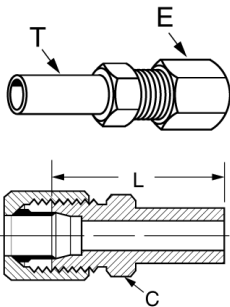

Part no. 7015x (Ref. SAE No. 080123)

Part number	Body size T	Tube size T	Hex C	L
7015x6x4	13/8	1/4	1/2	1.61
7015x8x4	1/2	1/4	9/16	1.73
7015x8x6	1/2	3/8	5/8	1.77
7015x10x8	5/8	1/2	1 3/16	1.96
7015x12x6	3/4	3/8	1 3/16	1.93
7015x12x8	3/4	1/2	1 3/16	2.03
7015x16x12	1	3/4	1 1/8	2.24
7015x20x16	1 1/4	1	1 3/8	2.28

Note: All measurements are in inches.

Adapters and tube fittings

Ermeto

J

Ermeto

Small hex union

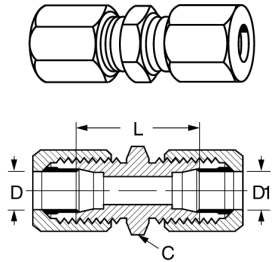

Part no. 7305x (Ref. SAE No. 080101)

Part number	Tube O.D.	Hex C	D	D1	L
7305x2	1/8	7/16	0.093	0.093	1.02
7305x3	3/16	7/16	0.125	0.125	1.11
7305x4	1/4	1/2	0.203	0.203	1.18
7305x5	5/16	9/16	0.234	0.234	1.18
7305x6	3/8	5/8	0.281	0.281	1.24
7305x6x4	3/8	5/8	0.281	0.203	1.22
7305x8	1/2	13/16	0.422	0.422	1.42
7305x8x6	1/2	13/16	0.422	0.281	1.33
7305x10	5/8	15/16	0.500	0.500	1.61
7305x12	3/4	1 1/8	0.656	0.656	1.81
7305x14	7/8	1 1/4	0.718	0.718	1.81
7305x16	1	1 3/8	0.875	0.875	1.81
7305x20	1 1/4	1 11/16	1.093	1.093	1.89
7305x24	1 1/2	2	1.344	1.344	1.96
7305x32	2	2 5/8	1.813	1.813	2.11

Large hex union

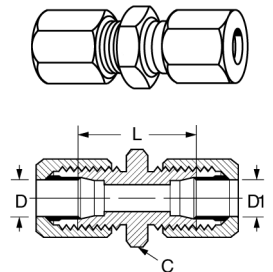

Part no. 7306x (Ref. SAE No. 080119)

Part number	Tube O.D.	Hex C	D	D1	L
7306x4	1/4	11/16	0.203	0.203	1.18
7306x6	3/8	13/16	0.281	0.281	1.24
7306x8	1/2	1	0.422	0.281	1.33
7306x8x6	1/2	1	0.422	0.422	1.42
7306x12	3/4	1 3/8	0.656	0.656	1.81
7306x16	1	1 5/8	0.875	0.875	1.81

Bulkhead union

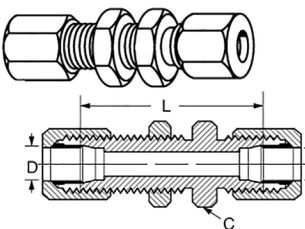

Part no. 7325x (Ref. SAE No. 080601)

Bulkhead nut included, for replacement nuts use C5924x

Part number	Tube O.D.	Hex C	D	L
7325x4	1/4	11/16	0.203	1.89
7325x6	3/8	13/16	0.281	1.98
7325x8	1/2	1	0.422	2.22
7325x12	3/4	1 3/8	0.656	2.72
7325x16	1	1 5/8	0.875	2.72

Note: All measurements are in inches.

Ermeto

Male connector

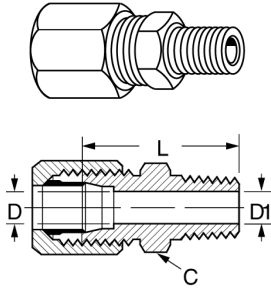

Part no. 7205x (Ref. SAE No. 080102)

Part number	Tube O.D.	Male pipe thread	Hex C	D1 D	Opt.	L
7205x2	1/8	1/8	7/16	0.093	0.188	1.04
7205x2X4	1/8	1/4	9/16	0.093	0.281	1.25
7205x3	3/16	1/8	7/16	0.125	0.188	1.09
7205x4	1/4	1/8	1/2	0.203	0.188	1.12
7205x4X4	1/4	1/4	9/16	0.203	0.281	1.32
7205x4X6	1/4	3/8	3/4	0.203	0.406	1.33
7205x4X8	1/4	1/2	7/8	0.203	0.531	1.58
7205x5	5/16	1/8	9/16	0.234	0.188	1.12
7205x5X4	5/16	1/4	9/16	0.234	0.281	1.32
7205x6	3/8	1/4	5/8	0.281	0.281	1.34
7205x6X2	3/8	1/8	5/8	0.281	0.188	1.15
7205x6X6	3/8	3/8	3/4	0.281	0.406	1.35
7205x6X8	3/8	1/2	7/8	0.281	0.531	1.60
7205x8	1/2	3/8	13/16	0.422	0.406	1.44
7205x8X4	1/2	1/4	13/16	0.422	0.281	1.44
7205x8X8	1/2	1/2	7/8	0.422	0.531	1.69
7205x8X12	1/2	3/4	1 1/8	0.422	0.719	1.76
7205x10	5/8	1/2	15/16	0.500	0.531	1.75
7205x10X6	5/8	3/8	15/16	0.500	0.406	1.56
7205x12	3/4	1/2	1 1/8	0.656	0.531	1.88
7205x12X8	3/4	3/4	1 1/8	0.656	0.719	1.88
7205x14	7/8	3/4	1 1/4	0.718	0.719	1.88
7205x16	1	1	1 3/8	0.875	0.938	2.07
7205x16X12	1	3/4	1 3/8	0.875	0.719	1.88
7205x20	1 1/4	1 1/4	1 11/16	1.093	1.250	2.18
7205x24	1 1/2	1 1/2	2	1.344	1.500	2.28
7205x32	2	2	2 5/8	1.813	1.938	2.46

Female connector

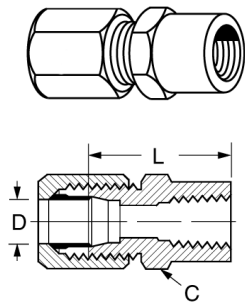

Part no. 7255x (Ref. SAE No. 080103)

Part number	Fern Tube O.D.	Pipe thread	Hex C	D	L
7255x2	1/8	1/8	9/16	0.093	1.05
7255x3	3/16	1/8	9/16	0.125	1.08
7255x4	1/4	1/8	9/16	0.203	1.09
7255x4x4	1/4	1/4	3/4	0.203	1.20
7255x5	5/16	1/8	9/16	0.234	1.08
7255x6	3/8	1/4	3/4	0.281	1.31
7255x6x6	3/8	3/8	7/8	0.281	1.40
7255x8	1/2	3/8	7/8	0.422	1.47
7255x8x4	1/2	1/4	7/8	0.422	1.38
7255x8x8	1/2	1/2	1 1/8	0.422	1.63
7255x10	5/8	1/2	1 1/8	0.500	1.76
7255x12	3/4	3/4	1 3/8	0.656	1.89
7255x14	7/8	3/4	1 3/8	0.718	1.86
7255x16	1	1	1 5/8	0.875	2.13
7255x20	1 1/4	1 1/4	2	1.093	2.22

Note: All measurements are in inches.

Adapters and tube fittings

Ermeto

J

Ermeto

Straight thread O-Ring connector

Part no. 7315x (Ref. SAE No. 080120)

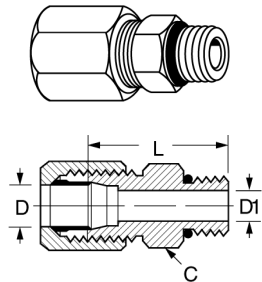

Part number	Tube O.D.	Port size	Hex C	D	L	D1 opt.
7315x3	3/16	3/16	1/2	0.125	1.04	-
7315x4	1/4	1/4	9/16	0.203	1.13	-
7315x4x5	1/4	5/16	5/8	0.203	1.13	-
7315x4x6	1/4	3/8	11/16	0.203	1.19	0.281
7315x5	5/16	5/16	5/8	0.234	1.13	-
7315x6	3/8	3/8	11/16	0.281	1.21	-
7315x6x8	3/8	1/2	7/8	0.281	1.29	0.422
7315x8	1/2	1/2	7/8	0.422	1.38	-
7315x8x10	1/2	5/8	1	0.422	1.51	0.500
7315x8x12	1/2	3/4	1 1/4	0.422	1.67	0.656
7315x10	5/8	5/8	1	0.500	1.57	-
7315x12	3/4	3/4	1 1/4	0.656	1.79	-
7315x12x16	3/4	1	1 1/2	0.656	1.82	0.876
7315x14	7/8	7/8	1 3/8	0.718	1.79	-
7315x16	1	1	1 1/2	0.875	1.82	-
7315x16x12	1	3/4	1 1/2	0.875	1.82	0.656
7315x20	1 1/4	1 1/4	1 7/8	1.093	1.90	-
7315x24	1 1/2	1 1/2	2 1/8	1.344	1.97	-
7315x32	2	2	2 3/4	1.813	2.13	-

45° male elbow

Part no. 7355x (Ref. SAE No. 080302)

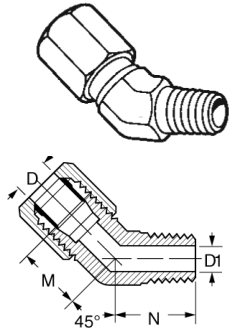

Part number	Tube O.D.	Male pipe thread	D	D1	M	N	Across flats
7355x4	1/4	1/8	0.203	0.188	0.70	0.64	7/16
7355x4x4	1/4	1/4	0.203	0.281	0.83	0.86	9/16
7355x5	5/16	1/8	0.234	0.188	0.75	0.64	9/16
7355x6	3/8	1/4	0.281	0.281	0.83	0.86	9/16
7355x8	1/2	3/8	0.422	0.406	0.98	0.95	3/4
7355x10	5/8	1/2	0.500	0.531	1.08	1.17	7/8
7355x12	3/4	3/4	0.656	0.719	1.27	1.20	1 1/16
7355x16	1	1	0.875	0.938	1.36	1.48	1 5/16

90° union elbow

Part no. 7505x (Ref. SAE No. 080201)

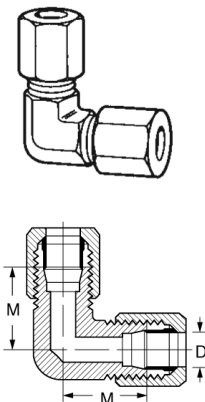

Part number	Tube O.D.	D	M	Across flats
7505x4	1/4	0.203	0.89	7/16
7505x5	5/16	0.234	0.95	1/2
7505x6	3/8	0.281	1.05	9/16
7505x8	1/2	0.422	1.25	3/4
7505x10	5/8	0.500	1.42	7/8
7505x12	3/4	0.656	1.58	1 1/16
7505x14	7/8	0.718	1.66	1 5/16
7505x16	1	0.875	1.73	1 5/16
7505x20	1 1/4	1.093	1.89	1 5/8
7505x24	1 1/2	1.346	2.02	1 7/8

Note: Available in stainless steel. All measurements are in inches.

Ermeto

90° male elbow

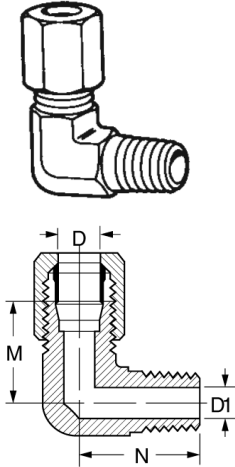

Part no. 7405x (Ref. SAE No. 080202)

Part number	Tube O.D.	Male Pipe thread	D	D1	M	N	Across flats
7405x2	1/8	1/8	0.093	0.188	0.77	0.72	7/16
7405x3	3/16	1/8	0.125	0.188	0.83	0.72	7/16
7405x4	1/4	1/8	0.203	0.188	0.89	0.78	7/16
7405x4x4	1/4	1/4	0.203	0.281	1.03	1.09	9/16
7405x5	5/16	1/8	0.234	0.188	0.95	0.81	1/2
7405x5x4	5/16	1/4	0.234	0.281	1.03	1.09	9/16
7405x6	3/8	1/4	0.281	0.281	1.05	1.09	9/16
7405x6x2	3/8	1/8	0.281	0.188	1.05	0.90	9/16
7405x6x6	3/8	3/8	0.281	0.406	1.16	1.22	3/4
7405x6x8	3/8	1/2	0.281	0.531	1.24	1.47	7/8
7405x8	1/2	3/8	0.422	0.406	1.25	1.22	3/4
7405x8x4	1/2	1/4	0.422	0.281	1.25	1.22	3/4
7405x8x8	1/2	1/2	0.422	0.531	1.35	1.47	7/8
7405x10	5/8	1/2	0.500	0.531	1.42	1.47	7/8
7405x10x6	5/8	3/8	0.500	0.406	1.42	1.28	7/8
7405x12	3/4	3/4	0.656	0.719	1.58	1.59	1 1/16
7405x12x8	3/4	1/2	0.656	0.531	1.58	1.59	1 1/16
7405x14	7/8	3/4	0.718	0.719	1.62	1.69	1 5/16
7405x16	1	1	0.875	0.938	1.73	1.97	1 5/16
7405x16x12	1	3/4	0.875	0.719	1.73	1.78	1 5/16
7405x20	1 1/4	1 1/4	1.093	1.250	1.89	2.38	1 5/8
7405x24	1 1/2	1 1/2	1.344	1.500	2.02	2.64	1 7/8
7405x32	2	2	1.813	1.938	2.45	3.00	2 9/16

90° female elbow

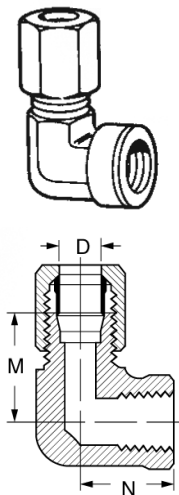

Part no. 7455x (Ref. SAE No. 080203)

Part number	Tube O.D.	Female Pipe thread	D	M	N	Across flats
7455x4	1/4	1/8	0.203	0.89	0.66	9/16
7455x4x4	1/4	1/4	0.203	1.03	0.88	3/4
7455x6	3/8	1/4	0.281	1.05	0.88	3/4
7455x6x6	3/8	3/8	0.281	1.14	1.02	7/8
7455x8	1/2	3/8	0.422	1.23	1.02	7/8
7455x8x8	1/2	1/2	0.422	1.35	1.23	1 1/16
7455x10	5/8	1/2	0.500	1.42	1.23	1 1/16
7455x12	3/4	3/4	0.656	1.58	1.36	1 5/16
7455x14	7/8	3/4	0.718	1.66	1.42	1 5/16
7455x16	1	1	0.875	1.73	1.62	1 5/8

Note: All measurements are in inches.

Adapters and tube fittings

Ermeto

J

Ermeto

90° elbow - straight thread O-Ring

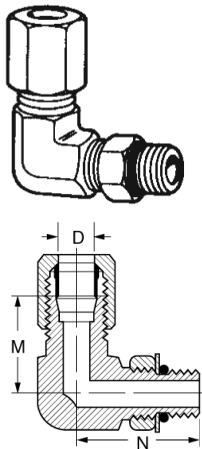

Part no. 7515x (Ref. SAE No. 080220)

Part number	Tube O.D.	Port size	D	M	N	Across flats
7515x4	1/4	1/4	0.203	0.89	1.03	7/16
7515x6	3/8	3/8	0.281	1.05	1.25	9/16
7515x8	1/2	1/2	0.422	1.25	1.45	3/4
7515x10	5/8	5/8	0.500	1.42	1.70	7/8
7515x12	3/4	3/4	0.656	1.58	1.94	1 1/16
7515x16	1	1	0.875	1.73	2.05	1 5/16
7515x20	1 1/4	1 1/4	1.093	1.89	2.25	1 5/8

Union tee

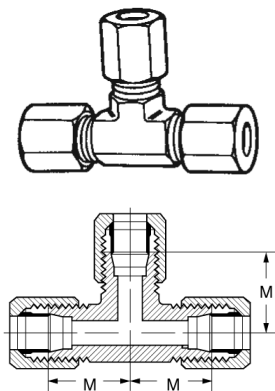

Part no. 7705x (Ref. SAE No. 080401)

Part number	Tube O.D.	D	M	Across flats
7705x3	3/16	0.125	0.83	7/16
7705x4	1/4	0.203	0.89	7/16
7705x5	5/16	0.234	0.95	9/16
7705x6	3/8	0.281	1.05	9/16
7705x8	1/2	0.422	1.25	3/4
7705x10	5/8	0.500	1.42	7/8
7705x12	3/4	0.656	1.58	1 1/16
7705x14	7/8	0.718	1.62	1 5/16
7705x16	1	0.875	1.73	1 5/16

Male run tee

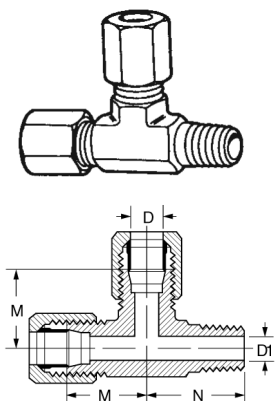

Part no. 7755x (Ref. SAE No. 080424)

Part number	Tube O.D.	Male pipe thread	D	D1	M	N	Across flats
7755x4	1/4	1/8	0.203	0.188	0.89	0.78	7/16
7755x4x4x4	1/4	1/4	0.203	0.281	1.03	1.09	9/16
7755x6	3/8	1/4	0.281	0.281	1.05	1.09	9/16
7755x8	1/2	3/8	0.422	0.422	1.25	1.22	3/4
7755x8x8x8	1/2	1/2	0.422	0.531	1.35	1.47	7/8
7755x10	5/8	1/2	0.500	0.531	1.42	1.47	7/8
7755x12	3/4	3/4	0.656	0.719	1.58	1.59	1 1/16
7755x16	1	1	0.875	0.938	1.73	1.97	1 5/16

Note: All measurements are in inches.

Ermeto

Female run tee

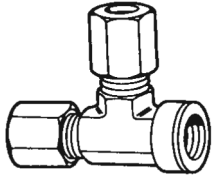

Part no. 7805x (Ref SAE No. 080426)

Part number	Tube O.D.	Female pipe thread	D	M	N	Across flats
7805x4	1/4	1/8	0.203	0.89	0.66	9/16
7805x6	3/8	1/4	0.281	1.05	0.88	3/4
7805x8	1/2	3/8	0.422	1.23	1.02	7/8

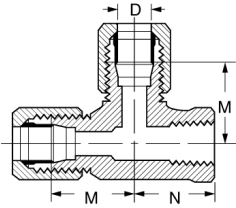

Straight thread O-Ring run tee

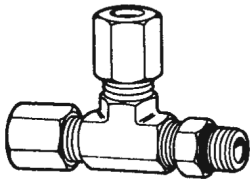

Part no. 7716x (Ref. SAE No. 080428)

Part number	Tube O.D.	Port size	D	M	N	Across flats
7716x4	1/4	1/4	0.203	0.89	1.03	7/16
7716x6	3/8	3/8	0.281	1.05	1.25	9/16

Note: All measurements are in inches.

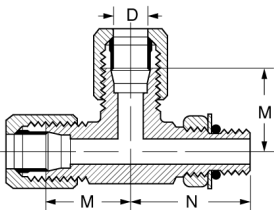

Adapters and tube fittings

Ermeto

J

Ermeto

Male branch tee

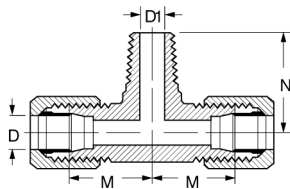
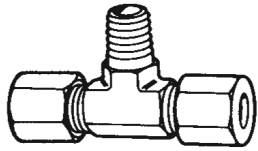

Part no. 7605x (Ref. SAE No. 080425)

Part number	Tube O.D.	Male pipe thread	D	D1	M	N	Across flats
7605x4	1/4	1/8	0.203	0.188	0.89	0.78	7/16
7605x4x4x4	1/4	1/4	0.203	0.281	1.03	1.09	9/16
7605x5	5/16	1/8	0.234	0.188	0.95	0.81	9/16
7605x6	3/8	1/4	0.281	0.281	1.05	1.09	9/16
7605x8	1/2	3/8	0.422	0.406	1.25	1.22	3/4
7605x8x8x8	1/2	1/2	0.422	0.531	1.35	1.47	7/8
7605x10	5/8	1/2	0.500	0.531	1.42	1.47	7/8
7605x12	3/4	3/4	0.656	0.719	1.58	1.59	1 1/16
7605x16	1	1	0.875	0.938	1.73	1.97	1 5/16

Note: All measurements are in inches.

Female branch tee

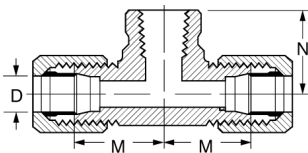
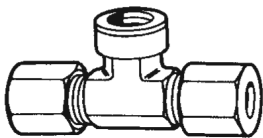

Part no. 7655x (Ref. SAE No. 080427)

Part number	Tube O.D.	Female pipe thread	D	M	N	Across flats
7655x4	1/4	1/8	0.203	0.89	0.66	9/16
7655x4x4x4	1/4	1/4	0.203	1.03	0.88	3/4
7655x6	3/8	1/4	0.281	1.05	0.88	3/4
7655x8	1/2	3/8	0.422	1.23	1.02	7/8
7655x10	5/8	1/2	0.500	1.42	1.23	1 1/16
7655x12	3/4	3/4	0.656	1.58	1.36	1 5/16
7655x14	7/8	3/4	0.718	1.62	1.42	1 5/16
7655x16	1	1	0.875	1.73	1.62	1 5/8
7655x20	1 1/4	1 1/4	1.093	2.08	1.70	1 7/8

Note: All measurements are in inches.

Bags

PB

Plastic bags



Eaton heavy duty plastic bags for fittings come in sizes 5"x6", 6"x10", and 8"x12". The bags include convenient spaces for labeling.

Catalog number	Description	Qty
5x6PB	Plastic Bag	100
6x10PB	Plastic Bag	100
8x12PB	Plastic Bag	100

Accessories

Protective coils, sleeves

900564 Steel coil spring	K-2
900705 Steel coil sleeve	K-2
900952 Plastic coil spring	K-2
222005 Stainless steel internal support coil	K-2
222022 Internal support coil	K-2
FC425 Nylon abrasive sleeve	K-3
624 Firesleeve	K-3
FF9217 Firesleeve clamp	K-3
FF90754 Guardian sleeve	K-4

Clamps

900729 Support clamp	K-5
FF90311 Heavy duty support clamp	K-5

Hose protectors

HP4 Hose protector	K-6
HP6 Hose protector	K-6
HP8 Hose protector	K-6
HPM Hose protector	K-6
FF90308 Hose Insertion gage	K-6
HSM-48 Hose spacer	K-6
HSM-48 Hose spacers	K-6
HLM-48 Hose looms	K-6
Flaretite seals	K-7

Accessories to hose chart **K-8**

K



Accessories

Protective coils, sleeves

K

900564 Steel protective coil spring

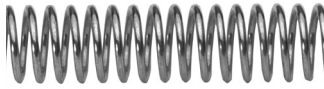

Protects hose cover and reinforcement from abrasion and accidental damage.

Construction: steel wire, rust resistant.

This coil should fit snugly to the hose O.D. expanding the coil I.D. (unwind the coil) may be necessary for proper installation.

For use with hose: see pages K-8-K-14

Sleeve dash number	Sleeve I.D.	
	mm	in.
-1S	15,5	0.61
-12S	17,0	0.67
-2S	19,0	0.75
-15S	20,6	0.81
-14S	21,6	0.85
-3S	23,1	0.91
-4S	26,4	1.04
-5S	30,0	1.18
-6S	34,0	1.34
-7S	42,2	1.66
-9S	47,5	1.87
-8S	54,1	2.13
-10S	60,4	2.38
-13S	69,8	2.75
-11S	73,1	2.88

900705 Steel protective coil sleeve



Recommended for use where hose lines are subjected to excessive abrasion, kinking or accidental damage.

Construction: spring steel, rust resistant.

This coil should fit snugly to the hose O.D. expanding the coil I.D. (unwind the coil) may be necessary for proper installation.

For use with hose: see pages K-8-K-14

Sleeve dash number	Sleeve I.D.	
	mm	in.
-17S	11,2	0.44
-1S	12,7	0.50
-13S	14,5	0.57
-2S	16,0	0.63
-3S	19,0	0.75
-4S	22,3	0.88
-5S	26,2	1.03
-14S	28,7	1.13
-6S	31,0	1.22
-7S	37,3	1.47
-9S	42,9	1.69
-8S	48,5	1.91
-10S	54,1	2.13
-16S	62,0	2.44
-11S	65,0	2.56

900952 Plastic protective coil spring

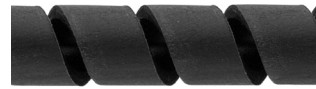

Recommended to protect hose from abrasion, this light weight plastic sleeve is unaffected by air, water, oil, gasoline, hydraulic and most other fluids. This coil can also be used for group bundling of hose lines.

Temperature range of 0°F to +180°F.

For use with hose: see pages K-8-K-14

Part number	Sleeve I.D.	
	mm	in.
900952-30	40,0	1.58
900952-22	34,0	1.34
900952-16	27,0	1.06
900952-12	21,0	0.83
900952-10	16,0	0.63
900952-8	12,5	0.49
900952-6	9,5	0.37
900952-4	6,0	0.24

222005*, 222022 Stainless steel internal support coils



Recommended for vacuum service with most hose.

For use with hose: see pages K-8-K-14

Part number O.D.	Coil	
	mm	in.
222005-23C	8,6	0.34
222005-10C	10,7	0.42
222005-21C	12,9	0.51
222005-11C	15,2	0.60
222022-12C	17,8	0.70
222005-13C	18,5	0.73
222005-14C	23,9	0.94
222022-16C	24,6	0.97
222005-15C	30,2	1.19
222022-20C	31,7	1.25
222005-17C	36,6	1.44
222022-24C	38,1	1.50
222005-18C	47,7	1.88
222022-32C	50,0	1.97
222005-19C	62,0	2.44
222022-40C	67,8	2.67
222022-48C	83,0	3.27
222022-60C	108,7	4.28
222022-80C	134,1	5.28

*222005 is 301 stainless steel.

FC425 Nylon abrasion sleeve

Meets MSHA requirements

Nylon sleeve protects hose from abrasion and allows bundling of hose lines.



For use with hose: see pages K-8-K-14

Part number	Nominal Sleeve I.D.* "B"	
	mm	in.
FC425-12	18,0	0.71
FC425-16	25,4	1.00
FC425-18	28,7	1.13
FC425-20	31,7	1.25
FC425-24	40,4	1.59
FC425-28	44,4	1.75
FC425-32	52,6	2.07
FC425-38	60,4	2.38
FC425-40	64,5	2.54
FC425-46	72,6	2.86
FC425-54	84,8	3.34
FC425-59	93,0	3.66

* The maximum O.D. of hose fittings must be allowed for if fittings are to be covered.

624 Firesleeve

Firesleeve will protect hose from direct flame. Firesleeve is constructed of a uniform single layer of braided fiberglass tubing impregnated with flame resistant silicone rubber. Temperature range of -65°F to +500°F.



For use with hose: see pages K-8-K-14

Part number	I.D.		Clamp # (2 required)
	mm	in.	
624-5	7,9	0.31	FF9217-0622S
624-7	11,2	0.44	FF9217-0622S
624-8	12,7	0.50	FF9217-0622S
624-9	14,2	0.56	FF9217-0622S
624-10	15,7	0.62	FF9217-0622S
624-11	17,5	0.69	FF9217-0622S
624-12	19,0	0.75	FF9217-0622S
624-13	20,6	0.81	FF9217-0622S
624-14	22,3	0.88	FF9217-0622S
624-16	25,4	1.00	FF9217-0622S
624-18	28,4	1.12	FF9217-0622S
624-20	31,7	1.25	FF9217-0648S
624-22	35,0	1.38	FF9217-0648S
624-24	38,1	1.50	FF9217-0648S
624-26	41,1	1.62	FF9217-0648S
624-28	44,4	1.75	FF9217-0648S
624-30	47,7	1.88	FF9217-0648S
624-32	50,8	2.00	FF9217-0648S
624-38	60,4	2.38	FF9217-0648S
624-42	66,5	2.62	FF9217-0648S
624-46	73,1	2.88	FF9217-0664C
624-50	79,2	3.12	FF9217-0664C
624-54	85,8	3.38	FF9217-0664C
624-60	95,2	3.75	FF9217-0664C

FF9217 Firesleeve clamp



Recommended for attaching 624 Firesleeve to hose lines.

Clamp numbers:

FF9217-0622S, FF9217-0648S; 3/8 inch wide

FF9217-0664C; 1/2 inch wide.

For use with hose: see pages K-8-K-14

Accessories

Protective coils, sleeves

K

FF90754

Guardian sleeve

Eaton's new Guardian Sleeve is designed to provide protection against hydraulic hose failure by containing pressure and fluids that may escape during a hose burst or pinhole leak.

Properties	Specification	Description
Burst pressure	16,000 psi	Capable to contain hose burst up to 16,000 psi
Pin hole leak pressure	4,000 psi	Sustained 4,000 psi pin hole deflection from focused 1mm pin hole
Abrasion cycles	250,000	Holds up to 250,000 abrasion cycles per ISO 6945



Denier: 1260

Melting Point: 215°C/420°F

Material: Polyamide 6, made with pre-dyed yarn

Dim. Stability: Great resistance to sun, atmospheric agents and aging

Toxicity: Non-Toxic

Color: Black

Packing Requirements: Eaton Guardian Sleeve comes in a 300 foot roll with no more than 3 cuts per roll and no piece shorter than 30 feet.

Note: must be ordered by the roll.

General and dimensional information

Part number	Nominal I.D. (in)	A – Flat width (in) +/- 0.125	Weights in lbs per 300 ft Roll	Rolls per box
FF90754-68	0.68	1.290	7.43	8
FF90754-79	0.79	1.400	8.50	7
FF90754-91	0.91	1.590	9.70	6
FF90754-98	0.98	1.590	10.13	6
FF90754-106	1.06	1.825	11.10	5
FF90754-122	1.22	2.076	12.60	4
FF90754-142	1.42	2.390	14.50	4
FF90754-157	1.57	2.650	16.10	3
FF90754-173	1.73	2.910	17.70	3
FF90754-185	1.85	3.100	18.80	3
FF90754-209	2.09	3.470	21.10	2
FF90754-219	2.19	3.630	22.10	2
FF90754-238	2.38	3.925	23.90	2
FF90754-288	2.88	4.714	28.60	2
FF90754-366	3.66	5.938	36.10	1

Guardian sleeve chemical compatibility

Chemical	Compatibility
Gasoline	Very Good
Oil	Very Good
Mineral and vegetable oil	Very Good
Ionic metallic solutions	Very Good
Alcohols	Very Good
Diluted bases	Very Good
Diluted acids *	Good
Benzene	Very Good
Acetone	Very Good
Ether	Very Good
Carbon Tetrachloride	Very Good
Chlorine based solvent	Very Good
Mold, bacteria, moths	Very Good

*Strong and concentrated acids; ie. Hcl or Formic acid may have some corrosive action.

Guardian sleeve selection chart

Suggested sleeve Part number	Sleeve I.D. (in)	Max hose OD that sleeve can accept (in)	Hose size as a ref.
FF90754-68	0.68	0.52	-4
FF90754-79	0.79	0.61	-4
FF90754-91	0.91	0.70	-6
FF90754-98	0.98	0.76	-6
FF90754-106	1.06	0.80	-6
FF90754-122	1.22	0.92	-8
FF90754-142	1.42	1.02	-10
FF90754-157	1.57	1.13	-10
FF90754-173	1.73	1.24	-12
FF90754-185	1.85	1.34	-16
FF90754-209	2.09	1.50	-16
FF90754-219	2.19	1.54	-20
FF90754-238	2.38	1.70	-20
FF90754-288	2.88	2.00	-20
FF90754-366	3.66	2.40	-24

Assembly Instructions

1. Select the correct sleeve part number for the hose.
2. Cut the sleeve 2 inches longer than the cut length of the hose to allow full hose bend radius.
3. The ends of the sleeves must be seared to prevent sleeve from fraying.
4. Slide the sleeve over the hose.
5. Properly assemble the hose ends.
6. Secure the sleeve over hose sockets with a metal banding product.

900729

Support clamp

These lightweight vinyl-coated steel support clamps are designed to support hose where long runs are necessary.

This clamp not only furnishes a cleaner installation, but prevents damage, exposure and chafing.

The lining will withstand high ambient temperatures.

Bolt hole dia: Clamp dash no. -01 thru -8, -18 thru -23 is .406; -9 thru -17, -24 thru -31 is .531.



For use with hose: see pages K-8-K-14

Clamp dash no.	Clamp I.D. Closed	
	mm	in.
-18	6,3	0.25
-19	9,6	0.38
-01	11,2	0.44
-1	12,7	0.50
-2	14,2	0.56
-21	16,0	0.63
-3	17,5	0.69
-4	19,0	0.75
-5	20,6	0.81
-6	23,9	0.94
-23	25,4	1.00
-8	26,9	1.06
-9	28,7	1.13
-27	30,2	1.19
-24	31,7	1.25
-25	33,3	1.31
-10	38,1	1.50
-11	39,6	1.56
-12	44,4	1.75
-28	46,0	1.81
-13	50,8	2.00
-29	52,3	2.06
-14	57,1	2.25
-30	63,5	2.50
-31	66,8	2.63
-15	69,8	2.75
-16	73,1	2.88
-17	90,4	3.56

FF90311

Heavy duty hose support clamps

These heavy duty weld-based clamps are designed to securely hold hose in applications subject to impulsing, flexing and vibrating conditions. The clamps help prevent abrasion and extend hose life through proper routing. Clamps are rated to ambient temperature of +250°F.

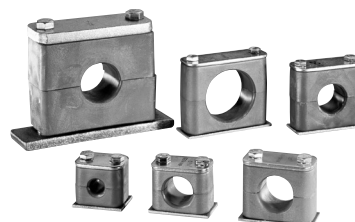

For use with hose: see pages K-8-K-14

Clamp P/N	Inside diameter	
	mm	in.
FF90311-127	12,7	0.50
FF90311-137	13,7	0.54
FF90311-150	15,0	0.59
FF90311-160	16,0	0.63
FF90311-171	17,1	0.67
FF90311-174	17,4	0.69
FF90311-190	19,0	0.75
FF90311-205	20,5	0.81
FF90311-222	22,2	0.87
FF90311-239	23,9	0.94
FF90311-254	25,4	1.00
FF90311-266	26,6	1.05
FF90311-280	28,0	1.10
FF90311-300	30,0	1.18
FF90311-320	32,0	1.26
FF90311-334	33,4	1.31
FF90311-357	35,7	1.41
FF90311-381	38,1	1.50
FF90311-400	40,0	1.57
FF90311-422	42,2	1.66
FF90311-445	44,5	1.75
FF90311-483	48,3	1.90
FF90311-508	50,8	2.00
FF90311-572	57,2	2.25
FF90311-635	63,5	2.50
FF90311-700	70,0	2.76

Accessories

Hose protectors

K

HP4, HP6, HP8 and HPM

Hose protectors

Easy installation in minutes – no need to remove hose, formulated to resist solvents, oils, grease and gasoline.



*Hose protectors available in black, orange or yellow.

Part number	Description
HP4*	4" Hose protector case of 50
HP6*	6" Hose protector case of 50
HP8*	8" Hose protector case of 50
HPM*	Mixed hose protectors case of 60

Features:

- Operating temperature range is -40° to 430°F
- Exceptionally cost effective
- Packed in easy to assemble, colorful, counter display box
- Available in 3 sizes – 4", 6" and 8" – cable ties included

Market applications:

- Farming
- Industrial
- Trucking
- Mining
- Construction
- Aviation support
- Road maintenance
- Waste management
- Original equip. manuf.

HSM-48

Hose spacers



Part number	Description
HSM-48	Case of 48 mixed Hose Spacers

Features:

- Prevents hose abrasion at points of contact
- Helps keep hoses organized
- Prevents damage from unrestrained hoses
- Available in 4 sizes – 3/4", 1", 1-1/8", 1-3/8"
- Packed in colorful counter display boxes of 48 – cable ties included
- Also available in mixed boxes of 48 (12 each size) or refill bags of 12

FF90308

Hose insertion gauge

Improve hose assembly reliability with these easy to use aluminum gages that are designed to ensure proper fitting depth during pre-assembly.

Simply bottom the hose in the appropriately marked cavity and scribe a mark on the hose flush with the top surface of the gauge. Insert the fitting until the back of the socket is aligned with scribe line.



For use with all hoses that mate with TTC, TTC12 and Global Spiral TTC fittings

Part number	Usage
FF90308-01	For use with all hoses that mate with -4 through -16 TTC and TTC12 fittings
FF90308-02	For use with all hoses that mate with -20 through -32 TTC and TTC 12 fittings
FF90308-03	For use with all hoses that mate with -12, -16, -20 spiral TTC fittings
FF90308-04	For use with all hoses that mate with -06, -08, -10, -12, -16 spiral 4S/6S fittings
FF90308-05	For use with all hoses that mate with -20, -24, -32 spiral 4S/6S fittings

HLM-48

Hose looms



Part number	Description
HLM-48	Case of 48 mixed Hose Looms

Features:

- Prevents hose abrasion at points of contact
- Keeps multiple hoses organized
- Simplifies hose routing
- Prevents damage from unrestrained hoses
- Available in 4 sizes – 3/4", 1", 1-1/8", 1-3/8"
- Packed in colorful counter display boxes of 48
- Also available in mixed boxes of 48 (12 each size) or refill bags of 12

Flaretite seals



The ideal product to enhance new installations of SAE 37° connections, as well as seal off minor leaks and weeping connections.

Features

- Ribbed insert design
- Coated with Loctite sealant
- Economical method to reduce minor leaks and weeping connections
- Built-in clip to attach the Flaretite seal to the nose of the SAE 37 degree connection
- Available sizes: -04 through -32

Benefits

- Multiple surface contact points
- Locks the joint and fills surface imperfections
- Saves time & money associated with maintenance and rework
- Quick & easy assembly

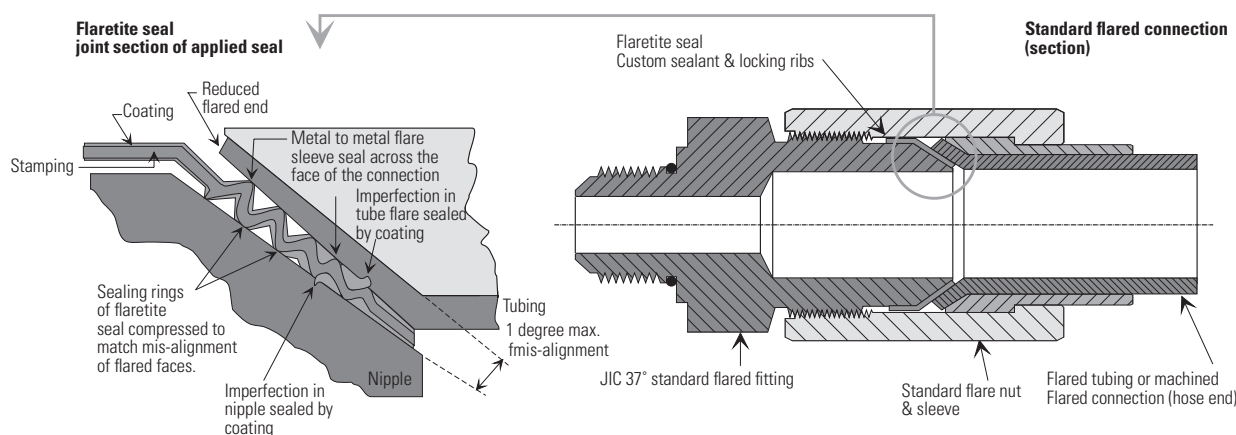

Seal size	Package part number	Number of seals per package
-04	FF13267	100
-06	FF13268	100
-08	FF13269	100
-10	FF13270	100
-12	FF13271	100
-16	FF13272	50
-20	FF13273	50
-24	FF13570	25
-32	FF13571	10

Assembly and torque requirements

To assemble an SAE 37° connection using a Flaretite seal, simply push the Flaretite seal onto the male portion of the connection. The built-in clip will hold the Flaretite seal onto the male half.

During assembly ensure:

- The seal is fitted squarely to the conical nose of the JIC fitting -37° flare.
- The sealing faces of the flared connector part are clean and free of burrs.
- The flared joint is correctly tightened with recommended torque settings noted below.

Recommended torque settings:

Tolerance: +10% -0%

-04 (1/4")	SAE 37°: 14lb-ft.	-10 (5/8")	SAE 37°: 80lb-ft.	-20 (1-1/4")	SAE 37°: 190lb-ft.
-06 (3/8")	SAE 37°: 26lb-ft.	-12 (3/4")	SAE 37°: 110lb-ft.	-24 (1-1/2")	SAE 37°: 220lb-ft.
-08 (1/2")	SAE 37°: 55lb-ft.	-16 (1")	SAE 37°: 140lb-ft.	-32 (2")	SAE 37°: 325lb-ft.











* Flaretite is a registered trademark of Flaretite Inc.
 All photos and the name Flaretite are the property of Flaretite Inc.
 ** Loctite is a registered trademark of the Henkel Corporation.

Accessories











Accessories to hose chart

K

Accessories to hose chart

Hose part #	Steel protective coil spring* 900564	Steel protective coil sleeve* 900705	Plastic coil sleeve 900952	Internal support coil 222005, 222022	Support clamp 900729	Heavy duty support clamp FF90311	Nylon sleeve* FC425	Firesleeve* 624	Firesleeve clamp FF9217	Guardian sleeve FF90754
										
	dash size	dash size	dash size		dash size	dash size	dash size	dash size	dash size	dash size
1503-4	-1S	-1S	-6	-	-1	-137	-12	-11	-0622S	68
1503-5	-12S	-13S	-8	-	-2		-12	-12	-0622S	79
1503-6	-2S	-2S	-10	-	-21	-174	-16	-14	-0622S	91
1503-8	-14S	-3S	-12	222005-10C	-4	-190	-16	-16	-0622S	106
1503-10	-4S	-4S	-12	222005-21C	-6	-239	-20	-18	-0630S	122
1503-12	-5S	-5S	-16	222005-13C	-8	-280	-20	-20	-0630S	157
1503-16	-6S	-6S	-16	222005-14C	-27	-320	-24	-24	-0648S	173
1503-20	-7S	-7S	-22	222005-15C	-10	-381	-28	-30	-0648S	209
1503-24	-9S	-9S	-22	222005-17C	-12	-445	-32	-32	-0648S	238
1503-32	-10S	-10S	-30	222005-18C	-14	-572	-38	-38	-0648S	366
1503-40	-	-12S	-	222005-19C	-16	-	-	-	-	-
1531-10	-4S	-4S	-12	-	-6	-239	-20	-16	-0622S	142
1531-12	-5S	-5S	-16	-	-8	-280	-20	-20	-0630S	173
1531-16	-7S	-6S	-16	-	-25	-357	-24	-24	-0630S	209
1531-20	-7S	-7S	-22	-	-10	-422	-28	-30	-0648S	238
2550-6	-14S	-3S	-10	-	-4	-174	-16	-13	-0622S	98
2554-6	-14S	-2S	-10	-	-4	-174	-16	-13	-0622S	98
2556-10	-4S	-4S	-12	-	-5	-222	-16	-16	-0622S	122
2556-12	-5S	-5S	-16	-	-23	-266	-20	-18	-0630S	157
2556-4	-1S	-1S	-6	-	-1	-127	-12	-9	-0622S	68
2556-6	-12S	-13S	-8	-	-21	-160	-16	-11	-0622S	91
2556-8	-14S	-3S	-10	-	-4	-190	-16	-13	-0622S	98
2565-10	-4S	-4S	-12	-	-6	-239	-16	-16	-0622S	142
2565-12	-5S	-5S	-16	-	-8	-280	-20	-18	-0630S	157
2565-4	-1S	-1S	-6	-	-1	-127	-12	-9	-0622S	68
2565-6	-12S	-13S	-8	-	-21	-160	-16	-11	-0622S	91
2565-8	-14S	-3S	-10	-	-4	-205	-16	-13	-0622S	106
2570-10	-5S	-5S	-16	222005-13C	-8	-239	-20	-20	-0648S	157
2570-6	-14S	-3S	-10	-	-4	-174	-16	-13	-0622S	98
2570-8	-4S	-4S	-12	222005-11C	-6	-190	-16	-18	-0622S	122
2580-10	-4S	-4S	-12	222005-21C	-6	-239	-20	-18	-0630S	122
2580-12	-5S	-5S	-16	222005-13C	-8	-280	-20	-20	-0630S	157
2580-16	-6S	-6S	-16	222005-14C	-27	-320	-24	-24	-0648S	173
2580-20	-7S	-7S	-22	222005-15C	-10	-381	-28	-28	-0648S	209
2580-24	-9S	-9S	-22	222005-17C	-12	-445	-32	-32	-0648S	288
2580-32	-10S	-10S	-30	222005-18C	-14	-572	-40	-42	-0648S	366
2580-4	-1S	-1S	-6	-	-1	-127	-12	-11	-0622S	68
2580-6	-2S	-2S	-10	-	-21	-174	-16	-14	-0622S	91
2580-8	-14S	-3S	-12	222005-10C	-4	-190	-16	-16	-0622S	106

*Sizes indicated are based on Hose O.D. only. If sleeve is to be placed over fittings, a larger sleeve size may be required, depending on type of fitting used.











Hose part #	Steel protective coil spring* 900564	Steel protective coil sleeve* 900705	Plastic coil sleeve 900952	Internal support coil 222005, 222022	Support clamp 900729	Heavy duty support clamp FF90311	Nylon sleeve* FC425	Firesleeve* 624	Firesleeve clamp FF9217	Guardian sleeve FF90754
										
	dash size	dash size	dash size		dash size	dash size	dash size	dash size	dash size	dash size
2583-12	-6S	-14S	-16	-	-24	-320	-24	-24	-0648S	173
2583-16	-7S	-7S	-22	-	-10	-381	-28	-28	-0648S	209
2583-20	-8S	-9S	-22	-	-12	-445	-32	-32	-0648S	288
2583-4	-1S	-1S	-8	-	-2	-150	-12	-11	-0622S	79
2583-6	-14S	-3S	-10	-	-4	-190	-16	-16	-0622S	98
2583-8	-4S	-4S	-12	-	-6	-239	-20	-20	-0648S	142
2651-10	-4S	-4S	-12	222005-21C	-6	-239	-20	-18	-0630S	122
2651-12	-5S	-5S	-16	222005-13C	-8	-280	-20	-20	-0630S	157
2651-16	-6S	-6S	-16	222005-14C	-27	-320	-24	-24	-0648S	173
2651-20	-7S	-7S	-22	222005-15C	-10	-381	-28	-30	-0648S	209
2651-24	-9S	-9S	-22	222005-17C	-12	-445	-32	-32	-0648S	238
2651-32	-10S	-10S	-30	222005-18C	-14	-572	-38	-42	-0648S	366
2651-4	-1S	-1S	-6	-	-1	-137	-12	-11	-0622S	68
2651-40	-	-12S	-	222005-19C	-16	-	-54	-50	-0664C	-
2651-5	-12S	-13S	-8	-	-2	-	-12	-12	-0622S	79
2651-6	-2S	-2S	-10	-	-21	-174	-16	-14	-0622S	91
2651-8	-14S	-3S	-12	222005-10C	-4	-190	-16	-16	-0622S	106
2661-48	-	-	-	-	-	-	-59	-60	-0664C	-
2661-64	-	-	-	-	-	-	-	-	-	-
2681-3	-1S	-1S	-6	-	-1	-	-12	-11	-0622S	68
2681-4	-12S	-13S	-8	-	-21	-160	-16	-12	-0622S	68
2681-5	-2S	-2S	-8	-	-3	-	-16	-14	-0630S	91
2681-6	-14S	-3S	-10	-	-4	-205	-16	-18	-0630S	106
2681-8	-4S	-4S	-12	-	-5	-222	-20	-20	-0630S	122
2681-10	-5S	-5S	-12	-	-23	-266	-20	-20	-0630S	157
2681-12	-6S	-14S	-16	222005-14C	-27	-300	-24	-22	-0648S	173
2681-16	-7S	-7S	-22	222005-15C	-10	-381	-28	-28	-0648S	209
2681-20	-8S	-9S	-22	222005-17C	-28	-445	-32	-38	-0648S	288
2681-24	-10S	-15S	-30	222005-18C	-29	-508	-38	-38	-0648S	288
2681-32	-13S	-11S	-30	222005-19C	-31	-635	-46	-46	-0664C	-
2781-4	-2S	-2S	-8	-	-3	-174	-16	-14	-0622S	91
2781-6	-3S	-3S	-12	-	-5	-222	-16	-16	-0630S	122
2781-8	-4S	-4S	-12	-	-6	-239	-20	-18	-0630S	142
2781-10	-5S	-5S	-16	-	-8	-280	-20	-20	-0630S	157
2781-12	-6S	-6S	-16	-	-24	-320	-24	-26	-0648S	185
2781-16	-7S	-7S	-22	-	-11	-400	-28	-30	-0648S	238
2781-20	-8S	-8S	-30	-	-13	-508	-38	-38	-0648S	288
2781-24	-10S	-10S	-30	-	-14	-572	-40	-42	-0648S	366
2781-32	-11S	-11S	-30	-	-15	-700	-54	-46	-0664C	-
2807-5	-	-	-4	-	-19	-	-	-9	-0622S	68
2807-6	-	-17S	-6	222005-23C	-1	-	-	-10	-0622S	68

*Sizes indicated are based on Hose O.D. only. If sleeve is to be placed over fittings, a larger sleeve size may be required, depending on type of fitting used.











Accessories

Accessories to hose chart

K

Hose part #	Steel protective coil spring* 900564	Steel protective coil sleeve* 900705	Plastic coil sleeve 900952	Internal support coil 222005, 222022	Support clamp 900729	Heavy duty support clamp FF90311	Nylon sleeve* FC425	Firesleeve* 624	Firesleeve clamp FF9217	Guardian sleeve FF90754
										
	dash size	dash size	dash size		dash size	dash size	dash size	dash size	dash size	dash size
2807-8	-1S	-1S	-8	222005-10C	-1	-137	-12	-12	-0622S	79
2807-10	-2S	-3S	-8	222005-21C	-21	-160	-16	-14	-0630S	91
2807-12	-2S	-3S	-10	222005-13C	-4	-190	-16	-16	-0630S	98
2807-16	-3S	-5S	-12	222005-14C	-23	-266	-20	-20	-0630S	157
2807-20	-5S	-6S	-16	222005-15C	-24	-320	-24	-24	-0648S	185
2808-8	-12S	-1S	-6	222005-10C	-2	-150	-12	-16	-0622S	79
2808-10	-2S	-2S	-8	222005-21C	-3	-174	-16	-18	-0630S	91
2808-12	-14S	-3S	-10	222005-13C	-5	-205	-16	-20	-0630S	122
2808-16	-5S	-5S	-16	222005-14C	-8	-280	-20	-26	-0648S	157
2808-20	-7S	-6S	-16	222005-15C	-25	-334	-24	-32	-0648S	209
2808-24	-7S	-7S	-22	222005-17C	-11	-422	-28	-38	-0648S	238
CR170-4	-1S	-1S	-6	-	-1	-	-12	-11	-0622S	68
CR170-6	-2S	-2S	-10	-	-21	-	-16	-14	-0622S	91
CR170-8	-14S	-3S	-12	222005-10C	-4	-	-16	-16	-0622S	106
EC115-4	-1S	-1S	-6	-	-1	-127	-15	-11	-0622S	68
EC115-6	-1S	-13S	-8	-	-2	-150	-16	-12	-0622S	79
EC115-8	-3S	-4S	-12	222005-10C	-4	-190	-18	-12	-0622S	98
EC115-10	-3S	-3S	-12	222005-21C	-5	-205	-24	-16	-0622S	122
EC115-12	-4S	-5S	-16	-	-6	-239	-24	-20	-0630S	142
EC115-16	-5S	-6S	-16	222005-13C	-9	-320	-32	-20	-0630S	173
EC115-20	-7S	-7S	-22	222005-14C	-11	-400	-38	-30	-0648S	238
EC115-24	-8S	-10S	-30	222005-17C	-12	-483	-40	-32	-0664C	288
EC115-32	-13S	-12S	-30	222005-19C	-30	-635	-54	-46	-0664C	366
EC215-4	-1S	-1S	-6	-	-1	-127	-12	-11	-0622S	68
EC215-6	-2S	-2S	-10	-	-3	-174	-16	-14	-0622S	91
EC215-8	-15S	-3S	-10	-	-5	-205	-16	-16	-0622S	122
EC215-10	-4S	-4S	-12	222005-21C	-6	-239	-20	-18	-0630S	122
EC215-12	-4S	-4S	-12	-	-6	-	-20	-18	-0633S	157
EC215-16	-7S	-6S	-16	-	-25	-357	-24	-24	-0630S	209
EC215-20	-7S	-9S	-22	-	-12	-422	-28	-28	-0648S	288
EC215-24	-8S	-8S	-30	-	-13	-508	-38	-38	-0648S	288
EC215-32	-13S	-12S	-30	-	-30	-635	-46	-46	-0664C	-
EC415-6	-3S	-3S	-12	-	-5	-	-18	-18	-0622S	122
EC415-8	-4S	-4S	-12	-	-6	-239	-20	-18	-0630S	122
EC415-10	-4S	-4S	-12	-	-6	-	-20	-18	-0633S	157
EC415-12	-6S	-14S	-16	-	-27	-300	-24	-22	-0648S	173
EC415-16	-7S	-7S	-22	-	-10	-381	-28	-30	-0648S	209
EC415-20	-8S	-9S	-22	-	-28	-445	-32	-38	-0648S	288
EC415-24	-10S	-10S	-30	-	-13	-	-38	-38	-0648S	366
EC415-32	-10S	-11S	-30	-	-31	-700	-54	-46	-0664C	-
EC420-12	-6S	-6S	-16	-	-24	-320	-24	-26	-0648S	185

*Sizes indicated are based on Hose O.D. only. If sleeve is to be placed over fittings, a larger sleeve size may be required, depending on type of fitting used.











Hose part #	Steel protective coil spring* 900564	Steel protective coil sleeve* 900705	Plastic coil sleeve 900952	Internal support coil 222005, 222022	Support clamp 900729	Heavy duty support clamp FF90311	Nylon sleeve* FC425	Firesleeve* 624	Firesleeve clamp FF9217	Guardian sleeve FF90754
										
	dash size	dash size	dash size		dash size	dash size	dash size	dash size	dash size	dash size
EC420-16	-7S	-7S	-22	-	-10	-381	-28	-30	-0648S	209
EC420-20	-8S	-8S	-30	-	-13	-508	-38	-38	-0648S	288
EC420-24	-10S	-10S	-30	-	-14	-572	-38	-38	-0648S	366
EC420-32	-11S	-11S	-30	-	-15	-700	-54	-46	-0664C	-
EC525-12	-6S	-14S	-16	-	-27	-300	-24	-22	-0648S	173
EC525-16	-7S	-7S	-22	-	-10	-381	-28	-30	-0648S	209
EC525-20	-8S	-9S	-22	-	-28	-445	-32	-38	-0648S	288
EC525-24	-10S	-10S	-30	-	-13	-	-38	-38	-0648S	366
EC525-32	-10S	-11S	-30	-	-31	-700	-54	-46	-0664C	-
EC600-12	-6S	-6S	-16	-	-24	-320	-24	-20	-0648S	185
EC600-16	-9S	-7S	-22	-	-10	-381	-32	-26	-0648S	209
EC600-20	-10S	-8S	-30	-	-13	-508	-38	-36	-0648S	288
EC615-16	-7S	-9S	-22	-	-10	-381	-24	-28	-0648S	209
EC615-20	-8S	-8S	-30	-	-13	-508	-38	-38	-0648S	288
EC615-24	-10S	-10S	-30	-	-14	-572	-38	-38	-0648S	366
EC810-12	-6S	-6S	-16	-	-24	-320	-24	-26	-0648S	185
EC810-16	-7S	-7S	-22	-	-10	-381	-28	-28	-0648S	209
EC810-20	-8S	-8S	-30	-	-13	-508	-38	-38	-0648S	288
EC810-24	-10S	-10S	-30	-	-14	-572	-38	-38	-0648S	366
EC810-32	-11S	-11S	-30	-	-15	-700	-54	-46	-0664C	-
FC234-5	-1S	-2S	-10	-	-21	-150	-12	-11	-0622S	68
FC234-6	-2S	-3S	-12	-	-4	-174	-12	-12	-0622S	91
FC234-8	-3S	-4S	-12	222005-10C	-4	-190	-16	-12	-0622S	98
FC234-10	-4S	-5S	-16	222005-21C	-23	-239	-16	-13	-0622S	122
FC234-12	-5S	-14S	-16	222005-13C	-9	-280	-20	-16	-0630S	157
FC234-16	-6S	-7S	-22	222005-14C	-24	-320	-20	-20	-0630S	173
FC254-8	-4S	-4S	-12	-	-6	-254	-20	-18	-0630S	142
FC254-12	-6S	-6S	-16	-	-24	-320	-24	-26	-0648S	173
FC254-16	-7S	-7S	-22	-	-10	-381	-28	-30	-0648S	209
FC254-20	-8S	-9S	-22	-	-28	-445	-32	-32	-0648S	288
FC254-24	-10S	-10S	-30	-	-29	-	-38	-38	-0648S	366
FC254-32	-10S	-11S	-30	-	-31	-700	-54	-46	-0664C	-
FC273B-12	-6S	-14S	-16	-	-27	-300	-24	-22	-0648S	173
FC273B-16	-7S	-7S	-22	-	-10	-381	-28	-30	-0648S	209
FC273B-20	-8S	-8S	-30	-	-13	-508	-38	-38	-0648S	288
FC273B-24	-10S	-10S	-30	-	-14	-572	-38	-38	-0648S	366
FC273B-32	-11S	-11S	-30	-	-15	-700	-54	-46	-0664C	-
FC300-4	-1S	-1S	-6	-	-1	-137	-12	-11	-0622S	79
FC300-5	-12S	-13S	-8	-	-2	-	-12	-12	-0622S	79
FC300-6	-2S	-2S	-10	-	-21	-174	-16	-14	-0622S	91
FC300-8	-14S	-3S	-12	222005-10C	-4	-190	-16	-16	-0622S	98

*Sizes indicated are based on Hose O.D. only. If sleeve is to be placed over fittings, a larger sleeve size may be required, depending on type of fitting used.











Accessories

Accessories to hose chart

K

Hose part #	Steel protective coil spring* 900564	Steel protective coil sleeve* 900705	Plastic coil sleeve 900952	Internal support coil 222005, 222022	Support clamp 900729	Heavy duty support clamp FF90311	Nylon sleeve* FC425	Firesleeve* 624	Firesleeve clamp FF9217	Guardian sleeve FF90754
										
	dash size	dash size	dash size		dash size	dash size	dash size	dash size	dash size	dash size
FC300-10	-4S	-4S	-12	222005-21C	-6	-239	-20	-18	-0630S	142
FC300-12	-5S	-5S	-16	222005-13C	-8	-280	-20	-20	-0630S	157
FC300-16	-6S	-6S	-16	222005-14C	-27	-320	-24	-24	-0648S	185
FC300-20	-7S	-7S	-22	222005-15C	-10	-381	-28	-30	-0648S	209
FC300-24	-9S	-9S	-22	222005-17C	-12	-445	-32	-32	-0648S	238
FC300-32	-10S	-10S	-30	222005-18C	-14	-572	-38	-38	-0648S	366
FC300-40	-	-12S	-	222005-19C	-16	-	-	-	-	-
FC310/ FC510-4	-12S	-1S	-6	-	-2	-137	-12	-12	-0622S	79
FC310/ FC510-6	-14S	-2S	-10	-	-4	-174	-12	-16	-0622S	91
FC310/ FC510-8	-3S	-3S	-12	-	-5	-205	-16	-16	-0630S	106
FC310/ FC510-10	-5S	-4S	-12	-	-6	-239	-20	-18	-0630S	142
FC310/ FC510-12	-6S	-5S	-16	-	-8	-280	-24	-20	-0630S	157
FC310/ FC510-16	-9S	-6S	-16	-	-25	-357	-28	-24	-0648S	209
FC310/ FC510-20	-9S	-8S	-30	-	-12	-422	-32	-30	-0648S	238
FC321-4	-1S	-1S	-6	-	-1	-137	-12	-11	-0622S	79
FC321-5	-12S	-13S	-8	-	-2	-150	-12	-12	-0622S	79
FC321-6	-2S	-2S	-10	-	-21	-174	-16	-14	-0622S	91
FC321-8	-14S	-3S	-12	222005-10C	-4	-190	-16	-16	-0622S	122
FC321-10	-4S	-4S	-12	222005-11C	-5	-239	-20	-18	-0630S	122
FC321-12	-5S	-5S	-16	222005-13C	-8	-280	-20	-20	-0630S	157
FC321-16	-6S	-6S	-16	222005-14C	-27	-320	-24	-22	-0630S	173
FC332-4	-1S	-1S	-6	-	-	-127	-12	-9	-0622S	68
FC332-6	-12S	-13S	-8	-	-21	-160	-16	-11	-0622S	91
FC332-8	-14S	-3S	-10	-	-4	-190	-16	-13	-0622S	98
FC332-10	-3S	-4S	-12	-	-5	-222	-20	-16	-0622S	122
FC332-12	-5S	-5S	-12	-	-23	-266	-20	-18	-0630S	157
FC350-4	-1S	-1S	-6	-	-1	-127	-12	-11	-0622S	79
FC350-5	-12S	-13S	-8	-	-2	-150	-12	-12	-0622S	79
FC350-6	-2S	-2S	-10	-	-21	-174	-16	-14	-0622S	91
FC350-8	-14S	-3S	-12	222005-10C	-4	-190	-16	-16	-0622S	106
FC350-10	-4S	-4S	-12	222005-21C	-6	-239	-20	-18	-0630S	142
FC350-12	-5S	-5S	-5	222005-13C	-8	-280	-20	-20	-0630S	157
FC350-16	-6S	-6S	-16	222005-14C	-27	-320	-24	-24	-0648S	173
FC350-20	-7S	-7S	-22	222005-15C	-10	-381	-28	-30	-0648S	209
FC350-24	-9S	-9S	-22	222005-17C	-12	-445	-32	-32	-0648S	288
FC355-4	-1S	-1S	-6	-	-1	-127	-12	-11	-0622S	79
FC355-5	-1S	-2S	-6	-	-1	-150	-12	-11	-0622S	91

*Sizes indicated are based on Hose O.D. only. If sleeve is to be placed over fittings, a larger sleeve size may be required, depending on type of fitting used.











Hose part #	Steel protective coil spring* 900564	Steel protective coil sleeve* 900705	Plastic coil sleeve 900952	Internal support coil 222005, 222022	Support clamp 900729	Heavy duty support clamp FF90311	Nylon sleeve* FC425	Firesleeve* 624	Firesleeve clamp FF9217	Guardian sleeve FF90754
										
	dash size	dash size	dash size		dash size	dash size	dash size	dash size	dash size	dash size
FC355-6	-12S	-1S	-8	-	-2	-174	-12	-12	-0622S	91
FC355-8	-2S	-13S	-10	-	-3	-190	-16	-12	-0622S	106
FC355-10	-3S	-3S	-12	222005-10C	-5	-239	-16	-13	-0622S	142
FC355-12	-4S	-5S,-4S	-6	222005-21C	-6	-280	-20	-16	-0630S	157
FC355-16	-5S	-6S	-16	222005-13C	-9	-320	-20	-20	-0630S	173
FC355-20	-6S	-7S	-22	222005-14C	-24	-381	-24	-22	-0648S	219
FC355-24	-7S	-7S	-22	222005-15C	-10	-445	-28	-30	-0648S	288
FC355-32	-9S	-9S	-22	222005-17C	-12	-572	-32	-32	-0648S	366
FC466-4	-1S	-1S	-6	-	-1	-127	-12	-9	-0622S	68
FC466-6	-12S	-13S	-8	-	-21	-160	-16	-11	-0622S	91
FC466-8	-14S	-3S	-10	-	-4	-190	-16	-13	-0622S	98
FC466-10	-3S	-4S	-12	-	-5	-222	-20	-16	-0622S	122
FC498/ FC598-4	-1S	-1S	-6	-	-	-127	-12	-9	-0622S	68
FC498/ FC598-6	-12S	-13S	-8	-	-21	-160	-16	-11	-0622S	91
FC498/ FC598-8	-14S	-3S	-10	-	-4	-190	-16	-13	-0622S	98
FC498/ FC598-10	-3S	-4S	-12	-	-5	-222	-20	-16	-0622S	122
FC498/ FC598-12	-5S	-5S	-12	-	-23	-266	-20	-18	-0630S	157
FC500-12	-7S	-14S	-16	-	-27	-300	-24	-22	-0648S	173
FC500-16	-9S	-7S	-22	-	-10	-381	-32	-26	-0648S	209
FC500-20	-10S	-8S	-22	-	-28	-	-38	-32	-0648S	288
FC500-24	-10S	-10S	-30	-	-13	-	-40	-36	-0648S	366
FC500-32	-8S	-11S	-30	-	-15	-700	-54	-48	-0664C	-
FC639-6	-2S	-2S	-10	-	-3	-174	-16	-14	-0622S	91
FC639-8	-15S	-3S	-10	-	-5	-205	-16	-16	-0622S	122
FC639-10	-4S	-5S	-16	-	-6	-239	-20	-20	-0630S	142
FC639-12	-5S	-6S	-16	222005-14C	-9	-280	-22	-22	-0648S	173
FC639-16	-7S	-7S	-22	222005-15C	-10	-357	-24	-28	-0648S	209
FC647-4	-1S	-1S	-6	-	-1	-127	-12	-9	-0622S	68
FC647-6	-12S	-13S	-8	-	-21	-160	-16	-11	-0622S	91
FC647-8	-14S	-3S	-10	-	-4	-190	-16	-13	-0622S	106
FC647-10	-3S	-4S	-12	-	-5	-222	-20	-16	-0622S	122
FC647-12	-5S	-5S	-12	-	-23	-266	-20	-18	-0630S	157
FC650-6	-2S	-2S	-10	-	-21	-160	-16	-14	-0622S	91
FC650-8	-14S	-3S	-12	222005-10C	-4	-190	-16	-16	-0622S	98
FC650-10	-3S	-3S	-12	-	-5	-205	-16	-16	-0622S	122
FC650-12	-4S	-5S	-16	-	-6	-254	-20	-20	-0630S	142
FC650-4	-1S	-1S	-6	-	-1	-	-12	-11	-0622S	68
FC693-4	-1S	-13S	-8	-	-2	-	-12	-12	0622S	79

*Sizes indicated are based on Hose O.D. only. If sleeve is to be placed over fittings, a larger sleeve size may be required, depending on type of fitting used.











Accessories

Accessories to hose chart

K

Hose part #	Steel protective coil spring* 900564	Steel protective coil sleeve* 900705	Plastic coil sleeve 900952	Internal support coil 222005, 222022	Support clamp 900729	Heavy duty support clamp FF90311	Nylon sleeve* FC425	Firesleeve* 624	Firesleeve clamp FF9217	Guardian sleeve FF90754
										
	dash size	dash size	dash size		dash size	dash size	dash size	dash size	dash size	dash size
FC693-6	-1S	-2S	-10	-	-4	-	-16	-16	-0622S	98
FC693-8	-3S	-3S	-12	-	-5	-	-18	-18	-0622S	122
FC699-4	-12S	-1S	-6	-	-2	-	-12	-12	-0622S	68
FC699-6	-14S	-2S	-10	-	-4	-174	-16	-16	-0622S	91
FC699-8	-3S	-3S	-12	-	-5	-205	-16	-16	-0630S	106
FC699-10	-4S	-4S	-12	-	-6	-239	-20	-18	-0630S	142
FC699-12	-5S	-5S	-16	-	-8	-280	-20	-22	-0630S	157
FC735-4	-1S	-1S	-6	-	-1	-127	-12	-11	-0622S	68
FC735-6	-2S	-2S	-10	-	-3	-171	-16	-16	-0622S	91
FC735-8	-15S	-3S	-10	-	-5	-205	-16	-16	-0622S	122
FC735-10	-4S	-4S	-12	-	-6	-254	-20	-18	-0630S	142
FC735-12	-5S	-14S	-16	-	-9	-280	-24	-22	-0648S	173
FC735-16	-7S	-7S	-22	222005-15C	-10	-357	-24	-28	-0648S	185
FC735-20	-7S	-9S	-22	-	-12	-422	-28	-28	-0648S	288
FC736-6	-3S	-3S	-12	-	-5	-205	-16	-16	-0630S	122
FC736-8	-4S	-4S	-12	-	-6	-239	-20	-18	-0630S	142
FC736-10	-5S	-5S	-16	-	-8	-280	-20	-20	-0630S	157
FC736-12	-6S	-6S	-16	-	-24	-300	-24	-26	-0630S	209
FC736-16	-7S	-7S	-22	-	-11	-381	-28	-28	-0630S	288
FC736-20	-8S	-8S	-22	-	-28	-	-32	-30	-0648S	288
FC839B-4	-1S	-1S	-6	-	-1	-127	-12	-11	-0622S	68
FC839B-6	-12S	-2S	-10	-	-21	-160	-16	-14	-0622S	91
FC839B-8	-14S	-3S	-12	-	-5	-205	-16	-18	-0622S	122
FC839B-10	-4S	-5S	-16	-	-6	-239	-20	-20	-0630S	142
FC839B-12	-5S	-6S	-16	-	-9	-280	-22	-22	-0648S	173
FC839B-16	-7S	-7S	-22	-	-10	-381	-28	-30	-0648S	209
GH100-10	-3S	-4S	-12	-	-5	-222	-20	-16	-0622S	122
GH100-12	-5S	-5S	-12	-	-23	-266	-20	-18	-0630S	157
GH100-4	-1S	-1S	-6	-	-	-127	-12	-9	-0622S	79
GH100-6	-12S	-13S	-8	-	-21	-160	-16	-11	-0622S	98
GH100-8	-14S	-3S	-10	-	-4	-190	-16	-13	-0622S	98
GH120-4	-1S	-13S	-8	-	-2	-137	-12	-12	-0622S	79
GH120-6	-2S	-2S	-10	-	-3	-171	-16	-16	-0622S	91
GH120-8	-14S	-3S	-12	-	-5	-205	-16	-18	-0622S	122
GH120-10	-4S	-5S	-16	-	-6	-239	-20	-20	-0630S	142
GH120-12	-5S	-6S	-16	-	-9	-280	-22	-22	-0648S	173
GH120-16	-7S	-7S	-22	-	-10	-357	-24	-28	-0648S	209
GH120-20	-9S	-8S	-30	-	-	-422	-32	-30	-0648S	288
GH120-24	-10S	-15S	-30	-	-29	-508	-38	-38	-0648S	288
GH120-32	-13S	-12S	-30	-	-30	-635	-46	-46	-0664C	-
GH194-4	-1S	-1S	-6	-	-1	-137	-12	-11	-0622S	79

*Sizes indicated are based on Hose O.D. only. If sleeve is to be placed over fittings, a larger sleeve size may be required, depending on type of fitting used.











Hose part #	Steel protective coil spring* 900564	Steel protective coil sleeve* 900705	Plastic coil sleeve 900952	Internal support coil 222005, 222022	Support clamp 900729	Heavy duty support clamp FF90311	Nylon sleeve* FC425	Firesleeve* 624	Firesleeve clamp FF9217	Guardian sleeve FF90754
										
	dash size	dash size	dash size		dash size	dash size	dash size	dash size	dash size	dash size
GH194-6	-2S	-2S	-10	-	-3	-174	-16	-14	-0622S	91
GH194-8	-15S	-3S	-10	-	-5	-205	-16	-16	-0622S	122
GH194-10	-4S	-4S	-12	-	-6	-239	-20	-18	-0630S	142
GH194-12	-4S	-4S	-12	-	-6	-	-20	-18	-0633S	157
GH194-16	-6S	-6S	-22	-	-25	-357	-24	-26	-0648S	209
GH194-20	-9S	-8S	-30	-	-1	-445	-32	-30	-0648S	288
GH194-24	-8S	-8S	-30	-	-13	-508	-38	-38	-0648S	288
GH194-32	-13S	-12S	-30	-	-30	-635	-46	-46	-0664C	-
GH195-4	-12S	-13S	-8	-	-2	-150	-15	-11	-0622S	79
GH195-6	-14S	-2S	-10	-	-4	-190	-16	-13	-0622S	98
GH195-8	-3S	-3S	-12	-	-5	-222	-18	-16	-0622S	122
GH195-10	-6S	-5S	-16	-	-6	-266	-20	-18	-0630S	142
GH195-12	-7S	-6S	-16	-	-9	-300	-24	-20	-0648S	173
GH195-16	-9S	-9S	-22	-	-10	-381	-32	-26	-0648S	209
GH195-20	-10S	-10S	-30	-	-12	-483	-38	-32	-0664C	288
GH195-24	-10S	-11S	-30	-	-13	-	-40	-36	-0648S	366
GH195-32	-11S	-12S	-30	-	-30	-635	-54	-46	-0664C	-
GH466-20	-10S	-8S	-30	-	-13	-508	-38	-36	-0648S	288
GH493-6	-15S	-3S	-12	-	-5	-205	-16	-16	-0622S	106
GH493-8	-3S	-4S	-12	-	-6	-239	-20	-20	-0648S	122
GH493-10	-4S	-5S	-16	-	-8	-280	-20	-22	-0648S	157
GH493-12	-5S	-6S	-16	-	-27	-300	-24	-24	-0648S	173
GH493-16	-7S	-7S	-22	-	-10	-381	-28	-28	-0648S	209
GH493-20	-8S	-10S	-22	-	-28	-	-32	-38	-0648S	288
GH493-24	-8S	-10S	-30	-	-29	-	-38	-38	-0648S	366
GH493-32	-13S	-11S	-30	-	-31	-	-46	-46	-0664S	-
GH506-12	-7S	-6S	-16	-	-24	-320	-24	-50	-0648S	173
GH506-16	-9S	-7S	-22	-	-10	-381	-32	-26	-0648S	209
GH506-20	-10S	-9S	-22	-	-28	-445	-38	-32	-0648S	288
GH663-4	-1S	-1S	-6	-	-1	-137	-12	-11	-0622S	79
GH663-6	-2S	-2S	-10	-	-3	-174	-16	-14	-0622S	91
GH663-8	-15S	-3S	-10	-	-5	-205	-16	-16	-0622S	122
GH663-12	-5S	-5S	-16	-	-8	-280	-24	-22	-0648S	173
GH663-16	-7S	-6S	-22	-	-25	-357	-24	-26	-0648S	209
GH663-20	-9S	-8S	-30	-	-12	-422	-32	-30	-0648S	288
GH663-24	-8S	-8S	-30	-	-13	-483	-38	-38	-0648S	288
GH663-32	-13S	-12S	-30	-	-30	-635	-46	-46	-0664C	-
GH681-3	-1S	-1S	-6	-	-1	-	-12	-11	-0622S	68
GH681-4	-1S	-1S	-6	-	-1	-127	-15	-11	-0622S	68
GH681-5	-1S	-1S	-6	-	-1	-137	-12	-11	-0622S	79
GH681-6	-12S	-2S	-10	-	-21	-160	-16	-14	-0622S	91

*Sizes indicated are based on Hose O.D. only. If sleeve is to be placed over fittings, a larger sleeve size may be required, depending on type of fitting used.

Accessories

Accessories to hose chart

K

Hose part #	Steel protective coil spring* 900564	Steel protective coil sleeve* 900705	Plastic coil sleeve 900952	Internal support coil 222005, 222022	Support clamp 900729	Heavy duty support clamp FF90311	Nylon sleeve* FC425	Firesleeve* 624	Firesleeve clamp FF9217	Guardian sleeve FF90754
										
	dash size	dash size	dash size		dash size	dash size	dash size	dash size	dash size	dash size
GH681-8	-14S	-3S	-12	-	-4	-205	-20	-16	-0622S	98
GH681-10	-3S	-3S	-12	-	-5	-205	-20	-16	-0622S	122
GH681-12	-4S	-5S	-16	-	-6	-254	-24	-20	-0630S	142
GH681-16	-5S	-6S	-16	222005-13C	-9	-320	-32	-20	-0630S	173
GH681-20	-7S	-7S	-22	222005-14C	-11	-400	-38	-30	-0648S	238
GH681-24	-8S	-10S	-30	-	-12	-483	-40	-32	-0664C	288
GH681-32	-13S	-12S	-30	-	-30	-635	-54	-46	-0664C	-
GH781-4	-1S	-13S	-8	-	-2	-137	-15	-12	-0622S	79
GH781-6	-2S	-2S	-10	-	-3	-174	-16	-16	-0622S	91
GH781-8	-14S	-3S	-12	-	-5	-205	-20	-18	-0622S	142
GH781-10	-5S	-5S	-12	-	-6	-239	-20	-18	-0630S	142
GH781-12	-6S	-14S	-16	-	-9	-280	-24	-20	-0648S	173
GH781-16	-9S	-7S	-22	-	-10	-357	-28	-24	-0648S	209
GH781-20	-9S	-9S	-22	-	-12	-422	-32	-30	-0648S	288
GH781-24	-10S	-8S	-30	-	-13	-508	-38	-36	-0648S	288
GH781-32	-11S	-12S	-30	-	-30	-635	-54	-46	-0664C	288
GH793-4	-1S	-13S	-8	-	-2	-150	-12	-12	-0622S	79
GH793-6	-15S	-2S	-10	-	-4	-190	-16	-16	-0622S	98
GH793-8	-3S	-3S	-12	-	-5	-222	-16	-18	-0622S	122
GH793-10	-4S	-5S	-16	-	-6	-266	-20	-20	-0630S	157
GH793-12	-5S	-6S	-16	-	-9	-300	-20	-22	-0648S	173
GH793-16	-7S	-9S	-22	-	-10	-381	-24	-28	-0648S	209
GH793-20	-8S	-10S	-30	-	-12	-483	-32	-32	-0664C	288
GH793-24	-10S	-10S	-30	-	-13	-	-38	-38	-0648S	366
GH793-32	-13S	-12S	-30	-	-30	-635	-46	-46	-0664C	-
H201-4	-1S	-1S	-6	-	-	-127	-12	-9	-0622S	68
H201-6	-12S	-13S	-8	-	-21	-160	-16	-11	-0622S	98
H201-8	-14S	-3S	-10	-	-4	-190	-16	-13	-0622S	68
H201-10	-3S	-4S	-12	-	-5	-222	-20	-16	-0622S	122
H201-12	-5S	-5S	-12	-	-23	-266	-20	-18	-0630S	157

*Sizes indicated are based on Hose O.D. only. If sleeve is to be placed over fittings, a larger sleeve size may be required, depending on type of fitting used.

Assembly equipment

Hose assembly cell setup options

Option 1 Mobile hose assembly cell	L-2
Option 2 Small hose assembly cell	L-2
Option 3 Small to medium hose assembly cell	L-2
Option 4 Medium to large serial production hose assembly cell	L-3
Option 5 Large serial production hose assembly cell	L-3

Hose assembly crimp machines

Variable crimp machines	
ET1187 Portable variable	L-4
FT1380 ProCrimp®	L-5
FT1280	L-6
FT1390 ProCrimp®	L-7
Crimp cages for FT1380	L-8
Crimp cages for FT1390	L-9
Programmable crimp machines	
ET5040 crimp machine	L-10
ET5050 crimp machine	L-11
Dies and kits for ET5040 and ET5050	L-12

Hose preparation

Hose saws and blades	
ET9100 Hose saw	L-14
ET9200 Hose saw	L-15
ET9300 Hose saw	L-15
Hose saw blades	L-16
Skiving tools	L-18

Reusable fitting assembly equipment

FT1097	L-19
FT1013	L-20
FT1028	L-21

Reusable fitting accessories

Hose cutting accessories	L-23
--------------------------	------

Hose proof test stands

FT1312	L-24
FT1261	L-24
FT1058	L-25

Contamination control products

FT1455 projectile cleaning system	L-26
FT1455 Hardware	L-27
FT1455 Kits	L-28
FT1455 Cleaning nozzles	L-29
FT1455 Adapter & locking rings	L-30
FT1455 Accessories	L-31
FT1455 & FT1355 recommendations	
for hoses assemblies	L-32
for pipes and tubes (inch)	L-33
for tubes (metric)	L-34
FT1355 cleaning projectiles	
for hose assemblies	L-35
for tube and pipe assemblies	L-36
Selection ordering guidelines	L-37
FT1555 CapSeal system	L-39
FT1555 Hardware	L-40
FT1555 Kits	L-41
FT1555 Capsules	L-42
FT1555 Accessories	L-42

L



Assembly equipment

Hose assembly cell setup options

This package contains five options for hose assembly cell setup. Any of the equipment listed in the options can be mixed and matched to suit specific needs.

Option 1

Mobile hose assembly cell

This option will allow crimping of 2 wire braided hydraulic hoses ranging in size from -04 to -20, and 4 spiral hydraulic hoses ranging in size from -06 to -16.

Estimated maximum production capability – Up to 40 pcs/hr

Category	Part number	Comments
Hose preparation		
Hose saws	ET9100-07-XX or ET920010-XX	XX depending on power source. 12/24 DC available in ET9200 series
Hose assembly		
Portable crimper Swager Assembly cleaning system	ET1187 Mark IX FT1455-K1	Small hose diameter cleaning kit (1/4" thru 1 1/4" FT1455-L1 launcher, 7 hose nozzles, case, ET1455-QC coupling)
Post assembly		
Capping machine	FT1555-HH-K1	Hand held electric heat gun, case, flex stand, 1 1/2" diffuser

Option 2

Small hose assembly cell

This option will allow crimping of 2 wire braided hydraulic hoses ranging in size from -04 to -32, and 4 spiral hydraulic hoses ranging in size from -06 to -20.

Estimated maximum production capability – Up to 40 pcs/hr

Category	Part number	Comments
Hose preparation		
Hose saws Skiving machine	ET9200-10-XX FT1229-100-XX, FT1230-100-XX, FT1229-2-3, FT1229-3-4, FT1231-100-XX, FT1240-100-XX & FT1240-150-XX	XX depending on power source XX is the hose size
Hose assembly		
Bench top crimper Swager Assembly cleaning system	ET1187 FT1380 Mark IX FT1455-K3	Medium hose diameter cleaning Kit (1/4" thru 2", UC-HL2 launcher, 9 hose nozzles, case, QRC-C coupling, AR-1 adapter ring)
Post assembly		
Proof test table Capping machine	FT1058 FT1555-HH-K1 & FT1555-HH-D20	Up to 2" hoses FT1555-HH-K1 & 2" diffuser for hand held electric heat gun

This package contains five options for hose assembly cell setup. Any of the equipment listed in the options can be mixed and matched to suit specific needs.

Option 3

Small to medium hose assembly cell

This option will allow crimping of 2 wire braided hydraulic hoses ranging in size from -04 to -48, and 4 spiral hydraulic hoses ranging in size from -06 to -32 (including die set for 1W Fittings).

Estimated maximum production capability – Up to 70 pcs/hr (higher possible with multiple operator setup).

Category	Part number	Comments
Hose preparation		
Hose saws Skiving machine	ET9200-07-XX & ET9300-14-XX FT1229-100-XX, FT1230-100-XX, FT1229-2-3, FT1229-3-4, FT1231-100-XX, FT1240-100-XX & FT1240-150-XX	XX depending on power source XX is the hose size
Hose assembly		
Bench top crimper Pre-programmed crimper Swager Assembly cleaning system	FT1380 ET5040 Mark IX ET1455-K5	Large hose diameter cleaning kit (1/4" thru 4 1/2", nozzles, case, brass coupling, 2 adapter rings & locking ring)
Post assembly		
Proof test table Capping machine	FT1312 FT1555-BM	Up to 2" Bench mount production heat shrink machine with timer

This package contains five options for hose assembly cell setup. Any of the equipment listed in the options can be mixed and matched to suit specific needs.

Option 4

Medium to large serial production hose assembly cell

This option will allow crimping of 2 wire braided hydraulic hoses ranging in size from -04 to -48, and 4 Spiral hydraulic hoses ranging in size from -06 to -32 (including die set for 1W Fittings). Add LifeSense® hose preparation capability. Limited industrial and specialty hose crimping capability up to 6".

Estimated maximum production capability - Up to 100 pcs/hr (higher possible with multiple operator setup).

Category	Part number	Comments
Hose preparation Hose saws	ET9200-07-XX & ET9300-14-XX	XX based on voltage. ET9300 can cut only up to 5" industrial hose. Need ET9X00-XX-D diamond blade for big 6 spirals
Skiving machine	FT1229-100-XX, FT1230-100-XX, FT1229-2-3, FT1229-3-4, FT1231-100-XX, FT1240-100-XX & FT1240-150-XX	XX is the hose size
LifeSense® preparation	ET9X00-XX-D ET0100-005	6" x 48" sander with guard and ET0100-001 orbital guide
Hose assembly Bench top crimper Pre-programmed serial production crimper Swager Assembly cleaning system	FT1380/FT1390 ET5040/ET5050 Mark IX ET1455-L4 & ET1455-K5	Small hose diameter bench mount cleaning kit (1/4" thru 1 1/4" bench mount launcher with 7 hose nozzles) & large hose diameter cleaning kit (1/4" thru 4 1/2", nozzles, case, brass coupling, 2 adapter rings & locking ring)
Post assembly Proof test table Capping machine	FT1261 FT1555-BM	Bench mount production heat shrink machine with timer. Produces 50 ft lengths, for hoses up to 2"

This package contains five options for hose assembly cell setup. Any of the equipment listed in the options can be mixed and matched to suit specific needs.

Option 5

Large serial production hose assembly cell

This option will allow crimping of 2 wire braided hydraulic hoses ranging in size from -04 to -48, and 4 Spiral hydraulic hoses ranging in size from -06 to -32 (including die set for 1W Fittings). Adds LifeSense® hose preparation capability. Limited industrial and specialty hose crimping capability up to 10".

Estimated maximum production capability - Up to 100 pcs/hr (higher possible with multiple operator setup).

Category	Part number	Comments
Hose preparation Hose saws	ET9200-07-XX & ET9300-14-XX	XX based on voltage. ET9300 can cut only up to 5" industrial hose. Need ET9X00-XX-D diamond blade for big 6 spirals
Skiving machine	FT1229-100-XX, FT1230-100-XX, FT1229-2-3, FT1229-3-4 & FT1231-100-XX	XX is the hose size
LifeSense® preparation	ET0100-005	6" x 48" sander with guard and ET0100-001 orbital guide
Hose assembly Bench top crimper Pre-programmed serial production crimper Swager Assembly cleaning system	ET5050 Mark IX ET1455-L4 & ET1455-K5	Small hose diameter bench mount cleaning kit (1/4" thru 1 1/4" bench mount launcher with 7 hose nozzles) & large hose diameter cleaning kit (1/4" thru 4 1/2", nozzles, case, brass coupling, 2 adapter rings & locking ring)
Post assembly Proof test table Capping machine	FT1261 FT1555-BM	Bench mount production heat shrink machine with timer. Produces 50 ft lengths, for hoses up to 2"

Assembly equipment

Hose assembly crimp machines

Variable crimp machine – Portable

ET1187-001

Bench Mount



ET1187-002

Truck Mount



NEW! While being our most economical variable crimp machine to date, the new ET1187 machine boasts a broad crimp capability with a new “ease-of-use” that is sure to please hose assemblers in the field.

Crimp machine part numbers

ET1187-001	Bench mount machine, no pump, no tooling (includes bracket)—for premium hose GH681/H180, GH781/H280, GH493/H430)
ET1187-002	Truck mount machine, no pump, no tooling (includes bracket)—for premium hose GH681/H180, GH781/H280, GH493/H430)
ET1187-003	Bench mount machine, no pump, no tooling (includes bracket)—for Winner hose EC115, EC215, EC415
ET1187-004	Truck mount machine, no pump, no tooling (includes bracket)—for Winner hose EC115, EC215, EC415
ET1187C-0017	Bench Mount Bracket (separate)
ET1187C-0019	Truck Mount Bracket (separate)

Specifications

Dimensions: 22” High x 9” Wide x 11” Deep

Weight – 65 lbs

Available with bench and truck mount brackets

- Aeroquip TTC series braided fittings and applicable hoses in sizes 1/4” through 1-1/4”
- Aeroquip 4S series spiral fittings and applicable hoses in sizes 3/8” through 1”
- Eaton Winner two-piece braided fittings and applicable hoses in sizes 1/4” through 1-1/4”

Features

- Can be mounted on service vehicles or bench tops
- Can be used remotely, 65lbs
- Can be powered with virtually any 10,000 psi hydraulic power source (minimum of 36 cu. inch pump reservoir capacity is required)
- Utilizes existing FT1380 dies

Benefits

- Color coded collar for core hose products makes setup fast and easy
- Easily transported between job sites
- Versatile power source options
- Lower investment cost than other variable crimpers

Pump part numbers*

ET1000PK-001	2-Stage Hand Pump
ET1000PK-002	Air/Hydraulic Pump
ET1000PK-003	110 Volt Electric Pump
ET1000PK-004	12 Volt DC Electric Pump

* These pump kits include the pump, connecting hose assembly, and all of the adapters necessary to connect the pump to the ET1187 crimp machine.

Accessory part numbers

T-400-G	1.5 oz. Tube, High Efficiency PTFE Grease
FF91455	16 oz. Can, High Efficiency PTFE Grease

Die cage Part number	1 Wire braid TTC/Winner	2 Wire braid TTC/Winner	Spiral hose 4S fitting	ET4020TP-0002	ET4020TP-0003
FT1380-200-M150	-4	-4		X	X
FT1380-200-M180	-6	-4†		X	X
FT1380-200-M210	-8	-6	-6	X	X
FT1380-200-M240	-10	-8	-8††	X	X
FT1381-200-M280	-12	-10, -12†	-8, -10	X	X
FT1380-200-M320		-12	-12	X	X
FT1380-200-M370	-16	-16		X	X
FT1380-200-M420			-16		X
FT1382-200-M465	-20	-20			X

† - Die cage used to crimp Winner hose with two piece Winner fitting.

†† - Die cage used to crimp Winner hose with 4S fitting **Note:** Additional dies and die cage assemblies also available. Refer to website or contact Eaton.

Variable crimp machines

FT1380 ProCrimp



The ProCrimp 1380 crimp machine from Eaton crimps all your hose needs up to and including –20 SAE100R15 hose styles and the popular MatchMate Plus hose and fittings program (shown with optional die holder kit FT1380–2–4).

The ProCrimp 1380 is electronically controlled to give fast, accurate crimps the first time and every time you need a hose assembly. The electronic keypad is easy to adjust, with up to 10 programmable crimp settings. For hose styles and sizes used less frequently simply enter the 3 digit code of that hose.

Ordering instructions

FT1380–115 115V crimp machine 50/60 Hz
FT1380–230 230V crimp machine 50/60 Hz

Electrical requirements

USA: FT1380–115 standard machine uses 115V, 50/60 Hz, 1.5 hp

Brazil: FT1380–1–2 standard machine uses 230V, 50/60 Hz, 1.5 hp

Australia: FT1380–230 standard machine uses 230V, 50/60 Hz, 1.5 hp

Canada: FT1380–115CSA, FT1380-230CSA. Requires CSA (Canadian Standards Association) approval. The FT1380–115CSA and FT1380-230CSA are CSA approved and this is noted on their nameplates.

Accessory part numbers

FT1380–2–3	FT1330 to FT1380 Die cage conversion kit — back plate, bolts and instructions necessary to convert an FT1330 die cage to an FT1380 die cage. Simply remove the FT1330 back plate and replace it with the new FT1380 back plate.
FT1380–2–4	Optional die holder kit — Kit includes 4 die holder plates each of which will hold 2 die cages. Holes are pre-drilled on base of ProCrimp machine to accept these 4 plates.
FT1380-4	Optional fitting backstop—Kit includes backstop and 5/32" hex wrench. The backstop allows the 1380 to crimp PTFE hose and be utilized for a fitting locator to increase efficiency.
T-400-G	1.5 oz. Tube, high efficiency PTFE grease
FF91455	16 oz. Can, high efficiency PTFE grease

Die cage Part number	1 Wire braid TTC/Winner	2 Wire braid TTC/Winner	Spiral hose 4S fitting	ET4020TP-0002	ET4020TP-0003
FT1380-200-M150	-4	-4		X	X
FT1380-200-M180	-6	-4 [†]		X	X
FT1380-200-M210	-8	-6	-6	X	X
FT1380-200-M240	-10	-8	-8 ^{††}	X	X
FT1381-200-M280	-12	-10, -12 [†]	-8, -10	X	X
FT1380-200-M320		-12	-12	X	X
FT1380-200-M370	-16	-16		X	X
FT1380-200-M420			-16		X
FT1382-200-M465	-20	-20	-20		X

[†] - Die cage used to crimp designated hose diameter with two piece Winner fitting.

^{††} - Die cage used to crimp Winner hose with 4S fitting

Note: Additional dies and die cage assemblies also available. Refer to website or contact Eaton.

Assembly equipment

Hose assembly crimp machines

Variable crimp machines

ET1280 Crimp machine OBSOLETE - SEE FT1380 ON PAGE L-5



The ET1280 machine boasts a broad crimp capability with an ease-of-use that is sure to please hose assemblers. The ET1280 will handle virtually all hose styles through -20 SAE100R13 hose and fittings. All die cages, crimp diameters and approved hose and fitting combinations are identical to the popular FT1380 & ET1187 crimp machines.

Two configurations

The adjustable model allows the machine to be oriented to the preferred angle that the operator desires. This adjustable model may be ordered separately or with your choice of three power options, including a high volume hand pump, a turbo air/hydraulic power unit or a 12-volt DC power unit.

The upright model comes standard with a work light and a 110-volt, 50/60 Hz, 1.5 HP electric power unit.

Ordering instructions

- ET1280-001** Machine base, no pump, no tooling
- ET1280-005** 110 volt, 1 1/2 HP electric pump, no tooling (upright model)

Separate pump options

FT1310-2-9	12 VDC Pump
FT1380P-2-2	2-Stage hand pump
T-480-3	Turbo air/hydraulic pump

Tool packages

Die Cage Part Number	1 Wire braid TTC/Winner	2 Wire braid TTC/Winner	Spiral hose 4S fitting	Spiral hose TTC12 fitting	ET4020TP-0003
FT1380-200-M150	-4	-4			X
FT1380-200-M180	-6	-4†			X
FT1380-200-M210	-8	-6	-6	-6	X
FT1380-200-M240	-10	-8	-8††	-8††	X
FT1381-200-M280	-12	-10, -12†	-8, -10	-8, -10	X
FT1380-200-M320		-12	-12	-12	X
FT1380-200-M370	-16	-16			X
FT1380-200-M420			-16	-16	X
FT1382-200-M465	-20	-20	-20	-20	X

† - Die cage used to crimp designated hose diameter with two piece Winner fitting.

†† - Die cage used to crimp Winner hose with 4S fitting

Note: Additional dies and die cage assemblies also available. Refer to website or contact Eaton.

Variable crimp machines

FT1390 ProCrimp

Crimp assembly machine



All styles from 3/16" through 2" I.D. including four and six spiral wire requiring internal skive crimp style fittings.

Features

- Front-end loading design
- Electronic key pad control of crimp diameter
- Power return stroke, return limit control
- Drop-in tooling (crimp die cages)
- Backstop fitting locator
- Width 29"; Depth 28"; Height 49"; Weight 825 lbs.
- Worklamp

Ordering instructions

FT1390-115 Aeroquip crimp machine, 115V, single phase, 50/60 Hz, 1 hp motor

FT1390-230 Aeroquip crimp machine, 230V, single phase, 50/60 Hz, 1 hp motor

T-400-G 1.5 oz. Tube, high efficiency PTFE grease

FF91455 16 oz. Can, high efficiency PTFE grease

Canada: FT1390-115CSA, FT1390-230CSA. Requires CSA (Canadian Standards Association) approval. The FT1390-115CSA and FT1390-230CSA are CSA approved.

Crimp die cages

Eaton crimp die cages provide simple "drop-in" tooling for the FT1390 crimp machine. See Crimp Die Cage Applications chart or contact Eaton. Refer to website for current crimp specifications.

Die cage part number	1 wire braid TTC/Winner	2 wire braid TTC/Winner	Spiral hose 4S fitting	Spiral hose 6S fitting	ET4040TP-0007	ET4040TP-0008
FT1307-200-M150	-4	-4			X	
FT1307-200-M180	-6				X	
FT1307-200-M210	-8	-6	-6		X	
FT1307-200-M240	-10	-8			X	
FT1307-200-M280	-12	-10, -12†	-8, -10		X	
FT1209-200-82		-12			X	
FT1307-200-M370	-16	-16			X	
FT1307-200-M420	-20††		-16		X	
FT1307-200-M465	-20	-20			X	
FT1307-200-M520	-24				X	
FT1307-200-M550	-32††	-24			X	
FT1307-200-M690	-32	-32			X	
FT1209-200-82			-12		X	
FT1209-200-15		-24†				
FT1209-200-46		-20†				
*FT1390-200-14			-20			X
*FT1390-200-20			-24			X
*FT1390-200-23			-32			X
*FT1390-200-15				-20		
*FT1390-200-16				-24		
*FT1390-200-21				-32		

† - Die cage used to crimp designated hose diameter with two piece Winner fitting. †† - Die Cage used to crimp Winner Hose with TTC Fitting. **Note:** Additional dies and die cage assemblies also available. Refer to website or contact Eaton. *Die cages are hinged for ease of use when crimping large elbows.

FT1330-XL

MatchMate Plus fitting locators

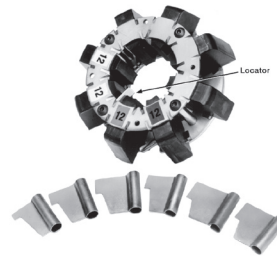

For use with FT1380 and FT1330 "M" Series die cages

Consistent crimping of MatchMate Plus fittings is greatly simplified when using new fitting locators.

The locators are designed for easy installation and use on the Eaton FT1380 or FT1330 "M" series die cages noted below.

Locator kit - ordering instructions

The locator kits can be ordered as part number FT1330-XL. Each kit contains locators to accommodate -4, -6, -8, -10, -12 and -16 MatchMate Plus fittings and installation instructions.

Locator suffix	Die cage suffix	MatchMate Plus hoses			
		GH663, GH194	GH793, GH195	GH781	GH493
-4, -4P	-M150	-4	-4	-4	
-6, -6P	-M180	-6			
	-M210		-6	-6	-6
-8, -8P	-M240	-8	-8	-8	
-10, -10P	-M280		-10	-10	-8
-12, -12P	-M320	-12	-12	-12	-12
-16	-M370	-16	-16	-16	-16
None required	-M465		-20	-20	-20

Assembly equipment

Hose assembly crimp machines

Crimp cages for FT1380

Specialty crimp die cages

Tooling	Tooling capabilities	
Die cage part #	Hose size	Hose style
FT1380-275-M070	-03	PTFE
FT1380-275-M090	-03 Synflex, -04, -05 PTFE	Synflex, PTFE
FT1380-275-M120	-04 Synflex, -06 PTFE	Synflex, PTFE
FT1382-275-M370	-16	Two-piece Winner
FT1382-275-M520	-20	6S
*FT1380-275-R5-04	-04	Truck and fuel 100R5
*FT1380-275-R5-05	-05	Truck and fuel 100R5
*FT1380-275-R5-06	-06	Truck and fuel 100R5
*FT1380-275-R5-08	-08	Truck and fuel 100R5
*FT1380-275-R5-10	-10	Truck and fuel 100R5
*FT1380-275-R5-12	-12	Truck and fuel 100R5
*FT1380-275-R5-16	-16	Truck and fuel 100R5
*FT1380-275-R5-20	-20	Truck and fuel 100R5

*Tooling above for use with Aeroquip hose and fittings

Tooling compatibility chart

Crimp machines

Size	FT1008	FT1049	ET1187	FT1204	FT1208	FT1209	FT1244	FT1307	FT1310	FT1320	FT1330	FT1340	FT1360	FT1370	FT1380	FT1380P	FT1390
FT1008-100	X																
FT1049-100		X															
FT1204-100				X		X ¹	X	X ¹				X ¹	X ¹				X ¹
FT1208-100					X												
FT1209-200						X		X				X	X				X
FT1307-200						X		X				X	X				X
FT1310-200									X								
FT1330-200										X	X						
FT1330-275										X	X						
FT1380-200			X											X	X	X	
FT1380-201			X											X	X	X	
FT1380-275			X											X	X	X	
FT1390-200						X		X				X	X				X

¹ Individual die. Requires the use of die cage kit FT1307-2-9 or removable die cage FT1307-2-13.

Die cage repair kit

Complete kit, less dies

Die cage

To repair	Order
FT1380-200-size	FT1380-2-9
FT1380-275-size	FT1380-2-9
FT1380-201-size	FT1380-2-9A

Crimp cages for FT1390

Specialty crimp die cages

Tooling		Tooling capabilities	
Die cage part #	Hose size	Hose style	
FT1209-200-14	-20	4S	
FT1209-200-15	-20	6S	
FT1209-200-16	-24	6S	
FT1209-200-20	-24	4S	
FT1209-200-21	-32	6S	
FT1209-200-23	-32	4S	
FT1307-200-M070	-03 PTFE	PTFE	
FT1307-200-M090	-03 Synflex, -04, -05 PTFE	Synflex, PTFE	
FT1307-200-M120	-04 Synflex, -06 PTFE	Synflex, PTFE	

Note: Additional dies and die cage assemblies also available. Refer to website or contact Eaton

Note: FT1209-200-size & FT1390-200-size are for use with internal skive and 4S/6S fittings (SAE100R11 & SAE100R13 hose styles).

Note: FT1390-200-size dies cages are hinged to allow ease of use when crimping large elbows

Barrel crimp die cages

Die cage part #	Hose size	Hose style
FT1307-200-R5-04	-04	Truck and fuel 100R5
FT1307-200-R5-05	-05	Truck and fuel 100R5
FT1307-200-R5-06	-06	Truck and fuel 100R5
FT1307-200-R5-08	-08	Truck and fuel 100R5
FT1307-200-R5-10	-10	Truck and fuel 100R5
FT1307-200-R5-12	-12	Truck and fuel 100R5
FT1307-200-R5-16	-16	Truck and fuel 100R5
FT1307-200-R5-20	-20	Truck and fuel 100R5
FT1307-200-R5-24	-24	Truck and fuel 100R5
FT1307-200-R5-32	-32	Truck and fuel 100R5
*FT1392-200-R5-24	-24	Truck and fuel 100R5
*FT1392-200-R5-32	-32	Truck and fuel 100R5

*Hinged die cage

Note: Tooling above for use with Weatherhead hose and fittings

Die cage repair kits

Die cage part #	Order
FT1307-200-size	FT1307-2-9
FT1390-200-size	FT1390-2-9
FT1209-200-size	FT1209-2-9

Assembly equipment

Hose assembly crimp machines

L

Programmable crimp machines

ET5040 - OBSOLETE - SEE ET5050 ON PAGE L-11

ET5040



The ET5040 is pre-programmed with all of Eaton's hose and hose fitting crimp specifications, crimp profile details, and machine settings in order to crimp to the required specifications

Crimp capacity

Spiral hose:
up to 2" (DN51)

Braided hose:
up to 3" (DN80)

Industrial hose:
up to 4" (DN102)*

Mounting

Free standing with adjustable telescoping legs

Shipped without oil in the reservoir. Approved oil must be added prior to operation.

Size

Legs fully extended: 52" (1321 mm) high

Legs fully retracted" 36" (914 mm) high (centerline of crimp head)

Crimp force

280 ton (2800 KN)

Reservoir capacity

13.2 gallons (50 liters)

Hydraulic oil

Industrial grade HM or HV46 ISO 6743/4

Total weight (without mounting rack & dies)

1,047 lbs (475 Kg)

Available power options

230V 3 Phase 50/60 Hz
380V 3 Phase 50/60 Hz
400V 3 Phase 50/60 Hz
420V 3 Phase 50/60 Hz
440V 3 Phase 50/60 Hz
460V 3 Phase 50/60 Hz
480V 3 Phase 50/60 Hz

Part no.	Package description
ET5040-001-230	ET5040 230V 3 phase (50/60 Hz) crimp machine with telescoping legs (includes calibration tooling)
ET5040-001-230KT	ET5040-001-230 machine, calibration tooling, die installation tool, standard die package, adapter die package, double foot pedal and machine mounted storage rack
ET5040-001-380	ET5040 380V 3 phase (50/60 Hz) crimp machine with telescoping legs (includes calibration tooling)
ET5040-001-380KT	ET5040-001-380 machine, calibration tooling, die installation tool, standard die package, adapter die package, double foot pedal and machine mounted storage rack
ET5040-001-400	ET5040 400V 3 phase (50/60 Hz) crimp machine with telescoping legs (includes calibration tooling)
ET5040-001-400KT	ET5040-001-400 machine, calibration tooling, die installation tool, standard die package, adapter die package, double foot pedal and machine mounted storage rack
ET5040-001-420	ET5040 420V 3 phase (50/60 Hz) crimp machine with telescoping legs (includes calibration tooling)
ET5040-001-420KT	ET5040-001-420 machine, calibration tooling, die installation tool, standard die package, adapter die package, double foot pedal and machine mounted storage rack
ET5040-001-440	ET5040 440V 3 phase (50/60 Hz) crimp machine with telescoping legs (includes calibration tooling)
ET5040-001-440KT	ET5040-001-440 machine, calibration tooling, die installation tool, standard die package, adapter die package, double foot pedal and machine mounted storage rack
ET5040-001-460	ET5040 460V 3 phase (50/60 Hz) crimp machine with telescoping legs (includes calibration tooling)
ET5040-001-460KT	ET5040-001-460 machine, calibration tooling, die installation tool, standard die package, adapter die package, double foot pedal and machine mounted storage rack
ET5040-001-480	ET5040 480V 3 phase (50/60 Hz) crimp machine with telescoping legs (includes calibration tooling)
ET5040-001-480KT	ET5040-001-480 machine, calibration tooling, die installation tool, standard die package, adapter die package, double foot pedal and machine mounted storage rack
ET5040C-0001*†	Adapter die package (Supplied with ET5040 crimp machines. Required for use with ET5040DC style dies and used to all calibrate machine.)
ET5040C-0004*	Die installation tool
ET5040C-0006	Automatic backstop
ET5040C-0007	Manual backstop
ET5040C-0009	Viewing mirror
ET5040C-0014*	Machine mounted die storage rack (includes insert holders)
ET5040C-0016	Table top die storage rack (includes insert holders)
ET5040C-0019*†	Calibration tool (supplied with ET5040 crimp machines)
ET5040C-0020*	Double pedal foot switch
ET5040C-0022	430"U" die package
ET5040C-0023*	Includes 11 of the most popular standard ET5040DC style die sets
ET5040DC-M320S †	32mm die set
ET5040DC-MXXX	Standard die sets
ET5040PBL-MXXX	Large bore industrial hose die sets
ET4001C-0017	Magnetic work lamp

*Components included in machine kit packages "KT"

†Calibration tooling (supplied with all ET5040 base machines)

Programmable crimp machines

ET5050



The ET5050 comes pre-programmed with all of Eaton's hose and hose fitting crimp specifications, crimp profile details, and machine settings in order to crimp to Eaton's specifications.

Crimp capacity

Spiral hose: up to 2" (DN51)
Braided hose: up to 3" (DN80)
Industrial hose: up to 4" (DN102)*

*With master dies, selective hoses and fitting terminal end designs

Size

Height: 66.93" (1700 mm)
Width: 23.62" (599 mm)
(center line of crimp head)
Length: 47.24 (2299 mm)

Note: Minimum of 36" of perimeter clearance is recommended for safety and maintenance.

Crimp force

280 ton (2800 KN)

Reservoir capacity

32 gallons (121 liters)

Hydraulic oil

Industrial grade AW46 (ISO 46) hydraulic oil

Total weight (without mounting rack and dies)

1,653.5 lbs (750 Kg)

Available power options

230V 3 Phase 50/60 Hz

380V 3 Phase 50/60 Hz

400V 3 Phase 50/60 Hz

420V 3 Phase 50/60 Hz

440V 3 Phase 50/60 Hz

460V 3 Phase 50/60 Hz

480V 3 Phase 50/60 Hz

Shipped without oil in the reservoir. Approved oil must be added prior to operation.

Part no.	Package description
ET5050-001-230	ET5050 230V 3 Phase (50/60 Hz) Crimp Machine with Telescoping Legs (Includes Calibration Tooling)
ET5050-001-230KT	ET5050-001-230 Machine, Calibration Tooling, Die Installation Tool, Standard Die Package, Adapter Die Package, Double Foot Pedal and Machine Mounted Storage Rack
ET5050-001-380	ET5050 380V 3 Phase (50/60 Hz) Crimp Machine with Telescoping Legs (Includes Calibration Tooling)
ET5050-001-380KT	ET5050-001-380 Machine, Calibration Tooling, Die Installation Tool, Standard Die Package, Adapter Die Package, Double Foot Pedal and Machine Mounted Storage Rack
ET5050-001-400	ET5050 400V 3 Phase (50/60 Hz) Crimp Machine with Telescoping Legs (Includes Calibration Tooling)
ET5050-001-400KT	ET5050-001-400 Machine, Calibration Tooling, Die Installation Tool, Standard Die Package, Adapter Die Package, Double Foot Pedal and Machine Mounted Storage Rack
ET5050-001-420	ET5050 420V 3 Phase (50/60 Hz) Crimp Machine with Telescoping Legs (Includes Calibration Tooling)
ET5050-001-420KT	ET5050-001-420 Machine, Calibration Tooling, Die Installation Tool, Standard Die Package, Adapter Die Package, Double Foot Pedal and Machine Mounted Storage Rack
ET5050-001-440	ET5050 440V 3 Phase (50/60 Hz) Crimp Machine with Telescoping Legs (Includes Calibration Tooling)
ET5050-001-440KT	ET5050-001-440 Machine, Calibration Tooling, Die Installation Tool, Standard Die Package, Adapter Die Package, Double Foot Pedal and Machine Mounted Storage Rack
ET5050-001-460	ET5050 460V 3 Phase (50/60 Hz) Crimp Machine with Telescoping Legs (Includes Calibration Tooling)
ET5050-001-460KT	ET5050-001-460 Machine, Calibration Tooling, Die Installation Tool, Standard Die Package, Adapter Die Package, Double Foot Pedal and Machine Mounted Storage Rack
ET5050-001-480	ET5050 480V 3 Phase (50/60 Hz) Crimp Machine with Telescoping Legs (Includes Calibration Tooling)
ET5050-001-480KT	ET5050-001-480 Machine, Calibration Tooling, Die Installation Tool, Standard Die Package, Adapter Die Package, Double Foot Pedal and Machine Mounted Storage Rack
ET5040C-0001*†	Adapter Die Package (Supplied with ET5050 Crimp Machines. Required for use with ET5040DC Style Dies and used to All Calibrate Machine.)
ET5040C-0004*	Die Installation Tool
ET5040C-0006	Automatic Backstop
ET5040C-0007	Manual Backstop
ET5050C-0009	Viewing Mirror
ET5040C-0014*	Machine Mounted Die Storage Rack (Includes Insert Holders)
ET5040C-0016	Table Top Die Storage Rack (Includes Insert Holders)
ET5040C-0019*†	Calibration Tool (Supplied with ET5050 Crimp Machines)
ET5040C-0020*	Double Pedal Foot Switch
ET5040C-0023*	Includes 11 of the Most Popular Standard ET5040DC Style Die Sets
ET5040DC-M320St	32mm Die Set
ET5040DC-MXXX	Standard Die Sets
ET5040PBL-MXXX	Large Bore Industrial Hose Die Sets
ET4001C-0017	Magnetic Work Lamp

*Components included in machine kit packages "KT"

†Calibration tooling (supplied with all ET5050 base machines)

Note: Please note that ET5050 shares dies crimp components and some accessories with the ET5040.

Assembly equipment

Hose assembly crimp machines

Dies and Kits for ET5040 and ET5050

ET5040 DC

Standard die for ET5040



Note: Please note that ET5050 shares die crimp components and accessories with the ET5040.

For more information go to ET5050 Crimp Machine Operator's Manual E-EQCR-TT003-E

ET5040 Standard die part numbers

Capability of crimping Eaton hose products ranging from -3 (3/16") through -40 (2 1/2") in hydraulic hose constructions. The ET5040C-0023 kit includes the (11) most popular dies required to crimp Eaton's most common hose product lines.

The standard ET5040DC dies require the use of the **ET5040C-0001** adapter dies.

These die packages are used for hydraulic hoses and industrial hoses with a finished crimp diameter up to 3.46 in. (88mm).

Standard die set part number	Die size		Die length		Minimum		Crimp range maximum	
	mm	in	mm	in	mm	in	mm	in
ET5040DC-M070S	7,0	0.276	82,0	3.23	7,0	0.28	9,0	0.35
ET5040DC-M090S	9,0	0.354	82,0	3.23	9,0	0.35	12,0	0.47
ET5040DC-M120S	12,0	0.472	82,0	3.23	12,0	0.47	15,0	0.59
ET5040DC-M150S*	15,0	0.590	82,0	3.23	15,0	0.59	18,0	0.71
ET5040DC-M180S*	18,0	0.709	82,0	3.23	18,0	0.71	21,0	0.83
ET5040DC-M210S*	21,0	0.827	82,0	3.23	21,0	0.83	24,0	0.95
ET5040DC-M240S*	24,0	0.945	82,0	3.23	24,0	0.95	28,0	1.10
ET5040 DC-M280S*	28,0	1.102	82,0	3.23	28,0	1.10	32,0	1.26
ET5040DC-M320S††	32,0	1.259	82,0	3.23	32,0	1.26	37,0	1.46
ET5040DC-M355S	35,5	1.398	82,0	3.23	35,5	1.40	39,5	1.56
ET5040DC-M370S*	37,0	1.457	82,0	3.23	37,0	1.46	42,0	1.66
ET5040DC-M420S*	42,0	1.654	82,0	3.23	42,0	1.66	46,5	1.83
ET5040DC-M450S	45,0	1.772	82,0	3.23	45,0	1.77	50,0	1.97
ET5040DC-M465S*	46,5	1.831	82,0	3.23	46,5	1.83	52,0	2.05
ET5040DC-M505S	50,5	1.988	82,0	3.23	50,5	1.99	54,0	2.13
ET5040DC-M520S*	52,0	2.047	82,0	3.23	52,0	2.05	55,0	2.17
ET5040DC-M550S*	55,0	2.165	82,0	3.23	55,0	2.17	60,0	2.36
ET5040DC-M570S	57,0	2.244	82,0	3.23	57,0	2.24	64,0	2.52
ET5040DC-M590S	59,0	2.323	82,0	3.23	59,0	2.32	66,0	2.60
ET5040DC-M620S	62,0	2.441	82,0	3.23	62,0	2.44	70,0	2.76
ET5040DC-M690S*	69,0	2.717	82,0	3.23	69,0	2.72	73,0	2.87
ET5040DC-M720S	72,0	2.835	82,0	3.23	72,0	2.84	78,0	3.07
ET5040DC-M775S	77,5	3.051	82,0	3.23	77,5	3.05	85,5	3.37
ET5040DC-M790S	79,0	3.110	82,0	3.23	79,0	3.11	88,0	3.46

*Included in the ET5040-0023 standard die kit.

††Supplied with all ET5040 crimp machines and required for calibration.

Require ET5040C-0001 adapter die.

Each set includes 8 individual dies.

ET5040C-0001

Adapter dies

Note: Please note that ET5050 shares die crimp components and accessories with the ET5040.

ET5040C-0001 adapter dies

Eaton adapter dies are supplied with all ET5040 base machines and are required for use with Eaton standard ET5040DC style dies. Adapter dies are inserted into the crimp head, providing proper alignment for the ET5040DC style dies. ET5040DC style dies are installed directly into the adapter die segments.

Dies and Kits for ET5040 and ET5050

ET5040PBL

Large bore die for ET5040

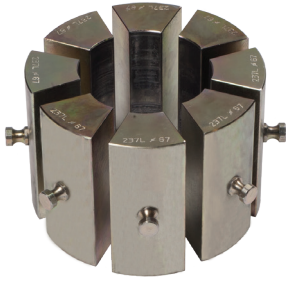

Note: Please note that ET5050 shares die crimp components and accessories with the ET5040

ET5040 large bore die part numbers

Capability of crimping Eaton hose products ranging up to -64 (4") in certain constructions. The large bore ET5040 dies do not require an adapter die and are inserted one segment at

a time. The large bore dies are typically used for large I.D. Eaton Industrial hose and large hydraulic hose.

Standard die set part number	Die size		Die length		Minimum		Crimp range maximum	
	mm	in	mm	in	mm	in	mm	in
ET5040PBL-M740	74,0	2.913	118,0	4.65	74,0	2.92	83,0	3.26
ET5040PBL-M780	78,0	3.070	118,0	4.65	78,0	3.07	86,0	3.38
ET5040PBL-M840	84,0	3.307	118,0	4.65	84,0	3.31	92,0	3.62
ET5040PBL-M860	86,0	3.386	118,0	4.65	86,0	3.39	94,0	3.70
ET5040PBL-M900	90,0	3.543	118,0	4.65	90,0	3.55	99,0	3.89
ET5040PBL-M960	96,0	3.800	118,0	4.65	96,0	3.80	105,0	4.13
ET5040PBL-M1030	103,0	4.055	118,0	4.65	103,0	4.06	113,0	4.44
ET5040PBL-M1060	106,0	4.173	126,0	4.96	106,0	4.18	116,0	4.56
ET5040PBL-M1110	110,0	4.331	126,0	4.96	110,0	4.33	121,0	4.76
ET5040PBL-M1160	116,0	4.567	126,0	4.96	116,0	4.57	127,0	4.99
ET5040PBL-M1210	121,0	4.764	126,0	4.96	121,0	4.77	133,0	5.23
ET5040PBL-M1260	126,0	4.961	126,0	4.96	126,0	4.96	138,0	5.43
ET5040PBL-M1310	131,0	5.157	126,0	4.96	131,0	5.16	144,0	5.66

Each set includes 8 individual dies

ET5040 and ET5050 Crimp Components and Accessories

Get more information on Crimp Components and Accessories in the Eaton ET5040 Crimp Machine: E-EQCR-TT001-E1 and ET5050 Crimp Machine E-EQCR-BB001-E.

Assembly equipment

Hose preparation

L

ET9100, ET9200 & ET9300 Series hose saws

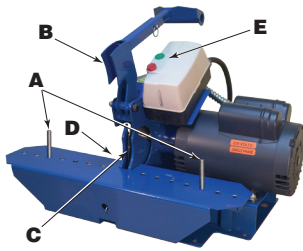

Clean Cuts • Less Smoke • Longer Life

ET9100/200/300 hydraulic hose cutting system is break-through technology using a toothed blade, cutting with the backs of each tooth, so the blade does not take a kerf. The saw bends the hose into the blade spreading the cut edges to avoid burning and smoking.

How it works

With the ET9100/200/300 hydraulic hose saws the hose is positioned across two pins (A) and moved into the blade (C) by a feed foot (B) using a pulldown handle for better leverage on

heavy hose. The feed motion causes the hose to stretch at the point of contact with the blade, allowing it to separate as it is cut (see image at right). This separation allows the hose to pass clear of the saw blade with NO friction, NO heating and NO DEBRIS! A vacuum hose (not shown) is attached to a vacuum port (D) to remove any tiny amount of debris or smoke during cutting. Improved safety using a 110V on/off switch (E) with a magnetic contactor. When power is lost, the saw will not turn back on independently. Comes with advanced scalloped blade.

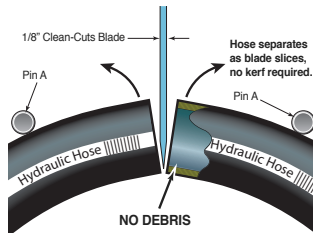

WARNING The user must exercise extreme care when operating any Eaton assembly equipment with powered moving components. Safety glasses must be worn at all times when using any Eaton assembly equipment.

Read and understand the owners and operators manual before attempting to operate any equipment.

Eaton personnel are available to answer any questions, please call Eaton, 14615 Lone Oak Road, Eden Prairie, MN 55344, 952-937-9800. Eaton assembly equipment is designed to be used only with Aeroquip and Winner hose and Eaton hose fittings.

ET9100 Series



ET9100 series saws

Model	Motor	7 inch Blade	Cutting capacity
ET9100-07-110	1-1/2 HP, 110 VAC (1 Phase), 60 Cycle, 17** Amp, 3,430 RPM	7" OD x .093 THK X 3/4" arbor	1-1/4" ID x 4 wire hydraulic hose
ET9100-07-110CSA†	1-1/2 HP, 110 VAC (1 Phase), 60 Cycle, 17** Amp, 3,430 RPM	7" OD x .093 THK X 3/4" arbor	1-1/4" ID x 4 wire hydraulic hose
ET9100-07-22060	2 HP, 220 VAC (1 Phase), 60 Cycle, 11* Amp, 3,430 RPM	7" OD x .093 THK X 3/4" arbor	1-1/4" ID x 4 wire hydraulic hose
ET9100-07-22050	2 HP, 220 VAC (1 Phase), 50 Cycle, 11* Amp, 2,865 RPM	7" OD x .093 THK X 3/4" arbor	1-1/4" ID x 4 wire hydraulic hose

* Requires 15 Amp Circuit ** Requires 20 Amp Circuit †Canadian Standards Association Rated

ET9100 series saw blades

Model	Type	Blade	Cutting capacity
ET9100C-07-AS	Advanced scallop blade	7" OD x .093 THK X 3/4" arbor	1-1/4" ID x 4 wire hydraulic hose
ET9100C-07-MS	Micro-slotted blade	7" OD x .093 THK X 3/4" arbor	1-1/4" ID x 4 wire hydraulic hose
ET9100C-07-SM	Smooth blade	7" OD x .093 THK X 3/4" arbor	1-1/4" ID x 4 wire hydraulic hose
ET9100C-07-SC	Scalloped blade	7" OD x .093 THK X 3/4" arbor	1-1/4" ID x 4 wire hydraulic hose
ET9100C-07-SL	Slotted blade	7" OD x .093 THK X 3/4" arbor	1-1/4" ID x 4 wire hydraulic hose

ET9200 Series



ET9200 series saws

Model	Motor	10 inch Blade	Cutting capacity
ET9200-10-220	5 HP, 220 VAC (1 Phase), 60 Cycle, 21 Amp, 3,490 RPM	10" OD x .125 THK X 40 mm	2" ID x 6 wire hydraulic hose ‡
ET9200-10-22050	3 HP, 220 VAC (1 Phase), 50 Cycle, 4 Amp, 2,865 RPM	10" OD x .125 THK X 40 mm	2" ID x 6 wire hydraulic hose ‡
ET9200-10-220 CSA †	5 HP, 220 VAC (1 Phase), 60 Cycle, 21 Amp, 3,490 RPM	10" OD x .125 THK X 40 mm	2" ID x 6 wire hydraulic hose ‡
ET9200-10-220-3	3 HP, 220 VAC (3 Phase), 60 Cycle, 11* Amp, 3,490 RPM	10" OD x .125 THK X 40 mm	2" ID x 6 wire hydraulic hose ‡
ET9200-10-220-3 CSA †	3 HP, 220 VAC (3 Phase), 60 Cycle, 11* Amp, 3,490 RPM	10" OD x .125 THK X 40 mm	2" ID x 6 wire hydraulic hose ‡
ET9200-10-440-3	3 HP, 440 VAC (3 Phase), 60 Cycle, 4 Amp, 3,490 RPM	10" OD x .125 THK X 40 mm	2" ID x 6 wire hydraulic hose ‡
ET9200-10-12V	4 HP, 12 VDC, 10,000 RPM	10" OD x .125 THK X 40 mm	2" ID x 4 wire hydraulic hose
ET9200-10-24V	4 HP, 24 VDC, 10,000 RPM	10" OD x .125 THK X 40 mm	2" ID x 4 wire multi-spiral hydraulic hose

* Requires 15 Amp Circuit ** Requires 20 Amp Circuit
 †Canadian Standards Association Rated ‡ Diamond Blade Recommended for Frequent 6 Wire Cutting

ET9200 series saw blades

Model	Type	Blade size	Cutting capacity
ET9200C-10-AS	Advanced scallop blade	10" OD x .125 THK X 40 mm arbor	2" ID x 6 wire hydraulic hose ‡
ET9200C-10-MS	Micro-slotted blade	10" OD x .125 THK X 40 mm arbor	2" ID x 6 wire hydraulic hose ‡
ET9200C-10-D	Diamond blade	10" OD x .125 THK X 40 mm arbor	2" ID x 6 wire hydraulic hose ‡
ET9200C-10-SM	Smooth blade	10" OD x .125 THK X 40 mm arbor	2" ID x 6 wire hydraulic hose ‡
ET9200C-10-SC	Scalloped blade	10" OD x .125 THK X 40 mm arbor	2" ID x 6 wire hydraulic hose ‡
ET9200C-10-SL	Slotted blade	10" OD x .125 THK X 40 mm arbor	2" ID x 6 wire hydraulic hose ‡

ET9300 Series



ET9300 series saws

Model	Motor	14 inch Blade	Cutting capacity
ET9300-14-220	5 HP, 220 VAC (1 Phase), 60 Cycle, 21 Amp, 3,490 RPM	14" OD x .160 THK X 40 mm	2" ID x 6 wire hydraulic hose ‡ and 5" OD spiral wound hose
ET9300-14-22050	3 HP, 220 VAC (1 Phase), 50 Cycle, 11* amp, 3,490 RPM	14" OD x .160 THK X 40 mm	2" ID x 6 wire hydraulic hose ‡ and 5" OD spiral wound hose
ET9300-14-220-3	3 HP, 220 VAC (3 Phase), 60 Cycle, 11* Amp, 3,490 RPM	14" OD x .160 THK X 40 mm	2" ID x 6 wire hydraulic hose ‡ and 5" OD spiral wound hose
ET9300-14-440-3	3 HP, 440 VAC (3 Phase), 60 Cycle, 4 Amp, 3,490 RPM	14" OD x .160 THK X 40 mm	2" ID x 6 wire hydraulic hose ‡ And 5" OD spiral wound hose
ET9300-14-220-3 CSA †	3 HP, 220 VAC (3 Phase), 60 Cycle, 11* Amp, 3,490 RPM	14" OD x .160 THK X 40 mm	2" ID x 6 wire hydraulic hose ‡ and 5" OD spiral wound hose

* Requires 15 Amp Circuit ** Requires 20 Amp Circuit
 †Canadian Standards Association Rated ‡ Diamond Blade Recommended for Frequent 6 Wire Cutting

ET9300 series saw blades

Model	Type	Blade size	Cutting capacity
ET9300C-14-AS	Advanced scallop blade	14" OD x .160 THK X 40 mm arbor	2" ID x 4 wire hydraulic hose 5" OD spiral wound hose
ET9300C-14-MS	Micro-slotted blade	14" OD x .160 THK X 40 mm arbor	2" ID x 4 wire hydraulic hose 5" OD spiral wound hose
ET9300C-14-D	Diamond blade	14" OD x .160 THK X 40 mm arbor	2" ID x 4 wire hydraulic hose 5" OD spiral wound hose
ET9300C-14-SM	Smooth blade	14" OD x .160 THK X 40 mm arbor	2" ID x 4 wire hydraulic hose 5" OD spiral wound hose
ET9300C-14-SC	Scalloped blade	14" OD x .160 THK X 40 mm arbor	2" ID x 4 wire hydraulic hose 5" OD spiral wound hose
ET9300C-14-SL	Slotted blade	14" OD x .160 THK X 40 mm arbor	2" ID x 4 wire hydraulic hose 5" OD spiral wound hose

Assembly equipment

Hose preparation

L

Hose saw blades

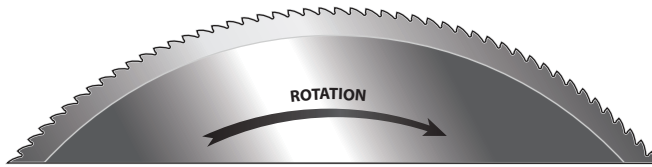

Advanced scalloped blades

Features advanced performance scalloped knife technology for cutting hydraulic spiral hose and wire helix hose resulting in cleaner cuts, faster cuts, no smoke, and longer blade life. Available in 6" to 14" sizes to fit Clean-Cuts™, Aeroquip®, Custom Crimp®, Gates®, Goodyear®, Imperial Eastman®, Parker®, Stratoflex®, Toledo®, and Weatherhead® saws.

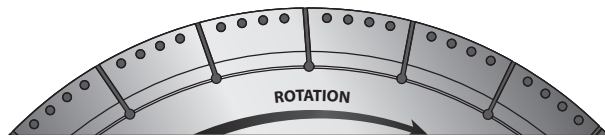

Diamond hydraulic hose blades

Exclusively designed for cutting heavy 4 and 6 wire hydraulic hoses. This diamond grinding technology cuts down by 60% the debris while cutting heavy hoses very quickly as opposed to using abrasive wheels. You will get a fantastic finish and make 5 – 10 second cuts in 2" hose.



Smooth beveled edge hydraulic hose blades

Smooth edge knife designed for the best finish when cutting light duty hoses like single wire braid, textile reinforced, poly or nylon reinforced, and Teflon® hoses.

Available in sizes 6"-14" to fit Clean-Cuts™, Aeroquip®, Custom Crimp®, Gates®, Goodyear®, Hydroscand®, Imperial Eastman®, O+P®, Parker®, Savage Stone®, Stratoflex®, Toledo®, and Weatherhead®.

Advanced scalloped blade

Model	Diameter	Thickness	Arbor	Eaton saw
ET9500C-06-AS	6"	0.093"	5/8"	-
ET9500C-07-AS	7"	0.093"	5/8"	-
ET9100C-07-AS	7"	0.093"	3/4"	ET9100
ET9500C-08-AS	8"	0.093"	5/8"	-
ET9500C-10-AS	10"	0.093"	3/4"	-
ET9500C-10-1-AS	10"	0.125"	1"	-
ET9200C-10-AS	10"	0.125"	40mm	ET9200
ET9500C-12-AS	12"	0.125"	1"	-
ET9500C-14-AS	14"	0.125"	1"	-
ET9300C-14-AS	14"	0.160"	40mm	ET9300

Diamond hydraulic hose blade

Model	Diameter	Thickness	Arbor	Eaton saw
ET9200C-10-D	10"	0.125"	40mm	ET9200
ET9300C-14-D	14"	0.160"	40mm	ET9300

Smooth beveled edge hydraulic hose blade

Model	Diameter	Thickness	Arbor	Eaton saw
ET9500C-07-SM	7"	0.093"	5/8"	-
ET9100C-07-SM	7"	0.093"	3/4"	ET9100
ET9500C-08-SM	8"	0.093"	5/8"	-
ET9500C-10-SM	10"	0.062"	5/8"	-
ET9500C-10-1-SM	10"	0.093"	3/4"	-
ET9200-10-1-SM	10"	0.093"	40mm	ET9200
ET9500C-10-2-SM	10"	0.125"	1"	-
ET9200C-10-SM	10"	0.125"	40mm	-
ET9500C-12-SM	12"	0.093"	1"	-
ET9500C-12-1-SM	12"	0.125"	1"	-
ET9500C-14-SM	14"	0.125"	1"	-
ET9300C-14-SM	14"	0.160"	40mm	ET9300
ET9500C-16-SM	16"	0.160"	1"	-
ET9500C-18-SM	18"	0.160"	1"	-
ET9500C-20-SM	20"	0.160"	1"	-
ET9500C-22-SM	22"	0.160"	1"	-
ET9500C-24-SM	24"	0.160"	1"	-
ET9500C-26-SM	26"	0.160"	1"	-

Hose saw blades

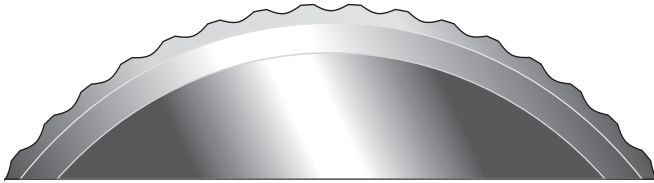

Notched scalloped hydraulic hose blades

Notched scalloped knives are designed for rough duty cutting on spiral hose up to 6 wire.

Available in sizes 6"-14" to fit Clean-Cuts™, Aeroquip®, Custom Crimp®, Gates®, Goodyear®, Hydroscand®, Imperial Eastman®, O+P®, Parker®, Savage®, Stone®, Stratoflex®, Toledo®, and Weatherhead®.

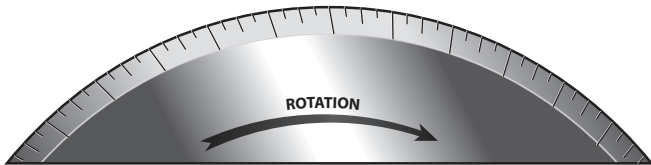

Micro-slotted smooth hydraulic hose blades

Features "new" micro-slotted smooth edge knife technology combining the better finishes of a double bevel knife with the more aggressive performance of a slotted knife. This is our most universal knife grind and will give you two times longer blade life than smooth edge knives. Used for cutting spiral hose, industrial hose, Teflon, PTFE, Kevlar, and metal hose.

Available in 6" to 14" sizes to fit Clean-Cuts™, Aeroquip®, Custom Crimp®, Gates®, Goodyear®, Imperial Eastman®, Parker®, Stratoflex®, Toledo®, and Weatherhead® saws.

Also available in 16" to 26" sizes to fit Hydroscand®, Finn Power®, Marken®, O+P®, Savage®, Stone®, Techmaflex® and Uniflex® saws.

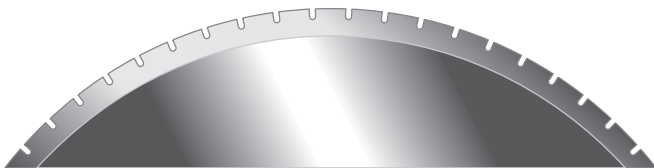

Slotted smooth hydraulic hose blades

Designed for cutting 4 to 6 wire spiral hoses, this high performance heavy duty slotted knife reduces pinching by skiving the sides of the hose while cutting.

Available in sizes 16" to 36" to fit on Finn Power®, Hydroscand®, Marken®, O+P®, Savage®, Stone®, Stratoflex®, Techmaflex® and Uniflex® saws.

Notched scalloped hydraulic hose blade

Model	Diameter	Thickness	Arbor	Eaton saw
ET9500C-07-SC	7"	0.093"	5/8"	-
ET9100C-07-SC	7"	0.093"	3/4"	ET9100
ET9500C-08-SC	8"	0.093"	5/8"	-
ET9500C-10-SC	10"	0.093"	3/4"	-
ET9500C-10-1-SC	10"	0.125"	1"	-
ET9200C-10-SC	10"	0.125"	40mm	ET9200
ET9500C-12-SC	12"	0.125"	1"	-
ET9500C-14-SC	14"	0.125"	1"	-

Micro-slotted smooth edge hydraulic hose blade

Model	Diameter	Thickness	Arbor	Eaton saw
ET9500C-06-MS	6"	0.093"	5/8"	-
ET9500C-07-MS	7"	0.093"	5/8"	-
ET9100C-07-MS	7"	0.093"	3/4"	ET9100
ET9500C-08-MS	8"	0.093"	5/8"	-
ET9500C-10-MS	10"	0.062"	5/8"	-
ET9500C-10-1-MS	10"	0.093"	3/4"	-
ET9200C-10-1-MS	10"	0.093"	40mm	ET9200
ET9500C-10-2-MS	10"	0.125"	1"	-
ET9200C-10-MS	10"	0.125"	40mm	ET9200
ET9500C-12-MS	12"	0.093"	1"	-
ET9500C-12-1-MS	12"	0.125"	1"	-
ET9500C-14-MS	14"	0.125"	1"	-
ET9300C-14-MS	14"	0.160"	40mm	ET9300
ET9500C-16-MS	16"	0.160"	1"	-
ET9500C-18-MS	18"	0.160"	1"	-
ET9500C-20-MS	20"	0.160"	1"	-
ET9500C-22-MS	22"	0.160"	1"	-
ET9500C-24-MS	24"	0.160"	1"	-
ET9500C-26-MS	26"	0.160"	1"	-

Slotted smooth hydraulic hose blade

Model	Diameter	Thickness	Arbor	Eaton saw
ET9500C-07-SL	7"	0.093"	5/8"	-
ET9100C-07-SL	7"	0.093"	3/4"	ET9100
ET9500C-08-SL	8"	0.093"	5/8"	-
ET9500C-10-SL	10"	0.062"	5/8"	-
ET9500C-10-1-SL	10"	0.093"	3/4"	-
ET9200C-10-1-SL	10"	0.093"	40mm	ET9200
ET9500C-10-2-SL	10"	0.125"	3/4"	-
ET9500C-10-3-SL	10"	0.125"	1"	-
ET9200C-10-SL	10"	0.125"	40mm	ET9200
ET9500C-12-SL	12"	0.093"	1"	-
ET9500C-12-1-SL	14"	0.125"	1"	-
ET9500C-14-SL	14"	0.125"	1"	-
ET9300C-14-SL	14"	0.160"	40mm	ET9300
ET9500C-16-SL	16"	0.160"	1"	-
ET9500C-18-SL	18"	0.160"	1"	-
ET9500C-20-SL	20"	0.160"	1"	-
ET9500C-20-1-SL	20"	0.160"	40mm	-
ET9500C-21-SL	21"	0.160"	38mm	-
ET9500C-22-SL	22"	0.160"	50mm	-
ET9500C-24-SL	24"	0.160"	1"	-
ET9500C-26-SL	26"	0.160"	1"	-

Assembly equipment

Hose preparation

L

Skiving tools

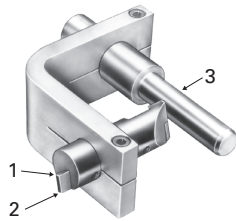

FT1229-size

Silver chromate mandrel
(for reusable fittings)

- 1 FT1229-2-3 blade holder
- 2 FT1229-3-4 skive blade
- 3 FT1229-100-size

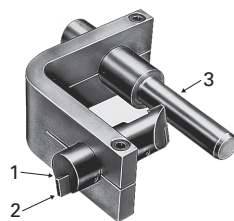

FT1230-size

Yellow chromate mandrel
(for crimp fittings)

- 1 FT1229-2-3 blade holder
- 2 FT1229-3-4 skive blade
- 3 FT1230-100-size

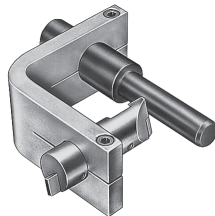

FT1231-size

Black oxide mandrel
(for internal skive crimp fittings)

For skiving rubber covered wire reinforced hoses

When selecting skive tools, refer to Eaton document A-EQCR-TM001-E for proper skive length of hose sizes.

Hose size	Reusable fittings		Crimp fittings		Crimp internal skive fittings	
	FT1229	Skive length	FT1230	Skive length	FT1231	Skive Length
-03			-3	0.45		
-04	-4	0.91	-4	0.76		
-05			-5	0.76		
-06	-6	1.15 1.23 1.30	-6	0.90		
-08	-8	1.25	-8	1.04	-8	1.34
-10	-10	1.25	-10	1.11		
-12	-12	1.40	-12 ¹	1.21 1.31	-12	1.40
		-12B ³		2.40		
-16	-16	1.65	-16	1.30	-16	1.85
		-16B ³		2.30		
-20	-20	2.09		1.66	-20	2.05
		-20A ⁴		1.52		
		-20B ³		1.88		
-24	-24	1.95	-24 ¹	1.74 1.64 2.18	-24	2.05
		-24B ⁵		2.60		
-32	-32 ²	2.05			-32	2.30

1 Adjustable tool. 2 FT1229-32 tool is used for reusable and crimp fittings.
3 For FC606. 4 For GH493. 5 For GH493 and FC254.

FT1240

Internal skive tooling



FT1240-100-size



FT1240-150-size

* When tooling begins to wear, contact customer service for information on how to exchange for sharpened tooling.

Internal skive tool	FC254	FC323 FC324 FC273	FC325	FC606
FT1240-150-8	-08			
FT1240-100-12		-12	-12	
FT1240-150-12	-12			
FT1240-150-16	-16	-16	-16	-16
FT1240-100-20		-20	-20	
FT1240-150-20	-20			-20
FT1240-100-24		-24	-24	
FT1240-150-24	-24			
FT1240-100-32		-32	-32	
FT1240-150-32	-32			

FT1279

Auger attachment

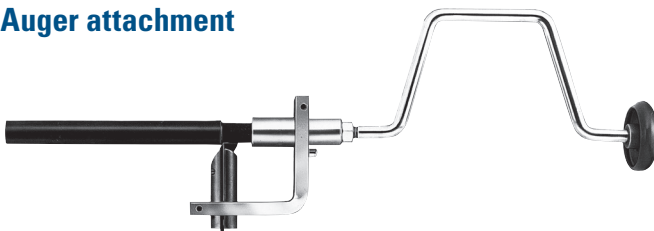

The FT1279 auger attachment permits efficient skiving of rubber covered wire reinforced hose.

Designed for use with FT1229, FT1230 and FT1231 skiving tools, the FT1279 auger attachment promotes quick completion of hand skiving operations.

Reusable fitting assembly equipment

FT1097

Portable reusable hose assembly machine



Fitting Specifications

Any screw together reusable hose fitting with a hex size 21/8" or smaller

Features

- Bench or stand mounted
- Easy to operate
- Convenient foot switch
- U.L. listed
- 102 RPM

Electrical Requirements

1/2 hp reversible, variable speed, universal motor; as the torque increases the speed decreases. 110V AC, single phase, 25-60 Hz, or 220V, AC, single phase, 25-60 Hz.

Ordering Instructions

FT1097-1-1	Base machine, 110V
FT1097-1-2	Base machine, 220V
FT1013-2-2	Machine stand
FT1220-10	Optional assembly tool kit (see page L-22)
FT1097-2-1	Optional vise kit (see below)

FT1097-2-1

Vise kit for FT1097 machine

The optional vise kit for the FT1097 reusable hose assembly machine includes all hardware necessary to install the kit. Reusable hose fitting sockets are conveniently held secure during assembly.

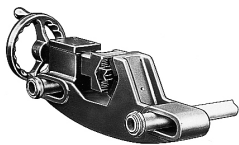

Assembly equipment

Hose preparation

L

Reusable hose assembly machine

FT1013

Portable reusable hose assembly machine



Fitting Specifications

Fabric and single wire braid, -04 through -40

Double wire and 4 spiral wire, -04 through -32

Features

- Quick acting wrench type chuck
- Easy to operate
- Safety guard
- Versatile
- Safety snap type switch
- Safety footswitch
- 36 rpm
- 45" x 56" x 46", 170 lbs.

Electrical requirements

1/2 hp reversible, variable speed, universal motor; as the torque increases the speed decreases. 110V AC, single phase, 25-60 Hz, or 220V AC, single phase, 25-60 Hz.

Ordering Instructions

FT1013-1-5	Base machine, 110V, with vise
FT1013-1-6	Base machine, 220V, with vise
FT1013-1-3	Base machine, 110V, with stand, vise and socketing tool
FT1013-1-4	Base machine, 220V, with stand, vise and socketing tool
FT1013-1-1	Base machine, 110V, with tool kit, stand, vise and socketing tool
FT1013-1-2	Base machine, 220V, with tool kit, stand, vise and socketing tool
FT1013-2-1	Vise
FT1013-2-2	Stand
1562	Tool kit
FT1281	Socketing tool (see below)

FT1281

Socketing tool

For use with stand mounted FT1013 and FT1097 Portable Hose Assembly Machine. (The FT1281 socketing tool must be accompanied by the FT1097-2-1 vise kit (see page L-19) when used on the FT1097 portable hose assembly machine.)

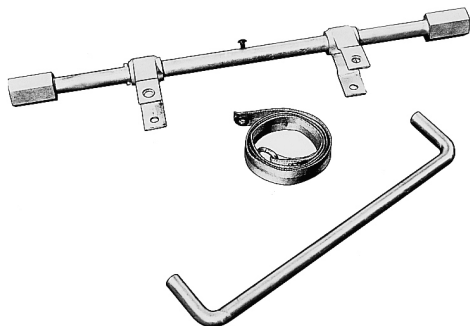

Reusable hose assembly machine

FT1028

Production reusable hose assembly machine

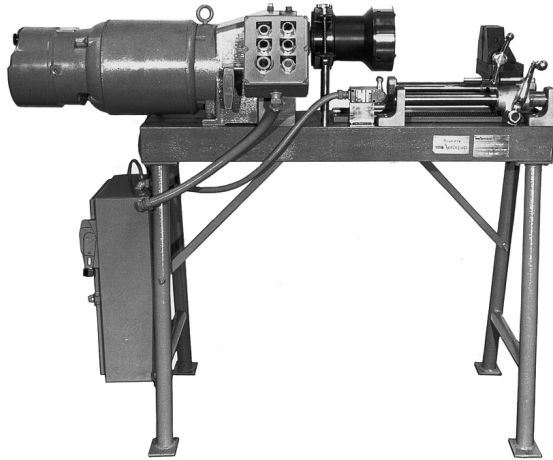

Fitting Specifications

Screw together fittings: Fabric or wire braided hose up to -32
4 spiral wire hose up to -24

Features

- High volume production
- Ideal for 2 or 3 piece fittings
- 4 speed transmission; 90 rpm, 120 rpm, 210 rpm, 400 rpm
- Easy to operate
- Micrometer stop
- Electric brake
- U.L. listed
- 24" x 62" x 32"; 550 lbs.

Electrical requirements

220/440V, 3 phase, 60 Hz.

Ordering instructions

FT1028-1-5 Base machine

FT1234

Drop-in socket holder

Designed for use with the FT1028 assembly machine, the FT1234 drop-in socket holder prevents rotation of the socket during assembly and provides a back stop to ensure consistent location of the socket.

Part number FT1234	Hex Size (inches)	Hose style	Socket part number and size
-100	9/16	2807-4	1206-4
-101	5/8	2807-5, 1503-4, FC300-04, FC350-04, FC321-04	1206-5, 1210-4
-102	11/16	2807-6, 1503-5, FC300-5, FC350-5, FC321-05	1206-6, 1210-5
-104	13/16	1503-6, 1509-4, FC300-6, FC350-6, FC321-06	1210-6, 4010-4
-105	7/8	2807-8	1206-8
-106	15/16	1503-8, FC300-08, FC350-08, FC321-08	1210-8
-200	1	2807-10	1206-10, FC3214-10
-201	1	1509-6, 1508-6	4007-6, 4010-6, 4013-6
-202	1-1/8	1503-10, 1509-8, 1508-8, FC300-10, FC350-10, FC321-10	4013-8
-203	1-1/8	2807-12	1206-12
-204	1-1/4	1503-12, 1509-10, FC300-12, FC350-12	1210-12, 4010-10
-205	1-3/8	2807-16	1212-16, FC3214-16
-206	1-7/16	1503-16, FC300-16, FC350-16, FC321-16	1212-16
-207	1-1/2	1508-12	4007-12, 4013-12
-208	1-5/8		FC3214-20
-209	1-3/4	1503-20, FC300-20, FC350-20	1212-20

FT1033

Assembly mandrels

Designed for use with the FT1028 assembly machine, the FT1033 assembly mandrels. Secured in the chuck they speed the volume production of Eaton Aeroquip three piece reusable hose fittings.

Part number	Fitting number	Part number	Fitting number
FT1033-1	FC9215-0404	FT1033-23	401-6
FT1033-2	FC9215-0504	FT1033-24	411-6
FT1033-3	FC9215-0808	FT1033-25	411-8 401-8
FT1033-4	FC9215-0506	FT1033-26	411-10 401-10
FT1033-5	FC9215-1010	FT1033-27	401-12
FT1033-6	FC9210-0606	FT1033-28	411-12
FT1033-7	FC9210-1212	FT1033-29	406-16
FT1033-8	FC9211-0606	FT1033-30	411-16
FT1033-9	FC9211-1212	FT1033-31	406-20
FT1033-10	FC9211-1616	FT1033-32	411-20
FT1033-11	FC9211-2020	FT1033-33	406-24
FT1033-13	FC9212-0204 FC9212-0404 FC9216-0404	FT1033-34	411-24
FT1033-14	FC9212-0406 FC9212-0606	FT1033-35	406-32
FT1033-15	FC9212-0608 FC9212-0808	FT1033-36	411-32
FT1033-16	FC9212-0810	FT1033-37	412-2-4 412-4-4
FT1033-17	FC9212-1212	FT1033-38	412-4-5
FT1033-18	FC9212-1616	FT1033-39	412-4-6
FT1033-19	FC9212-2020	FT1033-40	412-6-12
FT1033-21	411-4 401-4	FT1033-41	412-8-10 412-12-10
FT1033-22	411-5 401-5	FT1033-42	412-12-12

Assembly equipment

Hose preparation

Reusable fitting accessories

FT1220-10

Reusable fitting assembly mandrels



Specifications

The FT1220-10 kit includes all assembly mandrels listed for -4 through -20 for the assembly of Eaton 411, 401, and 406 reusable hose fittings. Individual mandrels may also be ordered by using the part numbers to the right.

Thread type	SAE 37° (JIC)	SAE 45° PTT	30°
Use with fitting nos.	411	401	406
Dash size			
-4	1582-4S	1582-4S	
-5	1582-5S	1582-5S	
-6	583-6S	1582-6S	
-8	1582-8S	1582-8S	
-10	1582-10S	1582-10S	
-12	583-12S	1582-12S	
-16	1563-16S		1561-16S
-20	1563-20S		1561-20S
-24	1563-24S		1561-24S
-32	1563-32S		

Kit part number	Fitting part number	Thread types	Size range
1562 (not shown)	401, 406, 411, 412	SAE 45°, SAE 37° (JIC), PTT, NPTF	-4 thru -32
1597 (not shown)	401, 412	SAE 45°, NPTF	-4 thru -12
1598 (not shown)	411, 412	SAE 37° (JIC), NPTF	-4 thru -32
1599 (not shown)	411, 412	SAE 37° (JIC), NPTF	-4 thru -12
FT1220-10	401, 406, 411, 412	SAE 45°, SAE 37° (JIC), PTT, NPTF	-4 thru -20

FT1038A

PTFE hose tool



Hose specifications

Smooth bore PTFE Hose, -03, -04, -05, -06, -08, -10 and -12

Features

- Small
- Hand held tool

Ordering instructions

FT1038A PTFE hose tool (-03 thru -12)

FT1038B PTFE hose tool (-16, -20)

F2015

SOCKETLESS fitting bench mounted assembly machine

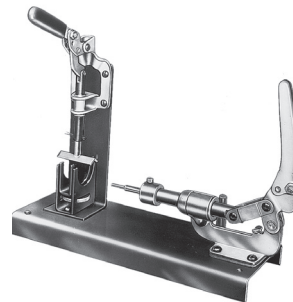

Hose specifications

SOCKETLESS hose, all sizes

Features

- Fast, hand assembly
- Bench mounted
- Hose is securely held
- Mandrels included

Ordering instructions

F2015 Complete machine

Reusable fitting and Hose cutting accessories

FT1081

PTFE hose assembly tool kit

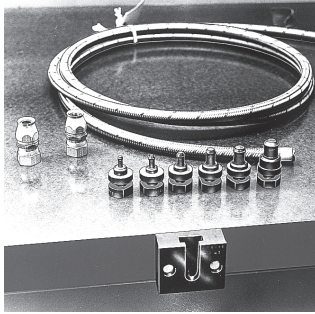

Hose specifications

Smooth bore PTFE hose, -03, -04, -05, -06, -08, -10 and -12 hose

FT1090-3-10-4 and FT1090-3-10-5 are useful wire flare tools to use in conjunction with kit FT1081.

Features

- Inexpensive
- Easy to use
- Seats PTFE tube against sleeve

Ordering instructions

FT1081 Complete tool kit

Includes:

FT1081-3-	Mandrel holder
FT1081-3-2-3	Mandrel -3 hose
FT1081-3-2-4	Mandrel -4 hose
FT1081-3-3-5	Mandrel -5 hose
FT1081-3-4-6	Mandrel -6 hose
FT1081-3-5-8	Mandrel -8 hose
FT1081-3-6-10	Mandrel -10 hose
FT1081-3-7-12	Mandrel -12 hose
FT1081-16	Mandrel -16 hose
FT1081-20	Mandrel -20 hose

Hose cutting accessories

4573-00000

Multi-line hose separation tool



Designed for separation of tri-, quad- and five-line hose

Replacement blade

Part No. 4523-04005

T-191

Plastic tube and hose cutter

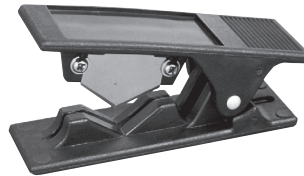

Only 2-7/8" long, the versatile T-191 offers quick and clean square cuts on 1/16" to 1/2" O.D. plastic tubing and non-wire reinforced hose. The T-191 can be either bench or wall mounted and offers the safety of closing automatically when not in use.

Replacement blade

Part No: T-191B
(one per package)

4523-04006

Hand-held hose cutter



Handy tool for cutting Eaton Synflex hose 1/8-inch to 1/2-inch in diameter. Blades are replaceable. Vinyl cushioned grips

Replacement blade

Part No. 4523-04005

Assembly equipment

Hose proof test stands

L

FT1312

Hose proof test stand

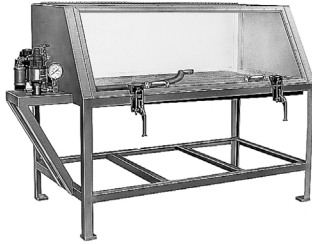

Hose specifications

Assemblies up to 2" I.D., 6 spiral wire

Features

- Designed to use tap water, eliminating the need for a special test fluid
- Compact power unit is air driven
- Air regulator and gauge provide easy pressure adjustment and monitoring
- Tough transparent Lexan* lid
- 79" x 36" x 53", 550 lbs

Power unit

The power unit of the FT1312 tester is a compact, economical air driven hydraulic pump. It will provide sufficient hydraulic pressure to proof test any Aeroquip hose assembly, up to 22,000 psi

*Lexan is a General Electric trademark.

FT1261

Hose proof test stand



Hose specifications

Assemblies up to 2" I.D., 6 spiral wire in 50 ft. coil lengths

Features

- Designed to use tap water, eliminating the need for a special test fluid
- Air regulator and gauge provide easy pressure adjustment and monitoring
- Tough transparent Lexan* lid
- 96" x 84" x 54", 800 lbs

Power unit

The power unit of the FT1261 tester is a compact, economical air driven hydraulic pump. It will provide sufficient hydraulic pressure to proof test any Aeroquip hose assembly, up to 22,000 psi

*Lexan is a General Electric trademark.

FT1312 and FT1261 Standard adapter selection chart

Hose fitting* style and size	Fitting adapter part number	Pressure port adapter part number	Plug or cap part number
SAE 37°(JIC) swivel			
-4	2027-8-4S	**	900599-4
-5	2021-6-5S	2081-12-6S	900599-5
-6	2027-8-6S	**	900599-6
-8	2027-8-8S	**	900599-8
-10	2027-10-08S	**	900599-10
-12	2027-08-12S	**	900599-12
-16	2021-12-16S	**	900599-16
-20	2021-16-20S	2040-12-16S	900599-20
-24	2021-16-24S	2040-12-16S	900599-24
-32	2021-16-32S	2040-12-16S	900599-32
SAE 45° swivel			
-4	2000-06-4B	2081-12-6S	900599-4
-5	2000-06-5B	2081-12-6S	900599-5
-6	2000-06-6B	2081-12-6S	2001-6-6B, 2082-6S
-8	2000-12-8B	**	900599-8
-10	2000-12-10B	**	900599-10
-12	2000-12-12B	**	2001-8-12B, 2082-8S
Male pipe			
-2	2081-08-02S	2081-12-08S	2046-2-2S, 2082-2S
-4	2081-08-04S	2081-12-08S	2046-4-4S, 2082-4S
-6	2081-08-06S	2081-12-08S	2046-6-6S, 2082-6S
-8	2081-08-08S	**	2046-8-8S, 2082-8S
-12		**	2046-12-12S, 2082-12S
-16	2040-12-16S	**	2046-16-16S, 2082-16S
-20	2040-16-20S	2040-12-16S	2046-20-20S, 2082-20S
-24	2040-20-24S	2040-12-16S, 2040-16-20S	2046-24-24S, 2082-24S
-32	2040-24-32S	2040-12-16S, 2040-16-20S, 2040-20-24S	2046-32-32S, 2082-32S

*Two adapters are required per hose assembly to be tested.

**Internal Skive fittings only.

FT1058

Hose proof test stand

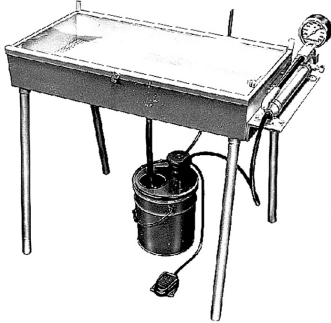

Features

- Pressure gauge
- Release valve
- Hand hydraulic pump
- Foot switch
- Fluid reservoir, use SAE 5 wt. hydraulic oil (oil not included)
- Electric fluid pump
- Safety lid
- Pressure port (3/4–14 NPTF Female Port)
- 42" x 22" x 9" (41" with legs), 75 lbs
- 10,000 psi maximum proof pressure

Electrical requirements

110V 60 Hz, single phase motor

Ordering instructions

1FT1058 as shown above.
Legs can be removed for bench mounting.

FT1058 Adapter selection chart

Hose fitting* style and size	Fitting adapter part number	Pressure port adapter part number	Plug or cap part number
SAE 37°(JIC) swivel			
-4	2021-6-4S	2081-12-6S	900599-4
-5	2021-6-5S	2081-12-6S	900599-5
-6	2021-12-6S	-	900599-6
-8	2021-12-8S	-	900599-8
-10	2021-12-10S	-	900599-10
-12	2021-12-12S	-	900599-12
-16	2021-12-16S	-	900599-16
-20	2021-16-20S	2040-12-16S	900599-20
-24	2021-16-24S	2040-12-16S	900599-24
-32	2021-16-32S	2040-12-16S	900599-32
SAE 45° swivel			
-4	2000-06-04B	2081-12-6S	900599-4
-5	2000-06-05B	2081-12-6S	900599-5
-6	2000-06-06B	2081-12-6S	2001-6-6B, 2082-6S
-8	2000-12-08B	-	900599-8
-10	2000-12-10B	-	900599-10
-12	2000-12-12B	-	2001-8-12B, 2082-8S
Male pipe			
-2	2081-8-2S	2081-12-8S	2046-1-2S, 2082-2S
-4	2081-8-4S	2081-12-8S	2046-4-4S, 2082-4S
-6	2081-8-6S	2081-12-8S	2046-6-6S, 2082-6S
-8	2081-12-8S	-	2046-8-8S, 2082-8S
-12		-	2046-12-12S, 2082-12S
-16	2040-12-16S	-	2046-16-16S, 2082-16S
-20	2040-16-20S	2040-12-16S	2046-20-20S, 2082-20S
-24	2040-20-24S	2040-12-16S, 2040-16-20S	2046-24-24S, 2082-24S
-32	2040-24-32S	2040-12-16S, 2040-16-20S, 2040-20-24S	2046-32-32S, 2082-32S

*Adapters are available for other hose fitting styles. Contact Eaton.

Assembly equipment

Contamination control products

L

FT1455 Series Projectile cleaning system



FT1455 Series projectile cleaning system

FT1455 Series is focused on eliminating contamination in hydraulic systems. Contamination control is crucial during the preparation processes in assembling fittings on hose, tubes, and pipes.

These systems shoot the FT1355 Series cleaning projectiles through hose, tubes, and pipe assemblies to successfully remove rubber dust and metal particles arising from the hydraulic hose cutting process, remove metal flashings from the hose assembly process (crimping), and remove contaminated oil from hoses, tubes and pipes prior to installation in hydraulics systems.

Features

- Provides industry leading ISO cleanliness levels
- Simple and robust construction
- Available in hand-held and bench-mount configurations
- Ideal for portable small volume applications, and large volume production applications
- Broad variety of projectile and nozzle types and sizes to match application needs
- Minimal setup, works off shop air (80–110 psi)
- Capability: 1/8" to 4 1/2" ID hose, tube or pipe
- Available in kits or individual replacement hardware components
- Kits available with and without projectiles

Typical Applications

Hydraulics	<ul style="list-style-type: none">• Removes rubber dust and metal particles from the hydraulic hose cutting process• Removes metal flash from the crimping process on hose and tubes• Removal of contaminated oil from hoses, tubes and pipes in hydraulic systems
Pneumatics	<ul style="list-style-type: none">• Eliminates rubber contamination, metal particles, contaminated oil and moisture that causes breakdowns and inefficiency
Heat exchangers & condenser	<ul style="list-style-type: none">• Eliminates contamination that reduces heat transfer resulting in low level performance
Steam boilers	<ul style="list-style-type: none">• Removes most scaling in steam pipes for maintenance servicing
Air conditioning & refrigeration	<ul style="list-style-type: none">• Eliminates minute particles in copper tubes and coolant lines that affect system performance
Oxygen & gas	<ul style="list-style-type: none">• Eliminates oil, grease and other contaminants from copper or S/S tubing
Oil, gas & chemical processing	<ul style="list-style-type: none">• Efficient cleaning of pipes as part of service maintenance
Earthmoving equipment	<ul style="list-style-type: none">• Maintenance reduction in flushing time and filter usage
Automotive & servicing	<ul style="list-style-type: none">• Cleaning of fuel lines and brake lines prior to assembly and servicing of components
Food & beverage	<ul style="list-style-type: none">• Product recovery retrieval of product from lines. Reducing or eliminating solvents or detergents
Gun barrels	<ul style="list-style-type: none">• To remove rust, scale or powder residue much faster than brushing or swabbing

For more information on the Contamination Control Products go to E-HOIN-TT032-E2.

FT1455 Series Hardware

FT1455-L1



Hand held projectile cleaning hardware for small hose diameters (up to 1-1/4" hose ID)

- Capability – For use with 1/8" through 1/4" ID hose, tube or pipe assemblies
- Construction – Simple construction with durable brass and aluminum parts with rigid plastic handle
- Form factor – Hand-held, portable - ideal for mobile applications

- Typical applications: small volume hose shop environments
- Includes hand-held launcher hardware only. Does not include adapter rings and nozzles for operation. Intended for replacement purposes only

FT1455-L2



Hand held projectile cleaning hardware for medium hose diameters (up to 2" hose ID)

- Capability – For use with 1/8" through 2" ID hose, tube or pipe assemblies
- Construction - Precision machined aluminum with fully anodized components
- Form factor – Hand-held, portable – ideal for harsh environments and heavy use

- Typical applications: Production hose and tube shops, mobile hose fabricators and mobile applications
- Includes hand-held launcher hardware only. Does not include adapter rings and nozzles for operation. Intended for replacement purposes only

FT1455-L3



Hand held projectile cleaning hardware for large hose diameters (up to 3-1/2" hose ID)*

- Capability – For use with 1/8" through 3-1/2" ID hose, tube or pipe assemblies
- Construction - Precision machined aluminum with fully anodized components
- Form factor – Hand-held, portable – ideal for harsh environments and heavy use

- Typical applications: Production hose and tube shops, mobile hose fabricators and mobile applications
- Includes hand-held launcher hardware only. Does not include adapter rings and nozzles for operation. Intended for replacement purposes only

FT1455-L4



Bench mount projectile cleaning hardware kit for small hose diameters (up to 1-1/4" hose ID)

- Capability – For use with 1/8" through 1-1/4" ID hose, tube or pipe assemblies
- Construction – Stainless steel housing with anodized aluminum components
- Form factor – Bench mount – ideal for production assemblies (1.2 second cycle time)

- Typical applications: Production hose and tube shops
- Includes bench mount launcher hardware, 5 micron air filter, pneumatic foot switch and twin line air hose and 7 nozzles for hose ID ranging from 1/4" through 1-1/4"

Note: For proper operation the following are required:

- 80 psi (5.5 Bar) minimum to 110 psi (7.5 Bar) maximum air pressure
- 1/2" ID air hose with a minimum of 55 SCFM (1.6 m³/min) air flow rate†
- 5 micron air filter and regulator with gauge are strongly suggested
- A large industrial compressor is strongly recommended
- A compressed air dryer is strongly recommended

†A minimum of 38 SCFM (1.1 m³/min) air flow rate at 80 psi (5.5 bar) is required for FT1455-L3 launcher

*FT1455-L3 can be converted to work on hose ID up to 4" with the addition of FT1455-N-45 4-1/2" aluminum locking nozzle.

Assembly equipment

Contamination control products

L

FT1455 Series

Projectile cleaning system kits

FT1455-K1



Hand held projectile cleaning kit for small hose diameters (up to 1-1/4" hose ID)

- Capability – For use with 1/4" through 1-1/4" ID hose, tube or pipe assemblies
- Construction – Simple construction with durable brass and aluminum parts with rigid plastic handle

- Form factor – Hand-held, portable – ideal for mobile applications
- Typical applications – small volume hose shop environments

FT1455-K2



Hand held projectile cleaning starter kit for small hose diameters (up to 1-1/4" hose ID)

- Capability – For use with 1/4" through 1-1/4" ID hose, tube or pipe assemblies
- Construction – Simple construction with durable brass and aluminum parts with rigid plastic handle

- Form factor – Hand-held, portable – ideal for mobile applications
- Typical applications – small volume hose shop environments.
- Catch can not included

FT1455-K3



Hand held projectile cleaning kit for medium hose diameters (up to 2" hose ID)

- Capability – For use with 1/4" through 2" ID hose, tube or pipe assemblies
- Construction – Precision machined aluminum with fully anodized components

- Form factor – Hand-held, portable – ideal for harsh environments and heavy use
- Typical applications – Production hose and tube shops, mobile hose fabricators and mobile applications

FT1455-K4



Hand held projectile cleaning kit for medium hose diameters (up to 2" hose ID)

- Capability – For use with 1/8" through 2" ID hose, tube or pipe assemblies
- Construction – Precision machined aluminum with fully anodized components

- Form factor – Hand-held, portable – ideal for harsh environments and heavy use
- Typical applications – Production hose and tube shops, mobile hose fabricators and mobile applications

FT1455-K5



Hand held projectile cleaning hardware kit for large hose diameters (up to 3-1/2" hose ID)

- Capability – For use with 1/8" through 4-1/2" hose, tube or pipe assemblies
- Construction – Precision machined aluminum with fully anodized components

- Form factor – Hand-held, portable – ideal for harsh environments and heavy use
- Typical applications – Production hose and tube shops, mobile hose fabricators and mobile applications

FT1455 Series Cleaning nozzles

Broad variety of nozzles are available allowing the operator to select the ideal nozzle for each application based on the different size and type of hoses, hose fittings, tube and pipe assemblies. All nozzle sizes are denoted by the projectile exit diameter (mm).



FT1455-N-HXX

Nozzles for hose assemblies

- Universal nozzle for use with hoses
- Also work on pipe, heavy walled tubing and many fitting configurations



FT1455-NT-XX

Nozzles for tube assemblies (Inch)

- Nominal inch tube nozzles have a lip on the inside that forms an airtight seal when tube is fully inserted into the nozzle



FT1455-J-XX

Nozzles for hose assemblies with JIC fittings

- Nozzles molded with 37° male flare on tip to fit female JIC fittings on hose assemblies



FT1455-NT-XXXXX

Nozzles for tube assemblies (Metric)

- Metric tube nozzles have a lip on the inside that forms an airtight seal when tube is fully inserted into the nozzle
- Metric tube nozzle designations utilize the largest wall thickness for a given outside diameter, but fit all smaller wall thicknesses as well

Part number	Description
FT1455-N-HXX	Nozzles for hose assemblies
FT1455-N-H06	Hose nozzle (1/4")
FT1455-N-H08	Hose nozzle (5/16")
FT1455-N-H10	Hose nozzle (3/8")
FT1455-N-H13	Hose nozzle (1/2")
FT1455-N-H16	Hose nozzle (5/8")
FT1455-N-H19	Hose nozzle (3/4")
FT1455-N-H25	Hose nozzle (1")
FT1455-N-H32	Hose nozzle (1 1/4")
FT1455-N-H38	Hose nozzle (1 1/2")
FT1455-N-H50	Hose nozzle (2")
FT1455-N-U55	Universal hose nozzle (1 1/8" thru 3 1/2")
FT1455-N-45	4 1/2" aluminum locking nozzle

FT1455-J-XX	Nozzles for hose assemblies with JIC fittings
FT1455-J-06	JIC nozzle (4 1/2")
FT1455-J-10	JIC nozzle (4 1/2")
FT1455-J-13	JIC/TUBE nozzle (-8, 1/2")
FT1455-J-16	JIC/TUBE nozzle (-10, 5/8")
FT1455-J-19	JIC/TUBE nozzle (-12, 3/4")
FT1455-J-25	JIC/TUBE nozzle (-16, 1" & 7/8")
FT1455-J-32	JIC/TUBE nozzle (-20, 1 1/4" & 1")
FT1455-J-38	JIC/TUBE nozzle (-24, 1 1/2")
FT1455-J-50	JIC/TUBE nozzle (-32, 2")

FT1455-NT-XX	Nozzles for tube assemblies (Inch)
FT1455-NT-32	TUBE nozzle 1 1/4" OD
FT1455-NT-06	TUBE nozzle 1/4" OD
FT1455-NT-03	TUBE nozzle 1/8" OD
FT1455-NT-10	TUBE nozzle 3/8" OD
FT1455-NT-08	TUBE nozzle 5/16" OD

FT1455-NT-XX	Nozzles for tube assemblies (Metric) Outside diameter X wall thickness
FT1455-NT-06x1.5	Metric tube nozzle UC-6 X 1.5
FT1455-NT-08x1.5	Metric tube nozzle UC-8 X 1.5
FT1455-NT-10x1.5	Metric tube nozzle UC-10 X 1.5
FT1455-NT-12x2.0	Metric tube nozzle UC-12 X 2.0
FT1455-NT-14x2.0	Metric tube nozzle UC-14 X 2.0
FT1455-NT-15x2.0	Metric tube nozzle UC-15 X 2.0
FT1455-NT-16x2.5	Metric tube nozzle UC-16 X 2.5
FT1455-NT-18x2.5	Metric tube nozzle UC-18 X 2.5
FT1455-NT-20x3.0	Metric tube nozzle UC-20 X 3.0
FT1455-NT-22x2.0	Metric tube nozzle UC-22 X 2.0
FT1455-NT-25x3.0	Metric tube nozzle UC-25 X 3.0
FT1455-NT-28x2.5	Metric tube nozzle UC-28 X 2.5
FT1455-NT-30x4.0	Metric tube nozzle UC-30 X 4.0
FT1455-NT-35x3.0	Metric tube nozzle UC-35 X 3.0
FT1455-NT-38x5.0	Metric tube nozzle UC-38 X 5.0
FT1455-NT-42x3.0	Metric tube nozzle UC-42 X 3.0
FT1455-NT-50x5.0	Metric tube nozzle UC-50 X 5.0
FT1455-4FFORX	Nozzle for use with flat face O-ring seal fittings (FROS)

Assembly equipment

Contamination control products

L

FT1455 Series

Adapter & locking rings

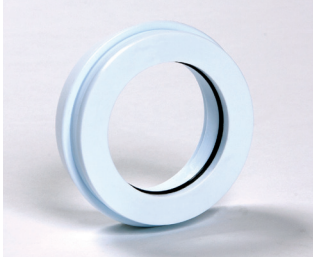

FT1455-L2-AR1

Adapter ring

Adapter ring for FT1455-L2 launcher to receive 1/8" thru 1-1/4" nozzles

- FT1455-L2-AR1 adapter ring fits the FT1455-L2 hand held launcher and all nozzle types and sizes between 1/8" and 1-1/4"



FT1455-L3-LR

Locking ring

3-1/2" aluminum locking ring for FT1455-L3 launcher

- FT1455-L3-LR locking ring fits FT1455-L3 hand held launcher, both FT1455-L3-AR2 & FT1455-L3-AR3 adapter rings, and FT1455-N-U55 Universal hose nozzle



FT1455-L3-AR2

Adapter ring

Adapter ring for FT1455-L3 launcher to receive 1/8" thru 1-1/4" nozzles

- FT1455-L3-AR2 adapter ring fits the FT1455-L3 hand held launcher and all nozzle types and sizes between 1/8" and 1-1/4"



FT1455-L3-AR3

Adapter ring

Adapter ring for FT1455-L3 launcher to receive 1-1/2" thru 2" nozzles

- FT1455-L3-AR2 adapter ring fits the FT145

FT1455 series Accessories



FT1455-NH25

Desktop nozzle holder

- The desktop nozzle holder is a great alternative to storing the nozzles in the carrying case
- Can be easily attached to the workbench and offers easy access during change overs and operation
- Accommodates all types of nozzles ranging from 1/4" to 2"



FT1455-QC

Quick release coupling

- Quick release coupling offers a quick disconnect and exchange of air supply to all 3 models of hand held projectile launchers
- Ideal for portable applications that require frequent disconnects



FT1455-CC

Carrying case

- Convenient carrying case to store and carry the hand held projectile launchers and relevant nozzles
- Works with all 3 models of hand held projectile launchers

FT1455 Operating Instructions



E-HOAI-CC001-E
FT1455-L1 Hand Launcher
Operating Instructions



E-HOAI-CC002-E
FT1455-L2 Hand Launcher
Operating Instructions



E-HOAI-CC003-E
FT1455-L3 Hand Launcher
Operating Instructions



E-HOAI-CC004-E
FT1455-L4 Bench Mount
Launcher Operating
Instructions

Assembly equipment

Contamination control products

L

FT1455 and FT1355 series

Recommended nozzles and cleaning projectiles for hoses and hose assemblies

Recommendations for hoses

Nominal hose diameter		Nozzle part no.	Cleaning projectile part no.
Inches	mm		
3/16	05	FT1455-N-H06	FT1355-H-06 -
1/4	06	FT1455-N-H06	FT1355-H-10 or FT1355-H-12
5/16	08	FT1455-N-H08	FT1355-H-12 or FT1355-H-14
3/8	10	FT1455-N-H10	FT1355-H-14 or FT1355-H-16
1/2	13	FT1455-N-H13	FT1355-H-18 or FT1355-H-20
5/8	16	FT1455-N-H16	FT1355-H-22 -
3/4	19	FT1455-N-H19	FT1355-H-26 -
1	25	FT1455-N-H25	FT1355-H-33 or FT1355-H-36
1 1/4	32	FT1455-N-H32	FT1355-H-40 or FT1355-H-45
1 1/2	38	FT1455-N-H38	FT1355-H-50 or FT1355-H-55
2	50	FT1455-N-H50	FT1355-H-60 or FT1355-H-65
2 1/2	63	FT1455-N-U55	FT1355-H-75 -
3	76	FT1455-N-U55	FT1355-H-85 -
3 1/2	89	FT1455-N-U55	FT1355-H-100 -
4	102	FT1455-N-45	- -
4 1/2	114	FT1455-N-45	- -

Recommendations for hose assemblies with ORS fittings

ORS fitting dash size	Nozzle part no.	Cleaning projectile part no.
-4	FT1455-4FFORX	FT1355-H-06 or FT1355-H-07
-6	FT1455-N-H06	FT1355-H-12 -
-8	FT1455-N-H10	FT1355-H-16 -
-10	FT1455-N-H13	FT1355-H-22 -
-12	FT1455-N-H16	FT1355-H-26 -
-16	FT1455-N-H19	FT1355-H-33 -
-20	FT1455-N-H25	FT1355-H-40 -

Recommendations for hose assemblies with Code 61 or 62 flanges

Code 61 or 62 flange dash size	Nozzle part no.	Cleaning projectile part no.
-8	FT1455-N-H10	FT1355-H-16
-10	FT1455-N-H13	FT1355-H-22
-12	FT1455-N-H16	FT1355-H-26
-16	FT1455-N-H19	FT1355-H-33
-20	FT1455-N-H25	FT1355-H-40
-24	FT1455-N-H32	FT1355-H-50
-32	FT1455-N-H32	FT1355-H-60

Recommendations for hose assemblies with JIC fittings

JIC fitting dash size	Nozzle part no.	Cleaning projectile part no.
-4	FT1455-J-06	FT1355-H-06 or FT1355-H-07
-6	FT1455-J-10	FT1355-H-12
-8	FT1455-J-13	FT1355-H-16
-10	FT1455-J-16	FT1355-H-22
-12	FT1455-J-19	FT1355-H-26
-16	FT1455-J-25	FT1355-H-33
-20	FT1455-J-32	FT1355-H-40
-24	FT1455-J-38	FT1355-H-50
-32	FT1455-J-50	FT1355-H-60

FT1455 and FT1355 series

Recommended nozzles and cleaning projectiles for pipes and tubes

Recommended nozzles and cleaning projectiles for pipes (inch)

SCH 40	Nozzle part #	Cleaning projectile part #	Abrasive projectile part #
1/4"	FT1455-N-H08	FT1355-H-14	FT1355-A-12
3/8"	FT1455-N-H13	FT1355-H-18	FT1355-A-16
1/2"	FT1455-N-H16	FT1355-H-20	FT1355-A-18
3/4"	FT1455-N-H19	FT1355-H-30	FT1355-A-26
1"	FT1455-N-H25	FT1355-H-36	FT1355-A-33
1 1/4"	FT1455-N-H32	FT1355-H-45	FT1355-A-40
1 1/2"	FT1455-N-H38	FT1355-H-55	FT1355-A-50
2"	FT1455-N-H50	FT1355-H-65	-
2 1/2"	FT1455-N-U55	FT1355-H-75	-
3"	FT1455-N-U55	FT1355-H-85	-
3 1/2"	FT1455-N-U55	FT1355-H-100	-

SCH 80	Nozzle part #	Cleaning projectile part #	Abrasive projectile part #
1/4"	FT1455-N-H06	FT1355-H-12	FT1355-A-10
3/8"	FT1455-N-H10	FT1355-H-16	FT1355-A-14
1/2"	FT1455-N-H13	FT1355-H-20	FT1355-A-16 or FT1355-A-18
3/4"	FT1455-N-H19	FT1355-H-26	FT1355-A-22
1"	FT1455-N-H25	FT1355-H-36	FT1355-A-30
1 1/4"	FT1455-N-H32	FT1355-H-45	FT1355-A-40
1 1/2"	FT1455-N-H38	FT1355-H-50	FT1355-A-45
2"	FT1455-N-H38	FT1355-H-60	FT1355-A-55
2 1/2"	FT1455-N-H50	FT1355-H-70	-
3"	FT1455-N-U55	FT1355-H-85	-
3 1/2"	FT1455-N-U55	FT1355-H-100	-

SCH 160	Nozzle Part #	Cleaning projectile part #	Abrasive projectile part #
1/2"	FT1455-N-H10	FT1355-H-16	FT1355-A-14
3/4"	FT1455-N-H16	FT1355-H-20	FT1355-A-18
1"	FT1455-N-H19	FT1355-H-30	FT1355-A-26
1 1/4"	FT1455-N-H25	FT1355-H-36	FT1355-A-33
1 1/2"	FT1455-N-H32	FT1355-H-45	FT1355-A-40
2"	FT1455-N-H38	FT1355-H-55	FT1355-A-45 or FT1355-A-50
2 1/2"	FT1455-N-H50	FT1355-H-65	FT1355-A-60
3"	FT1455-N-U55	FT1355-H-75	
4"	FT1455-N-U55	FT1355-H-100	

Recommended nozzles and cleaning projectiles for tubes (inch)

Outside diameter x wall thickness	Nozzle part #	Cleaning projectile part #	Abrasive projectile part #	Tube projectile part #
1/8" X 0.030"	FT1455-NT-3	-	-	-
1/4" X 0.035"	FT1455-NT-6	FT1355-H-10	FT1355-A-07	FT1355-T-06
1/4" X 0.049"	FT1455-NT-6	FT1355-H-08	FT1355-A-07	FT1355-T-06
1/4" X 0.065"	FT1455-NT-6	FT1355-H-07	-	FT1355-T-06
5/16" X 0.035"	FT1455-NT-8	FT1355-H-12	FT1355-A-10	FT1355-T-07
3/8" X 0.035"-0.049"	FT1455-NT-10	FT1355-H-14	FT1355-A-12	FT1355-T-10
3/8" X 0.065"	FT1455-NT-10	FT1355-H-12	FT1355-A-10	FT1355-T-10
1/2" X 0.035"	FT1455-J-13	FT1355-H-16	FT1355-A-16	FT1355-T-14
1/2" X 0.049"	FT1455-J-13	FT1355-H-16	FT1355-A-16	FT1355-T-12
1/2" X 0.065"	FT1455-J-13	FT1355-H-16	FT1355-A-14	FT1355-T-12
1/2" X 0.083"	FT1455-J-13	FT1355-H-14	FT1355-A-12	FT1355-T-12
5/8" X 0.049"	FT1455-J-16	FT1355-H-22	FT1355-A-20	FT1355-T-16
5/8" X 0.065"	FT1455-J-16	FT1355-H-20	FT1355-A-18	FT1355-T-16
5/8" X 0.083"	FT1455-J-16	FT1355-H-20	FT1355-A-18	FT1355-T-14
3/4" X 0.049"-0.065"	FT1455-J-19	FT1355-H-26	FT1355-A-24	FT1355-T-20
3/4" X 0.095"	FT1455-J-19	FT1355-H-22	FT1355-A-20	FT1355-T-18
7/8" X 0.049"	FT1455-J-25	FT1355-H-33	FT1355-A-30	FT1355-T-26
7/8" X 0.065"	FT1455-J-25	FT1355-H-30	FT1355-A-28	FT1355-T-22
7/8" X 0.095"	FT1455-N-H16	FT1355-H-28	FT1355-A-26	FT1355-T-22
1" X 0.065"	FT1455-J-32	FT1355-H-33	FT1355-A-30	FT1355-T-28
1" X 0.083"-0.095"	FT1455-J-32	FT1355-H-33	FT1355-A-30	FT1355-T-26
1" X 0.120"	FT1455-J-32	FT1355-H-30	FT1355-A-28	FT1355-T-26
1 1/4" X 0.065"	FT1455-NT-32	FT1355-H-40	FT1355-A-40	FT1355-T-33
1 1/4" X 0.083"	FT1455-NT-32	FT1355-H-40	FT1355-A-36	FT1355-T-33
1 1/4" X 0.095"	FT1455-NT-32	FT1355-H-40	FT1355-A-36	FT1355-T-33
1 1/4" X 0.109"	FT1455-NT-32	FT1355-H-36	FT1355-A-36	FT1355-T-33
1 1/4" X 0.120"	FT1455-NT-32	FT1355-H-36	FT1355-A-33	FT1355-T-33
1 1/2" X 0.065"-0.120"	FT1455-J-38	FT1355-H-50	FT1355-A-45	FT1355-T-40
1 1/2" X 0.134"-0.148"	FT1455-J-38	FT1355-H-45	FT1355-A-40	FT1355-T-40
2" X 0.065"-0.120"	FT1455-J-50	FT1355-H-60	FT1355-A-55	FT1355-T-50
2" X 0.134"-0.188"	FT1455-J-50	FT1355-H-55	FT1355-A-50	FT1355-T-50

Assembly equipment

Contamination control products

L

FT1455 and FT1355 series

Recommended nozzles and cleaning projectiles for tubes (metric)

Recommended nozzles and cleaning projectiles for tubes (metric)

Outside diameter x Wall thickness	Nozzle part #	Cleaning projectile part #	Abrasive projectile part #	Tube projectile part #
6 X 1.0	FT1455-NT-06x1.5	FT1355-H-07	FT1355-A-06	FT1355-T-06
6 X 1.5	FT1455-NT-06x1.5	FT1355-H-07	FT1355-A-06	-
8 X 1.0	FT1455-NT-08x1.5	FT1355-H-10	FT1355-A-07	FT1355-T-07
8 X 1.5	FT1455-NT-08x1.5	FT1355-H-10	FT1355-A-07	FT1355-T-07
10 X 1.0	FT1455-NT-10x1.5	FT1355-H-14	FT1355-A-12	FT1355-T-12
10 X 1.5	FT1455-NT-10x1.5	FT1355-H-14	FT1355-A-12	FT1355-T-12
12 X 1.0	FT1455-NT-12x2.0	FT1355-H-16	FT1355-A-14	FT1355-T-14
12 X 1.5	FT1455-NT-12x2.0	FT1355-H-16	FT1355-A-14	FT1355-T-14
12 X 2.0	FT1455-NT-12x2.0	FT1355-H-14	FT1355-A-12	FT1355-T-12
14 X 1.0	FT1455-NT-14x2.0	FT1355-H-18	FT1355-A-16	FT1355-T-16
14 X 1.5	FT1455-NT-14x2.0	FT1355-H-16	FT1355-A-14	FT1355-T-14
14 X 2.0	FT1455-NT-14x2.0	FT1355-H-16	FT1355-A-14	FT1355-T-14
15 X 1.0	FT1455-NT-15x2.0	FT1355-H-20	FT1355-A-18	FT1355-T-16
15 X 1.5	FT1455-NT-15x2.0	FT1355-H-18	FT1355-A-16	FT1355-T-16
15 X 2.0	FT1455-NT-15x2.0	FT1355-H-16	FT1355-A-14	FT1355-T-14
16 X 1.0	FT1455-NT-16x2.5	FT1355-H-22	FT1355-A-20	FT1355-T-18
16 X 1.5	FT1455-NT-16x2.5	FT1355-H-20	FT1355-A-18	FT1355-T-16
16 X 2.0	FT1455-NT-16x2.5	FT1355-H-18	FT1355-A-16	FT1355-T-16
16 X 2.5	FT1455-NT-16x2.5	FT1355-H-16	FT1355-A-14	FT1355-T-14
18 X 1.0	FT1455-NT-18x2.5	FT1355-H-24	FT1355-A-22	FT1355-T-20
18 X 1.5	FT1455-NT-18x2.5	FT1355-H-24	FT1355-A-20	FT1355-T-18
18 X 2.0	FT1455-NT-18x2.5	FT1355-H-22	FT1355-A-20	FT1355-T-18
18 X 2.5	FT1455-NT-18x2.5	FT1355-H-20	FT1355-A-18	FT1355-T-16
20 X 1.5	FT1455-NT-20x3.0	FT1355-H-26	FT1355-A-24	FT1355-T-22
20 X 2.0	FT1455-NT-20x3.0	FT1355-H-24	FT1355-A-22	FT1355-T-20
20 X2.5	FT1455-NT-20x3.0	FT1355-H-24	FT1355-A-20	FT1355-T-18
20 X 3	FT1455-NT-20x3.0	FT1355-H-22	FT1355-A-20	FT1355-T-18

Outside diameter x wall thickness	Nozzle part #	Cleaning projectile part #	Abrasive projectile part #	Tube projectile part #
22 X 1	FT1455-NT-22x2.0	FT1355-H-30	FT1355-A-28	FT1355-T-26
22 X 1.5	FT1455-NT-22x2.0	FT1355-H-30	FT1355-A-28	FT1355-T-26
22 X 2	FT1455-NT-22x2.0	FT1355-H-30	FT1355-A-28	FT1355-T-26
25 X 2	FT1455-NT-25x3.0	FT1355-H-33	FT1355-A-30	FT1355-T-28
25 X 2.5	FT1455-NT-25x3.0	FT1355-H-30	FT1355-A-28	FT1355-T-26
25 X 3	FT1455-NT-25x3.0	FT1355-H-30	FT1355-A-28	FT1355-T-26
28 X 2	FT1455-NT-28x2.5	FT1355-H-36	FT1355-A-33	FT1355-T-33
28 X 2.5	FT1455-NT-28x2.5	FT1355-H-36	FT1355-A-33	FT1355-T-30
30 X 2	FT1455-NT-30x4.0	FT1355-H-36	FT1355-A-33	FT1355-T-33
30 X 2.5	FT1455-NT-30x4.0	FT1355-H-36	FT1355-A-33	FT1355-T-30
30 X 3	FT1455-NT-30x4.0	FT1355-H-36	FT1355-A-33	FT1355-T-30
30 X 4	FT1455-NT-30x4.0	FT1355-H-36	FT1355-A-33	FT1355-T-30
35 X 2	FT1455-NT-35x3.0	FT1355-H-45	FT1355-A-40	FT1355-T-40
35 X 3	FT1455-NT-35x3.0	FT1355-H-40	FT1355-A-36	FT1355-T-36
35 X 4	FT1455-N-H25	FT1355-H-40	FT1355-A-36	FT1355-T-33
35 X 5	FT1455-N-H25	FT1355-H-36	FT1355-A-33	FT1355-T-30
38 X 2.5	FT1455-NT-38x5.0	FT1355-H-50	FT1355-A-45	FT1355-T-40
38 X 3	FT1455-NT-38x5.0	FT1355-H-50	FT1355-A-45	FT1355-T-40
38 X 4	FT1455-NT-38x5.0	FT1355-H-45	FT1355-A-40	FT1355-T-40
38 X 5	FT1455-NT-38x5.0	FT1355-H-40	FT1355-A-36	FT1355-T-36
42 X 2	FT1455-NT-42x3.0	FT1355-H-55	FT1355-A-50	FT1355-T-50
42 X 3	FT1455-NT-42x3.0	FT1355-H-50	FT1355-A-50	FT1355-T-45
50 X 3	FT1455-NT-50x5.0	FT1355-H-60	FT1355-A-55	FT1355-T-55
50 X 5	FT1455-NT-50x5.0	FT1355-H-55	FT1355-A-55	FT1355-T-50
50 X 6	FT1455-NT-50x5.0	FT1355-H-55	FT1355-A-50	FT1355-T-50

FT1355 series

Cleaning projectiles for hose, tube and pipe assemblies

FT1355 cleaning projectiles work by being compressed against the internal surface of the hose, tube or pipe. Cleaning projectile selection should favor a diameter 20% to 30% larger than the internal diameter of the hose, tube or pipe being cleaned.

Projectiles are available in 3 variations as outlined below, and are manufactured from virgin materials with a specific cell structure and density to match the application's needs. Appropriate selection of the cleaning projectile based on the type of application ensures effective cleaning.



FT1355-H-XX

Hose cleaning projectiles for hose assemblies

- Universal cleaning projectile for use with hose, tube and pipe assemblies
- Removes fine particles of loose contaminants after cutting operations
- Can also be used for product purging prior to assembly

FT1355-H-XX Cleaning projectiles for hose assemblies

Part no.	Description
FT1355-H-05	Hose cleaning projectile (05mm)
FT1355-H-06	Hose cleaning projectile (06mm)
FT1355-H-07	Hose cleaning projectile (07mm)
FT1355-H-08	Hose cleaning projectile (08mm)
FT1355-H-10	Hose cleaning projectile (10mm)
FT1355-H-12	Hose cleaning projectile (12mm)
FT1355-H-14	Hose cleaning projectile (14mm)
FT1355-H-16	Hose cleaning projectile (16mm)
FT1355-H-18	Hose cleaning projectile (18mm)
FT1355-H-20	Hose cleaning projectile (20mm)
FT1355-H-22	Hose cleaning projectile (22mm)
FT1355-H-24	Hose cleaning projectile (24mm)
FT1355-H-26	Hose cleaning projectile (26mm)
FT1355-H-28	Hose cleaning projectile (28mm)
FT1355-H-30	Hose cleaning projectile (30mm)
FT1355-H-33	Hose cleaning projectile (33mm)
FT1355-H-36	Hose cleaning projectile (36mm)
FT1355-H-40	Hose cleaning projectile (40mm)
FT1355-H-45	Hose cleaning projectile (45mm)
FT1355-H-50	Hose cleaning projectile (50mm)
FT1355-H-55	Hose cleaning projectile (55mm)
FT1355-H-60	Hose cleaning projectile (60mm)
FT1355-H-65	Hose cleaning projectile (65mm)
FT1355-H-70	Hose cleaning projectile (70mm)
FT1355-H-75	Hose cleaning projectile (75mm)
FT1355-H-80	Hose cleaning projectile (80mm)
FT1355-H-85	Hose cleaning projectile (85mm)
FT1355-H-90	Hose cleaning projectile (90mm)
FT1355-H-95	Hose cleaning projectile (95mm)
FT1355-H-100	Hose cleaning projectile (00mm)

Assembly equipment

Contamination control products

L

FT1355 series

Cleaning projectiles for tube and pipe assemblies



FT1355-A-XX

Abrasive cleaning projectiles for tube and pipe assemblies

- For use with tubes or pipe assemblies
- Removes mild to medium amounts of contaminants including surface rust and scale build-up
- Can be used multiple times

FT1355-A-XX Abrasive cleaning projectiles for tube and pipe assemblies

Part no.	Description
FT1355-A-06	Abrasive cleaning projectile (06mm)
FT1355-A-07	Abrasive cleaning projectile (07mm)
FT1355-A-10	Abrasive cleaning projectile (10mm)
FT1355-A-12	Abrasive cleaning projectile (12mm)
FT1355-A-14	Abrasive cleaning projectile (14mm)
FT1355-A-16	Abrasive cleaning projectile (16mm)
FT1355-A-18	Abrasive cleaning projectile (18mm)
FT1355-A-20	Abrasive cleaning projectile (20mm)
FT1355-A-22	Abrasive cleaning projectile (22mm)
FT1355-A-24	Abrasive cleaning projectile (24mm)
FT1355-A-26	Abrasive cleaning projectile (26mm)
FT1355-A-28	Abrasive cleaning projectile (28mm)
FT1355-A-30	Abrasive cleaning projectile (30mm)
FT1355-A-33	Abrasive cleaning projectile (33mm)
FT1355-A-36	Abrasive cleaning projectile (36mm)
FT1355-A-40	Abrasive cleaning projectile (40mm)
FT1355-A-45	Abrasive cleaning projectile (45mm)
FT1355-A-50	Abrasive cleaning projectile (50mm)
FT1355-A-55	Abrasive cleaning projectile (55mm)
FT1355-A-60	Abrasive cleaning projectile (60mm)



FT1355-T-XX

Tube cleaning projectiles for tube and pipe assemblies

- Cleaning projectiles for use with tube and pipe assemblies
- Removes mild to medium amounts of contaminants including surface rust and scale build-up
- Removes mandrel lubricants, grease and other oils typically used in bending processes
- Strongly recommended for cleaning stainless steel tubes

FT1355-T-XX Tube cleaning projectiles for tube assemblies

Part no.	Description
FT1355-T-06	Tube cleaning projectile (06mm)
FT1355-T-07	Tube cleaning projectile (07mm)
FT1355-T-10	Tube cleaning projectile (10mm)
FT1355-T-12	Tube cleaning projectile (12mm)
FT1355-T-14	Tube cleaning projectile (14mm)
FT1355-T-16	Tube cleaning projectile (16mm)
FT1355-T-18	Tube cleaning projectile (18mm)
FT1355-T-20	Tube cleaning projectile (20mm)
FT1355-T-22	Tube cleaning projectile (22mm)
FT1355-T-24	Tube cleaning projectile (24mm)
FT1355-T-26	Tube cleaning projectile (26mm)
FT1355-T-28	Tube cleaning projectile (28mm)
FT1355-T-30	Tube cleaning projectile (30mm)
FT1355-T-33	Tube cleaning projectile (33mm)
FT1355-T-36	Tube cleaning projectile (36mm)
FT1355-T-40	Tube cleaning projectile (40mm)
FT1355-T-45	Tube cleaning projectile (45mm)
FT1355-T-50	Tube cleaning projectile (50mm)
FT1355-T-55	Tube cleaning projectile (55mm)
FT1355-T-60	Tube cleaning projectile (60mm)

FT1355 series

Cleaning projectile selection ordering guidelines

Order quantity is one bag
(ex.. A 1 piece order will be for the full bag quantity noted below)

Eaton projectile part number	Description	Qty / bag	Eaton projectile part number	Description	Qty / bag	Eaton projectile part number	Description	Qty / bag
FT1355-A-06	ABRASIVE (06mm) (Pkg 100)	100	FT1355-H-12	Low density hose projectile (12mm) (Pkg 100)	100	FT1355-T-07	Tube projectile (07mm) (Pkg 100)	100
FT1355-A-07	ABRASIVE (07mm) (Pkg 100)	100	FT1355-H-14	Low density hose projectile (14mm) (Pkg 100)	100	FT1355-T-10	Tube projectile (10mm) (Pkg 100)	100
FT1355-A-10	ABRASIVE (10mm) (Pkg 100)	100	FT1355-H-16	Low density hose projectile (16mm) (Pkg 100)	100	FT1355-T-12	Tube projectile (12mm) (Pkg 100)	100
FT1355-A-12	ABRASIVE (12mm) (Pkg 100)	100	FT1355-H-18	Low density hose projectile (18mm) (Pkg 100)	100	FT1355-T-14	Tube projectile (14mm) (Pkg 100)	100
FT1355-A-14	ABRASIVE (14mm) (Pkg 100)	100	FT1355-H-20	Low density hose projectile (20mm) (Pkg 50)	50	FT1355-T-16	Tube projectile (16mm) (Pkg 100)	100
FT1355-A-16	ABRASIVE (16mm) (Pkg 100)	100	FT1355-H-22	Low density hose projectile (22mm) (Pkg 50)	50	FT1355-T-18	Tube projectile (18mm) (Pkg 100)	100
FT1355-A-18	ABRASIVE (18mm) (Pkg 100)	100	FT1355-H-24	Low density hose projectile (24mm) (Pkg 50)	50	FT1355-T-20	Tube projectile (20mm) (Pkg 50)	50
FT1355-A-20	ABRASIVE (20mm) (Pkg 50)	50	FT1355-H-26	Low density hose projectile (26mm) (Pkg 50)	50	FT1355-T-22	Tube projectile (22mm) (Pkg 50)	50
FT1355-A-22	ABRASIVE (22mm) (Pkg 50)	50	FT1355-H-28	Low density hose projectile (28mm) (Pkg 40)	40	FT1355-T-24	Tube projectile (24mm) (Pkg 50)	50
FT1355-A-24	ABRASIVE (24mm) (Pkg 50)	50	FT1355-H-30	Low density hose projectile (30mm) (Pkg 40)	40	FT1355-T-26	Tube projectile (26mm) (Pkg 50)	50
FT1355-A-26	ABRASIVE (26mm) (Pkg 50)	50	FT1355-H-33	Low density hose projectile (33mm) (Pkg 40)	40	FT1355-T-28	Tube projectile (28mm) (Pkg 40)	40
FT1355-A-28	ABRASIVE (28mm) (Pkg 40)	40	FT1355-H-36	Low density hose projectile (36mm) (Pkg 30)	30	FT1355-T-30	Tube projectile (30mm) (Pkg 40)	40
FT1355-A-30	ABRASIVE (30mm) (Pkg 40)	40	FT1355-H-40	Low density hose projectile (40mm) (Pkg 30)	30	FT1355-T-33	Tube projectile (33mm) (Pkg 40)	40
FT1355-A-33	ABRASIVE (33mm) (Pkg 40)	40	FT1355-H-45	Low density hose projectile (45mm) (Pkg 20)	20	FT1355-T-36	Tube projectile (36mm) (Pkg 30)	30
FT1355-A-36	ABRASIVE (36mm) (Pkg 30)	30	FT1355-H-50	Low density hose projectile (50mm) (Pkg 20)	20	FT1355-T-40	Tube projectile (40mm) (Pkg 30)	30
FT1355-A-40	ABRASIVE (40mm) (Pkg 30)	30	FT1355-H-55	Low density hose projectile (55mm) (Pkg 15)	15	FT1355-T-45	Tube projectile (45mm) (Pkg 20)	20
FT1355-A-45	ABRASIVE (45mm) (Pkg 20)	20	FT1355-H-60	Low density hose projectile (55mm) (Pkg 15)	15	FT1355-T-50	Tube projectile (50mm) (Pkg 20)	20
FT1355-A-50	ABRASIVE (50mm) (Pkg 20)	20	FT1355-H-65	Low density hose projectile (60mm) (Pkg 15)	15	FT1355-T-55	Tube projectile (55mm) (Pkg 15)	15
FT1355-A-55	ABRASIVE (55mm) (Pkg 15)	15	FT1355-H-70	Low density hose projectile (65mm) (Pkg 10)	10	FT1355-T-60	Tube projectile (60mm) (Pkg 15)	15
FT1355-A-60	ABRASIVE (60mm) (Pkg 15)	15	FT1355-H-75	Low density hose projectile (70mm) (Pkg 10)	10			
FT1355-H-05	Low density hose projectile (05mm) (Pkg 100)	100	FT1355-H-80	Low density hose projectile (80mm) (Pkg 10)	10			
FT1355-H-06	Low density hose projectile (06mm) (Pkg 100)	100	FT1355-H-85	Low density hose projectile (85mm) (Pkg 10)	10			
FT1355-H-07	Low density hose projectile (07mm) (Pkg 100)	100	FT1355-H-90	Low density hose projectile (90mm) (Pkg 10)	10			
FT1355-H-08	Low density hose projectile (08mm) (Pkg 100)	100	FT1355-H-95	Low density hose projectile (95mm) (Pkg 10)	10			
FT1355-H-10	Low density hose projectile (10mm) (Pkg 100)	100	FT1355-H-100	Low density hose projectile (100mm) (Pkg 10)	10			
FT1355-H-100	Low density hose projectile (100mm) (Pkg 100)	100	FT1355-T-06	Tube projectile (06mm) (Pkg 100)	100			

Assembly equipment

Contamination control products

L

FT1355 series

Cleaning projectile selection ordering guidelines

Order quantity is one bag
(ex. A 1 piece order will be for the full bag quantity noted below)

FT1355 foam projectile part #’ s for FT1455 projectile launchers	Order quantity is one bag .(ex.. A 1 piece order will be for the full bag quantity noted below)	Inner Diameter (ID) in inches of cut hose, and Hose assembly Dash size
FT1355-H-06	100	3/16" (-03)
FT1355-H-10 (or)	100	1/4" (-04)
FT1355-H-12*	100	
FT1355-H-12 (or)	100	
FT1355-H-14*	100	5/16" (-05)
FT1355-H-14 (or)	100	
FT1355-H-16*	100	3/8" (-06)
FT1355-H-18 (or)	100	
FT1355-H-20*	50	1/2" (-08)
FT1355-H-22	50	5/8" (-10)
FT1355-H-26	50	3/4" (-12)

FT1355 foam projectile part #’ s for FT1455 projectile launchers	Order quantity is one bag .(ex.. A 1 piece order will be for the full bag quantity noted below)	Inner Diameter (ID) in inches of cut hose, and Hose assembly Dash size
FT1355-H-33 (or)	40	1" (-16)
FT1355-H-36*	30	
FT1355-H-40	30	1 1/4" (-20)
FT1355-H-45*	20	
FT1355-H-50 (or)	20	1 1/2" (-24)
FT1355-H-55*	15	
FT1355-H-60 (or)	15	2" (-32)
FT1355-H-65*	10	
FT1355-H-75	10	2 1/2" (-40)
FT1355-H-85	10	3" (-48)
FT1355-H-100	10	3 1/2" (-64)

Note: * Use the larger projectile size for maximum cleaning on hose cut with an abrasive wheel

FT1555 CapSeal system



FT1555 series CapSeal system

The FT1555 CapSeal system is intended to be used in conjunction with the FT1355 and FT1455 series projectile cleaning systems to prevent recontamination of hose, tube, and pipe assemblies. The FT1555 CapSeal system utilizes heat shrink technology to encapsulate the end of a hose or tube assembly with an FT1555 CapSeal capsule.

Features

- Provides industry leading ISO cleanliness levels
- Robust construction for use in heavy duty applications
- Available in hand-held and bench-mount configurations
- Ideal for portable small volume applications, and large volume production applications
- Optimum CapSeal capsule design to meet a broad variety of applications
- Minimal setup
- Capability: 1/4" to 2" ID hose and fitting ends
- Available in kits or individual replacement hardware components
- Kits available with and without projectiles

Typical applications

Hydraulics	<ul style="list-style-type: none"> • Removes rubber dust and metal particles from the hydraulic hose cutting process • Removes metal flash from the crimping process on hose and tubes • Removal of contaminated oil from hoses, tubes and pipes in hydraulic systems
Pneumatics	<ul style="list-style-type: none"> • Eliminates rubber contamination, metal particles, contaminated oil and moisture that causes breakdowns and inefficiency
Heat exchangers and condenser	<ul style="list-style-type: none"> • Eliminates contamination that reduces heat transfer resulting in low level performance
Steam boilers	<ul style="list-style-type: none"> • Removes most scaling in steam pipes for maintenance servicing
Air conditioning and refrigeration	<ul style="list-style-type: none"> • Eliminates minute particles in copper tubes and coolant lines that affect system performance
Oxygen and gas	<ul style="list-style-type: none"> • Eliminates oil, grease and other contaminants from copper or S/S tubing
Oil, gas and chemical processing	<ul style="list-style-type: none"> • Efficient cleaning of pipes as part of service maintenance
Earthmoving equipment	<ul style="list-style-type: none"> • Maintenance reduction in flushing time and filter usage
Automotive and servicing	<ul style="list-style-type: none"> • Cleaning of fuel lines and brake lines prior to assembly and servicing of components
Food and beverage	<ul style="list-style-type: none"> • Product recovery retrieval of product from lines. Reducing or eliminating solvents or detergents
Gun barrels	<ul style="list-style-type: none"> • To remove rust, scale or powder residue much faster than brushing or swabbing

Assembly equipment

Contamination control products

L

FT1555 CapSeal system

Hardware

FT1555-HH



Hand held electric heat gun

- Variable temperature electronic heat gun with electronic thermocouple control
- Duratherm heating element ensure long life and even heat temperature range of 120°F (49°C) to 1100°F (593°C) and a built-in cool down switch
- Case not included
- Capable of sealing multiple hoses simultaneously
- Additional nozzle attachments included for other heat shrinking applications
- Operates on 120V AC power, draws 1500 watts, and can produce 17.6CFM

FT1555-BM



Bench mount production heat shrink machine

- Industrial production ready - brushless heat source with robust thermal insulation for 24/7 continuous operation capability
- Enables sealing of single or multiple hose or tube assemblies at one time
- White plunger provides solid surface for holding CapSeal capsules for uniform heat distribution during heat shrinking
- Dedicated air filter prevents airborne contamination during sealing
- Hot air blower timer allows for optimum cycle time depending on hose or tube ends being sealed
- Accepts CapSeal capsules from 3/4" (20mm) ID to 3" (80mm) ID and allows sealing and thread protection for most hose and tube ends from -4 (1/4") through -32 (2")
- Operates on 230V single-phase AC power at 50/60Hz and draws < 10 amps
- Please note that a L6-15 NEMA twist loc receptacle (not supplied) is required for operation

FT1555 CapSeal system Kits

FT1555-HH-K1



Hand held electric heat gun basic kit (up to 1-1/2" hose ID and tube ends)

- Capability – for use with 1/8" through 1-1/2" hose ID or tube ends
- Form factor – Hand-held, portable – ideal for harsh environments and heavy use
- Typical applications – Mobile hose fabricators and mobile applications
- Case not included

FT1555-HH-K1 kit includes

- FT1555-HH hand held electric heat gun
- FT1555-HH-ST flex vacuum pump stand for hand held electric heat gun
- FT1555-HH-D15 1-1/2" diffuser for hand held electric heat gun

FT1555-HH-K2



Hand held electric heat gun starter kit (up to 1-1/2" hose ID and tube ends)

- Capability – For use with 1/8" through 1-1/2" hose ID or tube ends
- Form factor – Hand-held, portable – ideal for harsh environments and heavy use
- Typical applications – Mobile hose fabricators and mobile applications
- Case not included

FT1555-HH-K2 kit includes in addition to contents of FT1555-HH-K1 kit

- FT1555-2540UP CapSeal Capsules 25mm x 40mm (ID x LENGTH)
- FT1555-2840UP CapSeal Capsules 28mm x 40mm (ID x LENGTH)
- FT1555-3140UP CapSeal Capsules 31mm x 40mm (ID x LENGTH)
- FT1555-3440UP CapSeal Capsules 34mm x 40mm (ID x LENGTH)
- FT1555-3840UP CapSeal Capsules 38mm x 40mm (ID x LENGTH)
- FT1555-4650UP CapSeal Capsules 46mm x 50mm (ID x LENGTH)

FT1555-HH-K3



Hand held electric heat gun premium starter kit (up to 1-1/2" hose ID and tube ends)

- Capability – For use with 1/8" through 1-1/2" hose ID or tube ends
- Form factor – Hand-held, portable – ideal for harsh environments and heavy use
- Typical applications – Mobile hose fabricators and mobile applications
- Case not included

FT1555-HH-K3 kit includes in addition to contents of FT1555-HH-K1 kit

- FT1555-2023UP CapSeal Capsules 20mm x 23mm (ID x LENGTH)
- FT1555-2540UP CapSeal Capsules 25mm x 40mm (ID x LENGTH)
- FT1555-2840UP CapSeal Capsules 28mm x 40mm (ID x LENGTH)
- FT1555-3140UP CapSeal Capsules 31mm x 40mm (ID x LENGTH)
- FT1555-3440UP CapSeal Capsules 34mm x 40mm (ID x LENGTH)
- FT1555-3840UP CapSeal Capsules 38mm x 40mm (ID x LENGTH)
- FT1555-4650UP CapSeal Capsules 46mm x 50mm (ID x LENGTH)
- FT1555-5260UP CapSeal Capsules 52mm x 60mm (ID x LENGTH)
- FT1555-5860UP CapSeal Capsules 58mm x 60mm (ID x LENGTH)
- FT1555-6760UP CapSeal Capsules 67mm x 60mm (ID x LENGTH)
- FT1555-8060UP CapSeal Capsules 80mm x 60mm (ID x LENGTH)

Assembly equipment

Contamination control products

L

FT1555 CapSeal system

Capsules

FT1555 CapSeal capsules eliminate contamination by forming a clean and secure seal around hose and tube ends. FT1555 CapSeal system eliminates the need to stock multiple plastic threaded caps with just 16 CapSeal capsule sizes to meet all type of hose and tube end configurations.

Additionally, the quick and easy pull-off tab on each capsule eliminates the need for additional tools that could further contaminate the assemblies.

FT1555 CapSeal capsules are available in 16 sizes of varying diameter and length to match needs of all assemblies, and are available in both unit packaged and bulk packaged packaging.

Unit packaged CapSeal packages		Bulk packaged CapSeal packages		CapSeal capsule size		Hex sizes covered		Fitting	
CapSeal part #	Packaged quantity	CapSeal part #	Packaged quantity	(mm, ID X length)	(mm)	(Inches)	Straight	Elbow*	
FT1555-2023UP	810	FT1555-2023BP	23,400	20 X 23	12mm to 18mm	0.47" to 0.71"		X	
FT1555-2030UP	810	FT1555-2030BP	23,400	20 X 30	12mm to 18mm	0.47" to 0.71"	X		
FT1555-2224UP	810	FT1555-2224BP	22,500	22 X 24	16mm to 21mm	0.63" to 0.63"		X	
FT1555-2527UP	800	FT1555-2527BP	17,600	25 X 27	18mm to 23mm	0.71" to 0.91"		X	
FT1555-2540UP	800	FT1555-2540BP	17,600	25 X 40	18mm to 23mm	0.71" to 0.91"	X		
FT1555-2840UP	720	FT1555-2840BP	15,200	28 X 40	22mm to 26mm	0.87" to 1.02"	X		
FT1555-3133UP	640	FT1555-3133BP	12,240	31 X 33	24mm to 29mm	0.94" to 1.14"		X	
FT1555-3140UP	640	FT1555-3140BP	12,240	31 X 40	24mm to 29mm	0.95" to 1.14"	X		
FT1555-3440UP	640	FT1555-3440BP	10,240	34 X 40	27mm to 32mm	1.07" to 1.26"	X		
FT1555-3840UP	560	FT1555-3840BP	7,800	38 X 40	30mm to 36mm	1.19" to 1.42"	X	X	
FT1555-4345UP	480	FT1555-4345BP	6,240	43 X 45	32mm to 41mm	1.26" to 1.61"	X	X	
FT1555-4650UP	480	FT1555-4650BP	5,760	46 X 50	34mm to 44mm	1.34" to 1.73"	X	X	
FT1555-5260UP	400	FT1555-5260BP	4,400	52 X 60	41mm to 50mm	1.62" to 1.97"	X	X	
FT1555-5860UP	400	FT1555-5860BP	3,600	58 X 60	49mm to 56mm	1.93" to 2.20"	X	X	
FT1555-6760UP	320	FT1555-6760BP	2,560	67 X 60	55mm to 65mm	2.16" to 2.56"	X	X	
FT1555-8060UP	320	FT1555-8060BP	1,736	80 X 60	64mm to 78mm	2.52" to 3.07"	X	X	

* Shorter length CapSeal capsules are recommended for elbow and angled fittings (45° and 90°)

FT1555 CapSeal system

Accessories



FT1555-HH-D15

1-1/2" Diffuser for FT1555-HH hand held electric heat gun

- Even 360° heat diffusion to shrink CapSeal capsules fitting configurations
- Accommodates all CapSeal capsules up to 1-1/2"



FT1555-HH-ST

Flexible stand for FT1555-HH hand held electric heat gun

- Convenient carrying case to store and carry the hand held projectile launchers and relevant nozzles
- Works with all 3 models of hand held projectile launchers



FT1555-HH-D20

2" Diffuser for FT1555-HH hand held electric heat gun

- Even 360° heat diffusion to shrink CapSeal capsules
- Accommodates all CapSeal capsules up to 2"
- Stainless steel construction for superior service life



E-EQCR-TT006-E

Operating Instructions for FT1555-BM Bench Mount Capping Machine

Glossary and index

Glossary M-2
Index M-6



A

abrasion: external damage to a hose assembly caused by its being rubbed on a foreign object; a wearing away by friction.

ABS: Air-Brake Swivel absorption: regarding hose, the process of taking in fluid. Hose materials are often compared with regard to relative rates and total amounts of absorption as they pertain to specific fluids.

acid resistant: having the ability to withstand the action of identified acids within specified limits of concentration and temperature

adapter, adaptor: **1)** fittings of various sizes and materials used to change an end fitting from one type to another type or one size to another. (i.e., a male SAE to male pipe adapter is often attached to a female SAE to create a male end union fitting); **2)** the grooved portion of a cam & groove coupling.

adhesion: the strength of bond between cured rubber surfaces or between a cured rubber surface and a non-rubber surface.

adhesive: a material which, when applied, will cause two surfaces to adhere.

ambient temperature: the temperature of the atmosphere or medium surrounding an object under consideration.

ambient/atmospheric conditions: The surrounding conditions, such as temperature, pressure, and corrosion, to which a hose assembly is exposed.

amplitude of vibrations and/or lateral movement: the distance a hose assembly deflects laterally to one side from its normal position, when this deflection occurs on both sides of the normal hose centerline.

anchor: a restraint applied to eliminate motion and restrain forces.

annular: refers to the convolutions on a hose that are a series of complete

circles or rings located at right angles to the longitudinal axis of the hose (sometimes referred to as “bellows”).

anodize, anodized: an electrolytic process used to deposit protective or cosmetic coatings in a variety of colors on metal; primarily used with aluminum.

ANSI: American National Standards Institute.

application working pressure: unique to customer’s application. See pressure, working.

application: the service conditions that determine how a hose assembly will be used.

armor: a protective cover slid over and affixed to a hose assembly; used to prevent over bending or for the purpose of protecting hose from severe external environmental conditions such as hot materials, abrasion, or traffic.

assembly: a general term referring to any hose coupled with end fittings of any style attached to one or both ends.

ASTM: American Society for Testing and Materials.

attachment: the method of securing an end fitting to a hose (e.g., banding, crimping, swaging, or screw-together 2 piece or 3 piece-style field attachable fittings).

axial movement: compression or elongation along the longitudinal axis.

B

backing: a soft rubber layer between a hose tube and/or cover and carcass to provide adhesion.

barb: the portion of a fitting (coupling) that is inserted into the hose, usually comprised of two or more radial serrations or ridges designed to form a redundant seal between the hose and fitting.

barbed and ferrule fitting: a two-piece hose fitting comprised of a barbed insert (nipple), normally with peripheral ridges or backward-slanted barbs, for inserting into a hose and a ferrule; usually crimped or swaged.

Barb-Tite: a line of low pressure push-on brass hose end fittings that is a trademark of Eaton Corporation.

bend radius: the radius of a bent section of hose measured to the innermost surface of the curved portion.

bend radius, minimum: the smallest radius at which a hose can be used. For metal hose: the radius of a bend measured to the hose centerline, as recommended by the manufacturer.

blister: a raised area on the surface or a separation between layers usually creating a void or air-filled space in a vulcanized article.

blow out force: the force generated from the internal pressure attempting to push the fitting from the hose.

body wire: normally a round or flat wire helix embedded in the hose wall to increase strength or to resist collapse.

bore: **1)** an internal cylindrical passageway, as of a tube, hose or pipe; **2)** the internal diameter of a tube, hose, or pipe.

braid: the woven portion of a hose used as reinforcement to increase pressure rating and add hoop strength. Various materials such as polyester, cotton or metal wire are used. A hose may have one or more braids, outside or between layers of hose material.

braid wear: motion between the braid and corrugated hose, which normally causes wear on the outside diameter of the corrugation and the inside diameter of the braid.

braided ply: a layer of braided reinforcement.

braid-over-braid: multiple plies of braid having no separating layers.

brand: a mark or symbol identifying or describing a product and/or manufacturer, that is embossed, inlaid or printed.

brass: a family of copper/zinc alloys.

brazing: a process of joining metals using a non-ferrous filler metal having a melting point that is lower than

the “parent metals” to be joined, typically over +800°F (+427°C).

bronze: an alloy of copper, tin and zinc.

BSPP/BSPT: British Standard Pipe Parallel / British Standard Pipe Tapered. See fitting/coupling — pipe thread fittings.

C

carcass: the fabric, cord and/or metal reinforcing section of a hose as distinguished from the hose tube or cover.

chalking: the formation of a powdery surface condition due to disintegration of surface binder or elastomer by weathering or other destructive environments.

checking: the short, shallow cracks on the surface of a rubber product resulting from damaging action of environmental conditions.

chemical compatibility: the relative degree to which a material may contact another without corrosion, degradation or adverse change of properties.

chemical resistance: the ability of a particular polymer, rubber compound, or metal to exhibit minimal physical and/or chemical property changes when in contact with one or more chemicals for a specified length of time, at specified concentrations, pressure, and temperature.

cold flexibility: relative ease of bending while being exposed to specified low temperature.

collar: **1)** the portion of a fitting that is compressed by crimping to seal the hose onto the fitting barbs and create a permanent attachment; also called a ferrule. (With field attachable fittings, the lock and seal are accomplished mechanically by the collar without crimping); **2)** a raised portion on the hose shank which functions as a connection for a ferrule or other locking device or functions as a hose stop.

collet: a tool or die-set used to crimp a hose end fitting onto a hose. A crimping die-

set is typically six to eight “fingers” designed for infinite diameter settings within a range or preset to a specific diameter for a given hose type and size. Some may have a replaceable cage.

Coll-O-Crimp: a line of hydraulic and pneumatic hose, hose end fittings, and fabrication equipment that is a registered trademark of Eaton Corporation.

combustible liquid: a liquid having a flash point at or above +100°F (+37.8°C).

compound: the mixture of rubber or plastic and other materials, which are combined to give the desired properties when used in the manufacture of a product.

compression fitting: see fitting/coupling – compression

conductive: the ability to transfer electrical potential.

configuration: the combination of fittings on a particular assembly.

convoluted: description of hose or innercore having annular or helical ridges formed to enhance flexibility.

core: the inner portion of a hose, usually referring to the material in contact with the medium.

corrosion: the process of material degradation by chemical or electrochemical means.

corrosion resistance: ability of metal components to resist oxidation.

corrugated hose: hose with a carcass fluted, radially or helically, to enhance its flexibility or reduce its weight.

coupling: a frequently used alternative term for hose end fitting.

cover: the outer component usually intended to protect the carcass of a product.

CPE: chlorinated polyethylene, a rubber elastomer.

cracking: a sharp break or fissure in the surface, generally caused by strain and environmental conditions.

crimp diameter: the distance across opposite flats after crimping.

crimp/crimping: a hose end fitting attachment method utilizing a number of dies mounted in a radial configuration. The dies close perpendicular to the hose and fitting axis, compressing the collar, ferrule, or sleeve around the hose.

cure: the act of vulcanization. See vulcanization.

cut off factor: the hose length to be subtracted from the overall assembly length that allows for the hose coupling end connection extension beyond the end of the hose.

D

date code: any combination of numbers, letters, symbols or other methods used by a manufacturer to identify the time of manufacture of a product.

deburr: to remove ragged edges from the inside diameter of a hose end.

design factor: a ratio used to establish the working pressure of the hose, based on the burst strength of the hose.

displacement: the amount of motion applied to a hose defined as inches for parallel offset and degrees for angular misalignment.

DOT: Department of Transportation.

DIN: Deutsche Industrie Norme.

duplex assembly: an assembly consisting of two hose assemblies, one inside the other, and connected at the ends; also known as “jacketed assemblies.”

durometer: an instrument for measuring the hardness of rubber and plastic compounds.

E

eccentricity: the condition resulting from the inside and outside diameters not having a common center.

effusion: the escape, usually of gases, through a material. See permeation.

elastic limit: the limiting extent to which a body may be deformed and yet return to its original shape after removal of the deforming force.

elastomer: any one of a group of polymeric materials, usually designated thermoset, such as natural rubber, or thermoplastic, which will soften with application of heat.

elongation: the increase in length expressed numerically as a percentage of the initial length.

EN: European Normes

ERMETO: a steel fitting product trademarked by Eaton Corporation.

endurance test: a service or laboratory test, conducted to product failure, usually under normal use conditions.

EPDM: Ethylene Propylene Diene Monomer; an elastomer.

extrude/extruded/extrusion: forced through the shaping die of an extruder; extrusion may have a solid or hollow cross section.

F

fabric impression: impression formed on the rubber surface during vulcanization by contact with fabric jacket or wrapper.

fabricator: the producer of hose assemblies.

fatigue: the weakening or deterioration of a material occurring when a repetitious or continuous application of stress causes strain, which could lead to failure.

FDA: United States Food and Drug Administration.

fire sleeve: slip-on or integrally extruded sleeve used to retard the effects of fire in certain applications; most often made with silicone and/or ceramic fiber.

fitting/coupling: a device attached to the end of the hose to facilitate connection. The following is only a partial list of types of fittings available.

- **banjo fitting:** a through bolted designed featuring a hollow circle or “donut” attached to one end of the fitting barb so that the inner diameter is along the hose axis.

- **compression fitting:** a fitting style that seals on a mating tube by compressing an internal ferrule against the tube O.D.

- **field attachable fitting:** a fitting designed to be attached to hose without crimping or swaging. This fitting is not always a reusable type fitting.

- **flange style fittings:** pipe flanges and flanged fitting standards are listed under ANSI B16.5. Flanges are rated for pressure and listed as “American Class 150, 300, 400, 600, 900, 1,500 or 2,500.” Pressure-temperature ratings can be obtained by consulting the ANSI specification or ASME B16.5 (American Society of Mechanical Engineers). Designs vary by neck and face style, or other dimensional changes based on use. Various finishes or grooves may be applied to the face for sealing on a gasket or o-ring. Bolt holes and other dimensions are per the ANSI standard.

- **inverted flare fitting:** a fitting consisting of a male or female nut, trapped on a tube by flaring the end of the tube material to either 37° or 45°.

- **JIC fittings:** Joint Industrial Council (no longer in existence). An engineering group that established an industry standard fitting design incorporating a 37° mating surface, male and female styles. These standards are now governed by SAE.

- **o-ring fittings:** a fitting that seals by means of an elastomeric ring of a specified material.

pipe thread fittings:

- **NPT:** National Pipe Taper. Pipe thread per ANSI B1.20.1

- **NPTF:** National Pipe Tapered for Fuels. (Same as above except dry-seal per ANSI B1.20.3)
 - **NPSH:** National Pipe Straight Hose per ANSI B1.20.7
 - **NPSM:** National Pipe Straight Mechanical. Straight thread per ANSI B1.20.1
 - **NPSL:** National Pipe Straight Loosefit per ANSI B1.20.1
 - **BSPP, BSPT:** British Standard Pipe Parallel, British Standard Pipe Taper. BS21-
 - **quick connect fitting:** a fitting designed to quickly connect and disconnect. These fittings come in many styles and types.
 - **split flange fitting:** a fitting consisting of a flange retainer and a flange of two halves. This design allows the flanges to be installed after the retainer has been attached to the hose, making the flange reusable. SAE code 61 and 62.
 - **tube fitting:** a hose fitting of which the mating end conforms to a tube diameter. The mate or male end of a compression fitting.
- flammable gases/liquid/media:** a flammable gas, including liquefied gas, is one having a closed cup flash point below +100°F (+37.8°C) and a vapor pressure greater than 25 psi (174.2 KPa).
- flex cracking:** a surface cracking induced by repeated bending and straightening.
- flow rate:** a volume of media being conveyed in a given time period.
- fluid:** a gas or liquid medium.
- fluorocarbon:** an organic compound containing fluorine directly bonded to carbon. The ability of the carbon atom to form a large variety of structural chains gives rise to many fluorocarbons and fluorocarbon derivatives.
- FOR-SEAL:** a product name for a hose end configuration using an o-ring sealing method, trademarked by Eaton Corporation.

G

gpm: gallons per minute.

H

heat resistance: the property or ability to resist the deteriorating effects of elevated temperatures.

helix: a shape formed by spiraling a wire or other reinforcement around the cylindrical body of a hose; typically used in suction hose.

hose: a flexible conduit consisting of a tube, reinforcement, and usually an outer cover.

hydrostatic testing: the use of liquid pressure to test a hose or hose assembly for leakage, twisting, and/or hose change-in-length.

Hytrell: registered trademark of Chemours.

I

I.D.: inside diameter.

identification yarn: a yarn of single or multiple colors, usually embedded in the hose wall, used to identify the manufacturer.

impression: a design formed during vulcanization in the surface of a hose by a method of transfer, such as fabric impression or molded impression.

impulse: an application of force in a manner to produce sudden strain or motion, such as hydraulic pressure applied in a hose.

innertube: the innermost layer of a hose; the hose material in contact with the medium.

insert: optional term for nipple. See nipple.

interlocking clamp: a clamp which engages the fitting in a manner which prevents the clamp from sliding off the fitting, typically a bolt or U-bolt style with interlocking fingers which engage an interlock ring on the fitting.

interlocking ferrule: a ferrule, which physically attaches to the fitting preventing the ferrule from sliding off the fitting.

ISO: International Organization for Standardization.

J

jacket: a seamless tubular braided or woven ply generally on the outside of a hose.

JIC: see fitting/coupling—JIC.

K

kinking: a temporary or permanent distortion of the hose induced by bending beyond the minimum bend radius.

L

layline: the line of printed information that runs parallel on the side of a manufactured hose giving details such as part number, psi rating, hose size, and manufacturing data.

layer: a single thickness of rubber or fabric between adjacent parts.

loop installation: the assembly is installed in a loop or “U” shape, and is most often used when frequent and/or large amounts of motion are involved.

LPG, LP Gas: liquefied petroleum gas.

M

MAWP: see pressure, maximum allowable working.

mandrel built: a hose fabricated and/or vulcanized on a mandrel.

manufacturer's identification: a code symbol used on or in some hose to indicate the manufacturer.

media, medium: the substance(s) being conveyed through a system.

N

NAHAD: National Association of Hose & Accessories Distributors.

Neoprene: a registered trademark of Chemours.

nipple: the internal member or portion of a hose fitting.

nitrile rubber (NB/Buna-N): a family of acrylonitrile elastomers used extensively for industrial hose.

nominal: a size indicator for reference only.

nomograph: a chart used to compare hose size to flow rate to recommended velocity.

non-conductive: the inability to transfer an electrical charge.

NPT/NPTF: national pipe threads. See fitting/coupling — pipe thread fittings.

nylon: a family of polyamide materials.

O

OAL: see overall length

O.D.: outside diameter.

OE/OEM: original equipment manufacturer.

oil resistance: the ability of the materials to withstand exposure to oil.

oil swell: the change in volume of a rubber article resulting from contact with oil.

operating conditions: the pressure, temperature, motion, and environment to which a hose assembly is subjected.

o-ring fitting: see fitting/coupling—o-ring.

overall length (OAL): the total length of a hose assembly, which consists of the free hose length plus the length of the coupling(s).

oxidation: the reaction of oxygen on a material, usually evidenced by a change in the appearance or feel of the surface or by a change in physical properties.

ozone cracking: the surface cracks, checks, or crazing caused by exposure to an atmosphere containing ozone.

ozone resistance: the ability to withstand the deteriorating effects of ozone (generally cracking).

P

permanent fitting: the type of fitting which, once installed, may not be removed for re-use.

permeation: the process of migration of a substance into and through another, usually the movement of a gas into and through a hose material; the rate of permeation is specific to the substance, temperature, pressure, and the material being permeated.

pin pricked: perforations through the cover of a hose to vent permeating gases.

pitch: **1)** the distance from one point on a helix to the corresponding point on the next turn of the helix, measured parallel to the axis; **2)** the distance between the two peaks of adjacent corrugation or convolution.

plating: a material, usually metal, applied to another metal by electroplating, for the purpose of reducing corrosion; typically a more noble metal such as zinc is applied to steel.

ply: an individual layer in hose construction.

polymer: a macromolecular material formed by the chemical combination of monomers, having either the same or different chemical compositions.

pressure: force ÷ unit area. For purposes of this document, refers to PSIG (pounds per square inch gauge).

pressure drop: the measure of pressure reduction or loss over a specific length of hose.

pressure, burst: the pressure at which rupture occurs.

pressure, maximum allowable working: the maximum pressure at which a hose or hose assembly is designed to be used. Abbreviated as MAWP.

pressure, working: the maximum pressure to which a hose will be subjected, including the momentary surges in pressure, which can occur during service. Abbreviated as WP.

psi: pounds per square inch.

PVC: polyvinyl chloride. A low cost thermoplastic material typically used in the manufacture of industrial hoses. The operating temperature range is -500°F to +1750°F (-295.5°C to +954.4°C).

R

reinforcement: the strengthening members, consisting of either fabric, cord, and/or metal, of a hose. See ply.

reusable fitting/coupling: see fitting/coupling—field attachable fittings.

RhinoHide: an abrasion resistant covered hydraulic hose that is a registered trademark of Eaton Corporation.

RMA: The Rubber Manufacturers Association, Inc.

S

SAE: Society of Automotive Engineers.

shank: that portion of a fitting, which is inserted into the bore of a hose.

skive: the removal of a short length of cover and/or tube to permit the attachment of a fitting directly over the hose reinforcement.

sleeve: a metal cylinder, which is not physically attached to the fitting, for the purpose of forcing the hose into the serrations of the fitting.

smooth bore: a term used to describe the type of innercore in a hose.

specification: a document setting forth pertinent details of a product.

spiral: a method of applying reinforcement in which there is not interlacing between individual strands of the reinforcement.

spring guard: a helically wound component applied internally or externally to a hose assembly, used for strain relief, abrasion resistance, collapse resistance.

standard: a document, or an object for physical comparison, for defining product characteristics, products, or processes, prepared by a consensus of a properly constituted group of those substantially affected and having the qualifications to prepare the standard for use.

static wire: wire incorporated in a hose to conduct static electricity.

stem: see nipple.

Sub-Zero: a low temperature resistant hose that is a registered trademark of Eaton Corporation.

surge (spike): a rapid and transient rise in pressure.

swelling: an increase in volume or linear dimension of a specimen immersed in liquid or exposed to a vapor.

T

Thick-Flange: a hose end fitting that is trademarked by Eaton Corporation.

tube: the innermost continuous all-rubber or plastic element of a hose.

tube fitting: see fitting/coupling—tube.

tubing: a non-reinforced, homogeneous conduit, generally of circular cross-section.

V

vacuum resistance: the measure of a hoses ability to resist negative gauge pressure.

vibration: amplitude motion occurring at a given frequency.

viscosity: the resistance of a material to flow.

W

weathering: the surface deterioration of a hose cover during outdoor exposure, as shown by checking, cracking, crazing and chalking.

wire reinforced: a hose containing wires to give added strength, increased dimensional stability and crush resistance. See reinforcement.

working temperature: the temperature range of the application; may include the temperature of the fluid conveyed or the environmental conditions the assembly is exposed to in use.

WP: working pressure.

Index

Part number index

M

Part number	page	Part number	page	Part number	page	Part number	page
7.001	I-52	2027	J-67	2244	J-58	4790	I-32
7.002	I-16	2028	J-59	2246	J-64	4797	I-49
7.005	I-35	2029	J-61	2247	J-42	8000	G-9
7.006	I-52	2030	J-60	2249	J-57	8500	G-9
7.013	I-35	2031	J-61	2250	J-57	22012	I-66
7.02	I-34	2033	J-73	2251	J-44	22012	H-92
7.021	I-52	2039	J-71	2252	J-45	22033	I-66
7.024	I-15	2040	J-40	2253	J-48	22033	H-92
7.036	I-15	2041	J-68	2254	J-48	22046	I-66
7.078	I-35	2042	J-70	2255	J-48	22046	H-89
7.122	I-53	2043	J-71	2256	J-47	22046	H-92
7.155	I-16	2044	J-53	2257	J-47	22068	I-66
7.327	I-36	2045	J-41	2266	J-77	22068	H-92
7.357	I-36	2046	J-41	2570	F-14	22546	I-64
7.39	I-53	2047	J-46	2580	C-8	22546	I-66
7.42	I-34	2048	J-45	2583	C-7	22546	H-90
7.721	I-36	2049	J-43	2651	C-10	22546	H-92
15.063	J-95	2050	J-42	2661	B-43	22617	I-66
15.117	J-96	2056	J-75	2681	B-29	22617	H-92
15.147	J-95	2060	J-75	2781	B-30	71416	J-90
15.163	J-96	2061	J-78	2807	G-8	71418	J-89
15.164	J-96	2062	J-79	3130	B-44, B-52	71422	J-90
15.165	J-97	2063	J-99	3740	B-45	73014	J-91
401	I-13	2066	J-64	4294	F-9	73056	J-67
403	I-10	2067	J-65	4297	F-10	190000	I-12
406	I-13	2068	J-66	4401	I-13	190111	I-10
411	I-14	2070	J-70	4402	I-12	190235	I-5
412	I-4	2071	J-71	4411	I-14	190260	I-7
458	I-56	2080	J-49	4412	I-4	190261	I-11
624	K-3	2081	J-39	4414	I-12	190263	I-29
1290	J-93	2082	J-40	4624	J-89	190264	I-29
1503	C-9	2083	J-38	4720	I-30	190265	I-11
1531	F-15	2084	J-39	4721	I-26	190276	I-10
1562	L-22	2085	J-43	4722	I-26	190277	I-9
1597	L-22	2087	J-46	4725	I-27	190287	I-28
1598	L-22	2088	J-43	4738	I-48	190295	I-7
1599	L-22	2089	J-44	4739	I-49	190296	I-11
2000	J-62	2090	J-49	4740	I-49	190297	I-11
2001	J-62	2091	J-48	4741	I-49	190299	I-11
2002	J-63	2092	J-47	4742	I-49	190301	I-7
2003	J-63	2093	J-47	4743	I-50	190302	I-11
2004	J-94	2096	J-42	4744	I-29	190325	I-5
2007	J-63	2215	J-69	4745	I-31	190326	I-51
2015	J-38	2216	J-65	4750	I-50	190327	I-51
2018	J-52	2220	J-36	4753	I-48	190328	I-51
2020	J-75	2222	J-40	4767	I-31	190350	I-5
2021	J-50	2229	J-37	4772	I-50	190371	I-5
2022	J-53	2239	J-52	4775	I-7	190414	I-30
2023	J-54	2240	J-51	4776	I-8	190463	I-13
2024	J-55	2242	J-52	4777	I-8	190464	I-27
2025	J-58	2243	J-54	4779	I-9	190465	I-51

Part number	page	Part number	page	Part number	page	Part number	page
190516	I-51	210212	J-75	1AA*FJA*	H-11	1BA*FJB*	H-12
190604	I-54	210292	J-69	1AA*FJB*	H-12	1BA*FJC*	H-14
190606	I-55	210294	J-88	1AA*FJC*	H-14	1BA*FR*	H-18
190607	I-55	221501	J-70	1AA*FR*	H-18	1BA*FRA*	H-19
190608	I-55	222005	K-2	1AA*FRA*	H-19	1BA*FRB*	H-20
190609	I-55	222022	K-2	1AA*FRB*	H-20	1BA*FRC*	H-21
190672	I-49	479301	I-54	1AA*FRC*	H-21	1BA*FS*	H-16
190718	I-59	479501	I-54	1AA*FS*	H-16	1BA*MB*	H-17
190742	I-59	479601	I-55	1AA*MB*	H-17	1BA*MJ*	H-15
190772	I-58	500023	J-85	1AA*MF*	H-24	1BA*MP*	H-5
190773	I-58	500024	J-86	1AA*MFA*	H-25	1BA*MR*	H-22
190800	I-54	500025	J-84	1AA*MFB*	H-25	1G*BF*	H-26
190846	I-8	500454	J-72	1AA*MJ*	H-15	1G*BFA*	H-28
190933	I-41	504089	J-87	1AA*MP*	H-5	1G*BFB*	H-29
190934	I-41	504095	J-72	1AA*MR*	H-22	1G*BP*	H-31
190935	I-43	900564	K-2	1AA*PF*	H-7	1G*BT*	H-30
190936	I-45	900598	J-36	1AA*PS*	H-8	1G*DK*	H-35
190937	I-46	900599	J-68	1B*BF*	H-26	1G*DL*	H-32
190944	I-51	900605	J-93	1B*BFA*	H-28	1G*DLA*	H-33
190950	I-60	900705	K-2	1B*BFB*	H-29	1G*DLB*	H-34
190992	I-41	900729	K-5	1B*BT*	H-30	1G*DS*	H-36
191000	I-28	900952	K-2	1B*DL*	H-32	1G*DSA*	H-37
191395	I-9	3E80	B-48	1B*DLB*	H-34	1G*DSB*	H-38
200001	J-94	15CA Eclipse	F-5	1B*DS*	H-36	1G*EK*	H-39
202003	J-61	1A*BF*	H-26	1B*DSA*	H-37	1G*FL*	H-42
202113	J-51	1A*BFA*	H-28	1B*DSB*	H-38	1G*FLA*	H-44
202114	J-51	1A*BFB*	H-29	1B*EK*	H-39	1G*FLB*	H-46
202124	J-94	1A*BP*	H-31	1B*FH*	H-51	1G*FLG*	H-50
202232	J-91	1A*BT*	H-30	1B*FHA*	H-52	1G*JF*	H-40
202411	J-56	1A*DK*	H-35	1B*FHB*	H-54	1G*JM*	H-27
202413	J-56	1A*DL*	H-32	1B*FHD*	H-51	1G*KF*	H-41
202414	J-57	1A*DLA*	H-33	1B*FHE*	H-53	1G*KS*	H-55
202702	J-76	1A*DLB*	H-34	1B*FHF*	H-52	1G*KSA*	H-55
202702	J-77	1A*DS*	H-36	1B*FHG*	H-53	1G*SL*	H-23
202712	J-68	1A*DSA*	H-37	1B*FL*	H-42	1GA*FJ*	H-9
202713	J-77	1A*DSB*	H-38	1B*FLA*	H-44	1GA*FJ*	H-10
202901	J-60	1A*EK*	H-39	1B*FLB*	H-46	1GA*FJA*	H-11
203002	J-73	1A*FL*	H-42	1B*FLD*	H-48	1GA*FJB*	H-12
203003	J-80	1A*FLA*	H-44	1B*FLE*	H-49	1GA*FJC*	H-14
203005	J-80	1A*FLB*	H-46	1B*FLF*	H-49	1GA*FR*	H-18
203006	J-60	1A*FLD*	H-48	1B*FLG*	H-50	1GA*FRA*	H-19
203007	J-58	1A*FLE*	H-49	1B*JF*	H-40	1GA*FRB*	H-20
203008	J-74	1A*FLG*	H-50	1B*JM*	H-27	1GA*FRC*	H-21
203101	J-74	1A*JF*	H-40	1B*KF*	H-41	1GA*FS*	H-16
203102	J-74	1A*JM*	H-27	1B*KS*	H-55	1GA*MB*	H-17
203103	J-59	1A*KDB*	H-56	1B*KSA*	H-55	1GA*MF*	H-24
203104	J-60	1A*KF*	H-41	1B*KSB*	H-56	1GA*MFA*	H-25
203301	J-59	1A*KS*	H-55	1B*SL*	H-23	1GA*MFB*	H-25
206209	J-78	1A*KSA*	H-55	1BA*FJ*	H-9	1GA*MJ*	H-15
206801	J-66	1A*SL*	H-23	1BA*FJ*	H-10	1GA*MP*	H-5
206804	J-66	1AA*FJ*	H-9	1BA*FJA*	H-11	1GA*MR*	H-22

Index

Part number index

M

Part number	page	Part number	page	Part number	page	Part number	page
1GA*PF*	H-7	2027-x	L-24, L-25	4S*DL*	H-75	6S*CTD*	H-69
1GA*PS*	H-8	2040-x	L-24, L-25	4S*DLB*	H-75	6S*CTE*	H-71
1S*BF*	H-26	2081-x	L-24, L-25	4S*DS*	H-76	6S*CTF*	H-70
1S*BFA*	H-28	2082-x	L-24, L-25	4S*DSA*	H-77	6S*CTG*	H-71
1S*BFB*	H-29	2550/2554	F-15	4S*DSB*	H-77	6S*DS*	H-76
1S*BP*	H-31	2556/2565	C-5	4S*EK*	H-76	6S*DSA*	H-77
1S*BT*	H-30	259-1290	J-106	4S*EK*	H-39	6S*DSB*	H-77
1S*DK*	H-35	259-2021	J-104	4S*FH*	H-66	6S*FH*	H-66
1S*DL*	H-32	259-2022	J-104	4S*FHA*	H-67	6S*FHA*	H-67
1S*DLA*	H-33	259-2027	J-105	4S*FHB*	H-68	6S*FHB*	H-68
1S*DLB*	H-34	259-202702	J-105	4S*FHD*	H-66	6S*FHG*	H-67
1S*DS*	H-36	259-2081	J-102	4S*FHE*	H-68	6S*FL*	H-63
1S*DSA*	H-37	259-2082	J-102	4S*FHF*	H-67	6S*FLA*	H-64
1S*DSB*	H-38	259-2083	J-103	4S*FHG*	H-67	6S*FLB*	H-65
1S*EK*	H-39	259-2096	J-103	4S*FL*	H-63	6SA*FJ*	H-58
1S*FH*	H-51	259-2240	J-104	4S*FLA*	H-64	6SA*FJA*	H-58
1S*FL*	H-42	259-4721	I-27	4S*FLB*	H-65	6SA*FJB*	H-59
1S*FLA*	H-44	259-900605	J-106	4S*FLD*	H-63	6SA*FR*	H-61
1S*FLB*	H-46	30CT	B-49, B-52	4S*FLE*	H-65	6SA*FRA*	H-61
1S*FLD*	H-48	3270 Eclipse	F-8	4S*FLE*	H-64	6SA*FRB*	H-62
1S*FLE*	H-49	35FH	F-13	4S*FLG*	H-64	6SA*MP*	H-57
1S*FLG*	H-50	35NG	F-27	4S*FLH*	H-66	7015x	J-113
1S*JF*	H-40	37AL	B-46, B-52	4S*JF*	H-75	7105x	J-112
1S*JM*	H-27	38-190627	I-57	4S*KF*	H-75	7129x	J-113
1S*KF*	H-41	38-190628	I-60	4S*KSB*	H-56	7165x	J-112
1S*KS*	H-55	38-191074	I-59	4S*SL*	H-23	7205x	J-115
1S*KSA*	H-55	3R80	B-47	4SA*FJ*	H-58	7229x	J-113
1S*KSB*	H-56	3SCE Eclipse	F-5	4SA*FJA*	H-58	7255x	J-115
1S*SL*	H-23	3V10	B-50	4SA*FJB*	H-59	7305x	J-114
1SA*FJ*	H-9	3VE0	B-51	4SA*FJC*	H-59	7306x	J-114
1SA*FJ*	H-10	4245 Eclipse	F-6	4SA*FJG*	H-59	7315x	J-116
1SA*FJA*	H-11	4247 Solstice	F-7	4SA*FR*	H-61	7325x	J-114
1SA*FJB*	H-12	44-411	I-14	4SA*FRA*	H-61	7355x	J-116
1SA*FJC*	H-14	44-412	I-4	4SA*FRB*	H-62	7405x	J-117
1SA*FR*	H-18	4523-04005	L-23	4SA*FRC*	H-62	7455x	J-117
1SA*FRA*	H-19	4523-04005	L-23	4SA*FS*	H-60	7505x	J-116
1SA*FRB*	H-20	4523-04006	L-23	4SA*MB*	H-60	7515x	J-118
1SA*FRC*	H-21	4573-00000	L-23	4SA*MJ*	H-57	7605x	J-120
1SA*FS*	H-16	4KGEN	F-11	4SA*MP*	H-57	7655x	J-120
1SA*MB*	H-17	4S*BF*	H-73	4SA*MR*	H-60	7705x	J-118
1SA*MF*	H-24	4S*BFA*	H-73	4SA*PS*	H-57	7716x	J-119
1SA*MFA*	H-25	4S*BFB*	H-74	63-190535	I-60	7755x	J-118
1SA*MFB*	H-25	4S*BP*	H-72	63-190600	I-57	7805x	J-119
1SA*MJ*	H-15	4S*BT*	H-72	63-190626	I-59	8112x	J-112
1SA*MP*	H-5	4S*CT*	H-69	63-190990	I-58	8165x	J-112
1SA*MR*	H-22	4S*CTA*	H-70	6S*BF*	H-73	900599-x	L-24, L-25
1SA*PF*	H-7	4S*CTB*	H-72	6S*BFA*	H-73	CR170	F-26
1SA*PS*	H-8	4S*CTD*	H-69	6S*BFB*	H-74	EC038	F-14
2000-x	L-24, L-25	4S*CTE*	H-71	6S*CT*	H-69	EC230	B-35
2001-6-x	L-24, L-25	4S*CTF*	H-70	6S*CTA*	H-70	EC502	B-33
2021-x	L-24, L-25	4S*CTG*	H-71	6S*CTB*	H-72	EC525	B-16

Part number	page	Part number	page	Part number	page	Part number	page
EC600	B-20	ET5040C-0006	L-11	ET9200-10-220	L-15	ET9500C-10-MS	L-17
EC810	B-19	ET5040C-0007	L-10	ET9200-10-220-3	L-15	ET9500C-10-SC	L-17
EC850	B-21	ET5040C-0007	L-11	ET9200-10-22050	L-15	ET9500C-10-SL	L-17
EC910	B-41	ET5040C-0009	L-10	ET9200-10-24V	L-15	ET9500C-10-SM	L-16
EH084	D-9	ET5040C-0014*	L-10	ET9200-10-440-3	L-15	ET9500C-12-1-MS	L-17
EH225	F-16	ET5040C-0014*	L-11	ET9200C-10-1-MS	L-17	ET9500C-12-1-SL	L-17
EH226	F-17	ET5040C-0016	L-10	ET9200C-10-1-SL	L-17	ET9500C-12-1-SM	L-16
EH227	F-18	ET5040C-0016	L-11	ET9200C-10-AS	L-16	ET9500C-12-AS	L-16
EH920	D-5	ET5040C-0019	L-10	ET9200C-10-D	L-16	ET9500C-12-MS	L-17
EHA500	D-2	ET5040C-0019	L-11	ET9200C-10-MS	L-17	ET9500C-12-SC	L-17
EHN004	D-8	ET5040C-0020	L-10	ET9200C-10-SC	L-17	ET9500C-12-SL	L-17
EHP009	D-7	ET5040C-0020	L-11	ET9200C-10-SL	L-17	ET9500C-12-SM	L-16
EHW028	D-2	ET5040C-0022	L-10	ET9200C-10-SM	L-16	ET9500C-14-AS	L-16
EHW028	D-10	ET5040C-0022	L-11	ET9300-14-220	L-15	ET9500C-14-MS	L-17
EHW029	D-10	ET5040C-0023	L-10	ET9300-14-220-3	L-15	ET9500C-14-SC	L-17
EJ3619	H-85	ET5040C-0023	L-11	ET9300-14-220-3 CSA	L-15	ET9500C-14-SL	L-17
EJ3932	H-84	ET5040DC-M320S	L-10	ET9300-14-22050	L-15	ET9500C-14-SM	L-16
EJ3998	H-83	ET5040DC-M320S†	L-11	ET9300-14-440-3	L-15	ET9500C-16-MS	L-17
EJ5041	H-85	ET5040DC-MXXX	L-10	ET9300C-14-AS	L-15	ET9500C-16-SL	L-17
EJ5611	H-85	ET5040DC-Mxxx	L-12	ET9300C-14-AS	L-16	ET9500C-16-SM	L-16
EJ7257	H-85	ET5040DC-MXXX	L-11	ET9300C-14-D	L-15	ET9500C-18-MS	L-17
EJ7537	H-83	ET5040PBL	L-13	ET9300C-14-D	L-16	ET9500C-18-SL	L-17
ET1187-001	L-4	ET5040PBL-MXXX	L-10	ET9300C-14-MS	L-15	ET9500C-18-SM	L-16
ET1187-002	L-4	ET5040PBL-Mxxx	L-13	ET9300C-14-MS	L-17	ET9500C-20-1-SL	L-17
ET1280	L-6	ET5040PBL-MXXX	L-11	ET9300C-14-SC	L-15	ET9500C-20-MS	L-17
ET1280-001	L-6	ET5050	L-11	ET9300C-14-SL	L-15	ET9500C-20-SL	L-17
ET1280-005	L-6	ET5050-001-230	L-11	ET9300C-14-SL	L-17	ET9500C-20-SM	L-16
ET4001C-0017	L-10	ET5050-001-230KT	L-11	ET9300C-14-SM	L-15	ET9500C-21-SL	L-17
ET4001C-0017	L-11	ET5050-001-380	L-11	ET9300C-14-SM	L-16	ET9500C-22-MS	L-17
ET5040	L-10	ET5050-001-380KT	L-11	ET9500C-06-AS	L-16	ET9500C-22-SL	L-17
ET5040 DC	L-12	ET5050-001-400	L-11	ET9500C-06-MS	L-17	ET9500C-22-SM	L-16
ET5040-001-230	L-10	ET5050-001-400KT	L-11	ET9500C-07-AS	L-16	ET9500C-24-MS	L-17
ET5040-001-230KT	L-10	ET5050-001-420	L-11	ET9500C-07-MS	L-17	ET9500C-24-SL	L-17
ET5040-001-380	L-10	ET5050-001-420KT	L-11	ET9500C-07-SC	L-17	ET9500C-24-SM	L-16
ET5040-001-380KT	L-10	ET5050-001-440	L-11	ET9500C-07-SL	L-17	ET9500C-26-MS	L-17
ET5040-001-400	L-10	ET5050-001-440KT	L-11	ET9500C-07-SM	L-16	ET9500C-26-SL	L-17
ET5040-001-400KT	L-10	ET5050-001-460	L-11	ET9500C-08-AS	L-16	ET9500C-26-SM	L-16
ET5040-001-420	L-10	ET5050-001-460KT	L-11	ET9500C-08-MS	L-17	F2015	L-22
ET5040-001-420KT	L-10	ET5050-001-480	L-11	ET9500C-08-SC	L-17	FC1102	J-90
ET5040-001-440	L-10	ET5050-001-480KT		ET9500C-08-SL	L-17	FC1132	J-90
ET5040-001-440KT	L-10	ET5050-009	L-11	ET9500C-08-SM	L-16	FC1229	J-18
ET5040-001-460	L-10	ET9100-07-110	L-14	ET9500C-10-1-AS	L-16	FC1851	J-17
ET5040-001-460KT	L-10	ET9100-07-22050	L-14	ET9500C-10-1-MS	L-17	FC2119	I-63
ET5040-001-480	L-10	ET9100-07-22060	L-14	ET9500C-10-1-SC	L-17	FC2119	H-89
ET5040-001-480KT	L-10	ET9100C-07-AS	L-16	ET9500C-10-1-SL	L-17	FC2325	J-18
ET5040C-0001	L-12	ET9100C-07-MS	L-17	ET9500C-10-1-SM	L-16	FC2326	J-20
ET5040C-0001*†	L-10	ET9100C-07-SC	L-17	ET9500C-10-2-MS	L-17	FC234	F-23
ET5040C-0001*†	L-11	ET9100C-07-SL	L-17	ET9500C-10-2-SL	L-17	FC254	B-36
ET5040C-0004*	L-10	ET9100C-07-SM	L-16	ET9500C-10-2-SM	L-16	FC2716	H-79
ET5040C-0004*	L-11	ET9200-10-1-SM	L-16	ET9500C-10-3-SL	L-17	FC273B	B-18
ET5040C-0006	L-10	ET9200-10-12V	L-15	ET9500C-10-AS	L-16	FC2875	J-92

Index

Part number index

M

Part number	page	Part number	page	Part number	page	Part number	page
FC300	F-24	FC5985	I-38	FC800	E-5	FF2001T	J-27
FC310	B-26	FC5986	I-38	FC802	E-4	FF2030T	J-31
FC321	F-25	FC5987	I-38	FC839B	B-8	FF2031T	J-26
FC332	C-4	FC5988	I-38	FC849	B-24	FF2032T	J-27
FC350	F-21	FC5989	I-38	FC849B	B-25	FF2033T	J-32
FC355	F-20	FC5990	I-39	FC9034	I-46	FF2035T	J-30
FC425	K-3	FC5991	I-39	FC9062	I-59	FF2068T	J-24
FC466	C-7	FC5992	I-39	FC9063	I-60	FF2093T	J-26
FC498	C-6	FC5993	I-39	FC9066	I-45	FF2098T	J-30
FC500	B-17	FC606	B-38	FC9171	I-58	FF2114T	J-32
FC5060	I-45	FC611	B-31	FC9188	I-46	FF2115T	J-20
FC5075	I-18	FC619	B-42	FC9341	I-58	FF2130T	J-21
FC5098	H-79	FC636	B-40	FC9459	I-44	FF2133T	J-29
FC510	B-27	FC639	B-22	FC9634	I-44	FF2138	J-36
FC5130	I-20	FC647	C-4	FC9726	I-19	FF2144T	J-30
FC5131	I-20	FC650	F-22	FC9779	H-78	FF2174T	J-31
FC5133	I-20	FC693	B-32	FC9846	H-78	FF2209T	J-28
FC5135	I-22	FC699	F-22	FF1010	J-35	FF2211T	J-21
FC5136	I-22	FC701	D-10	FF1159	J-67	FF2227T	J-23
FC5137	I-22	FC702	D-10	FF1162	J-44	FF2281T	J-29
FC5138	I-23	FC7031	I-10	FF1167	J-37	FF2313T	J-28
FC5139	I-23	FC7217	H-79	FF1315	J-88	FF2485T	J-98
FC5140	I-23	FC7220	H-79	FF13267	K-7	FF2522T	J-83
FC5141	I-23	FC7275	I-54	FF13268	K-7	FF2591	J-37
FC5142	I-21	FC735	B-11	FF13269	K-7	FF2593	J-100
FC5143	I-21	FC736	B-15	FF1327	J-94	FF2742T	J-98
FC5144	I-21	FC7370	I-43	FF13270	K-7	FF2743T	J-98
FC5379	I-21	FC7371	I-44	FF13271	K-7	FF2744T	J-98
FC5380	I-22	FC7372	I-45	FF13272	K-7	FF2746T	J-98
FC5432	I-37	FC7373	I-45	FF13273	K-7	FF5162	J-86
FC555	E-6	FC7374	I-46	FF1353	J-94	FF5163	J-72
FC579	B-34	FC740	G-10	FF1354	J-94	FF5164	J-73
FC5847	I-50	FC7639	I-41	FF13570	K-7	FF5238	J-85
FC5848	I-50	FC7640	I-41	FF13571	K-7	FF5239	J-84
FC5849	I-50	FC7703	I-46	FF16087-01	I-65	FF5321	J-87
FC5852	I-51	FC7713	I-43	FF16087-01	H-91	FF5539	J-85
FC5853	I-48	FC7714	I-44	FF1851T	J-19	FF5540	J-87
FC5954	I-16	FC7715	I-45	FF1852T	J-22	FF5541	J-84
FC5973	I-43	FC7740	I-41	FF1854T	J-21	FF593	I-62
FC5974	I-44	FC7790	I-44	FF1856T	J-20	FF593	H-88
FC5975	I-44	FC7811	I-46	FF1857T	J-32	FF5943T	J-81
FC5976	I-45	FC7983	I-44	FF1858T	J-20	FF5945T	J-82
FC5977	I-45	FC7984	I-46	FF1861T	J-25	FF5946T	J-82
FC5978	I-41	FC7985	I-17	FF1865T	J-25	FF595	I-62
FC5979	I-41	FC7986	I-17	FF1868T	J-23	FF595	H-88
FC598	C-6	FC7987	I-17	FF1898T	J-31	FF6001T	J-81
FC5980	I-42	FC7988	I-17	FF1922T	J-19	FF6002T	J-81
FC5981	I-42	FC7989	I-17	FF1980	J-95	FF6062T	J-82
FC5982	I-42	FC7990	I-18	FF1981	J-95	FF6063T	J-82
FC5983	I-42	FC7991	I-18	FF1994T	J-29	FF6064T	J-82
FC5984	I-42	FC7992	I-18	FF2000T	J-28	FF6071T	J-83

Part number	page	Part number	page	Part number	page	Part number	page
FF6072T	J-83	FJ7023	I-53	FT1033-x	L-21	FT1390-23050	L-7
FF6073T	J-83	FJ7044	I-51	FT1038A	L-22	FT1390-23060	L-7
FF90102	J-17	FJ7199	I-19	FT1038B	L-22	FT1455	L-26
FF90103	J-17	FJ7200	I-40	FT1058	L-25	FT1455-CC	L-31
FF90146	J-17	FJ7201	I-25	FT1081	L-23	FT1455-J-XX	L-29
FF9016	I-63	FJ7202	I-25	FT1081-16	L-23	FT1455-J-XX	L-29, L-33
FF9016	H-89	FJ7203	I-25	FT1081-20	L-23	FT1455-J-xx	L-32
FF90311	K-5	FJ7204	I-25	FT1081-3-x	L-23	FT1455-K1	L-28
FF90319	I-64	FJ7286	I-47	FT1092	L-7	FT1455-K2	L-28
FF90319	H-90	FJ7344	I-39	FT1097	L-19	FT1455-K3	L-28
FF9075	J-34	FJ7345	I-40	FT1097-2-1	L-19	FT1455-K4	L-28
FF90754	K-4	FJ7346	I-40	FT1209-2-9	L-9	FT1455-K5	L-28
FF9173	J-88	FJ7347	I-40	FT1220-10	L-22	FT1455-L1	L-27
FF9217	K-3	FJ7358	I-53	FT1229-x	L-18	FT1455-L2	L-27
FF9446	I-66	FJ9024	I-42	FT1230-x	L-18	FT1455-L2-AR1	L-30
FF9446	H-89	FJ9025	I-42	FT1231-x	L-18	FT1455-L3	L-27
FF9446	H-92	FJ9026	I-42	FT1234-x	L-21	FT1455-L3-AR2	L-30
FF9605	J-92	FJ9027	I-43	FT1240-100-x	L-18	FT1455-L3-AR3	L-30
FF9766	J-34	FJ9028	I-43	FT1240-150-x	L-18	FT1455-L3-LR	L-30
FF9767T	J-33	FJ9033	I-46	FT1261	L-24	FT1455-L4	L-27
FF9768	J-33	FJ9064	I-37	FT1279	L-18	FT1455-N-45	L-29
FF9807	I-66	FJ9065	I-37	FT1281	L-20	FT1455-N-HXX	L-29
FF9807	H-92	FJ9066	I-37	FT1283	L-7	FT1455-N-Hxx	L-29, L-32
FF9855	I-66	FJ9068	I-48	FT1307-200-x	L-7	FT1455-N-U55	L-29, L-33
FF9855	H-92	FJ9486	I-48	FT1307-2-9	L-9	FT1455-N-UXX	L-33
FF9863	J-33	FJ9706	I-6	FT1307-200-R5-xx	L-9	FT1455-NH25	L-31
FF9895	I-65	FJ9707	I-6	FT1310-2-9	L-6	FT1455-NT-XX	L-29
FF9895	H-91	FJ9708	I-6	FT1312	L-24	FT1455-NT-XX	L-29, L-33
FJ3094	H-80	FJ9709	I-15	FT1330-XL	L-7	FT1455-NT-XXXXX	L-29
FJ3114	H-80	FJ9724	I-19	FT1355-A-XX	L-33, L-36, L-37	FT1455-QC	L-31
FJ3152	H-82	FJ9725	I-19	FT1355-H-XX	L-33, L-35, L-37, L-38	FT1555	L-39, L-42
FJ3243	H-81	FJ9727	I-19	FT1355-T-XX	L-33, L-34, L-36, L-37	FT1555-BM	L-40
FJ3244	H-81	FJ9728	I-24	FT1380	L-5	FT1555-HH	L-40
FJ3245	H-82	FJ9729	I-24	FT1380-275-R5-xx	L-8	FT1555-HH-D15	L-42
FJ3246	H-81	FJ9730	I-24	FT1380-4	L-5	FT1555-HH-D20	L-42
FJ3247	H-81	FJ9731	I-24	FT1380-4	L-6	FT1555-HH-ST	L-42
FJ3248	H-82	FJ9732	I-32	FT1380-115	L-5	FT1555-K1	L-41
FJ3249	H-81	FJ9733	I-33	FT1380-115-5	L-6	FT1555-K2	L-41
FJ3250	H-81	FJ9734	I-33	FT1380-115-8	L-6	FT1555-K3	L-41
FJ3251	H-82	FJ9735	I-33	FT1380-2-3	L-5	GG106-NP	J-99
FJ3254	H-84	FJ9740	I-47	FT1380-2-3	L-6	GG108-NP	J-97
FJ3255	H-84	FJ9741	I-47	FT1380-2-4	L-5	GG110-NP	J-100
FJ3468	H-83	FJ9742	I-47	FT1380-2-4	L-6	GG306-NP	J-100
FJ3549	H-86	FJ9743	I-47	FT1380-2-9	L-8	GG308-NP	J-97
FJ3550	H-86	FJ9744	I-47	FT1380-2-9A	L-8	GG310-NP	J-100
FJ3551	H-86	FJ9745	I-47	FT1380-275-Mxxx	L-8	GH001	E-3
FJ3552	H-86	FJ9746	I-47	FT1380P-2-2	L-6	GH100 ESP	F-19
FJ3566	H-86	FJ9747	I-47	FT1390	L-7	GH101 ESP	F-19
FJ4649	I-56	FT1013-1-x	L-20	FT1390-200-x	L-7	GH120	B-13
FJ4650	I-56	FT1013-2-x	L-20	FT1390-115	L-7	GH194	B-9
FJ4709	I-56	FT1028	L-21	FT1390-2-9	L-9	GH195	B-12

Index

Part number index

M

Part number	page	Part number	page	Part number	page	Part number	page
GH466	B-39	H0364	D-10	H201.....	C-3	HP4, HP6, HP8, HPM.....	K-6
GH493	B-14	H0372.....	D-8	H201.....	D-2	HP6.....	K-6
GH506	B-37	H0377.....	D-7	H275.....	D-2	HP8.....	K-6
GH663	B-23	H0378.....	D-3	H285.....	D-4	HPM.....	K-6
GH681	B-7	H0521.....	D-6	H345.....	D-10	HSM-48.....	K-6
GH781	B-10	H0523.....	D-3	H6009.....	D-2	NF-TW.....	F-28
GH793	B-28	H057.....	F-12	H8811.....	D-8	O-Rings.....	I-66
H0034	D-6	H0599.....	D-3	H900.....	D-5	PT200.....	D-4
H0060	D-3	H0616.....	D-8	H901.....	D-7	S-Series.....	G-3
H0084	D-9	H1066.....	D-4	H9568.....	D-9	S-TW Series.....	G-5
H0105.....	D-2	H1193.....	D-7	H9603.....	D-8	SC-Series.....	G-4
H0106.....	D-2	H1196.....	D-10	H9610.....	D-4	SC-TW Series.....	G-6
H0319.....	D-6	H1776.....	D-2	H9673.....	D-4	T-191.....	L-23
H0345.....	D-3	H1777.....	D-2	H9690.....	D-8	T-191B.....	L-23
H0346.....	D-3	H1812.....	D-2	H9690.....	D-9	T-480-3.....	L-6
H0347.....	D-6	H1941.....	D-3	H9949.....	D-2	T1307-200-Mxxx.....	L-9
H0349.....	D-6	H1942.....	D-3	HI-PSI Series.....	G-7		
H0350.....	D-4	H1981.....	D-2	HLM-48.....	K-6		
H0363.....	D-7	H1982.....	D-2	HP4.....	K-6		

Eaton
Hydraulics Group USA
14615 Lone Oak Road
Eden Prairie, MN 55344
USA
Tel: 952-937-9800
Fax: 952-294-7722
www.eaton.com/hydraulics

Eaton
Hydraulics Group Europe
Route de la Longeraie 7
1110 Morges
Switzerland
Tel: +41 (0) 21 811 4600
Fax: +41 (0) 21 811 4601

Eaton
Hydraulics Group Asia Pacific
Eaton Building
4th Floor, No.7 Lane280 Linhong Rd.
Changning District
Shanghai 200335
China
Tel: (+86 21) 5200 0099
Fax: (+86 21) 2230 7240